

# **MAJOR TIRE MACHINE**

USE AND MAINTENANCE version 1.0.8

# 1. CONTROL PANEL

The machine control panel is shown in Figure F1. The control panel allows the operator to give commands and enter or modify data. The same control panel displays the balancing results and machine messages. The functions of the various sections of the control panel are described in table T1. The rear side of the control panel contains the CPU-C1 electronic control board that collects, processes and displays data.

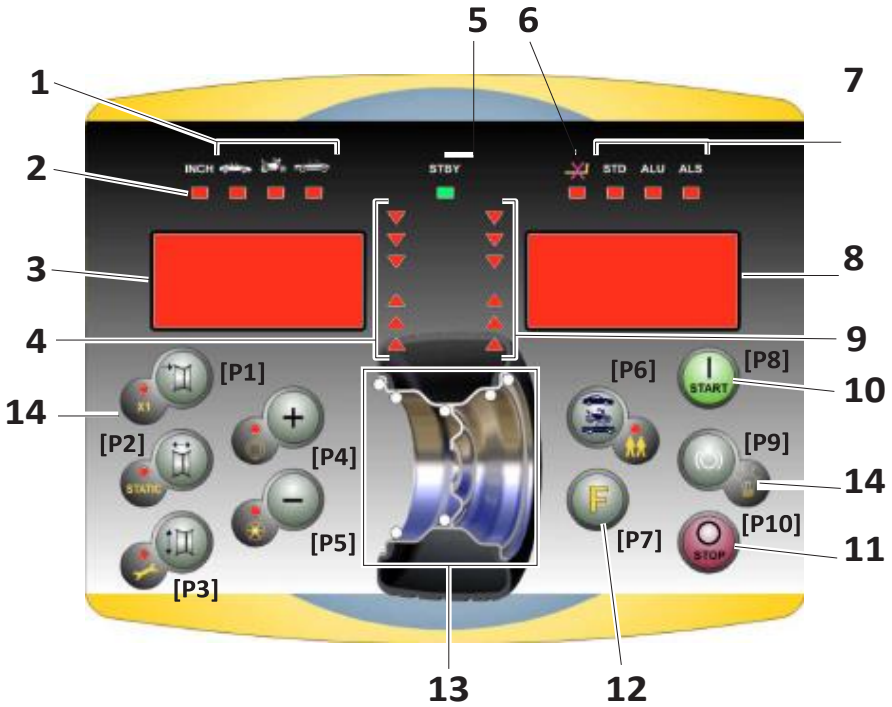


Figure F1: Control Panel.




**Table T1 Functions of different parts of the control panel**

Position	Description
1	Indicator light for the selected CAR/MOT/SUV (Auto-vehicle/Motorbike/Off-road) Wheel Type. Group of three indicator lights (red) indicating the Type of programme selected
2	Indicator light (red) for the selected unit of measure: inches (on) - mm (off).
3 – 8	Display for viewing internal-external imbalance
4 - 9	Indicator light for the internal-external angular imbalance position
5	Active standby status indicator light
6	Enabling (on) - disabling (off) indicator light of the automatic acquisition system of the wheel size
7	Indicator light for the selected Programme Type (Standard/Alu/Alu S). Group of three indicator lights (red) indicating the Type of programme selected.
10	Start key to start the motor
11	Stop key to stop the motor
12	F key to access the secondary functions of the keys
13	Indicator light of the Weight Imbalance Position. Group of 7 LEDs (red). The position depends on the Type of Programme and the Type of Wheel selected.
14	Example of standard key: it features a main function (indicated in the big circle) and a secondary function (indicated in the small circle)

### 1.1 Keypad


In this manual, the keys are numbered for convenience from [P1] to [P10] as shown in Figure F1. In addition to the reference numbers of the key, the icons of the same keys are displayed to facilitate reading.

The ten buttons have a main function indicated by a symbol in the big circle, and a secondary function indicated by the symbol in the small circle located alongside. Some of the secondary functions feature a LED

to indicate their activation. The keys [P7] , [P8] Start  and [P10] Stop  do not have a secondary function. The secondary function of the keys is identified in this manual with the codes from [F+P1] to [F+P9] as shown in Figure 1b.



**Figure F1a: Example of a key with the indication of the first and secondary functions**

To access the secondary function of a key, press the key [P7]  together with one of the keys for which you want the secondary function simultaneously and then release both the keys.

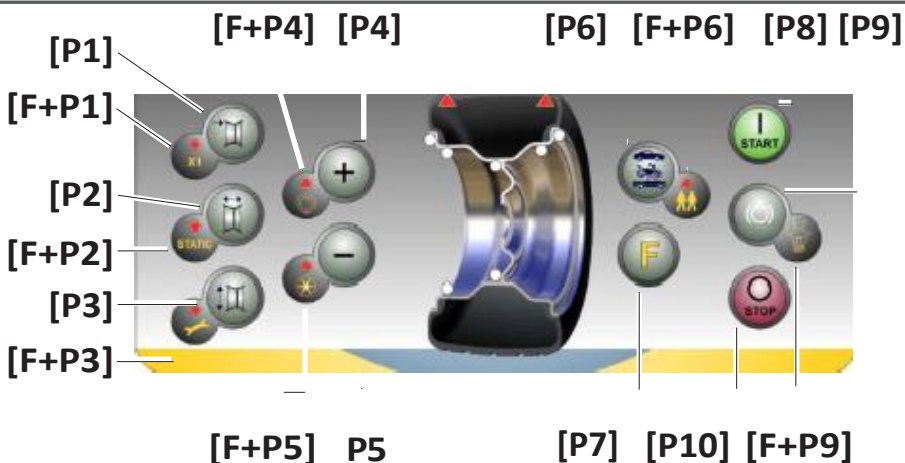


Figure F1b: Numbering of the secondary functions of the keys

Table T1a, Settings, programmes and Menu available in the SERVICE mode, press F+P3 to enter SERVICE mode

SERVICE mode			
Key	Setting/programme or Menu	Key	Setting/programme or Menu
[P1]	MENU Programme for sensor calibration	[F+P1]	Not used
[P2]	Not used	[F+P2]	Select weight material in Fe/Zn, or Pb
[P3]	Machine calibration	[F+P3]	Exit SERVICE mode (return to the NORMAL mode)
[P4]	Select grams/ounces	[F+P4]	Read counter with the no. of launches
[P5]	Select inches/mm	[F+P5]	Parameters MENU (Menu with password reserved for technical service)
[P6]	Select the imbalances threshold view	[F+P6]	USB port Not used
[P9]	Not used	[F+ P9]	Test Programmes MENU

**Note:**






 the keys [P7] , [P8] Start and [P10] Stop are not used to access settings, programmes or Menus.



The keys [P8] Start and [P10] Stop have different effects depending on the position of the wheel guard as indicated in table T1b.

**Table T1b - Effects of the Start and Stop keys in relation to the state of the wheel guard**

Button pressed	Wheel guard position	Result
[P8] Start 	HIGH	<ul style="list-style-type: none"> <li>if the clamping brake is disabled, the machine will not run the launch and emits three beeps meaning that the requested action is not possible;</li> <li>if the position brake is enabled and imbalances are displayed, the machine will run the launch at low speed (SWI procedure. See chapter 8.5 <i>SWI wheel stop procedure on the positions of imbalance</i>)</li> </ul> <p>NOTE: for operator safety purposes, the SWI procedure will not be run when the MOTO Wheel Type is active.</p>
	LOW	The machine will run the balancing or testing launch
[P10] Stop 	HIGH	No action.
	LOW	<ul style="list-style-type: none"> <li>No action if the wheel is spinning;</li> <li>Spinning stops if this is in progress</li> </ul>

## 1.2 NORMAL, SERVICE, STAND-BY operating modes

The machine features three operating modes:

- **NORMAL** mode. This mode is enabled when the machine is switched on and allows the use of the machine to run wheel balancing;
- **SERVICE** mode. In this mode, there are a number of utility programmes available to enter settings (e.g. unit of measure in grams or ounces) or controls for machine operation (such as calibration).
- **STAND-BY** mode. After 5 minutes of inactivity, the machine automatically switches to the STAND-BY mode to reduce power consumption. The green STBY LED present on the control panel flashes to indicate that the machine is in this mode. To exit the STAND-BY mode, press any button (with the exception of [P7]

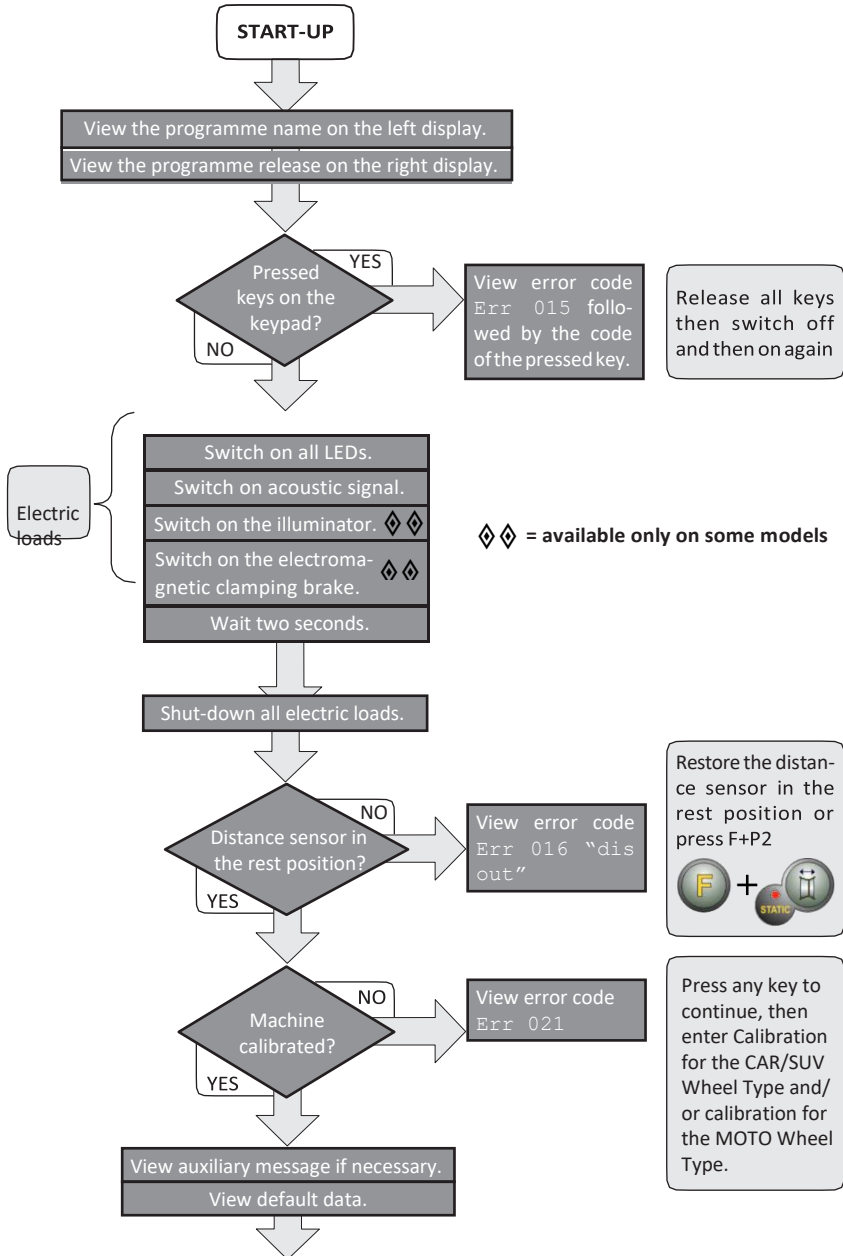


). All data and settings are maintained in the STAND-BY mode. In SERVICE mode, the machine will not switch to the STAND-BY mode.

## 2. MACHINE START-UP - DIAGNOSTICS

Once the machine is started, it runs the actions shown in diagram below.

Diagram - Programme flow at machine start-up



Machine is ready to operate.

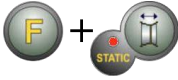
---

---

## 2.1 Temporary disabling of the diameter and distance sensor (where applicable)

If the machine displays the error code **Err 016 "dis out"** (distance/diameter sensor not in the rest position) at start-up, although being in rest position, it means that an anomaly has occurred in the acquisition system.

It is however possible to immediately (and temporarily) disable the acquisition system by pressing the button



[F + P2]

. The LED [6],



located on the control panel, will light up to indicate that the automatic acquisition system is disabled and that the machine is ready for use.

Not being able to use the automatic acquisition system, sizes of the wheel must be entered manually as described in chapters 3.3.1 and 3.3.2. By switching the machine off and then on, the error code will be displayed again for which it will be necessary to repeat the procedure described above.

## 3. USE OF THE MACHINE

To use the machine, you must select or set as follows:

- Programme type (programme for wheels with steel, aluminium or special aluminium rims).  
Default = programme for wheels with steel rims;
- Wheel Type (auto-vehicle, motorbike, off-road). Default = auto-vehicle;
- Dimensions of the wheel to balance. The dimensions can be entered manually (always) or partially or fully in automatic (only available on some models).
- Dynamic or Static balancing. Default = Dynamic;
- Display resolution X1 or X5. Default = X5;

The selections described above may be entered before or after the launch. For any variation of the selection or data settings, the machine will run a recalculation by displaying the new values of imbalance.



Once the selections/settings have been entered, you can run a launch by pressing [P8] Start or by lowering the wheel guard.

At the end of the launch, the machine displays the wheel imbalance values.

Apply the weights displayed by the machine at the indicated positions and then run a second test launch. Normally, the weights should be applied at the 12 o'clock position with the exception of special programmes for ALS2 and ALS1 aluminium.





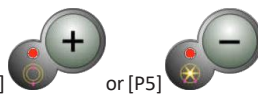
### 3.1 Type of Programme (Programme Type)

The machine allows the choice between eight different Programme Types of Balancing Programmes as listed in table T3.1

**Table T3.1 - Programme Types available**

Programme type	Wheel material	Weight position along the rim section	Automatic acquisition <sup>(1)</sup>	Notes
STD	Steel	Default	2 sensors	Start-up default
ALU1	Aluminium	Default	2 sensors	Forcibly set when the Motorbike Programme Type is selected.
ALU2	Aluminium	Default	2 sensors	
ALU3	Aluminium	Default	2 sensors	
ALU4	Aluminium	Default	2 sensors	
ALU5	Aluminium	Default	2 sensors	
ALS1	Aluminium	Default for the internal weight, provided by the user for the external weight	1 sensor	
ALS2	Aluminium	Provided by the user	1 sensor	

(1) Available only for some versions



Programmes are selected in the NORMAL mode by pressing the buttons [P4] or [P5]. At the first selection of one of these two buttons, the currently selected Programme Type will appear on the display; if within about 1.5 seconds, one of these two buttons is not pressed again, the display will return to the previous state without editing the running Programme Type.

Depending on the running Programme Type, the following LEDs are lit on the control panel:

- Programme type LED See figure F1, detail [7].
- Weight Imbalance Position LED. See figure F1, detail [13].

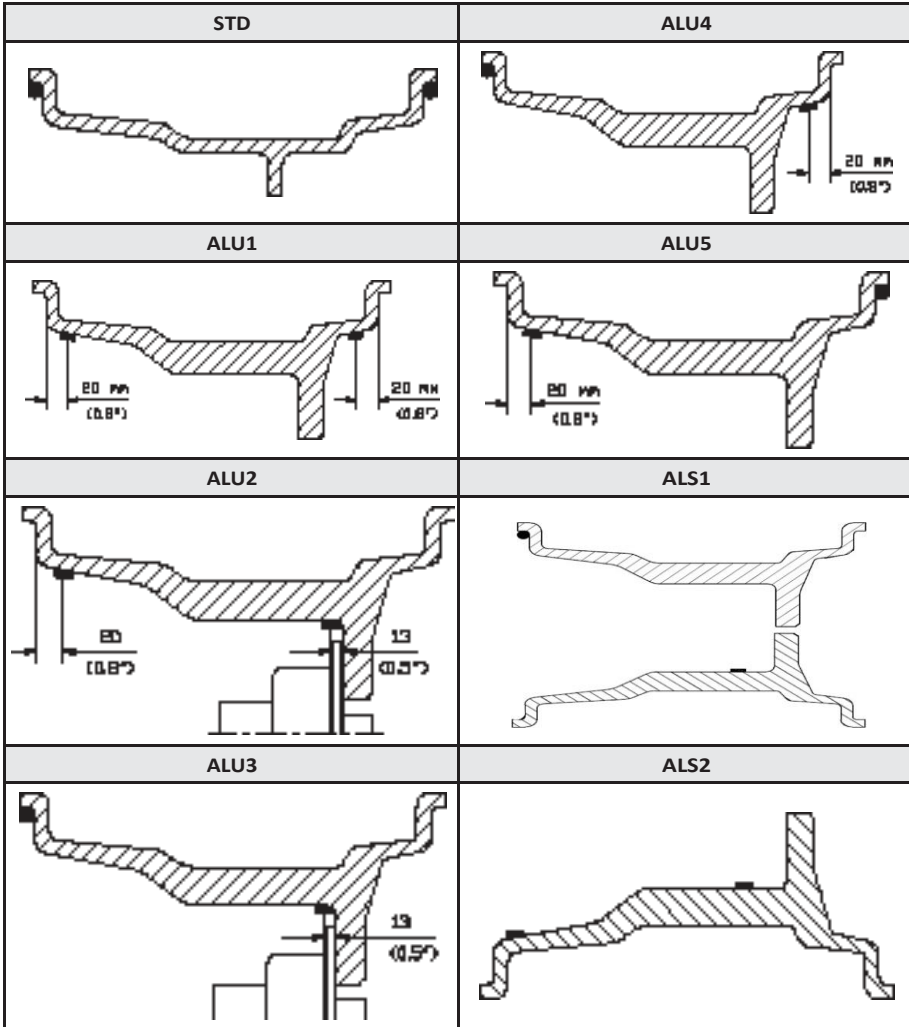
#### **Note:**

*The selection of the STD Programme Type removes the selection of the Static imbalance display.*

The selected Programme Type also influences the automatic acquisition of wheel dimensions (feature available only on some models of the machine) as shown in the Automatic acquisition column in table T3.1. The acquisition that features only 1 sensor uses the Distance/Diameter sensor.

The position of the balancing weights along the section of the rim in the various Programme Types is shown in Figure F3.1.

Figure F3.1 - Position of the weights in the various Programme Types along the section of the rim



**Table T3.1.1 Angular position of the balancing weights in the various Programme Types**

Machine data acquisition system	Programme Type								
	STD, ALU1,2,3,4,5			ALS1			ALS2		
	Internal Plane	External Plane	Static Plane	Internal Plane	External Plane	Static Plane	Internal Plane	External Plane	Static Plane
<b>Manual</b>	H12	H12	H12	H12	H6	H6	H6	H6	H6
<b>Semi-automatic</b>	H12	H12	H12	H12	Sensor-rim contact point <sup>(1)</sup>	H6	Sensor-rim contact point <sup>(1)</sup>	Sensor-rim contact point <sup>(1)</sup>	H6
<b>Automatic</b>	H12	H12	H12	H12	Sensor-rim contact point <sup>(1)</sup>	H6	Sensor-rim contact point <sup>(1)</sup>	Sensor-rim contact point <sup>(1)</sup>	H6

Note (1): if the data acquisition system is disabled, the angular position of the weight will be in the 6 o'clock position.

In table T3.1.1, the symbol H12 indicates that the angular position of the weight is at 12 o'clock while the symbol H6 indicates that the angular position of the weight is at 6 o'clock.

\*\*\*There's laser device in the cover under the main shaft on the machine with the function which can input three values automatically. When the "LAS" is ON, the laser will light automatically at the unbalance position under ALUS mode and put the weight at H6 position. \*\*\*

The machine data acquisition systems are defined as follows:


- Manual when the data of the rim must be all entered manually;
- Semi-automatic when the Distance and Diameter data are automatically acquired via the Distance/Diameter sensor while the data on the Width must be entered manually;
- Automatic when all data of the rim is automatically acquired via the two sensors.

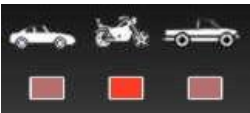

Automatic or Semi-Automatic machines with the sensors disabled (due to failure or for any other reason) become, to all intents, Manual machines. Entering the dimensions of the rims must be carried out manually and the angular position of the balancing weights will follow the procedures of the Manual machines.

### 3.2 Wheel type

The machine allows choosing between three different Wheel Types as listed in table T3.2.

**Table T3.2 - Wheel Types to select**

Wheel type	Vehicle	Notes
<p>CAR</p> 	Auto-vehicles	Start-up default

<p style="text-align: center;">MOTO</p> 	<p>Motorbikes</p>	<p>Forcibly set the ALU1 Programme Type</p>
<p style="text-align: center;">SUV</p> 	<p>Off-Road vehicles</p>	<p>Not suitable for balancing wheels of trucks</p>

Each of these programmes set specific values for the measurement of the dimensions of the wheel and the calculation of imbalances. The particularities of each programme are indicated in the following paragraphs.

To select a specific Wheel Type, press repeatedly [P6]



until the corresponding LED turns on as shown in the table T3.2.

### 3.2.1 CAR wheel type (auto-vehicles)

The selection of the CAR Wheel Type allows the balancing of wheels of auto-vehicles. For off-road vehicles, it may be appropriate to select the SUV Wheel Type (see paragraph below).

To select the CAR wheel type, press repeatedly [P6]



until the CAR LED of the Wheel Type group LED lights up. See table T3.2.

### 3.2.2 MOTO wheel type (motorbikes)



The selection of the MOTO Wheel Type allows the balancing of wheels of motorbikes. These wheels need to be mounted on the shaft of a special flange. Since the flange pushes the wheel away from the machine, you must also install a special extension for the distance sensor.



To select the MOTO wheel type, press repeatedly [P6]



until the MOTO LED of the Wheel Type group LED lights up. See table T3.2.

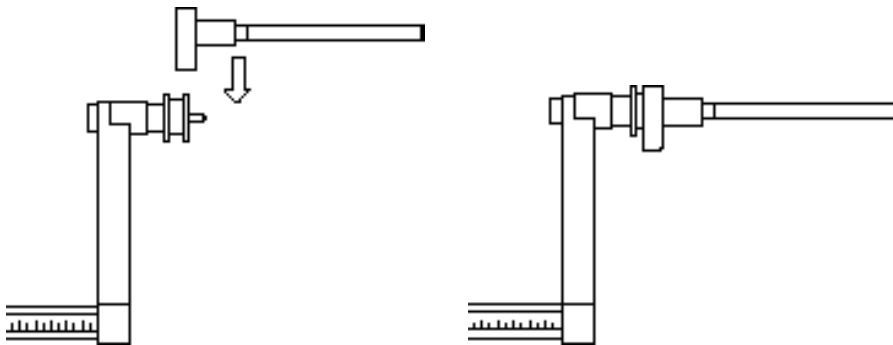
When the MOTO wheel type is enabled, the ALU1 Programme Type is automatically selected and any attempt

to select another type by pressing [P4]  or [P5]  will be rejected. The point of application of the weights along the rim section is that of the ALU1 Programme Type and is indicated in figure F3.1. When the MOTO Wheel Type is enabled, you can select the display of dynamic or static imbalance by

pressing [F+P2]  +  but if the set width of the wheel is less than 114 mm (or 4.5 inches), the static imbalance value will be always displayed.

To acquire the geometric data of the wheel automatically with the Distance/Diameter and Width sensors, you must use the same reference points on the rim of the ALU1 Programme Type.

Furthermore, when the MOTO wheel type is enabled, the current distance value is automatically increased by 150 mm in order to take account of the length of the extension for the Distance sensor.



**Figure F3.1.1 Application of the extension of Distance/Diameter sensor for measuring MOTO wheel type**

**Note:**

on machines without automatic sensor (or on machines where the automatic distance sensor is disabled), the distance data must be entered manually. To carry out this operation, you must: : a) place the tip of the extension of the Distance/Diameter sensor on the rim, b) read the distance value on the graduated scale, c) add 150 mm to the read value, d)

enter the distance value manually by pressing [P1]  and therefore [P4]  or [P5] .

Whenever the motorbike flange is removed (e.g. to balance wheels of auto-vehicles) and reassembled after, make sure the writings “Cal” present on the flange and on the flange for motorbikes are aligned. If this is not carried out, balancing accuracy may be compromised.

**3.2.3 SUV wheel type (off-road vehicles)**

The selection of the SUV Wheel Type allows the balancing of wheels of off-road vehicles. These vehicles are generally equipped with wheels that are larger than normal and the tyre is relatively large compared to the diameter of the rim (i.e. not low or super low type). Selecting this wheel type however does not allow the balancing of wheels for trucks because they have rims that are significantly different.

The choice of the CAR or SUV Wheel Type is at the discretion of the operator who should run balancing tests to determine which Wheel Type gives the best results for the particular wheel that is subject to balancing.



To select the SUV wheel type, press repeatedly [P6] until the SUV LED of the Wheel Type group LED lights up. See table T3.2.

All Programme Types listed in table T3.2 are available for the SUV Wheel Type. Weight positions along the section of the rim are the same as indicated in Figure F3.

**3.3 Entering wheel dimensions**

The dimensions of the wheel to balance can be entered in two ways:

- Manual Mode. This mode is always available.
- Automatic Mode. Only some models are equipped with sensors for the automatic entering (partial or total) of wheel dimensions.




**Note:**


all machines are equipped with graduated scales for manual measuring of the distance.

### 3.3.1 Manual entering of the wheel dimensions for the STD and ALU1,2,3,4,5 Programme Types




To introduce the wheel size manually, proceed as follows:


1. Assemble the wheel on the shaft;
2. Extract the distance sensor and place it on the wheel as shown in Figure F3.3.
3. Read the distance value on the graduated scale as shown in figure F3.3. The distance value is always expressed in millimetres;

4. Press [P1]  to modify the distance and then press [P4]  or [P5]  within 1.5 seconds to enter the read value. If you do not press buttons [P4] or [P5] within this time limit, the




machine will return to the previous display. In this case, you can press [P1]  again to enter or edit data;


5. Measure the width of the wheel with the special gauge or read the value of the width indicated on the rim. The value of the width can be in inches or millimetres according to the selected unit of measure.

6. Press [P2]  to modify the width and press [P4]  or [P5]  within 1.5 seconds to enter the read value. If either one of these two buttons is not pressed within in this time

frame, the machine will return to the previous screen. In this case, you can press [P2]  again to enter or edit data;

7. Read the value of the diameter indicated on the rim or tyre. The value of the diameter may be expressed in inches or millimetres according to the selected unit of measure.

8. Press [P3]  to modify the diameter value and then press [P4]  or [P5]  within 1.5 seconds to enter the read value. If either one of these two buttons is not pressed, in this time

frame, the machine will return to the previous screen. In this case, you can press [P3]  again to enter or edit data;

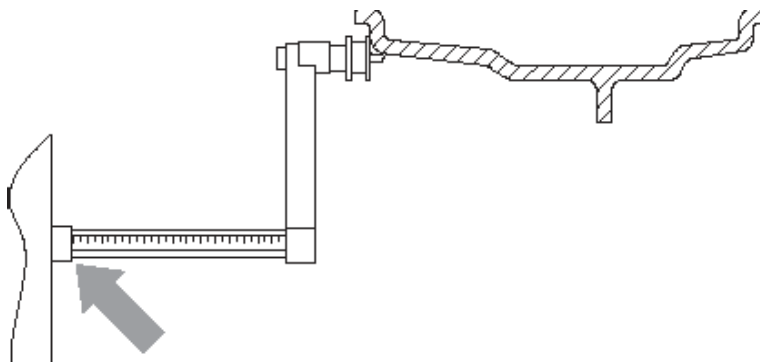


Figure F3.3 - Manual acquisition of wheel dimensions: placing the Distance sensor




---


---

### 3.3.2 Manual entering of the wheel dimensions for ALS1 and ALS2 Programme Types


To introduce the wheel size manually, proceed as follows:



1. Assemble the wheel on the shaft;
2. If the selected programme type is ALS1, extract the distance sensor and place it on the wheel as shown in Figure F3.4, otherwise proceed with step 4.
3. If the selected programme type is ALS2, extract the distance sensor and place it on the plane chosen for the internal weight as shown in Figure F3.4;
4. Read the value of the internal distance of the plane on the graduated scale. The distance value is always expressed in millimetres;


5. Press  once to view the **di1** parameter (distance of the internal plane), and press  or  within 1.5 seconds to enter the read value. If either one of these two buttons is not pressed, in this time frame, the machine will return to the previous screen. In this case,




you can press  again, twice in rapid sequence, to enter or edit data;

6. Extract the distance sensor and place it on the plane chosen for the external weight as shown in Figure F3.5;
7. Read the distance value on the graduated scale. The distance value is always expressed in millimetres;


8. Press  twice in rapid sequence until **di2** (distance of the external surface) is displayed


and, within 1.5 seconds, press  or  to enter the read value. If either one of these two buttons is not pressed, in this time frame, the machine will return to the previous screen.

In this case, you can press  again, twice in rapid sequence, to enter or edit data;

9. Press the button  once to view **da1** (diameter of the internal plane), and buttons  or  within 1.5 seconds to enter the value resulting from one of the two methods described in the note below.

If either one of these two buttons is not pressed, in this time frame, the machine will return to the

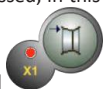
previous screen. In this case, you can press  again to enter or edit data;

10. Press the button  twice in rapid sequence to view **da2** (diameter of the external

plane), and buttons  or  within 1.5 seconds to enter the value resulting



from one of the two methods described in the note below. If either one of these two buttons is not pressed, in this time frame, the machine will return to the previous screen. In this case, you can press



[P1] again, twice in rapid sequence, to enter or edit data;

### Note:

The nominal diameter of the wheel does not match with the diameters where the weights are actually applied. There are two possible methods for determining the da1 and da2 diameters to be entered in steps 9) and 10).

#### METHOD 1: MANUAL MEASURING OF THE da1 AND da2 DIAMETERS

This method provides for a manual measuring of the da1 and da2 diameters or only the external da2 diameter (depending on the Programme Type enabled) with the aid of a ruler as shown in figure 3.3.1. The values to enter are indicated in table T3.2.1.

**Table T3.2.1 Measuring the da1 and da2 diameters for manual entering of the data**

Programme Type	Internal diameter da1	External diameter da2
ALS1	Enter the nominal diameter of the rim	Enter the actual diameter da2 measured with the aid of a measuring tape. The measurement must be performed on the balancing plane chosen for da2.
ALS2	Enter the actual diameter da1 measured with the aid of a measuring tape. The measurement must be performed on the balancing plane chosen for da1.	Enter the actual diameter da2 measured with the aid of a measuring tape. The measurement must be performed on the balancing plane chosen for da2.



**Figure F3.3.1 Example of manual measuring of the external diameter (da2) of the wheel in the ALS1/ALS2 Programme Type**

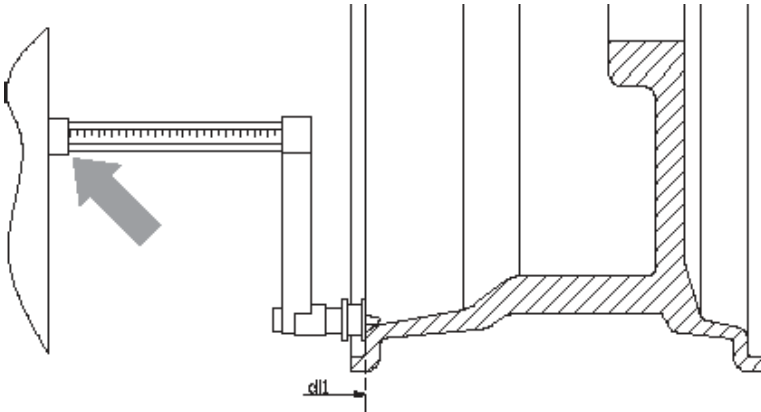
#### METHOD 2: ENTERING da1 and da2 STARTING FROM THE NOMINAL DIAMETER

This second method is used with the nominal diameter of the rim together with the corrections indicated in table T3.2.2.

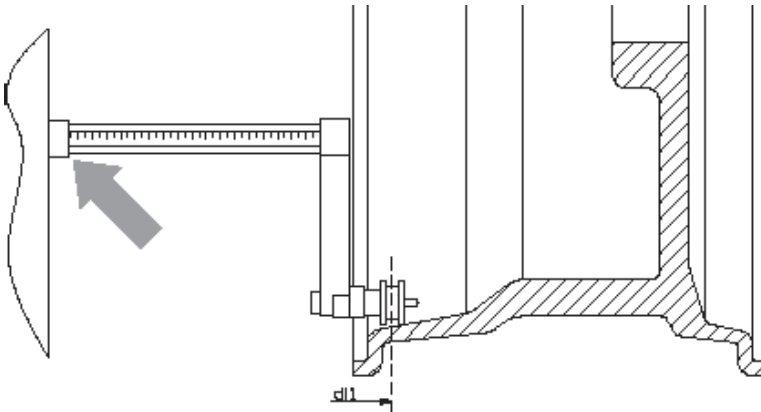
**Table T3.2.2 Determining diameters da1 and da2 starting from the nominal diameter of the rim**

Programme Type	Internal diameter da1	External diameter da2
ALS1	da1 = nominal rim diameter	da2 = nominal diameter - 2.0 inches (or 50 mm)
ALS2	da1 = nominal diameter - 1.0 inch (or 25 mm)	da2 = nominal diameter - 2.0 inches (or 50 mm)

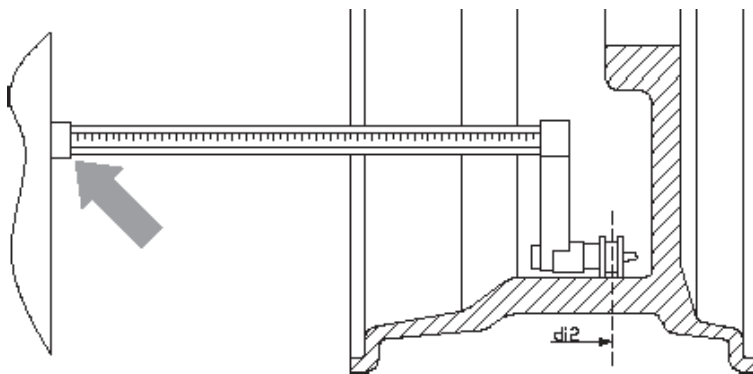
Since manual measuring is not required, this method is faster, but the results may be slightly less accurate.



**Figure F3.4 - Manual Acquisition of wheel distance in the ALS1 Programme Type**



**Figure F3.4 - Manual Acquisition of the internal plane distance in the ALS2 Programme Type**



**Figure F3.5- Manual Acquisition of the external plane distance in the ALS1 and ALS2 Programme Types**

---

---

### 3.3.3 Automatic acquisition of the wheel dimensions for the STD and ALU1,2,3,4,5 Programme Types

To introduce the wheel size automatically, proceed as follows:

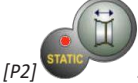
#### 3.3.3.1 Machines with Width sensor

1. Assemble the wheel on the shaft;
2. Extract both sensors and rest them on the rim as shown in Figure 3.6;
3. Wait to hear the long acquisition beep and then set the sensors back to the rest position. During acquisition, the distance and diameter values are shown on the display.

---

#### Note:

*the width is not displayed during automatic acquisition but to verify the newly acquired value, simply press*



It is possible to extract the Width sensor alone and view the width that refers to the last distance acquired (manually or automatically), but there will be no acquisition in this case. However, if you also extract the distance/diameter sensor, the display with the width will be removed and the acquisition as described in point 3 will start.

#### 3.3.3.1 Machines without the Width sensor

1. Assemble the wheel on the shaft;
2. Extract the Distance/Diameter sensor and place it on the rim as shown in Figure F3.6.
3. Wait to hear the long acquisition beep and then set the Distance/Diameter sensor back to the rest position;
4. Introduce rim width manually. The width of the rim is normally printed on the rim itself. Alternatively, use the appropriate width measuring gauge.

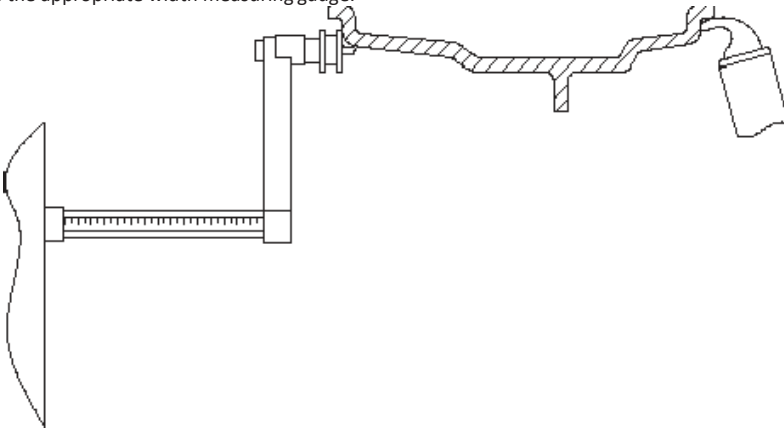



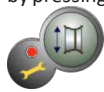
Figure F3.6 - Automatic data acquisition in the STD, ALU1,2,3,4,5 programmes

### 3.3.4 Automatic acquisition of the wheel dimensions for the ALS1 and ALS2 Programme Types

To automatically enter the dimensions of the wheel in the ALS1 and ALS2 Programme types, proceed as follows:

1. Assemble the wheel on the shaft;
2. Extract the Distance/Diameter sensor and place it on the plane chosen as the internal plane. The point of support differs depending on whether the ALS1 or ALS2 programme has been enabled. See figures F3.7 and F3.8;
3. Wait to hear the long acquisition beep and then extract Distance/Diameter sensor again (do not set the sensor back to the rest position) to place it on the plane chosen as the external plane;
4. Wait to hear the long acquisition beep and then set the sensor back to the rest position;
5. Now the program will enter the ALS2 type automatically. If need to use ALS1 type, adjust the program to ALS1 type manually after data measurement then use it.
6. The dimensions of the wheel have been acquired and the values can be displayed and/or modified

by pressing [P1]  for the  $d_{i1}$  /  $d_{i2}$  values (internal/external plane distance) and [P3]



for the  $d_{a1}$  /  $d_{a2}$  values (internal/external diameter plane).

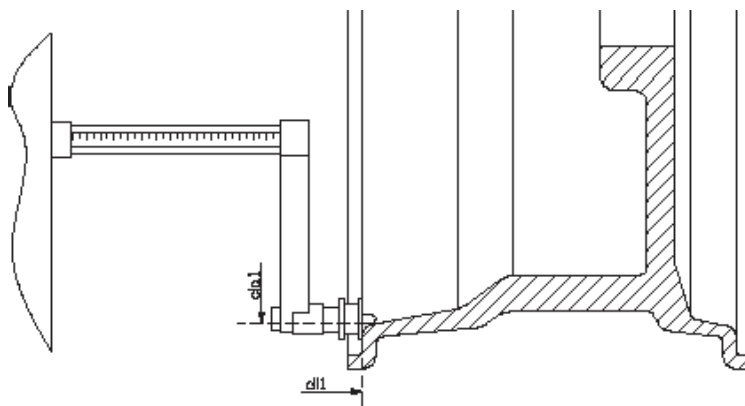


Figure F3.7 - Automatic acquisition of the internal plane distance in the ALS1 Programme Type

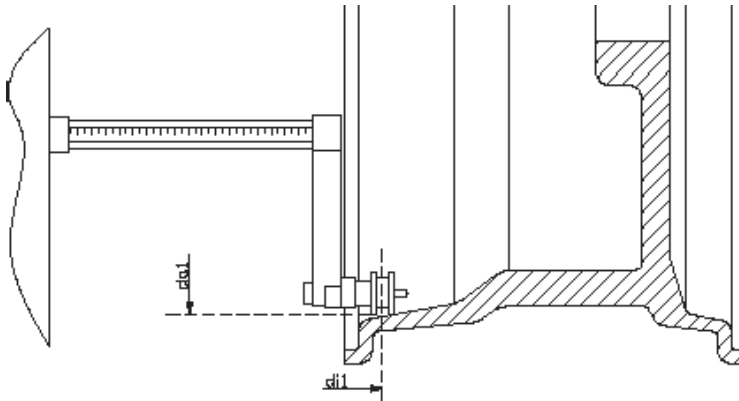


Figure F3.8 - Automatic acquisition of the internal plane distance in the ALS2 Programme Type

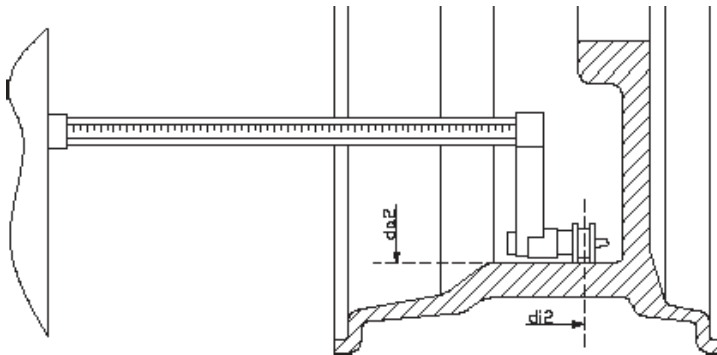


Figure F3.9 - Automatic acquisition of the external plane distance in the ALS1 and ALS2 Programme Type

### 3.3.5 Use of the Special Programme Types for ALS1 and ALS2 aluminium wheels

The machine features two Special Programme Types for aluminium wheels called ALS1 and ALS2. These two programmes are different from the normal Programme Types for aluminium wheels (from ALU1 to ALU5) because they allow the user to select the planes on which apply the balancing weights. This allows balancing aluminium wheels with special rim configurations where the use of conventional programmes for aluminium, which require precise weight positioning, would result difficult.

The difference between the ALS1 and ALS2 programmes lies in the fact that in the ALS1 Programme Type the user can freely choose only the external balancing plane (the internal plane is in a predetermined position) whilst, in the ALS2 Programme Type, the user can freely choose both balancing planes.

The ALS1 or ALS2 Programme Types use only the Distance/Diameter sensor to acquire the balancing planes chosen by the user. The Width sensor is not used.

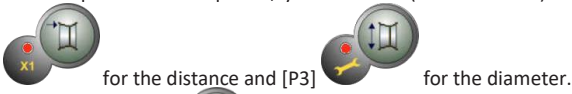
Use of the ALS1 or ALS2 Programme Types is divided into three parts:


- acquisition of balancing planes;
- balancing launch;
- search of the balancing planes for weight application.


#### 3.3.5.1 Acquisition of the balancing planes

The two balancing planes are acquired at this stage. During acquisition, the two pairs of distance and diameter values are stored. These pairs are called  $d_{i1}$  and  $d_{a1}$  (distance 1 and diameter 1) for the internal plane and  $d_{i2}$  and  $d_{a2}$  (distance 2 and diameter 2) for the external plane.




Once acquisition is completed, you can view (and even edit) these two pairs of values by pressing [P1]

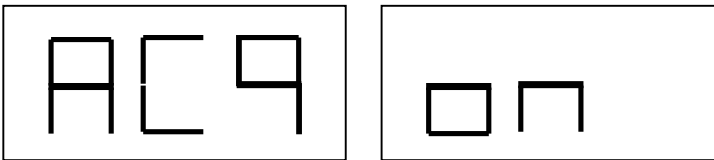


By pressing [P1] , the displaying of the distance values  $d_{i1}$  and  $d_{i2}$  are alternated. By

pressing [P3] , the displaying of the diameter values  $d_{a1}$  e  $d_{a2}$  are alternated.

To carry out acquisition, proceed as follows:

1. Select the ALS1 or ALS2 Programme Type by repeatedly pressing [P4]  or [P5]  ;
2. Select the plane balancing acquisition mode by pressing [P2]  until the writing ACq is viewed on the left display as shown in figure F3.10. When the machine is switched on, the acquisition mode is set by default ;



**Fig. F3.10 - "Balancing planes acquisition enabled" message**

3. Extract the Distance/Diameter sensor and place it on the rim that corresponds to the internal plane chosen to apply the balancing weight. See figure F3.7 for the ALS1 Programme Type and figure F3.8 for the ALS2 Programme Type;
4. Keep the sensor in the rest position until you hear the acquisition beep. If the sensor is left in the rest position for a longer time, further acquisition probing of that plane will be run without entailing consequences;
5. Set the Distance/Diameter sensor in the rest position immediately. If you hesitate with this operation, the machine may detect an incorrect plane: in this case, restore the sensor in rest position and repeat acquisition procedure;
6. Extract the Distance/Diameter sensor and place it on the rim corresponding to the external plane chosen to apply the balancing weight. See figure F3.9;
7. Keep the sensor in the rest position until you hear the acquisition beep. If the sensor is left in the rest position for a longer time, further acquisition probing of that plane will be run without entailing consequences;
8. Set the Distance/Diameter sensor in the rest position immediately. If you hesitate with this operation, the machine may detect an incorrect plane: in this case, restore the sensor in the rest position and repeat acquisition procedure;

### 3.3.5.2 Balancing launch

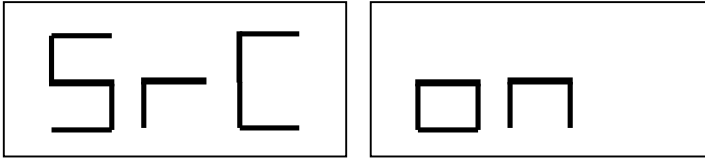


Press [P8] Start or lower the wheel guard to run a balancing launch. Once the launch cycle is completed, the imbalance values calculated according to the balancing planes chosen will be displayed.

### 3.3.5.3 Search of the balancing planes

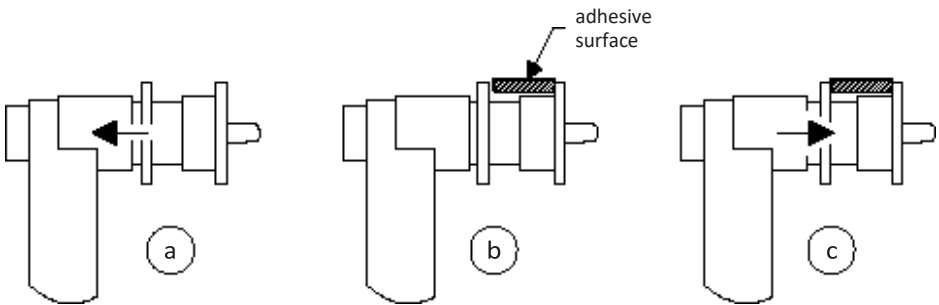
The purpose of the balancing planes search is to find the planes previously chosen by the operator in order to apply the balancing weights. Proceed as follows:

1. The machine enters SrC 0 mode automatically when stop rotation. The left window shows SrC like F3.11. The window will show the unbalance value of ralted position after short break.



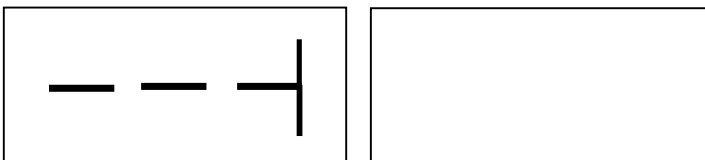
**Fig. F3.11 - "Balancing planes search enabled" message**

2. Apply the weight shown on the left display (internal weight) on the Distance/Diameter sensor as seen in figure F3.12;

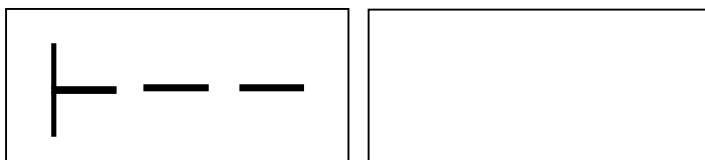


**Fig. F3.12 Application of adhesive weights on the Distance/Diameter**

3. Manually rotate the wheel until all the internal imbalance position LEDs light up (see fig. F1, detail [4]). Block the wheel in this position by using the footbrake or electromagnetic brake (if present);
4. Slowly extract the sensor until you hear the continuous beep indicating that the internal balancing plane has been reached. The left display helps the operator in this operation by indicating the direction in which the sensor must be moved. See figures F3.13, F3.14 and F3.15;



**Fig. F3.13 - Balancing planes search: the left display indicates to extract the sensor (moving it to the right) in order to find the exact position of the internal balancing plane**



**Fig. F3.14 - Balancing planes search: the left display indicates to re-introduce the sensor (moving it**



to the left) in order to find the exact position of the internal balancing plane

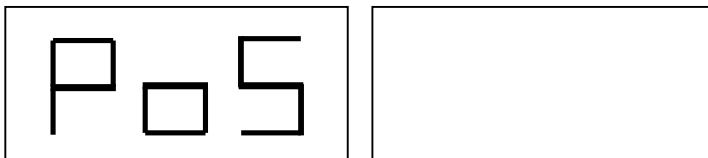


Fig. F3.15 - Balancing planes search: the left display indicates that the sensor is exactly on the internal balancing plane

5. Keep the Distance/Diameter sensor blocked at this distance, then, rotate it until the adhesive weight sticks on the rim. The sensor's contact point on the rim will assume an intermediate position between 12 o'clock and 6 o'clock depending on the diameter of the rim. See also table T3.3;
6. Bring the Distance/Diameter sensor back in the rest position. The indications on the left and right display will be exchanged to indicate the search for the external balancing plane;
7. Release the wheel and repeat steps 2 to 6 for the external weight;
8. Run a balancing test launch.

If the balancing of an identical wheel must be performed, you can skip the balancing plane acquisition phase and carry on directly with the balancing launch and, subsequently, with the search of the balancing planes. The balancing planes used for calculation will be those previously stored.

**Note:**

*if you set the Static imbalance display, the sole balancing weight must always be applied in the 6 o'clock position at any point along the section of the rim. The balancing planes search phase described in chapter 3.3.5.1 should therefore not be run.*

**3.3.6 Use of the ALS1 or ALS2 Programme Types without automatic acquisition**

When a machine is not equipped with the automatic acquisition system by means of the Distance/Diameter sensor, or when the sensor itself has been disabled, you can still use the special ALS1 or ALS2 programmes. Since it is not possible to acquire the two planes automatically by means of the Distance/Diameter sensor, you must manually enter the values of the two pairs of dimensions  $d_{i1}/d_{a1}$  and  $d_{i2}/d_{a2}$  as shown in chapter 3.3.2 *Manual entering of the wheel dimensions for the ALS1, ALS2 Programme Types.*

After the launch, the angular position of the balancing weights are given in table T3.3.

**Table T3.3 Angular position of the balancing weights in the ALS1 and ALS2 Program Types without automatic acquisition system**

Programme Type	Internal Plane	External Plane	Static Plane
ALS1	H12	H6	H6
ALS2	H6	H6	H6

**3.3.7 Use of the ALS1 or ALS2 Programme Types without preliminary acquisition of the balancing planes**

It is possible to run a launch when any Programme Type, other than ALS1 or ALS2, is enabled and then selecting the ALS1 or ALS2 Programme Type. The machine will recalculate the imbalance data according to the new Programme Type selected.

In this case, however, the imbalance values displayed are obtained by using the balancing planes (i.e. the two  $d_{i1}/d_{a1}$  and  $d_{i2}/d_{a2}$  dimension pairs previously acquired or, lacking these, the default balancing planes.

## 4. MACHINE CALIBRATION

To operate the machine properly, it must be calibrated. Calibration allows storing the mechanical and electrical parameters specific to each machine so as to provide the best balancing results.

### 4.1 When to carry out machine calibration

Table T4 lists the cases in which machine calibration should be carried out. Calibration must be carried out whenever one or more of the conditions listed are active.

**Table T4 - Conditions for machine calibration**

Condition	Status	Who must perform it
When the machine is installed at the site of the end customer	Compulsory	Technical Support
When the CPU-C1 electronic circuit board is replaced	Compulsory	Technical Support
When a mechanical part linked to the pick-up signals (pick-up, pick-up compression springs, suspension unit + shaft) is replaced	Compulsory	Technical Support
When calibration of the pick-up pre-tensioning springs has been altered	Compulsory	Technical Support
When the encoder disc is replaced	Compulsory	Technical Support
When you use a flange for motorbikes different from that used in the previous calibration for MOTO Wheel Type	Compulsory	Final user and/or Technical Support
When the machine does not provide optimal balancing results	Recommended	Final user and/or Technical Support
When there are consistent and constant variations in temperature and humidity (e.g. in seasonal changes)	Recommended	Final user and/or Technical Support

The machine requires two independent calibrations:

- Calibration for the CAR/SUV Wheel Type (calibration is the same for both types of wheels);
- Balancing for the MOTO Wheel Type (wheels for motorbikes).

It is not compulsory to run both calibrations. If, for example, a user uses the machine exclusively for motorbike wheel balancing, he must perform calibration only for the MOTO Wheel Type. Similarly, if the user uses the machine exclusively to balance auto-vehicle/off-road wheels (CAR/SUV), he must run calibration only for the CAR/SUV Wheel Type.

If the user instead uses the machine to balance all Wheel Types, he must run both calibrations. It does not matter the order in which the two calibrations are performed.

### 4.2 Calibration according to the CAR/SUV Wheel Type

The calibration for the CAR and SUV Wheel Types is the same.


To perform machine calibration, you must first provide for the following material:



- a balanced wheel with steel rim that has the following dimensions: Diameter 15" Width 6". The distance of the wheel from the machine should be approximately 100 mm. You can also use wheels with dimensions similar to those recommended as long as the difference is minor. It is not possible to use wheels with rims in aluminium;
- A 50 gram weight (preferably in iron or zinc).

---

To run the machine calibration, proceed as follows:

1. Start-up the machine;
2. Remove the wheel and any other accessories from the shaft;
3. Press [F+P3]. The writing SER SER will be displayed (this means that we have entered the SERVICE mode) (service programme);

4. Press  . The writing CAL CAR (machine calibration for auto-vehicle and light off-road vehicle wheels);


5. With buttons  or  , select the CAR (auto-vehicle and light off-road wheels) or MOT (motorbike wheels) calibration type.


---






**Note:**


*the calibration for motorbike wheels is described separately in chapter 4.3 Machine calibration for MOTOWheel Type.*

---


6. Press  . The writing CAL 0 will be displayed;

7. Press  Start or lower the wheel guard. The machine will run a launch and will show the writing CAL 1 on the display once completed;

8. Mount the wheel on the shaft and enter its dimensions by pressing the keys  ,  ,  to select the dimensions to edit and keys  or  to edit the value. If the dimensions of the wheel were introduced before entering the calibration programme, this step can be skipped. It is not possible to enter the data with the automatic acquisition system;


9. Press  Start or lower the wheel guard: the machine will run a launch;

10. Once the launch is completed, manually rotate the wheel until value 50 is seen on the left display. Apply the 50 g weight at the 12 o'clock position on the internal side of the wheel.


11. Press the button  Start or lower the wheel guard: the machine will run a launch;

12. Remove the 50 g weight applied on the internal side.

13. Manually rotate the wheel until the value 50 is seen on the right display. Apply the 50 g weight at the 12 o'clock position on the external side of the wheel.



14. Press the button  Start or lower the wheel guard: the machine will run a launch.

15. If the machine is not equipped with electromagnetic clamping brake, or if this has not been enabled, the machine switches directly to the next step. If, instead, the machine is equipped with electromagnetic clamping brake, and if this function has been enabled, once the previous launch is completed, the machine will run a further series of short launches to calibrate the wheel stop function on the imbalance position (see chapter 8.5 SWI Wheel stop procedure on the positions of imbalance). Do not



raise the wheel guard or press  Stop during this phase.



16. Calibration is completed: the machine automatically exits the calibration programme and returns to the NORMAL mode, ready to perform the balancing.

If during machine calibration there are some anomalies, error codes will be displayed (e.g. Err 025). See chapter 6.1 *Error Codes* and act accordingly to eliminate the problem and to continue/repeat/cancel the calibration in progress.

The launches interrupted by pressing [P10] Stop  or by raising the wheel guard may be repeated by pressing [P8] Start  or by lowering the wheel guard.

### 4.2.1 How to exit the CAR/SUV Wheel Type calibration

You can exit the ongoing calibration procedure at any time by pressing [F + P3]  + . The machine will return to the SERVICE mode displaying the writing SER SER. To return to the NORMALE mode,

press [F+P3]  +  again.

The calibration procedure in progress will be cancelled and the balancing results will use previous calibration values.

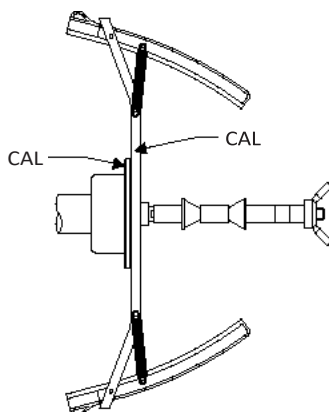
### 4.3 Calibration according to the MOTO Wheel Type

Calibration for the MOTO Wheel Type (wheels for motorbikes) is completely separated from the machine calibration for the CAR/SUV Wheel Type because it takes into account the fact that the machine uses a special flange for motorcycle wheels that slightly alters the balancing of the shaft.







If MOTO Wheel Type calibration has not been carried out and you try to run a balancing launch when the MOTO Wheel Type is selected, the machine will not run the launch and will display the error code E R R 03 1 .

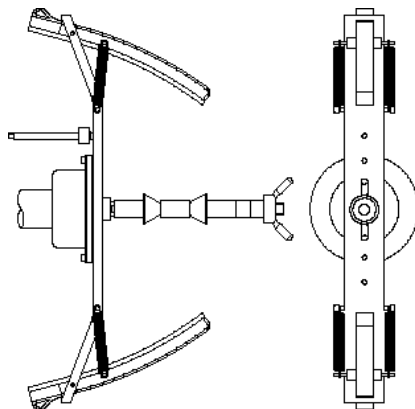
To calibrate motorbike wheels, proceed as follows:

1. Switch the machine on;
2. Apply the flange on the shaft for motorbike wheels as shown in Figure F4.1.



**Fig. F4.1 Application of the motorbike flange onto the shaft. Align the writing "Cal" on the flange and on the flange for motorbikes**

3. Press [F+P3]  + . You have entered the SERVICE mode.
4. Press [P3] . The vehicle (motorcycle and off-road vehicle wheels) will be displayed;
5. To select the MOTO (motorcycle) calibration type, press the MOTO calibration type motorbike flange and auto mode key .
6. Press [P3]  to confirm the selection.
7. Press [P8]  Start or lower the wheel guard: the machine will run a launch;
8. At the end of the launch, the machine will display the writing h 1 2 C A L . Apply the calibration weight on the internal side as shown in Figure F4.2. The calibration weight is to be applied on the hole that has the writing "CAL" marked on it;



**Fig.F4.2Application of sample weight on the internal side of the motorcycle flange on the shaft (Cal2 phase)**

9. Bring the motorcycle flange in perfect vertical position with the calibration weight at the top part as shown in figure F4.2 and press the [P8]  Start or lower the wheel guard.

Note: If the position is significantly different from the vertical one, the machine will reject running the launch by emitting an acoustic error message (triple beep).


If the flange for motorbikes is close enough to the vertical position but not perfectly vertical, the machine will run the launch but at the end of the calibration procedure, all balancing launches will present an error indicating the angular position of the balancing weights;

10. At the end of the launch, the machine will display the writing C A L h 1 2 . Apply the calibration

weight on the external side as shown in Figure F4.3. The calibration weight is to be applied on the hole that has the wording "CAL" marked on it;

**Fig. F4.3 Application of the sample weight on the external side of the flange for motorbikes on the shaft (Cal3 phase)**

11. Bring the flange for motorbikes in perfect vertical position with the calibration weight at the top


part as shown in figure F4.3 and press the  [P8] Start or lower the wheel guard. If the position is significantly different from the vertical one, the machine will reject running the launch by emitting an acoustic error message (triplebeep).

12. Once the calibration launch for the MOTO Wheel Type is completed, the machine returns directly to the NORMAL mode, ready to perform the balancing.



When the machine completes calibrating, the MOTO Wheel Type and the ALU1 Programme Type will remain set. Even the dimensions of the wheel will remain those set automatically by the machine for this type of calibration.



If there are some anomalies during machine calibration, error codes will be displayed (e.g. `E r r 02 5` ). See chapter 10.1 (Error Codes) and act accordingly to eliminate the problem and to continue/ repeat/cancel the calibration in progress.

The launches interrupted by pressing  [P10] Stop or by raising the wheel guard may be repeated by

pressing  [P8] Start or by lowering the wheel guard.

#### 4.3.1 How to exit from auto-vehicle calibration mode for the MOTO Wheel Type You

can exit the ongoing calibration procedure at any time by pressing  +  . The machine will return to the SERVICE mode displaying the writing `S E R S E R` . To return to the NORMAL mode, press

 +  [F+P3] again.

The calibration in progress will be cancelled and the balancing results will use the calibration results for







the MOTO Wheel Type previously used. Even in this case, the MOTO Wheel Type and the ALU1 Programme Type will remain set and the dimensions of the wheel will remain those set automatically by the machine for this type of calibration.

## 5. OPTIMISATION

The optimisation programme is used to minimise the amount of balancing weights to be applied on the rim by opposing the imbalance of the rim to that of the tyre.

Therefore, use this programme when the wheel requires the application of heavy balancing weights.

To access the optimisation programme, proceed as follows:

1. Press [F+P4]  + . The display will show the options shown in figure F5.1. Press [P4]  or [P5]  and choose the option `Opt-1-` to continue, or the option `Opt ret` to return to the operating programme. Press [F+P4]  +  to confirm the chosen option;

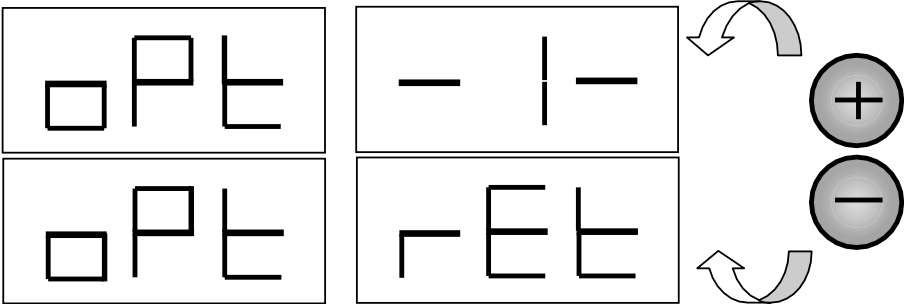



Fig. F5.1 Access to the Optimisation programme

**Note:**

you can exit the calibration procedure at any time by repeatedly pressing [F+P4]  + .

2. If the wheel's static imbalance is less than 12 grams, the machine will display the message shown in Figure F5.2 for a second and then will automatically exit the optimisation programme. If the wheel's static imbalance is instead greater than or equal to 12 grams, the message shown in Figure F5.3 will be displayed;

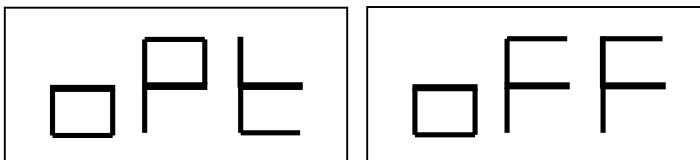


Fig. F5.2 Optimisation Programme not possible



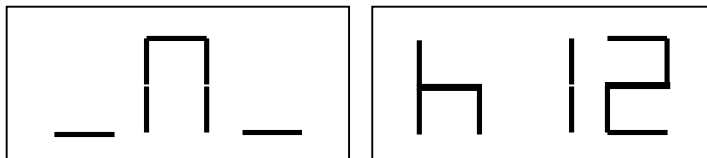


Fig. F5.3 - "Bring the valve to the 12 o'clock position" message

3. Bring the valve to the 12 o'clock position, mark the valve position on the tyre (see figure F5.4);

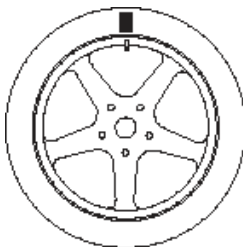



Fig. F5.4 - Marking of the valve position on the tyre

4. Press [P4] . The message seen in figure F5.5 will be displayed;

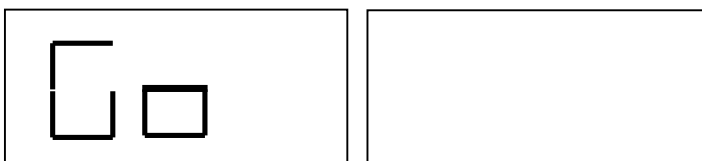


Fig. F5.5 "Run the launch" message

5. Remove the wheel from the shaft, remove the tyre bead, rotate it so that the mark is at 180° respect to the valve (see figure F5.6);

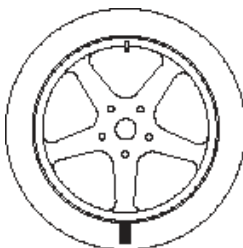



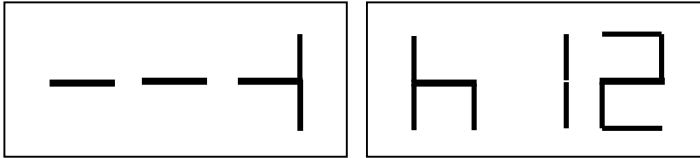


Fig. F5.6 - Marking the tyre at 180° respect to the valve

6. Remount the wheel on the shaft, erase the mark and run a launch;
7. At the end of the cycle, the message seen in figure F5.3 will be displayed. Two options are available:

- a) Bring the valve to the 12 o'clock position and press [P4]  to continue. In this case, the message seen in figure F5.7 will be displayed.

- b) Press **[F+P4]**  +  to exit the optimisation programme and to directly return to the operating programme;



**Fig. F5.7** “Final valve alignment with the mark on the tyre” message

8. Rotate the wheel until all position arrow LEDs light up and then mark the 12 o'clock position as shown in figure F5.4;
9. Remove the wheel from the balancing machine, remove the bead from the tyre and rotate it until the valve matches the mark on the tyre;

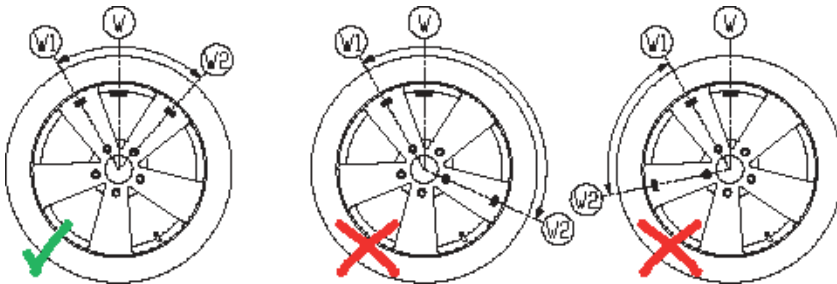


10. Optimisation is completed: exit the optimisation menu by pressing **[F+P4]**
11. Remount the wheel on the balancing machine and balance it with the normal procedure.

## 6. HIDDEN WEIGHTS PROGRAMME

This programme divides the external weight  $W$  in two weights  $W1$  and  $W2$  (smaller than the initial external weight  $W$ ) located in any two positions selected by the operator.

The two weights  $W1$  and  $W2$  must form a maximum angle of  $120^\circ$  including the external weight  $W$ , as shown in Figure F6.1.



**VALID**  
The angle between weights  $W1$  and  $W2$  is  $< 120^\circ$  and includes the initial external weight  $W$ .

**NOT VALID!**  
The angle between the weights  $W1$  and  $W2$  is  $\geq 120^\circ$

**NOT VALID!**  
External imbalance  $W$  not between  $W1$  and  $W2$

**Fig. F6.1 - Hidden Weights Programme: valid and invalid conditions for use**

The Hidden Weights programme is used for aluminium rims when:

- you want to hide the external weight behind two spokes for aesthetic reasons;
- the position of the external weight coincides with a spoke therefore a single weight cannot be applied.

**Note:**

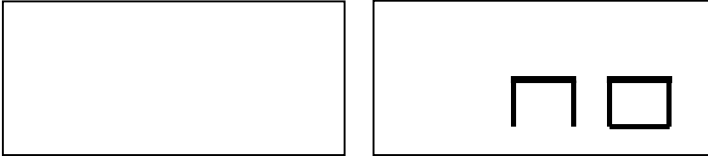
This programme can be used with any Programme Type and with any Wheel Type. It can also be used to divide the static weight into two separate weights (especially useful with wheels for motorbikes).

To use this programme, proceed as follows:

1. Perform the balancing of the wheel without applying the external weight;

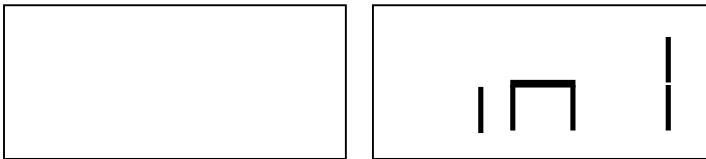


2. Press [F+P5] to run the Hidden Weights programme. If the wheel is balanced on the external side, the machine will display the message shown in figure F.6.2 for about 1 second on the right display and a triple beep will indicate that the operation is not allowed.



**Fig. F6.2 Hidden Weight Programme not possible or chosen position not allowed**

3. If there is an imbalance on the external side instead, the machine will display the message shown in the figure. F6.3.



**Fig. F6.3 Input of the weight W1 position**

**Note:**

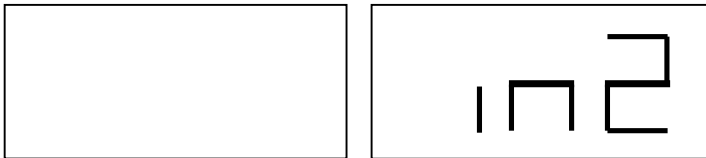
You can exit the "hidden weights" programme at any time by pressing [F+P5].

4. Rotate the wheel manually until all external imbalance search LEDs light up (see detail [9] of figure F1).
5. Rotate the wheel manually until the point where you want to apply the external weight W1 is reached




and press [P1] to confirm. The angle formed by W1 and by the initial external weight W must be less than 120°.

6. If the angle is greater than 120°, the machine will display the message shown in figure F6.2 for one second and will emit a triple beep indicating that another point must be chosen. If the angle instead is less than 120°, the machine will display the message shown in Fig. F6.4, allowing you to continue with the next step.

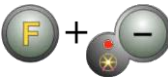


**Fig. F6.4 Input of the weight W2 position**

7. Rotate the wheel manually until the point where you want to apply the external weight W2 is reached

and press [P1]  to confirm. The angle formed by the weights W1 and W2 must not be less than 120° and must include the external weight W.

8. If the chosen angle is greater than 120°, the machine will display Fig. F6.2 for one second and will emit a triple beep meaning to repeat the procedure in step 7 again. If the angle instead is less than 120°, the machine will immediately display the value of the external weight W2.
9. Block the wheel and apply the external balancing weight W2 as indicated on the display. Consult table T3.1.1 for the exact application point of the external weight.
10. Manually rotate the wheel until external weight value W1 does not appear on the left display.
11. Block the wheel and apply the external balancing weight W1 as indicated on the display. Consult table T3.1.1 for the exact application point of the external weight.

12. The Hidden Weights programme procedure is completed: press [F+P5]  to exit and run a balancing test launch.

**Note:**

figure F6.1 indicates the position of the external weight at the 12 o'clock position but this is valid only for certain Programme Types. Table T3.1.1 shows the actual position of the external imbalance based on the Programme Type and on the enabling state of the Distance/Diameter sensor.

## 7. SECOND OPERATOR

The machine has two separate memories allowing two operators to work simultaneously with different settings.

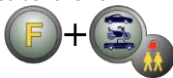
This feature can make operations at the workshop quicker because when, for example, an operator is busy with removing or remounting a tyre, the other operator can use the machine to perform balancing operations and vice versa.

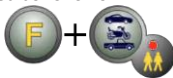
In this manual, the two operators are defined as *operator 1* and *operator 2*.

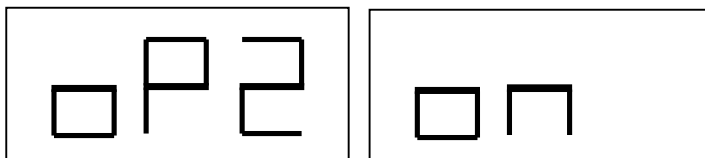
When operator 1 has completed his tasks on the machine or is involved in other activities, operator 2 can work with the machine using the settings for the wheel type he is working on without altering the settings entered by operator 1.

When the machine is switched on, the two memories are set with the same values by default.

To use this function, operator 2 must proceed as follows:

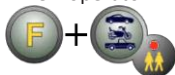


1. When the machine is free, press [F+P6]  to select operator 2. The LED located next to the button lights on to indicate that operator 2 is enabled. The message shown in figure F7.1 will be displayed for one second.

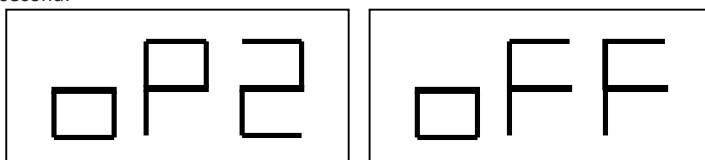


**Fig. F7.1 Enabling the memory of operator 2. The memory of operator 1 is stored.**

2. Perform all desired settings for wheel dimensions, Programme Type, Wheel Type and unit of measure. The settings of operator 1 are stored in memory.
3. Perform balancing of the wheel or wheels.
4. When operator 2 has finished his task on the balancing machine, operator 1 presses [F + P6]

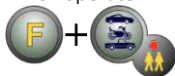


and thus restores all settings used by the latter. The LED located next to the button will turn off to indicate that operator 1 is enabled. The message shown in figure F7.2 will be displayed for one second.



**Fig. F7.2 Disabling the memory of operator 2. The memory of operator 1 is restored.**

5. When operator 1 has completed his tasks on the balancing machine, the operator can press [F + P6]



again to restore the wheel settings entered by him in step 2.

6. Tasks can continue, alternating the two operators.

An operator can change the following settings without editing the settings entered by other operators:

- Wheel dimensions (distance, width, diameter);
- Programme Type (STD, ALU1, ALU2, ALU3, ALU4, ALU5, ALS1, ALS2);
- Wheel type (CAR, MOTO, SUV);
- Unit of weight (grams or ounces);
- Unit of measure of the wheel dimensions (millimetres or inches);

**Note:**

*the settings for the wheel's units of weight and dimension entered by operator 2 are not stored in the machine's permanent memory and therefore will remain active only until the machine is switched off.*

## 8. UTILITY PROGRAMMES

Utility programmes are available only in NORMAL mode.

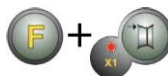
### 8.1 Selecting the imbalance display resolution

The machine has two wheel imbalance display resolutions. The two resolutions are defined as X1 (high resolution) and X5 (low resolution).

The resolution with which the imbalances of the wheel are displayed varies depending on the unit of weight as indicated in table T8.1.

**Table T8.1 Display resolution**

Set resolution	Imbalance unit of measure	Display resolution	Notes
X1 (high resolution)	Grams	1 gram	
	Ounces	0.1 ounces	
X5 (low resolution)	Grams	5 grams	The X5 resolution is set by default at start-up
	Ounces	0.25 ounces	



To view the imbalance in X1 resolution (high resolution) press [F+P1]. The machine will display the message visible in Figure F8.1.0a for one second and the LED next to the button will turn on. Imbalance values are now displayed in X1 resolution (high resolution).

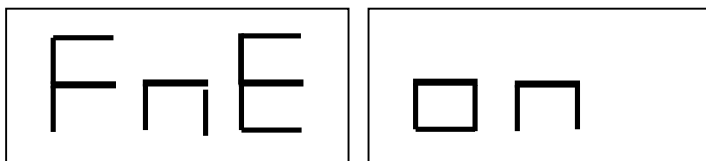


Fig. F8.0a Enabling of the imbalance display in high resolution.



To return to viewing in X5 resolution (low resolution) press [F+P1] again. The machine will display the message visible in Figure F8.0b for one second and the LED next to the button will turn off. Imbalance values are now displayed in X5 resolution (low resolution).

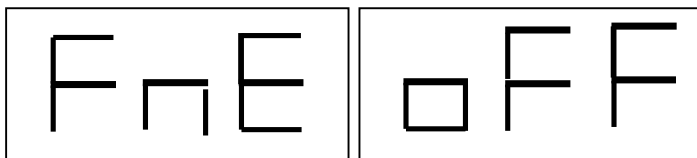
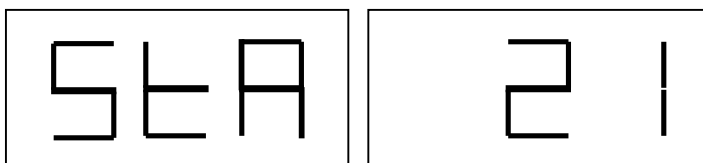


Fig. F8.0b Disabling imbalance view in high resolution.

## 8.2 Selection of the static imbalance display



To view the static imbalance, press [F+P2]. The machine will show the static imbalance value on the display as seen in figure F8.1 and the LED next to the button lights up.



**Fig. F8.1** View of the Static imbalance display enabled. The right display indicates the entity of the static imbalance.



To return to the dynamic imbalance display, press [F+P2] again. The LED next to the button will turn off.

### Note:

*in some cases, static imbalance is forcibly set by the machine according to the current settings. For example, if the MOTO Wheel Type programme is enabled and the width set is less than 4.5 inches, the machine will automatically set the static imbalance display.*

## 8.3 Electromagnetic clamping brake (available only on some machine models)

The electromagnetic clamping brake is useful to block the wheel in any position defined by the user and to simplify some operations such as the application or removal of balancing weights.

If present, the electromagnetic clamping brake is also used in the automatic or manual stopping of the wheel on imbalance positions described in chapter 8.5 *SWI Wheel stop procedure on the positions of imbalance*.



To activate the electromagnetic clamping brake, press [P9]. To deactivate the electromagnetic

clamping brake, press [P9] again.

The electromagnetic clamping brake is deactivated automatically in the following cases:

- Every time a balancing launch is run;
- Every time a SWI procedure is performed (stop of the wheel on the imbalance positions) at low speed;
- After one minute of continuous activation (to avoid overheating of the brake itself).







The electromagnetic clamping brake can be used manually only in NORMAL mode. It cannot be used in the SERVICE mode.



If the electromagnetic clamping brake is equipped on the machine but disabled, by pressing [P9] a triple beep is emitted indicating this condition. To enable the electromagnetic clamping brake, contact technical support.

## 8.4 Illuminator (only in some machine models)

The illuminator is quite useful because it allows shedding light on the internal part of the rim which is normally barely visible, thus making balancing operations easier.

To turn on the illuminator, press  +  + . To turn off the illuminator, press  +  +  again.

The illuminator is also automatically managed by the machine that turns it on in the following cases:


- When the Distance/Diameter sensor is extracted;
- After a wheel stop procedure on the position of imbalance (SWI procedure) which resulted in the balancing position of the internal weight;
- When the wheel itself is in the balancing position of the internal weight by manually rotating the wheel after a launch;

### 8.5 SWI wheel stop procedure on the positions of imbalance

Machines equipped with the electromagnetic clamping brake are capable of automatically stopping the wheel at the first imbalance angular position that is reached during rotation. This allows the operator to have the wheel in position ready for the application of the balancing weight thus increasing work and productivity speeds.

The procedure is referred to with the short English acronym SWI (Stop the Wheel on Imbalance). Within this manual, this acronym will be used to refer to the wheel stop procedure on the positions of imbalance. The SWI procedure has three different operating modes indicated in table T8.2.

**Table T8.2 Types of SWI procedures available.**

SWI mode	When it is or when it can be run	Who can run the SWI procedure?	Notes
Automatic	At the end of every launch	Machine	This is performed only if there is at least one imbalance value on the wheel. Otherwise, conventional braking will occur.
Low speed	At the end of the launch, when the wheel is stationary and the wheel guard is raised	Operator	Procedure started by pressing [P8]  Start: the wheel starts spinning at low speed until the first angular position of imbalance is reached.
Manual	At the end of the launch by manually rotating the wheel with wheel guard raised	Operator	At each passage of the wheel in an angular position of imbalance, the electromagnetic clamping brake will be enabled for 30 seconds.

The three SWI modes have functions that are slightly different one from the other although, in all modes, the ultimate goal is to block the wheel at an angular position of imbalance and make operators' tasks quicker.

#### 8.5.1 Automatic SWI procedure

During the automatic SWI procedure, the machine will measure rotational speed during braking at completion of the launch and, when this reaches a predetermined value, it will release the brake allowing the wheel to spin freely by inertia. When the speed is low enough, the machine will wait until the wheel passes through one of the angular positions of imbalance, therefore, it will enable the electromagnetic clamping brake.

**Note:**

*for operator safety purposes, the SWI procedure will not be run when the MOTO Wheel Type is enabled.*



## 8.5.2 SWI procedure at low speed

In the low speed SWI procedure, the wheel has already run the launch and is stationary. If the operator



presses [P8] Start with the wheel guard raised, the machine will apply slight acceleration to the wheel and then let the same spin by inertia. When the speed is low enough, the machine will wait until the wheel passes through one of the angular positions of imbalance, therefore, it will enable the electromagnetic clamping brake.

### Note:

for operator safety purposes, the SWI procedure will not be run when the MOTO Wheel Type is enabled.

## 8.5.3 Manual SWI procedure

In this mode, the SWI procedure is activated by manual rotation of the wheel if the wheel crankcase guard is raised. When the wheel passes through an angular position of imbalance, the machine will enable the electromagnetic clamping brake.

Angular positioning accuracy depends on many factors. Among the most important, they are: wheel dimensions and weight, adjustment of the electromagnetic brake, temperature, belt tension.

In all cases, consider the following:

- If the electromagnetic clamping brake is disabled, the SWI procedure will not be run in any of three modes;
- In the automatic SWI procedure, the wheel must be heavy and large enough to provide the inertia required for the running of this procedure. In case of particularly light and/or small wheels, the machine might not run the SWI procedure and will use conventional braking;
- If rotation speed decreases abruptly due to wheel inertia during the automatic SWI procedure or the low speed SWI (e.g. due to excessive friction with rotating mechanical parts), the machine applies a little extra acceleration to the wheel itself in order to reach the first angular position of imbalance. If, despite this, the wheel does not reach this position, the SWI procedure is aborted after 5 seconds and a triple beep will signal this condition;
- When you use the manual SWI procedure, balancing precision will also depend on the speed with which the operator rotates the wheel: excessively high or low speeds reduce accuracy.

## 9. SERVICE MODE

In this mode, the machine allows the user to enter certain settings (for example, selection of the units of measure) or use special testing programmes (to verify machine functioning) or configuration.

Some test and configuration programmes are included in this Menu while the setting programmes are available with direct access by means of the buttons. See table T9 to consult the full list of settings, programmes and menus available in the SERVICE mode.

### Note:

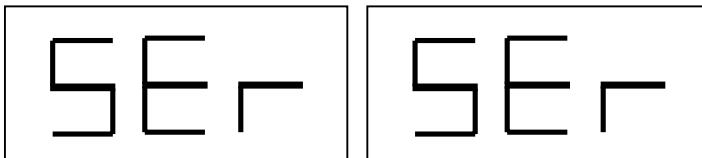
some test or configuration programmes are not available to the end user but only to technical support personnel.

To access the SERVICE mode, proceed as follows:

1. Switch the machine on and wait for completion of the initial test. After running the initial test, the machine will be in the NORMAL mode;

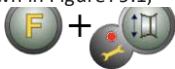


2. Press [F+P3]. The machine enters the SERVICE mode and will display the Ser Ser messages. See figure F9.1.



**Fig. F9.1 SERVICE mode enabled**

- To exit the SERVICE mode, you must first exit any Menus and test programs and return to the messages display shown in Figure F9.1;






- Press [F+P3] : the machine will return to the NORMAL mode.

### 9.1 [P1] MENU Sensor calibration programmes

This menu allows running the test and/or calibration of the sensors for measuring Distance, Diameter and Width. The Menu has the following options:

- **D**i**S** Distance sensor test;
- **L**a**r** Test and/or calibration of the Width sensor;
- **D**i**A** Test and/or calibration of the Diameter sensor;
- **R**e**t** Returns to the Service mode.

To scroll through the different menu options, press [P4]  or [P5]  until the desired

option is viewed, then press [P1]  to confirm the selection.

#### **Note:**

*sensor calibration programmes are mainly reserved for technical support personnel but may also be run by end users as it does not impair machine operation.*

#### **D**i**S** Distance sensor test

This programme allows checking the correct functioning of the automatic acquisition of the wheel's distance. There are no calibrations to carry out to the automatic acquisition system of the distance.

#### **L**a**r** Test and/or calibration of the Width sensor

This programme allows checking the correct functioning of the automatic acquisition of the wheel's width. The automatic wheel width acquisition system requires calibration.

#### **D**i**a** Test and/or calibration of the Diameter sensor

This programme allows checking the correct functioning of the automatic acquisition of the wheel's diameter. The automatic wheel diameter acquisition system requires calibration.

#### **R**e**t** Returns to the Service mode

This Test Programme menu option sets the machine back in the SERVICE mode

## 9.2 [P2] Not used

This button is not currently used in Service mode.

### 9.3 [P3] Machine calibration

This button allows accessing the machine's calibration procedure as described in detail in chapter 4 *Machine calibration*.

### 9.4 [P4] Select grams/ounces

By pressing this button, the machine alternates the unit of measure of the wheel weight: if the unit of measure selected is in grams, select ounces and vice versa. This selection is maintained even when the machine is shut-down.

The unit of measurement selected will be displayed for one second.

### 9.5 [P5] Select inches/millimetres

By pressing this button, the machine alternates the unit of measure of the wheel dimensions: if the unit of measure selected is in inches, select mm and vice versa. This selection is maintained even when the machine is shut-down.

The unit of measurement selected will be displayed for one second.

### 9.6 [P6] Select the imbalances view threshold

This button allows editing the imbalances view threshold. This procedure is intended for technical support personnel and is not described in this manual.

### 9.7 [P9] Not used

This button is not currently used in Service mode.

### 9.8 [F+P1] Not used

This button is not currently used in Service mode.

### 9.9 [F+P2] Select weight material in Fe/Zn, or Pb

Use this button to select the balancing weight material. The options available are listed in table T9.1. The selection of the material type slightly changes the balancing results because the weights in Iron/Zinc are lighter than those in Lead and therefore are larger. The machine takes account of these differences when calculating the imbalance.

**Table T9.1 Balancing weights materials**

Option	Type of balancing weight material	Notes
Fe	Iron or Zinc	This material has been set by default.
Pb	Lead	In some countries (such as those of the European Community), Lead weights are prohibited by law.

By pressing this button, the machine alternates the material type of the balancing weights: if the selected material is Iron/Zinc, select Lead and vice versa. This selection is maintained even when the machine is shut-down.

The option relative to the type of material selected will appear on the display for a second.

**Note:**

*if Lead has been selected as material, at every machine start-up, a message indicating the selection of this material will appear for one second after the initial test. See figure F9.2. This signal will not be viewed if Iron/Zinc is selected as material.*

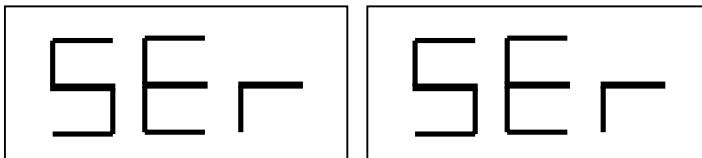


Fig. F9.2 Selection of the Lead balancing weights

### 9.10 [F+P3] Exit the SERVICE mode

This button allows the machine to exit the SERVICE mode and return to the NORMAL mode.

### 9.11 [F+P4] Read launch number counter

By pressing this button, the total number of balancing launches run by the machine will be displayed. The number of launches is shown on both displays. Figure F9.3 shows as an example of a machine's display that has run 1,234 balancing launches.

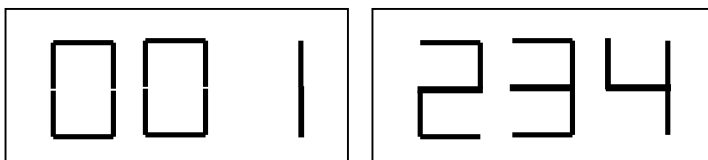


Fig. F9.3 - Display of the number of the balancing launches

Balancing launches that were interrupted are not included in the total count of balancing launches (for

example, those stopped by pressing [P10] Stop  or those interrupted by raising the wheel guard) and all those run in the SERVICE mode.

### 9.12 [F+P5] MENU Parameters

The Menu parameter is reserved for the technical support personnel and therefore is not described in this manual. Access to this menu is protected by password.



### 9.13 [F+P6] USB port

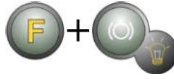
This button is not currently used in Service mode. By pressing this button, the writing `Usb` will appear on the display for one second.

### 9.14 [F+P9] MENU Test Programmes

This menu allows running tests for some machine functions. The Menu has the following options:

- Enc Encoder disc test;
- RPM Number of shaft RPMs test;
- SIG Pick-up signals test;
- dPy Display test.
- tAS Keypad test;
- UFc Converter voltage-frequency test.
- Ret Returns to the Service mode

To scroll through the different menu options, press [P4]  or [P5]  until the desired



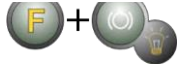
option is viewed, then press [F+P9] to confirm the selection.

**Note:**

*the test programmes listed are mainly reserved for technical support personnel but may also be run by end users as it does not impair machine operation.*

### 9.14.1 EnC Encoder disc test

This test allows controlling the function of the encoder which informs the machine on the angular position of the shaft. A number indicating the angular position will appear on the right display; this number must be between 0 and 255.



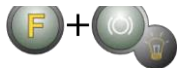
To exit the test programme, press [F+P9]

### 9.14.2 rPM number of shaft RPMs test

This test allows controlling the number of shaft RPMs during the launch. A number indicating the speed of the shaft will be viewed on the right display.



By pressing [P8] Start the machine will run a launch and at the end of this, it will display the number of shaft RPMs.



To exit the test programme, press [F+P9]

### 9.14.3 SIGPick-up signals test;

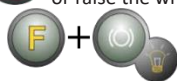
This programme allows checking the pick-up signal. To run the test, you will need to mount a balanced wheel with steel rim, 15" in diameter and 6" in width (or more similar as possible), on the machine. A 50 g weight must be applied the external side of the wheel.



By pressing [P8] Start, the machine will run continuous spinning and the pick-up signals respect to the three attenuation processes (Attenuation 1, Attenuation 2, Attenuation 4) will appear on the display in sequence.



To complete the test, press [P10] Stop or raise the wheel guard.



To exit the test programme, press [F+P9]

### 9.14.4 dPy Display test

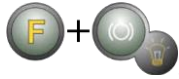
The display test program will light up all the LEDs and the 7-segment displays in sequence so you can

check their functioning. To turn on all the LEDs and display segments in sequence, press [P4]



or [P5]





To exit the test programme, press [F+P9]

### 9.14.5 tAS Keypad test;

The keypad test programme is used to check the operation of all the keys on the control panel. Every time a button is pressed, the code of the same key will appear on the display: for example, pressing [P8] Start

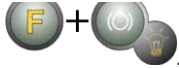


the code "P8" will be viewed, pressing [P10] Stop



the code "P10" will be viewed and so on.

The code of the key [P7]  is not displayed.



To exit the test programme, press [F+P9]

#### Note:

To run the keyboard test, the wheel guard must be raised or the display will always show the code of the key [P10]



Stop. This occurs because wheel guard and the [P10]

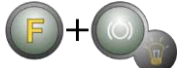


Stop button share the same input line to the electronic control board.

### 9.14.6 UFc Converter voltage-frequency test

The converter voltage-frequency test shows two numbers on the displays that represent the values of the internal conversion to the CPU-C1 electronic control circuit board.

These values are used by technical support personnel to determine the functioning state of the circuit board.



To exit the test programme, press [F+P9]

### 9.14.7 Re t Returns to the Service mode

This Test Programme menu option sets the machine back to the SERVICE mode

## 10. SIGNALS

### 10.1 Error codes

The machine reports error conditions by showing an error code on the display. The list of the error codes is shown in table T10.1.

**Table T10.1 – Error codes**

Error code	Description	Notes
000 to 009	Machine parameters	Contact technical support.
010	Reverse rotation of the wheel	Contact technical support.
011	Wheel speed too low	Check the mains voltage. If the checks do not lead to any results, contact technical support.
012	The wheel cannot be stopped at the end of the launch	Check the mains voltage. If the checks do not lead to any results, contact technical support.
013	Wheel speed too high	Contact technical support.
014	The wheel does not spin	Contact technical support.
015	Keys pressed or jammed at start-up	Release all buttons, then turn off or restart the machine. If the error persists, contact technical support.
016	Distance sensor not in rest position when the machine is switched on	Set the sensor to its rest position: the error should disappear. If the error persists, contact technical support.
017	Width sensor not in rest position when the machine is switched on	Set the sensor to its rest position: the error should disappear. If the error persists, contact technical support.
018	Reserved	
019	Communication processor failure	Turn the machine off or on. If the error persists, contact technical support. The machine can still be used but all functions related to the USB port are disabled.
020	Lack of communication with the eeprom memory	Turn the machine off and then on again. If the error persists, contact technical support.
021	Lack of machine calibration data or incorrect calibration data	Carry out calibration for the CAR/SUV Wheel Type and/or for the MOTOWheelType. If the error persists, contact technical support.  See also <b>E R R O 3 0</b> and <b>E R R O 3 1</b> .
022	Pick-up channel A too high	Excessive imbalance or anomaly. Turn the machine off and then on again. If the error persists, contact technical support.
023	Pick-up channel B too high	Excessive imbalance or anomaly. Turn the machine off and then on again. If the error persists, contact technical support.
024	Internal timer channel too high	Excessive imbalance or anomaly. Turn the machine off and then on again. If the error persists, contact technical support.

Error code	Description	Notes
025	Presence of weight during the Cal0 calibration phase	Remove the weight and repeat the launch of the Cal0 phase. If the error persists, contact technical support.
026	A launch without weight or failure of the pick-up A signal in the Cal2 calibration phase.	Apply the intended weight and repeat the launch. If the error persists, contact technical support.
027	A launch without weight or failure of the pick-up B signal in the Cal2 calibration phase.	Apply the intended weight and repeat the launch. If the error persists, contact technical support.
028	A launch with weight on the internal side during the Cal3 calibration phase. In this phase, the weight must be on the external side.	Remove the weight from the internal side and repeat the launch. If the error persists, contact technical support.
029	RESERVED	
030	Lack of calibration data for the CAR/SUV (auto-vehicle and off-road) Wheel Type	Carry out calibration for the CAR/SUV wheel Type.
031	Lack of calibration data for the MOTO (motorbike) Wheel Type	Carry out machine calibration for the MOTO Wheel Type.
032	WARNING: Width sensor not calibrated.	ONLY TECHNICAL PERSONNEL. Calibrate the Diameter sensor.
033	WARNING: Width sensor not calibrated.	ONLY TECHNICAL PERSONNEL. Calibrate the width sensor.
034	WARNING: The MOTO Wheel Type is activated: a different Programme Type other than ALU1 cannot be used.	Other Programme Types cannot be selected.
035	WARNING: The electromagnetic clamping brake is disabled. It is not possible to run the low speed SWI procedure.	Enable the electromagnetic clamping brake (if provided).
036	WARNING: Absence of wheel imbalance in DYNAMIC mode. It is not possible to run the low speed SWI procedure.	
037	WARNING: Absence of wheel imbalance in STATIC mode. It is not possible to run the low speed SWI procedure..	
038	WARNING: The MOTO Wheel Type is active. It is not possible to run the low speed SWI procedure.	The low speeds W I procedure is disabled for safety reasons



Error code	Description	Notes
039	WARNING/ERROR The Wheel guard is open : the requested action cannot be performed.	Check guard MICRO switch.
042	The SWI procedure did not reach the imbalance angular position.	The error can occur occasionally depending on the wheel and environmental conditions. If this error occurs on a frequent basis, contact technical support.
043	WARNING: The flange for motor bikes was not exactly vertical when [P8] Start was pressed during the MOTO Cal2 and Cal3 calibration phases.	Put the flange for motor bikes exactly vertical (and with the CAL reference on the upper part) then press [P8] Start.
044	WARNING: Diameter sensor disabled or missing. It is not possible to perform the action required.	ONLY TECHNICAL PERSONNEL. Make sure that the sensor is connected and enabled.
045	WARNING: Width sensor disabled or missing . It is not possible to perform the action required.	ONLY TECHNICAL PERSONNEL. Make sure that the sensor is connected and enabled.
046	WARNING: The Diameter sensor is enabled but disconnected.	NOTE: if [F+P2] is pressed the machine acquisition system is temporarily disabled and operation can be continued. The disabled status will last until the machine has been turned off. The red LED[6] In figure F3.1 flashes to indicate the temporary disabled status.
047	WARNING: The Width sensor is enabled but disconnected.	NOTE: if [F+P2] is pressed the machine acquisition system is temporarily disabled and operation can be continued. The disabled status will last until the machine has been turned off. The red LED[6] in figure F3.1 flashes to indicate the temporary disabled status.
048	WARNING: The Diameter sensor is too far from the calibration point.	ONLY TECHNICAL PERSONNEL. Re-position the Diameter sensor into the correct calibration position.
050	WARNING: Absence of wheel external imbalance. It is not possible to use the Hidden Weight program.	
051	WARNING: Hidden Weights programme: these selected point is too far from the external imbalance position.	The point must be included up to 120° from the external imbalance position.
052	WARNING: Hidden Weights programme: the external imbalance position is not between the selected W1 and W2 points.	Choose W1 and W2 points so that they include the external imbalance position.
055	WARNING: The static imbalance of the wheel is too low: the Optimisation programme cannot be used.	

Error code	Description	Notes
061	ERR OR: Serial control not acknowledged.	ONLY TECHNICAL PERSONNEL The serial control sent to the machine has not been acknowledged as valid.
062	ERROR: The pressed key is not permitted or an incorrect password has been entered.	Press the permitted key or enter the correct password.

## 10.2 Acoustic signals

The machine emits different acoustic signals based on its status. Acoustic signals are listed in table T10.2.

**Table T10.2 – Acoustic signals**




Signal	Meaning	Notes
Short beep	Selecting a programme or a function	
Long beep	Acquisition	Acquisition of a value (e.g. acquisition of wheel dimensions).
Double beep	Warning	A particular condition has occurred that requires the operator's attention.
Triple beep	Function not available or Error	The requested function is not available or that an error condition has occurred.
Short beep + long beep	Storing one or more values in the permanent memory (eeprom) of the circuit board	One or more values have been stored in the permanent memory of the circuit board (for example, at completion of calibration phases).
Intermittent beep	Adjustment	Signal used in some service programmes to simplify the adjustment of sensors.

The acoustic signal is also heard for about two seconds at machine start up allowing the operator to check the operation of the alarm (buzzer).

## 10.3 Special visual signals

The machine gives special visual signals in certain cases. The special visual signals are listed in table T10.3

**Table T10.3 – Special visual signals**

Signal	Meaning	Notes
Three dots lit on one or both displays	Imbalance exceeds 999 grams	This signal can be triggered due to: <ul style="list-style-type: none"> <li>• Lack of machine calibration;</li> <li>• incorrect measures of the wheel dimensions.</li> <li>• incorrect setting of the Wheel Type;</li> <li>• incorrect setting of the Programme Type.</li> </ul>
Flashing green STBY LED	The machine is in the STAND-BY mode	All LEDs and displays are switched off. To exit the STAND-BY mode, press any button (with the exception of [P7]  ).
The left (or right) display is flashing	<p>a) Attending the user's command</p> <p>b) The Diameter or Width sensor is not calibrated.</p>	<p>a) The user's command may be the pressing a key to confirm or continue the procedure in progress or the selecting of a value or a menu option.</p> <p>b) Call the technical support to carry on with the calibration of the Diameter and Width sensor. To continue with the operation, you can temporarily disable the sensors by pressing  +  .</p> <p>[F+P2]</p>

## 11. TROUBLESHOOTING

Below is a list of faults that may occur and that the user can solve if the cause is found among those indicated.

For any other malfunction or fault call in the technical support centre.

### **Machine does not switch on (monitor remains switched off)**

No power at the socket.

- Make sure that the mains power is present.
- Check the electrical power circuit in the workshop.

#### **The machine plug is defective.**

- Check if the plug is working properly and replace it if necessary.

#### **One of the FU1-FU2 fuses of the rear electrical panel has blown.**

- Replace the blown fuse.

#### **The monitor has not been switched on (only after installation).**

- Switch on the monitor by pressing the button located on the front of the monitor.

---

---

**The monitor's power supply connector (located on the rear of the monitor) is not correctly inserted.**

- Check for proper insertion of the connector.

**The diameters and width values measured with the automatic measuring devices do not match the rated values of the rims.**

**The sensors have not been positioned correctly during measurement.**

- Bring the sensors to the position shown in the manual and follow the instructions in the WHEEL DATA ENTRY section.

**The external sensor has not been calibrated.**

- Perform the sensor calibration procedure. See warning instructions at the end of the SENSOR CALIBRATION section.

**The automatic measuring devices are not working**

**The sensors were not at rest at start-up (A10) and the Manual data entry icon was selected, thus disabling the automatic sensor management (E10).**

- Return the sensors to the correct position.

**START has been pressed and the wheel fails to spin  
(the machine does not start)**

**The wheel guard is raised (the "A Cr" message is displayed).**

- Lower the guard.

**The wheel balancer provides unsteady unbalance values**

**The machine was jolted during the spin.**

- Repeat the wheel spin while making sure that nothing affects machine operation while acquisition is in progress.

**The machine does not firmly rest on the floor.**

- Make sure that the floor support is firm.

**The wheel is not locked correctly.**

- Tighten the locking ring nut firmly.

**Several spins are to be performed to balance the wheel**

**The machine was jolted during the spin.**

- Repeat the wheel spin while making sure that nothing affects machine operation while acquisition is in progress.

**The machine does not firmly rest on the floor.**

- Make sure that the floor support is firm.

**The wheel is not locked correctly.**

- Tighten the locking ring nut firmly.
- Make sure that the accessories used for centring are suitable and original.

**The machine has not been calibrated correctly.**

- Perform the sensitivity calibration procedure.

**The entered geometric data are not correct.**

- Make sure that the entered data correspond to the wheel dimensions and correct them if necessary.
- Carry out the external sensor calibration procedure (width).

## 12. MAINTENANCE



### WARNING

The producer declines all responsibility for claims deriving from the use of non original spare parts or accessories.



### WARNING

**Unplug the machine from the power supply and make sure that all moving parts have been locked before performing any adjustment or maintenance operation.**

**Do not remove or modify any part of the machine (except for service interventions).**



### CAUTION

Keep the work area clean.

**Never use compressed air and/or jets of water to remove dirt or residues from the machine.**

**Take all possible measures to prevent dust from building up or raising during cleaning operations.**

Keep the wheel balancer shaft, these securing ring nut, the centring cones and flange clean. These components can be cleaned using a brush previously dripped in environmentally friendly solvents.

Handle cones and flanges carefully so as to avoid accidental dropping and subsequent damage that would affect centring accuracy.

After use, store cones and flanges in a place where they are suitably protected from dust and dirt. If necessary, use ethyl alcohol to clean the display panel.

Perform the calibration procedure at least once every six months.

## 13. INFORMATION REGARDING MACHINE DEMOLITION

If the machine is to be scrapped, remove all electrical, electronic, plastic and metal parts and dispose of them separately in accordance with current provisions as prescribed by law.

## 14. ENVIRONMENTAL INFORMATION

The following disposal procedure shall be exclusively applied to the machines having the crossed-out bin

symbol on their data plate



This product may contain substances that can be hazardous to the environment and to human health if it is not disposed of properly.

The following information is therefore provided to prevent the release of these substances and to improve the use of natural resources.

Electrical and electronic equipment must never be disposed of in the usual municipal waste but must be separately collected for their proper treatment.

The crossed-out bin symbol, placed on the product and on this page, reminds the user that the product must be disposed of properly at the end of its life.

In this way it is possible to prevent that a non specific treatment of the substances contained in these products, or their improper use, or improper use of their parts may be hazardous to the environment or to human health. Furthermore, this helps to recover, recycle and reuse many of the materials contained in these products.