



M5300 and M7300 Mobile Radios with CH-721 Control Heads

VHF and 800 MHz
Motorcycle Applications



MANUAL REVISION HISTORY

REV.	DATE	REASON FOR CHANGE
A	Feb/09	Added references to 800 MHz M5300 radio, assembly and mounting figures, and headset/portable radio connection section. Revised optional cables section. Revised antenna test procedures.
B	Jun/09	Revised specifications, microphone part numbers, ring terminal part number, and optional cables.
C	Sep/09	Added VHF M7300 radio, updated specifications, email addresses, and maximum power and performance test procedures.

Harris Corporation, Public Safety and Professional Communications (PS&PC) Division continually evaluates its technical publications for completeness, technical accuracy, and organization. You can assist in this process by submitting your comments and suggestions to the following:

Harris Corporation
 PS&PC Division
 Technical Publications
 221 Jefferson Ridge Parkway
 Lynchburg, VA 24501

fax your comments to: 1-434-455-6851
 or
 e-mail us at: PSPC_TechPubs@harris.com

ACKNOWLEDGEMENT

This device is made under license under one or more of the following US patents: 4,590,473; 4,636,791; 5,148,482; 5,185,796; 5,271,017; 5,377,229; 4,716,407; 4,972,460; 5,502,767; 5,146,497; 5,164,986; 5,185,795; 5,226,084; 5,247,579; 5,491,772; 5,517,511; 5,630,011; 5,649,050; 5,701,390; 5,715,365; 5,754,974; 5,826,222; 5,870,405; 6,161,089; and 6,199,037 B1. DVSI claims certain rights, including patent rights under aforementioned U.S. patents, and under other U.S. and foreign patents and patents pending. Any use of this software or technology requires a separate written license from DVSI.

CREDITS

Harris, assuredcommunications, EDACS and OpenSky are registered trademarks of and ProVoice is a trademark of Harris Corporation.

AMBE is a registered trademark and IMBE, AMBE+, and AMBE+2 are trademarks of Digital Voice Systems, Inc. Bird is a registered trademark of Bird Electronic Corporation. Microsoft and Windows are registered trademarks of Microsoft Corporation. SmartSiren is a registered trademark of Federal Signal Corporation. All other brand and product names are trademarks, registered trademarks, or service marks of their respective holders.

NOTICE!

Information and descriptions contained herein are the property of Harris Corporation. Such information and descriptions may not be copied or reproduced by any means, or disseminated or distributed without the express prior written permission of Harris Corporation, PS&PC Division, 221 Jefferson Ridge Parkway, Lynchburg, VA 24501.

Repairs to this equipment should be made only by an authorized service technician or facility designated by the supplier. Any repairs, alterations or substitutions of recommended parts made by the user to this equipment not approved by the manufacturer could void the user's authority to operate the equipment in addition to the manufacturer's warranty.



This product conforms to the European Union WEEE Directive 2002/96/EC. Do not dispose of this product in a public landfill. Take it to a recycling center at the end of its life.

This manual is published by **Harris Corporation** without any warranty. Improvements and changes to this manual necessitated by typographical errors, inaccuracies of current information, or improvements to programs and/or equipment, may be made by **Harris Corporation** at any time and without notice. Such changes will be incorporated into new editions of this manual. No part of this manual may be reproduced or transmitted in any form or by any means, electronic or mechanical, including photocopying and recording, for any purpose, without the express written permission of **Harris Corporation**.

TABLE OF CONTENTS

<u>Section</u>	<u>Page</u>
1 REGULATORY AND SAFETY INFORMATION.....	6
1.1 SAFETY SYMBOL CONVENTIONS.....	6
1.2 RF ENERGY EXPOSURE AWARENESS AND CONTROL INFORMATION FOR FCC OCCUPATIONAL USE REQUIREMENTS.....	6
1.2.1 Federal Communications Commission Regulations.....	7
1.3 COMPLIANCE WITH RF EXPOSURE STANDARDS.....	7
1.3.1 Mobile Antennas.....	8
1.3.2 Approved Accessories.....	8
1.3.3 Contact Information.....	8
1.4 OCCUPATIONAL SAFETY GUIDELINES AND SAFETY TRAINING INFORMATION.....	9
1.5 COMMON HAZARDS.....	9
1.6 SAFE DRIVING RECOMMENDATIONS.....	10
1.7 OPERATING RULES AND REGULATIONS.....	10
1.8 OPERATING TIPS.....	11
2 SPECIFICATIONS.....	12
2.1 GENERAL.....	12
2.2 TRANSCEIVER.....	12
2.3 REGULATORY.....	14
3 INTRODUCTION.....	15
3.1 GENERAL DESCRIPTION.....	15
3.1.1 VHF-Band M7300 Radio.....	15
3.1.2 800 MHz-Band M5300 Radio.....	15
3.1.3 Dual-Band 700 and 800 MHz M7300 Radio.....	15
3.1.4 General Information.....	16
3.2 RELATED PUBLICATIONS.....	18
3.3 REPLACEMENT PARTS.....	19
3.4 TECHNICAL ASSISTANCE.....	19
4 UNPACKING AND CHECKING THE EQUIPMENT.....	20
4.1 GENERAL INFORMATION.....	20
4.2 MOBILE RADIO, CONTROL HEAD AND MICROPHONE.....	20
4.3 INSTALLATION KITS.....	22
4.4 ANTENNAS.....	25
4.5 OPTIONS AND ACCESSORIES.....	25
4.6 MATERIALS NOT SUPPLIED.....	27
5 PLANNING THE INSTALLATION.....	28
5.1 GENERAL INFORMATION.....	28
5.2 RECOMMENDED TOOLS.....	28
5.3 LOCATING COMPONENTS.....	31
5.4 DC POWER CONSIDERATIONS.....	32
6 RADIO MECHANICAL INSTALLATION.....	33
6.1 INSTALLING THE ADAPTER BRACKET.....	33
6.2 MOUNTING THE CASE AND CASE/ANTENNA BRACKET TO ADAPTER BRACKET.....	33
6.3 INSTALLING THE RADIO IN THE CASE.....	35
6.3.1 Install the Radio's Mounting Bracket.....	35
6.3.2 Install the Radio into Mounting Bracket.....	35
7 ANTENNA INSTALLATION.....	37
7.1 MOBILE ANTENNA INSTALLATION.....	37
7.1.1 Install the Mobile Antenna.....	37

TABLE OF CONTENTS

<u>Section</u>	<u>Page</u>
7.1.2 Calculating the Antenna Cable Length	37
7.1.3 Route Cable, Crimp-On TNC RF Connector and Connect It to the Radio	38
8 CONTROL HEAD MECHANICAL INSTALLATION	40
8.1 GENERAL INFORMATION	40
8.2 MOUNTING THE CONTROL HEAD	41
8.2.1 Selecting a Mounting Location	41
8.2.2 Control Head Adapter Bracket (Not Supplied)	43
8.2.3 Mounting the CH-721 Control Head	43
9 SPEAKER INSTALLATION	45
9.1.1 Selecting a Mounting Location	45
9.1.2 Mounting the Speaker	45
10 CABLE CONNECTIONS	46
10.1 DC POWER CONNECTIONS	46
10.1.1 Overview of On/Off Power Wiring Configurations	46
10.1.2 Alternator Whine Reject Filter Installation	46
10.1.3 DC Power Cable and Main Fuse Holder Installation	47
10.1.4 Control Head Power Cable Installation	49
10.2 CAN CABLE CONNECTIONS	52
10.2.1 General Information	52
10.2.2 Make CAN Link Terminations and Cable Connection	52
11 HEADSET/PORTABLE RADIO CONNECTIONS	54
11.1 CONNECTING A HEADSET TO THE RADIO (WITHOUT BELT BOX)	54
11.2 CONNECTING A HEADSET/PORTABLE RADIO TO THE MOBILE RADIO (WITH BELT BOX)	56
11.3 HEADSET OPERATION	58
12 MICROPHONE ATTACHMENT	59
13 OPTIONAL CABLES	60
13.1 M5300/M7300 OPTION CABLE CA-012349-001	60
13.2 HEADSET ADAPTER CABLE CA-012349-002	63
13.3 ACCESSORY CABLE 19B802554P24	64
13.4 SERIAL PROGRAMMING CABLES CA-013671-010 AND -020	65
13.5 CH-721 OPTION CABLE CA-011854-001	66
13.6 CH-721 SERIAL PROGRAMMING CABLE CA-104861	67
14 INITIAL POWER-UP TEST	68
15 SETTING MAXIMUM TRANSMIT POWER LEVEL AND ANTENNA PERFORMANCE TESTS	69
15.1 CHANGING OPERATING MODE FOR TESTS	69
15.1.1 Changing from OpenSky to Conventional	69
15.1.2 Changing from Conventional to OpenSky	70
15.2 REQUIRED TEST EQUIPMENT	70
15.3 TRANSMIT POWER LEVEL ADJUSTMENTS	71
15.3.1 General Information	71
15.3.2 Adjusting Maximum Transmit Output Power for EDACS/ProVoice, Conventional, and P25 Modes	71
15.3.3 Adjusting Maximum Transmit Output Power for OpenSky Mode (Optional)	72
15.4 TRANSMITTING INTO A DUMMY LOAD	73
15.5 TRANSMITTING INTO THE MOBILE ANTENNA	75
15.6 TEST PERFORMANCE DATA FORM	77

TABLE OF CONTENTS (Continued)	
<u>Section</u>	<u>Page</u>
16 COMPLETE THE INSTALLATION	78
17 WARRANTY	79

LIST OF FIGURES	
	<u>Page</u>
Figure 5-1: Typical Motorcycle Installation (Full View from Rear).....	29
Figure 5-2: Typical Motorcycle Installation (Partial View of Radio Case and Brackets from Right Side)	29
Figure 5-3: M5300/M7300 Mobile Radio inside Weather-Resistant Motorcycle Radio Case.....	30
Figure 5-4: M5300/M7300 Mobile Radio — Front and Rear Views (Radio Removed from Case)	31
Figure 6-1: Assembling, Mounting and Installing the Radio Case and Brackets	34
Figure 6-2: Alternate Mounting for Adapter Bracket.....	35
Figure 6-3: Installing the Radio’s Mounting Bracket and Filter into the Motorcycle Radio Case	36
Figure 7-1: Crimping Instructions for TNC RF Connector	38
Figure 8-1: CH-721 Scan Model Control Head Front Panel	40
Figure 8-2: CH-721 System Model Control Head Front Panel	40
Figure 8-3: CH-721 Rear Panel (both control head models).....	41
Figure 8-4: Typical CH-721 Control Head Installation on a Motorcycle (Using the Standard U-Shaped Mounting Bracket).....	42
Figure 8-5: Optional Control Head Mounting Pedestal (Part Number MACDOS0012).....	42
Figure 10-1: CAN Terminators and Control Head-to-Radio CAN Cable Connection	53
Figure 11-1: Headset-to-Mobile Radio Connection	55
Figure 11-2: Headset/Portable Radio-to-Mobile Radio Connection	57
Figure 12-1: Attaching the Microphone to the CH-721 Control Head.....	59
Figure 13-1: M5300/M7300 Option Cable CA-012349-001	60
Figure 13-2: Headset Adapter Cable CA-012349-002	63
Figure 13-3: Accessory Cable 19B802554P24	64
Figure 13-4: Programming Cables CA-013671-010 and CA-013671-020.....	65
Figure 13-5: CH-721 Option Cable CA-011854-001	66
Figure 13-6: Programming Cable CA-104861	67
Figure 15-1: Setting Maximum RF Output Power Level via RPM’s System Setup Dialog Box.....	72
Figure 15-2: Wattmeter Connections for Antenna System Tests	74

LIST OF TABLES	
	<u>Page</u>
Table 1-1: Recommended Minimum Safe Lateral Distance from Transmitting Antenna.....	8
Table 4-1: Motorcycle Installation Kits for M5300/M7300 Mobile Radios with CH-721 Control Heads.....	22
Table 4-2: Contents of M5300/M7300 Motorcycle Installation Kits	22
Table 4-3: Antennas for Motorcycle Applications of the M5300 and M7300 Mobile Radios.....	25
Table 4-4: Additional Options and Accessories for M5300 and M7300 Mobile Radios	25
Table 4-5: Options and Accessories for CH-721 Control Heads.....	26
Table 4-6: Headset-Related Options for Use with M5300 and M7300 Mobile Radios.....	27
Table 13-1: M5300/M7300 Option Cable CA-012349-001 Interconnections.....	61
Table 15-1: Required Test Equipment	70

1 REGULATORY AND SAFETY INFORMATION

1.1 SAFETY SYMBOL CONVENTIONS

The following conventions are used in this manual to alert the user to general safety precautions that must be observed during all phases of operation, installation, service, and repair of this product. Failure to comply with these precautions or with specific warnings elsewhere violates safety standards of design, manufacture, and intended use of the product. Harris Corporation assumes no liability for the customer's failure to comply with these standards.



The **WARNING** symbol calls attention to a procedure, practice, or the like, which, if not correctly performed or adhered to, could result in personal injury. Do not proceed beyond a **WARNING** symbol until the conditions identified are fully understood or met.



The **CAUTION** symbol calls attention to an operating procedure, practice, or the like, which, if not performed correctly or adhered to, could result in damage to the equipment or severely degrade equipment performance.



The **NOTE** symbol calls attention to supplemental information, which may improve system performance or clarify a process or procedure.

1.2 RF ENERGY EXPOSURE AWARENESS AND CONTROL INFORMATION FOR FCC OCCUPATIONAL USE REQUIREMENTS

Before using the two-way mobile radio, read this important RF energy awareness and control information and operational instructions to ensure compliance with RF exposure guidelines.



This radio is intended for use in occupational/controlled conditions, where users have full knowledge of their exposure and can exercise control over their exposure to remain below RF exposure limits. This radio is **NOT** authorized for general population, consumer, or any other use.



Changes or modifications not expressly approved by Harris could void the user's authority to operate the equipment.

This two-way radio uses electromagnetic energy in the radio frequency (RF) spectrum to provide communications between two or more users over a distance. It uses RF energy or radio waves to send and receive calls. RF energy is one form of electromagnetic energy. Other forms include, but are not limited to, electric power, sunlight, and x-rays. RF energy, however, should not be confused with these other forms of electromagnetic energy, which, when used improperly, can cause biological damage. Very high levels of x-rays, for example, can damage tissues and genetic material.

Experts in science, engineering, medicine, health, and industry work with organizations to develop standards for exposure to RF energy. These standards provide recommended levels of RF exposure for

both workers and the general public. These recommended RF exposure levels include substantial margins of protection. All two-way radios marketed in North America are designed, manufactured, and tested to ensure they meet government-established RF exposure levels. In addition, manufacturers also recommend specific operating instructions to users of two-way radios. These instructions are important because they inform users about RF energy exposure and provide simple procedures on how to control it. Refer to the following websites for more information on what RF energy exposure is and how to control exposure to assure compliance with established RF exposure limits:

<http://www.fcc.gov/oet/rfsafety/rf-faqs.html>

<http://www.osha.gov/SLTC/radiofrequencyradiation/index.html>

1.2.1 Federal Communications Commission Regulations

Before marketing in the United States, the M5300 and M7300 two-way mobile radios were tested to ensure compliance with FCC RF energy exposure limits for two-way mobile radios. When two-way radios are used as a consequence of employment, the FCC requires users to be fully aware of and able to control their exposure to meet occupational requirements. Exposure awareness can be facilitated by the use of a label directing users to specific user awareness information. Each radio has an RF exposure product label. Also, this Installation and Product Safety Manual and the applicable Operator's Manual include information and operating instructions required to control RF exposure and to satisfy compliance requirements.

1.3 COMPLIANCE WITH RF EXPOSURE STANDARDS

The M5300 and M7300 two-way mobile radios are designed and tested to comply with a number of national and international standards and guidelines regarding human exposure to RF electromagnetic energy. The radios comply with the IEEE and ICNIRP exposure limits for occupational/controlled RF exposure environment at duty-cycle times of up to 50% (50% transmit, 50% receive), and they are authorized by the FCC for occupational use. In terms of measuring RF energy for compliance with the FCC exposure guidelines, each radio's antenna radiates measurable RF energy only while it is transmitting (talking), not while it is receiving (listening), or in a standby mode.

The M5300 and M7300 two-way mobile radios comply with the following RF energy exposure standards and guidelines:

- United States Federal Communications Commission (FCC), Code of Federal Regulations; 47 CFR § 2 sub-part J.
- American National Standards Institute (ANSI)/Institute of Electrical and Electronic Engineers (IEEE) C95.1-2005.
- Institute of Electrical and Electronic Engineers (IEEE) C95.1-2005.
- IC Standard RSS-102, Issue 2, 2005: "Spectrum Management and Telecommunications Radio Standards Specification. Radiofrequency Exposure Compliance of Radiocommunication Apparatus (All Frequency Bands)."



Table 1-1 lists the recommended minimum safe lateral distances for a controlled environment and for unaware bystanders in an uncontrolled environment, from transmitting antennas (i.e., monopoles over a ground plane, or dipoles) at rated radio power for a mobile radio installed in a vehicle. Transmit only when unaware bystanders are at the uncontrolled recommended minimum safe lateral distance away from the transmitting antenna.

Based on the highest radiated RF power and the highest gain antenna used with the radio in a motorcycle installation, the distances listed in Table 1-1 are considered as safe distances for controlled and uncontrolled environments with the radio transmitting at a maximum 50% duty cycle.

Table 1-1: Recommended Minimum Safe Lateral Distance from Transmitting Antenna

ANTENNA PART NUMBER (Catalog Number)	ANTENNA DESCRIPTION	RECOMMENDED MINIMUM LATERAL HUMAN BODY DISTANCE FROM TRANSMITTING ANTENNA	
		CONTROLLED ENVIRONMENT (Centimeters)	UNCONTROLLED ENVIRONMENT (Centimeters)
LE-OM150K.125/TNC	136 to 174 MHz; 2.5 dBd Gain	53	118
LE-OM806HDBKTNCD5	800 MHz; 3.5 dBd Gain	28	72



A radio intended for a motorcycle installation must be configured to not exceed a transmit output power of 20 watts. Refer to Section 15.3 on page 71 for additional information. **A radio intended for a non-motorcycle installation should not be used in a motorcycle installation unless it is reprogrammed per the procedures presented in Section 15.3.**



The dual-band M7300 mobile radio can operate on both 700 and 800 MHz bands. **However, as of the publication of this manual, motorcycle applications are limited to the 800 MHz band only.**

1.3.1 Mobile Antennas

The antenna for the mobile radio must be installed in accordance with Section 7 in this manual and instructions included with the antenna.

Use only the approved/supplied antenna(s) or an approved replacement antenna. Unauthorized antennas, modifications, or attachments can cause the FCC RF exposure limits to be exceeded.

1.3.2 Approved Accessories

The radio has been tested and meets FCC RF guidelines when used with accessories supplied or designated for use with it. Use of other accessories may not ensure compliance with the FCC's RF exposure guidelines, and may violate FCC regulations. For a list of approved accessories refer to Section 4 in this manual (begins on page 20) and/or Harris' Products and Services Catalog.

1.3.3 Contact Information

For additional information on RF exposure and other information, contact Harris using one of the contact links listed in Section 3.4 on page 19.

1.4 OCCUPATIONAL SAFETY GUIDELINES AND SAFETY TRAINING INFORMATION

To ensure bodily exposure to RF electromagnetic energy is within the FCC allowable limits for occupational use. Always adhere to the following basic guidelines:

- The push-to-talk button should only be depressed when intending to send a voice message.
- The radio should only be used for necessary work-related communications.
- The radio should only be used by authorized and trained personnel. It should never be operated by children.
- Do not attempt any unauthorized modification to the radio. Changes or modifications to the radio may cause harmful interference and/or cause it to exceed FCC RF exposure limits. Only qualified personnel should service the radio.
- Always use Harris-authorized accessories (antennas, control heads, speakers/mics, etc.). Use of unauthorized accessories can cause the FCC RF exposure compliance requirements to be exceeded.

The information listed above provides the user with information needed to make him or her aware of a RF exposure, and what to do to assure that this radio operates within the FCC exposure limits of this radio.

1.5 COMMON HAZARDS



The operator of any mobile radio should be aware of certain hazards common to the operation of vehicular radio transmissions. Possible hazards include but are not limited to:

- **Explosive Atmospheres** — Just as it is dangerous to fuel a vehicle while its motor running, be sure to turn the radio **OFF** while fueling the vehicle. If the radio is mounted in the trunk of the vehicle, **DO NOT** carry containers of fuel in the trunk.
Areas with potentially explosive atmosphere are often, but not always, clearly marked. Turn the radio **OFF** when in any area with a potentially explosive atmosphere. It is rare, but not impossible that the radio or its accessories could generate sparks.
- **Interference To Vehicular Electronic Systems** — Electronic fuel injection systems, electronic anti-skid braking systems, and electronic cruise control systems, etc., are typical types of electronic devices that can malfunction due to the lack of protection from radio frequency (RF) energy present when transmitting. If the vehicle contains such equipment, consult the dealer for the make of vehicle and enlist his aid in determining if such electronic circuits perform normally when the radio is transmitting.
- **Electric Blasting Caps** — To prevent accidental detonation of electric blasting caps, **DO NOT** use two-way radios within 1000 feet (305 meters) of blasting operations. Always obey the “**Turn Off Two-Way Radios**” (or equivalent) signs posted where electric blasting caps are being used (OSHA Standard: 1926.900).
- **Radio Frequency Energy** — To prevent burns or related physical injury from radio frequency energy, do **not** operate the radio’s transmitter when anyone near the motorcycle is within the minimum safe distance from the antenna as specified in Table 1-1. Refer to Section 1.2 for additional information.
- **Vehicles Powered By Liquefied Petroleum (LP) Gas** — Radio installation in vehicles powered by liquefied petroleum gas, where the LP gas container is located in the trunk or other sealed-off space

within the interior of the vehicle, must conform to the National Fire Protection Association standard **NFPA 58**. This requires:

- The space containing the radio equipment must be isolated by a seal from the space containing the LP gas container and its fittings.
- Outside filling connections must be used for the LP gas container.
- The LP gas container space shall be vented to the outside of the vehicle.

1.6 SAFE DRIVING RECOMMENDATIONS

The American Automobile Association (AAA) advocates the following key safe driving recommendations:

- Read the literature on the safe operation of the radio.
- Use both hands to steer and keep the microphone in its hanger whenever the vehicle is in motion.
- Place calls only when the vehicle is stopped.
- When talking from a moving vehicle is unavoidable, drive in the slower lane. Keep conversations brief.
- If a conversation requires taking notes or complex thought, stop the vehicle in a safe place and continue the call.
- Whenever using a mobile radio, exercise caution.

1.7 OPERATING RULES AND REGULATIONS

Two-way radio systems must be operated in accordance with the rules and regulations of the local, regional, or national government.

In the United States, the mobile radio must be operated in accordance with the rules and regulations of the Federal Communications Commission (FCC). Operators of two-way radio equipment, must be thoroughly familiar with the rules that apply to the particular type of radio operation. Following these rules helps eliminate confusion, assures the most efficient use of the existing radio channels, and results in a smoothly functioning radio network.

When using a two-way radio, remember these rules:

- It is a violation of FCC rules to interrupt any distress or emergency message. The radio operates in much the same way as a telephone “party line.” Therefore, always listen to make sure the channel is clear before transmitting. Emergency calls have priority over all other messages. If someone is sending an emergency message – such as reporting a fire or asking for help in an accident, do not transmit unless assistance can be offered.
- The use of profane or obscene language is prohibited by Federal law.
- It is against the law to send false call letters or false distress or emergency messages. The FCC requires keeping conversations brief and confine them to business. To save time, use coded messages whenever possible.
- Using the radio to send personal messages (except in an emergency) is a violation of FCC rules. Send only essential messages.
- It is against Federal law to repeat or otherwise make known anything overheard on the radio. Conversations between others sharing the channel must be regarded as confidential.

- The FCC requires self-identification at certain specific times by means of call letters. Refer to the rules that apply to the particular type of operation for the proper procedure.
- No changes or adjustments shall be made to the equipment except by an authorized or certified electronics technician.



Under U.S. law, operation of an unlicensed radio transmitter within the jurisdiction of the United States may be punishable by a fine of up to \$10,000, imprisonment for up to two (2) years, or both.

1.8 OPERATING TIPS

The following conditions tend to reduce the effective range of two-way radios and should be avoided whenever possible:

- Operating the radio in areas of low terrain, or while under power lines or bridges.
- Obstructions such as mountains and buildings.



In areas where transmission or reception is poor, communication improvement may sometimes be obtained by moving a few yards in another direction, or moving to a higher elevation.

2 SPECIFICATIONS¹

2.1 GENERAL

Dimensions, Remote-Mount Mobile Radio: (Height x Width x Depth)	2.0 x 6.9 x 9.2 inches (5.1 x 17.5 x 23.4 centimeters) (Does <u>not</u> include space required for mounting bracket and cables at rear of radio)
Dimensions, Control Head: (Height x Width x Depth)	2.4 x 6.9 x 3.9 inches (6 x 17.5 x 10 centimeters) (Does <u>not</u> include bracket and mounting screws)
Dimensions, Motorcycle Radio Case: (Height x Width x Depth)	4.6 x 10.1 x 17.9 inches (11.7 x 25.7 x 45.5 centimeters) (Does <u>not</u> include space required for brackets, cables, antenna, and key access)
Weight, Remote-Mount Mobile Radio:	5.25 pounds (3.69 kilograms), less bracket
Weight, Control Head:	1.25 pounds (0.57 kilograms), less bracket
Operating Ambient Temperature Range:	-22 to +140° Fahrenheit (-30 to +60° Celsius)
Storage Temperature Range:	-40 to +185° Fahrenheit (-40 to +85° Celsius)
Altitude:	15,000 feet (4572 meters) maximum
DC Supply Voltage Operating Range:	+13.6 Vdc ±10% (Normal range per TIA-603)
DC Supply Current Requirements:	
Receive (includes control head):	
With Speaker Muted:	1.1 amps maximum
With 0.5-Watt Speaker Output Power:	1.5 amps maximum
With 10-Watt Speaker Output Power:	3.5 amps maximum
With 15-Watt Speaker Output Power:	4.0 amps maximum
Transmit (includes control head):	
VHF Radio at 15 Watts:	7 amps maximum, 5 amps typical
VHF Radio at 20 Watts:	8 amps maximum, 6 amps typical
700 & 800 MHz Radio at 12 Watts:	8 amps maximum, 6 amps typical
700 & 800 MHz Radio at 20 Watts:	10 amps maximum, 8.8 amps typical
Quiescent/Off Current:	
Mobile Radio:	100 microamps maximum
Control Head:	100 microamps maximum

2.2 TRANSCEIVER

Frequency Ranges of VHF Radio:

Receive:	136 to 174 MHz
Transmit:	136 to 174 MHz

¹ These specifications are primarily intended for the use of the installation technician. See the appropriate Specifications Sheet for the complete specifications.

Frequency Ranges of 700 & 800 MHz Radio (See footnote ²):

Receive:

700 MHz Operation: 764 to 767 MHz, 769 to 775 MHz and 773 to 776 MHz (repeater and talk-around operations) [See footnote ³]
 800 MHz Operation: 851 to 869 MHz (repeater and talk-around operations)

Transmit:

700 MHz Talk-Around Operation: 764 to 767 MHz, 769 to 775 MHz and 773 to 776 MHz
 700 MHz Repeater Operation: 794 to 797 MHz, 799 to 805 MHz and 803 to 806 MHz [See footnote ⁴]
 800 MHz Talk-Around Operation: 851 to 869 MHz
 800 MHz Repeater Operation: 806 to 824 MHz

Transmit Output Power:

136 to 174 MHz RF Channels: 10 to 50 watts (see **WARNING** below)
 800 MHz RF Channels: 5 to 35 watts (see **WARNING** below)



Motorcycle applications of the M5300 and M7300 mobile radios are limited to 20 watts of maximum transmit RF output power. Refer to Section 1.2 (page 6), Section 5.4 (page 32), and Section 15 (page 69) for additional information.

Channel Spacing: 12.5 kHz or 25 kHz or 30 kHz (mode dependent)
Voice and Data Communications Modes: Half-Duplex
Frequency Stability: ±1.5 ppm with AFC disabled; ±0.5 ppm with AFC
Receiver Sensitivity:
 VHF P25 Mode (TIA-102 Method): -116 dBm minimum at 5% BER (static)
 VHF EDACS & Conventional Modes: -119 dBm minimum at 12 dB SINAD (25 kHz channels)
 800 MHz OTP Mode: -111 dBm minimum at 1% BER (static)
 800 MHz P25 Mode (TIA-102 Method): -116 dBm minimum at 5% BER (static)
 800 MHz EDACS Mode: -118 dBm minimum at 12 dB SINAD
Receiver Intermodulation Rejection: 77 dB typical
Audio Frequency Response: 300 to 3000 Hz
Audio Output Power from Control Head: 15 watts RMS minimum into 4-ohm external speaker;
 1 watt into 4-ohm headset
Audio Distortion from Control Head: < 5% at 5 watts RMS into 4-ohm external speaker
Voice-Coding Method:
 OTP Mode: Advanced Multi-Band Excitation (AMBE™)
 EDACS, ProVoice and P25 Modes: Improved Multi-Band Excitation (IMBE™)
 P25 Phase 1 Mode: Advanced Multi-Band Excitation Plus (AMBE+™)
OpenSky Data Rate: 19.2 kbps (9600 symbols per second)

² 700 MHz RF bands are listed for reference only. Motorcycle applications are limited to VHF and 800 MHz RF bands only.

³ 764 to 767 MHz and 773 to 776 MHz per old FCC 700 MHz band plan. 769 to 775 MHz added August 30, 2007 by new FCC 700 MHz band plan.

⁴ 764 to 767 MHz, 773 to 776 MHz, 794 to 797 MHz and 803 to 806 MHz per old FCC 700 MHz band plan. 769 to 775 MHz and 799 to 805 MHz added August 30, 2007 by new FCC 700 MHz band plan.

OpenSky Compressed Voice
Relative Data Rate: 2400 bps

2.3 REGULATORY

FCC Type Acceptance:
VHF Radio: OWDTR-0055-E
700 & 800 MHz Radio: OWDTR-0051-E

Applicable FCC Rules: Part 15 and Part 90

Industry Canada Certification:
VHF Radio: 3636B-0055
700 & 800 MHz Radio: 3636B-0051

Applicable Industry Canada Rules: RSS-119

3 INTRODUCTION

This installation and product safety manual covers motorcycle applications of the M5300 and M7300 mobile radios. Instructions are included for radio installation and testing, along with applicable safety information.

3.1 GENERAL DESCRIPTION

The M5300 and M7300 mobile radios are high-performance digital mobile radios. Three (3) different radios are available for motorcycle applications:

3.1.1 VHF-Band M7300 Radio

The VHF-band M7300 mobile radio can operate in the 136 to 174 MHz RF band with the following radio systems/standards:

- APCO Project 25 Phase I compliant Common Air Interface (P25 CAI) trunked radio networks;
- Talk-around communications in accordance with the APCO Project 25 Phase I standard; and,
- Conventional FM repeater-based and FM talk-around voice communications in the VHF-band in accordance with the TIA/EIA-603 conventional land-mobile radio standard.

The VHF-band M7300 radio has a high-power transmit rating of 50 watts. However, motorcycle applications are limited to 20 watts.

3.1.2 800 MHz-Band M5300 Radio

The 800 MHz M5300 mobile radio can operate with the following radio systems/standards:

- 800 MHz Enhanced Digital Access Communications System (EDACS®) trunked radio networks;
- 800 MHz ProVoice™ trunked radio networks;
- 800 MHz APCO Project 25 Phase I compliant Common Air Interface (P25 CAI) trunked radio networks; and,
- Conventional FM repeater-based and FM talk-around voice communications in the 800 MHz band in accordance with the TIA/EIA-603 conventional land-mobile radio standard.

800 MHz operating bands of the 800 MHz M5300 mobile radio include 806 to 824 MHz repeater input band (mobile transmit) and the 851 to 869 MHz band used for repeater output and talk-around communications. In high-power transmit mode on an 800 MHz RF channel, the radio's rated transmit output power is 35 watts. However, motorcycle applications are limited to 20 watts.

3.1.3 Dual-Band 700 and 800 MHz M7300 Radio

The dual-band 700 and 800 MHz M7300 mobile radio can operate with the following radio systems/standards:

- 700 MHz and 800 MHz OpenSky® trunked radio networks using the OpenSky Trunking Protocol (OTP);
- 800 MHz Enhanced Digital Access Communications System (EDACS®) trunked radio networks;
- 800 MHz ProVoice™ trunked radio networks;
- 800 MHz APCO Project 25 Phase I compliant Common Air Interface (P25 CAI) trunked radio networks;
- 700 MHz talk-around communications in accordance with the APCO Project 25 Phase I standard; and,

- Conventional FM repeater-based and FM talk-around voice communications in 700 and 800 MHz bands in accordance with the TIA/EIA-603 conventional land-mobile radio standard.

700 MHz operating bands of the dual-band M7300 mobile radio include the repeater output bands (mobile receive) of 764 to 767 MHz, 769 to 775 MHz and 773 to 776 MHz, and the repeater input bands (mobile transmit) of 794 to 797 MHz, 799 to 805 MHz and 803 to 806 MHz. The radio also provides talk-around operation in the 764 to 767 MHz, 769 to 775 MHz and 773 to 776 MHz bands. In high-power transmit mode on a 700 MHz RF channel, the radio's rated transmit output power is 19 watts.

800 MHz operating bands of the dual-band M7300 mobile radio include 806 to 824 MHz repeater input band (mobile transmit) and the 851 to 869 MHz band used for repeater output and talk-around communications. In high-power transmit mode on an 800 MHz RF channel, the radio's rated transmit output power is 35 watts. However, motorcycle applications are limited to 20 watts.



NOTE

The dual-band M7300 mobile radio can operate on both 700 and 800 MHz bands. **However, as of the publication of this manual, motorcycle applications are limited to the 800 MHz band only.**

3.1.4 General Information

In motorcycle applications, the radio is mounted in a weather-resistant case. This case is secured to the motorcycle's frame behind the seat of the motorcycle. The radio's control head is located near the motorcycle operator position. The radio is shown in the case in Figure 5-3 on page 30.

Control heads used with the M5300 and M7300 mobile radios include the CH-721 Scan and the CH-721 System model control heads. See Figure 8-1 through Figure 8-3 (pages 40 through 41). Both heads feature a large 3-line graphical vacuum-florescent display, front panel controls and buttons for user control of the mobile radio, an internal high-power audio amplifier to drive an externally-connected speaker, and a front panel microphone connector. The CH-721 System control head also has a 12-button numeric keypad that provides Dual-Tone Multi-Frequency (DTMF) functionality and easier operator system/group selection control at the control head's front panel.

The radio is remotely controlled by a control head via a Controller Area Network (CAN) link between the radio and control head. A 3-wire CAN cable provides the CAN link interconnection between the two units. The CAN link carries digitized microphone and speaker audio, controlling data such as button presses and radio messages, and user data such as that for a mobile data terminal connected to the serial port of the radio or control head. For proper operation, the CAN link must be terminated appropriately on each end.

As shown in Figure 8-3 on page 41, the CH-721 Scan and System model control heads have several connectors located on the head's rear panel. These connectors include a DC power connector, two (2) CAN port connectors used for CAN link interconnections, an external speaker connector, a 9-pin serial port connector for connecting optional equipment such as a mobile data terminal, and a 25-pin accessory connector. Both CH-721 models can interface to an optional Federal Signal Electronic siren/light control system for broadcasting via a public address (PA) speaker.

The radio must be powered by an external +13.6-volt (nominal) DC power source. In motorcycle applications, the motorcycle's electrical system is utilized as the source of DC power. The control head connected to the radio is also powered by the same DC power source, but separately fused. When the control head is powered-up by the operator, it "wakes up" the radio by transmitting data to the radio via the CAN link.

The radio provides half-duplex voice and data communications. Voice communications are accomplished via a "push-to-talk" (PTT) type microphone and a speaker connected to the control head.

For data communications, the radio has an industry-standard 9-pin serial interface port for connecting optional data-type equipment, such as a Mobile Data Terminal (MDT), a laptop PC, an external display, or a key-entry device. This port works seamlessly with equipment from popular manufacturers and off-the-shelf applications. OpenSky employs User Datagram Protocol over Internet Protocol (UDP/IP) data packet transfers, providing “plug and play” connectivity for data-type devices.

The radio and control head exceed tough environmental specifications included within military standard MIL-STD-810F, the radio industry standard TIA/EIA-603, and the radio standard established by the U.S. Forest Service.

A radio operating on an OpenSky radio network uses Time-Division Multiple-Access (TDMA) digital modulation technology on the radio frequency link. TDMA allows multiple radio users to share a single RF channel. In addition, a single RF channel can support simultaneous digital voice and data communications.

OpenSky employs Advanced Multi-Band Excitation (AMBE) speech and data compression technology developed by Digital Voice Systems, Inc. When operating on an OpenSky radio network, AMBE gives an M5300/M7300 radio the ability to provide exceptional voice quality via the limited bandwidth of the radio frequency path, even when the received RF signal is weak (i.e., even in “fringe” areas). AMBE is performed by a Digital Signal Processor (DSP) integrated circuit within the radio programmed to perform an AMBE compression algorithm during mobile transmissions, and an AMBE expansion algorithm during mobile reception.

Speech compression electronic circuitry—be it AMBE or another type such as IMBE—is sometimes referred to as “vocoding” circuitry for voice coding, or simply a “vocoder” circuit.

The M7300 mobile radio also supports radio operation on APCO Project 25 Phase I compliant Common Air Interface (P25 CAI) trunked radio networks, and operation in a talk-around mode in accordance with the APCO Project 25 Phase I standard. P25 radio systems utilize Improved Multi-Band Excitation (IMBE) speech/data compression technology, also developed by Digital Voice Systems, Inc.

Like AMBE technology, IMBE technology gives the radio the ability to deliver exceptional voice quality, even in areas where the received RF signal strength is weak. IMBE replicates human speech better than other voice compression technologies, resulting in better voice quality and better speaker recognition. The Telecommunications Industry Association (TIA) funded an independent study to evaluate compression technologies. The findings showed that when compared with other industry-recognized compression technologies, IMBE provided the highest voice quality. In the study, radio users were asked to listen to coded speech produced by four different compression technologies (i.e., vocoder circuits) operating under a variety of conditions. The users rated the speech on a scale of one to five, with five being the best quality. Under each operating condition, IMBE was rated the best.

The M5300 and M7300 mobile radios can also operate using Harris’ digital voice technology called ProVoice. Like P25 radio systems, ProVoice also employs the Improved Multi-Band Excitation (IMBE™) speech/data compression technology.

EDACS and ProVoice trunked radio networks employ analog FM and 2-level Gaussian Frequency-Shift Keying (GFSK) modulation techniques on the RF channels. Data is transmitted on an RF channel at a 9600 baud rate.

For over-the-air secure radio communications, the M5300 and M7300 mobile radios may be equipped with 64-bit DES (Data Encryption Standard) encryption or with 128/256-bit AES (Advanced Encryption Standard) encryption. With encryption, voice and/or user data signals transmitted and received by the radio on an RF channel are digitally encrypted (“scrambled”) to virtually eliminate unauthorized monitoring via the RF channel.



Encryption requires an encryption-capable radio.

Cryptographic keys are stored in the radio by the radio system administration personnel. Keys can be sent to an M7300 radio via an RF channel if it is equipped with the Over-the-Air Rekeying (OTAR) option. As of the publication of this manual, the OTAR option is not available for the M5300 radio.



Harris recommends the buyer use only a Harris-authorized representative to install and service this product. The warranties provided to the buyer under the terms of sale shall be null and void if this product is installed or serviced improperly, and Harris shall have no further obligation to the buyer for any damage caused to the product or to any person or personal property.

3.2 RELATED PUBLICATIONS

The following publications contain additional information about the M5300 and M7300 mobile radios:

- M5300 Quick Guide for EDACS/ProVoice and Conventional Modes: MM-013232-001
- M5300 Quick Guide for OpenSky: MM-012997-001
- M5300 Operator's Manual for EDACS/ProVoice, OpenSky and Conventional Modes: MM-012125-001
- M7300 Quick Guide for EDACS/ProVoice, P25 and Conventional Modes: MM-014369-001
- M7300 Quick Guide for OpenSky: MM-014368-001
- M7300 Operator's Manual for EDACS/ProVoice, OpenSky, P25 and Conventional Modes: MM-014716-001
- M7300 Maintenance Manual, VHF: MM-017065-001
- M5300 and M7300 Maintenance Manual, 700 and 800 MHz: MM-014718-001

Quick guides are included with each radio equipment package when it ships from the factory. Operator manuals, installation manuals, maintenance manuals, and quick guides are available at www.rfcomm.harris.com/publicsafety via a Wireless Systems' Wireless Information Center login and Tech Link.

3.3 REPLACEMENT PARTS

Replacement parts can be ordered through the Customer Resource Center. To order replacement parts through the Customer Resource Center, call, fax or e-mail our ordering system:

United States and Canada:

- Phone Number: 1-800-368-3277 (toll free)
- Fax Number: 1-800-833-7592 (toll free)
- E-mail: PSPC_tac@harris.com

International:

- Phone Number: 1-434-455-6403
- Fax Number: 1-434-455-6676
- E-mail: PSPC_CustomerFocus@harris.com

3.4 TECHNICAL ASSISTANCE

Should the mobile radio or control head require repair, or if there are questions or concerns about the installation of this equipment, contact the Harris Technical Assistance Center (TAC) using the following telephone numbers or e-mail address:

- U.S. and Canada: 1-800-528-7711 (toll free)
- International: 1-434-385-2400
- Fax: 1-434-455-6712
- E-mail: PSPC_InternationalCustomerFocus@harris.com

4 UNPACKING AND CHECKING THE EQUIPMENT

4.1 GENERAL INFORMATION

Required installation materials include those listed in this section. Verify all listed materials are present before beginning the installation.



CAUTION

After removal from the carton, examine all mobile radio components, the control head, and all other components for broken, damaged, loose or missing parts. If any are noted, contact the Customer Resource Center immediately (see page 19 for contact information) to discuss and arrange the return of the equipment to Harris for replacement. Any unauthorized attempts to repair or modify this equipment will void the warranty and could create a safety hazard.

Upon removing items from the carton and verifying that all equipment is accounted for, proceed with the installation.

4.2 MOBILE RADIO, CONTROL HEAD AND MICROPHONE

- VHF Trunk-Mount M7300 Mobile Radio, part number RU-144750-041**
(Catalog number MAMW-SHMXX)



or

- 800 MHz Trunk-Mount M5300/M7300 Mobile Radio, part number RU-144750-061**
(M5300 catalog numbers MAHK-S8MTX, MAHK-S8MEX and MAHK-S8MXX)
(M7300 catalog numbers MAMW-SDMXA, MAMW-SDMXE and MAMW-SDMXX)



- CH-721 Scan Control Head, part number CU23218-0002**
(M5300 catalog number MAHK-NCP9E)
(M7300 catalog number MAMW-NCP9E)



or

- CH-721 System Control Head, part number CU23218-0004**
(M5300 catalog number MAHK-NCP9F)
(M7300 catalog number MAMW-NCP9F)



- Standard Microphone, part number MC-101616-041**
(Included with catalog numbers MAHK-NMC7Z and MAMW-NMC7Z)



or

- DTMF Microphone, part number MC-103334-040**
(Included with catalog numbers MAHK-NMC9C and MAMW-NMC9C)



or

- Noise-Canceling Microphone, part number MC-103334-050**
(Included with catalog numbers MAHK-NMC9D and MAMW-NMC9D)



4.3 INSTALLATION KITS

Four (4) Motorcycle Installation Kits are available for M5300 and M7300 motorcycle radio installations. Two (2) are for M5300 motorcycle radio installations, and two (2) are for M7300 motorcycle radio installations. The kits are listed in the following table:

**Table 4-1: Motorcycle Installation Kits
for M5300/M7300 Mobile Radios with CH-721 Control Heads**

CATALOG NUMBER	DESCRIPTION
MAHK-NZN7X	M5300 Motorcycle Installation Kit with Accessory Cable
MAHK-NZN7Y	M5300 Motorcycle Installation Kit without Accessory Cable
MAMW-NZN7X	M7300 Motorcycle Installation Kit with Accessory Cable
MAMW-NZN7Y	M7300 Motorcycle Installation Kit without Accessory Cable

Table 4-2 below lists the contents of these installation kits. Contents are identical except MAHK-NZN7X for the M5300 radio and MAMW-NZN7X for the M7300 radio both include Accessory Cable 19B802554P24, whereas the other two kits do not contain this cable. Accessory Cable 19B802554P24 is required when making headset and/or portable radio connections as described in Section 11 of this manual.

Table 4-4 on page 25 lists part numbers for radio-related options and accessories, and Table 4-5 on page 26 lists options and accessories available for the CH-721 Scan and System model control heads.

Table 4-2: Contents of M5300/M7300 Motorcycle Installation Kits

ITEM	QTY.	PART NUMBER	DESCRIPTION	ILLUSTRATION
1	1 <input type="checkbox"/>	188D6464P1	Case, Weather-Resistant Motorcycle Radio, Black, Lockable (supplied with key)	
2	1 <input type="checkbox"/>	188D6437P1	Bracket, Case/Antenna	
3	1 <input type="checkbox"/>	188D6438P1	Bracket, Adapter	
4	1 <input type="checkbox"/>	KT23117	Kit, Remote-Mount Radio Mounting Bracket	
5	1 <input type="checkbox"/>	350A1396G1	Kit, Hardware, for Motorcycle Radio Case	

Table 4-2: Contents of M5300/M7300 Motorcycle Installation Kits (Cont.)







ITEM	QTY.	PART NUMBER	DESCRIPTION	ILLUSTRATION
6	1 <input type="checkbox"/>	350A1396G2	Kit, Hardware, for Motorcycle Radio Case, Brackets, and Antenna.	
7	1 <input type="checkbox"/>	350A1396G4	Kit, Hardware, Motorcycle Adapter Bracket Mounting (4 shock mounts).	
8	1 <input type="checkbox"/>	KT-008608	Kit, CH-721 Mounting Bracket. Includes (1) U-Shaped Mounting Bracket FM24841-0001, (2) ¼-Inch #8-32 stainless-steel screws, (2) stainless-steel flat washers and (2) stainless-steel lockwashers.	
9	1 <input type="checkbox"/>	CA-012365-001	Cable, M7200/M7300/M5300 DC Power. Includes (1) 20-Foot DC Power Cable with straight connector, (2) waterproof inline HFB-type fuse holders, (1) 3-amp AGC fuse, (1) 15-amp AGC fuse, and (1) 20-amp AGC fuse.	
10	1 <input type="checkbox"/>	CA-012616-001	Cable, CH-721 DC Power. Includes (1) DC Power Cable with straight connector, (2) waterproof inline HFB-type fuse holders, (1) 3-amp AGC fuse, and (1) 5-amp AGC fuse. This DC Power Cable has a 10-foot 12-AWG red wire (main power input), a 20-foot white wire (switched power input), and a 5-foot black wire (ground).	
11	1 <input type="checkbox"/>	19A703965P2	Filter, Alternator Whine Reject.	
12	6 <input type="checkbox"/>	2-320568-2	Terminal, Ring, 12 to 10 AWG, Insulated.	

Table 4-2: Contents of M5300/M7300 Motorcycle Installation Kits



ITEM	QTY.	PART NUMBER	DESCRIPTION	ILLUSTRATION
13	1 <input type="checkbox"/>	CA-009562-030	Cable, CAN; 30 feet, Right-Angle and Straight Connectors	
14	2 <input type="checkbox"/>	CD-014027-001	Terminator, CAN; 3-Pin	
15	1 <input type="checkbox"/>	LS102824V10	Speaker, External Mobile; 20-Watt (with 4.6-foot cable)	
16	1 <input type="checkbox"/>	MAMROS0034-NN006	Cable, Speaker; 6-Inch, Straight Connector	
17	1 <input type="checkbox"/>	FM-104859-001	Cap, Waterproof (For CH-721's DB-9 serial port connector)	
18	1 <input type="checkbox"/>	FM-104859-002	Cap, Waterproof (For CH-721's DB-25 accessory connector)	
20	1 <input type="checkbox"/>	188D6556G1	Hanger, Microphone	
21	1 <input type="checkbox"/>	CA-012349-002	Cable, Headset Adapter (Required when Accessory Cable 19B802554P24 is used. For additional information, see the NOTE that follows and Section 11.)	

In addition to the items listed in Table 4-2, Motorcycle Installation Kit MAHK-NZN7X for the M5300 radio and Motorcycle Installation Kit MAMW-NZN7X for the M7300 radio also include Accessory Cable 19B802554P24 (image shown below). When used with the M5300 and M7300 mobile radios, this cable provides connections for a headset and/or portable radio; see Section 11 for additional information. In other applications, it also supports connections to an external siren and light system:



4.4 ANTENNAS

Table 4-3: Antennas for Motorcycle Applications of the M5300 and M7300 Mobile Radios

PART NUMBER	DESCRIPTION	ILLUSTRATION
LE-OM150K.125/TNC	Antenna, 136 to 174 MHz High-Impedance Voltage/End-Fed; 2.5 dBd Gain	
LE-OM806HDBKTNCD	Antenna, 800 MHz High-Impedance Voltage/End-Fed	

4.5 OPTIONS AND ACCESSORIES

Table 4-4: Additional Options and Accessories for M5300 and M7300 Mobile Radios



PART NUMBER	DESCRIPTION	ILLUSTRATION
CA-012349-001	Cable, M5300/M7300 Option. See Section 13.1 (page 60)	
CA-013671-010 (10 feet long) or CA-013671-020 (20 feet long)	Cable, TIA/EIA/RS-232 Serial Programming (See page 63 for additional information.)	

Table 4-4: Additional Options and Accessories for M5300 and M7300 Mobile Radios

PART NUMBER	DESCRIPTION	ILLUSTRATION
CN-014756	Connector, RF; TNC Male Crimp-Type for RG58U, RG58A/U and RGU400 Coaxial Cable	

Table 4-5: Options and Accessories for CH-721 Control Heads

PART NUMBER	DESCRIPTION
CA-009562-006	Cable, CAN; 6 feet, Right-Angle and Straight Connectors
CA-011854-001	Cable, CH-721 Option
CA-104861	Cable, CH-721 Programming
MAMROS0075-N1210	Cable, DC Power; 12-AWG, 10-Foot, Straight Connector
MAMROS0075-R1210	Cable, DC Power; 12-AWG, 10-Foot, Right-Angle Connector
MACDOS0012	Kit, Control Head Pedestal Mounting. Includes Pedestal Mount and Mounting Screws.
MACDOS0013-CN004	Kit, Speaker; 20-Watt. Includes 6-Inch Cable MAMROS0034-NN006 (Straight Connector)
MC-101616-040 (Discontinued; replaced by MC-101616-041)	Microphone, Standard with Conxall Flush-Mount 45-Degree Connector
MC-101616-041	Microphone, Standard with Conxall Flush-Mount 90-Degree Connector (Included with catalog numbers MAHK-NMC7Z and MAMW-NMC7Z)
MC-103334-040	Microphone, DTMF with Conxall Flush-Mount 45-Degree Connector (Included with catalog number MAHK-NMC9C and MAMW-NMC9C)
MC-103334-041 (See footnote ⁵)	Microphone, DTMF with Conxall Flush-Mount 90-Degree Connector
MC-103334-050	Microphone, Noise-Canceling with Conxall Flush-Mount 45-Degree Connector (Included with catalog numbers MAHK-NMC9D and MAMW-NMC9D)
MC-103334-051 (See footnote ⁵)	Microphone, Noise-Canceling with Conxall Flush-Mount 90-Degree Connector
344A4678P1	Microphone Hanger (One included with each microphone catalog option)

⁵ As of the publication of this manual, microphones MC-103334-041 and MC-103334-051 are not available. These two mics have 90-degree connectors (also called “straight connectors”). See Section 3.3 for additional information.

Table 4-6: Headset-Related Options for Use with M5300 and M7300 Mobile Radios

CATALOG NUMBER	DESCRIPTION
SM-KA-13	Kit, Helmet Headset, External-Mount with One Speaker and Noise-Canceling Microphone
SM-KA-23	Kit, Helmet Headset, External-Mount with Two Speakers and Noise-Canceling Microphone
SM-KA11-FG	Kit, Half-Helmet Headset, Seer 1608, with One Speaker and Noise-Canceling Microphone
SM-KA21-FG	Kit, Half-Helmet Headset, Seer 1608, with Two Speakers and Noise-Canceling Microphone
SM-MCK-71GT	Cable, Headset Helmet Kit Interface, with Pushbutton PTT Switch (Kawasaki®)
SM-MCK-72GT	Cable, Headset Helmet Kit Interface, with Rocker PTT Switch and Channel Guard Disable Switch (Kawasaki)
SM-MCH-71GT	Cable, Headset Helmet Kit Interface, with Pushbutton PTT Switch (Harley-Davidson®)
SM-MCH-72GT	Cable, Headset Helmet Kit Interface, with Rocker PTT Switch and Channel Guard Disable Switch (Harley-Davidson)
SM-MCH-73GT	Cable, Headset Helmet Kit Interface, with Rocker/PTT/PA Switch and Channel Guard Disable Switch (Harley-Davidson)
SM-25-0694	Cable, Extender, Helmet to Harness
SM-CA-3G5	Assembly, Belt Box Cable, JAGUAR™ 700P/Pi and P7100 ^{IP}
SM-CA-3GY	Assembly, Belt Box Cable, LPE-200™
SM-CA-3GV	Assembly, Belt Box Cable, M-RK™
CA-012349-002	Cable, Headset Adapter
19B802554P24	Cable, Accessory

4.6 MATERIALS NOT SUPPLIED

The following is a non-inclusive list of typical materials that are not supplied with a standard radio equipment package, but will be required to complete the radio installation:

- Motorcycle’s Radio Bracket (sometimes referred to as an “Interface Bracket”) — Typical type shown in Figure 5-2.
- Control Head’s Adapter Bracket — See Figure 8-4
- Miscellaneous Hardware for Securing Brackets to Motorcycle
- Nylon Wire/Cable Ties

5 PLANNING THE INSTALLATION

5.1 GENERAL INFORMATION

Figure 5-1 on page 29 illustrates a typical M5300/M7300 mobile radio motorcycle installation. Before starting, plan the installation carefully so it will:

- Be safe for the motorcycle operator;
- Allow convenient access by the operator, as applicable (i.e., the control head);
- Neat; and,
- Allow easy service access.



A professional radio installer should perform the installation!



Mounting of the mobile radio components in ways other than those described in this manual may adversely affect performance, violate FCC rules on RF exposure, and even damage the unit(s), posing a potential safety hazard.

5.2 RECOMMENDED TOOLS

The following tools are recommended to complete the installation. Where specific vendor names and model or part numbers are presented, equivalent substitutes may be used:

- Non-Insulated Crimp Tool with Wire Cutter similar to Thomas & Betts WT-111-M
- Insulated Terminal Crimp Tool with Wire Cutter similar to Klein 1005
- Fuse Holder Crimp Tool similar to Thomas & Betts – WT-112M or California Terminal Products No. 1250 or Channelock No. 909
- Ratcheting Hex-Crimp Tool for 50-Ohm TNC and BNC RF Connectors and RG-58 Cable similar to Tyco Electronics 58433-2 (includes Crimper 354940-1 and Die Set 58436-1) or Cambridge 24-9960P
- Metric and S.A.E. Socket Set with Sockets to at least ½-Inch, a Nut Driver and an Extension at least 3-Inches Long
- Soft-Jaw Pliers similar to TESCO 450520 or equivalent
- Torx Screwdrivers, T10 and T20
- Phillips-Head Screwdrivers, #1 and #2
- Flat-Blade Screwdrivers, #1 and #2
- 4-Millimeter Hex Key Wrench
- ⅛-Inch Hex Key Wrench (Allen Wrench)
- Cordless Electric Drill(s) with Bits
- Deburring Tool (for ⅜-inch and smaller holes)
- Tie Wraps: 6-inches or larger
- Flush-Cut and Large Wire Cutters
- Various Fasteners (e.g., machine screws and nuts, Tek screws, etc.)



A separate list of test equipment is included in Section 15.2 on page 70.

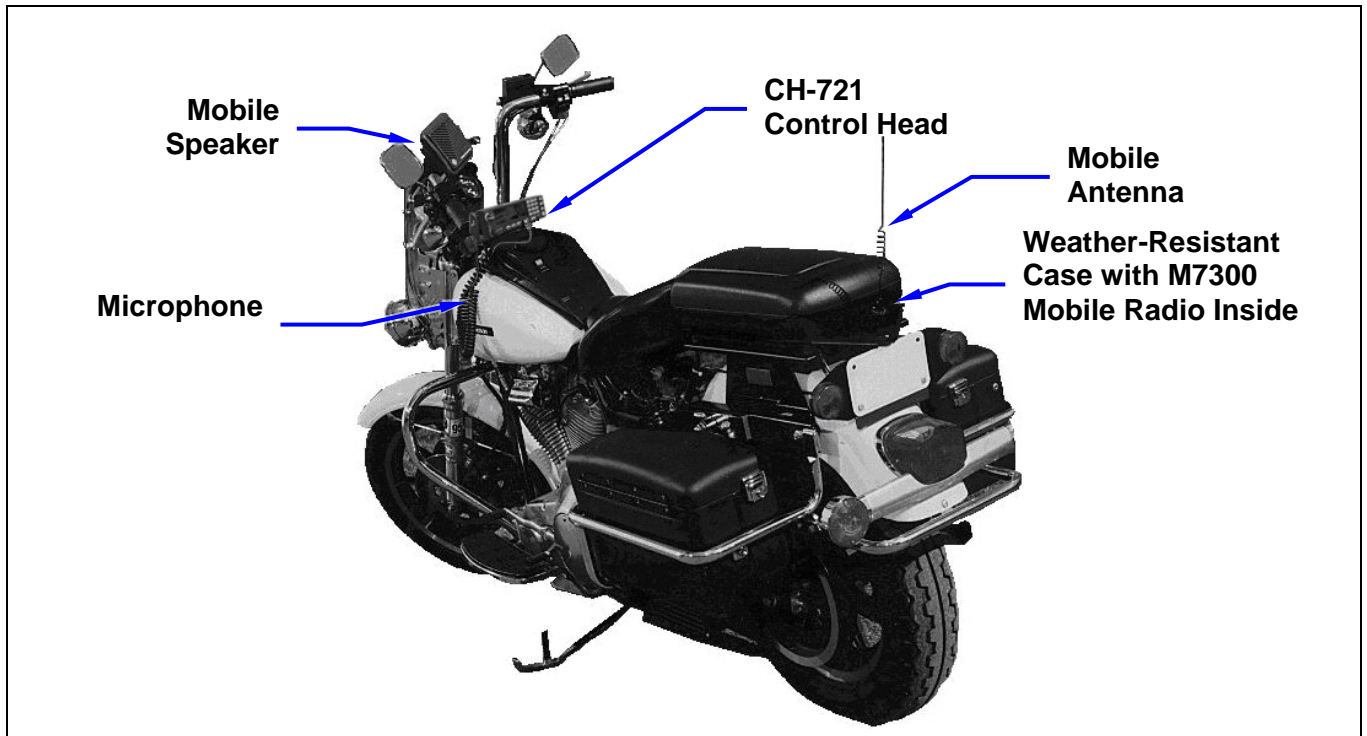

Figure 5-1: Typical Motorcycle Installation (Full View from Rear)

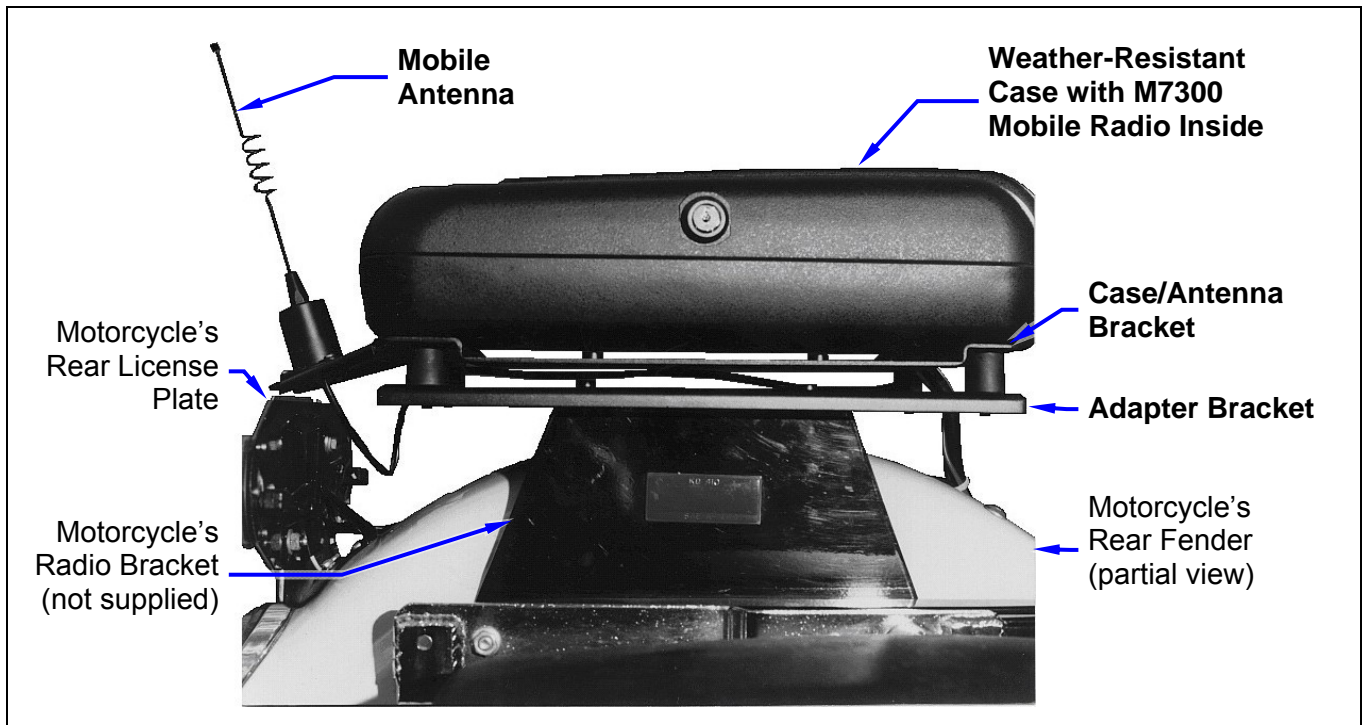

Figure 5-2: Typical Motorcycle Installation (Partial View of Radio Case and Brackets from Right Side)

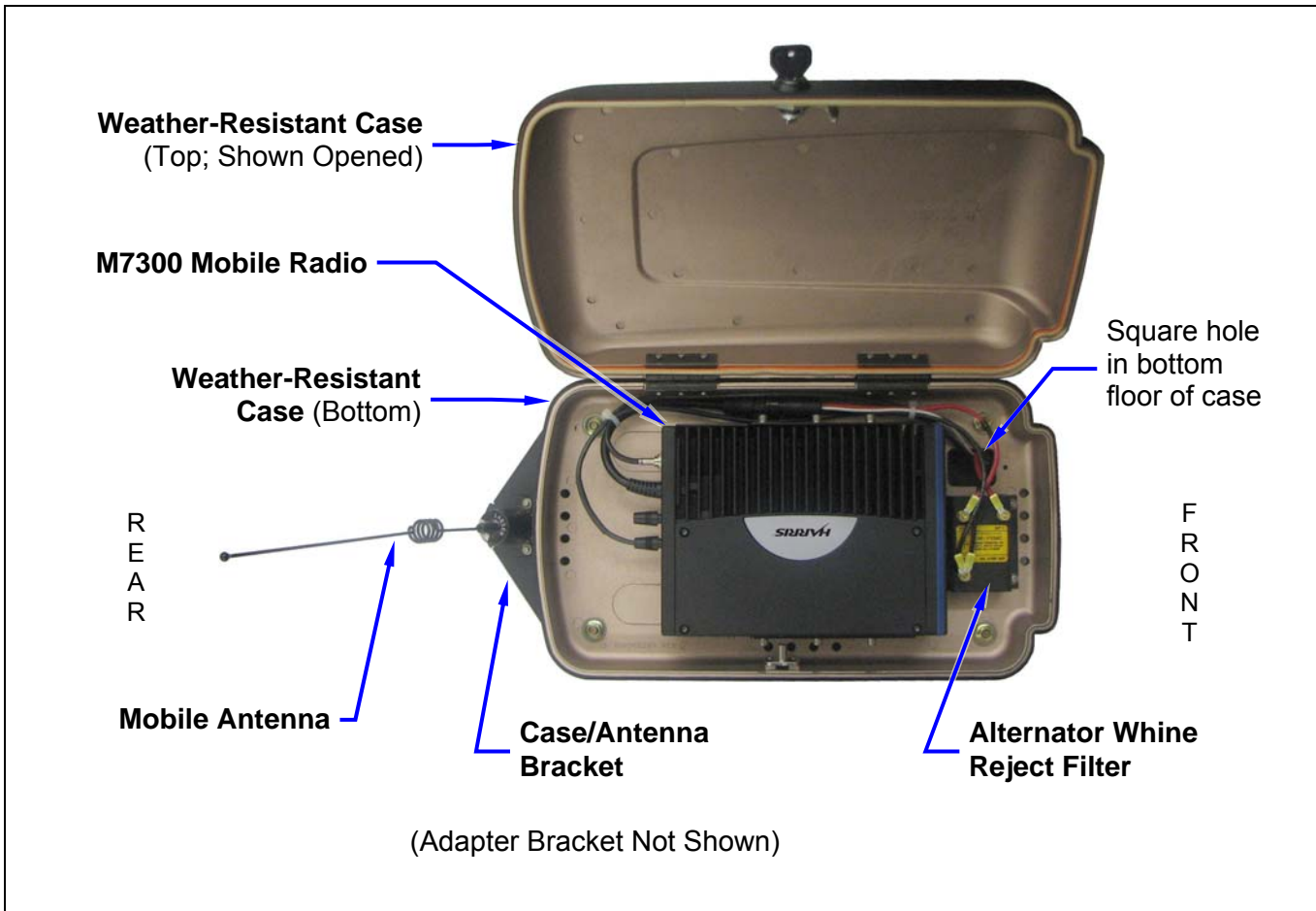

Figure 5-3: M5300/M7300 Mobile Radio inside Weather-Resistant Motorcycle Radio Case

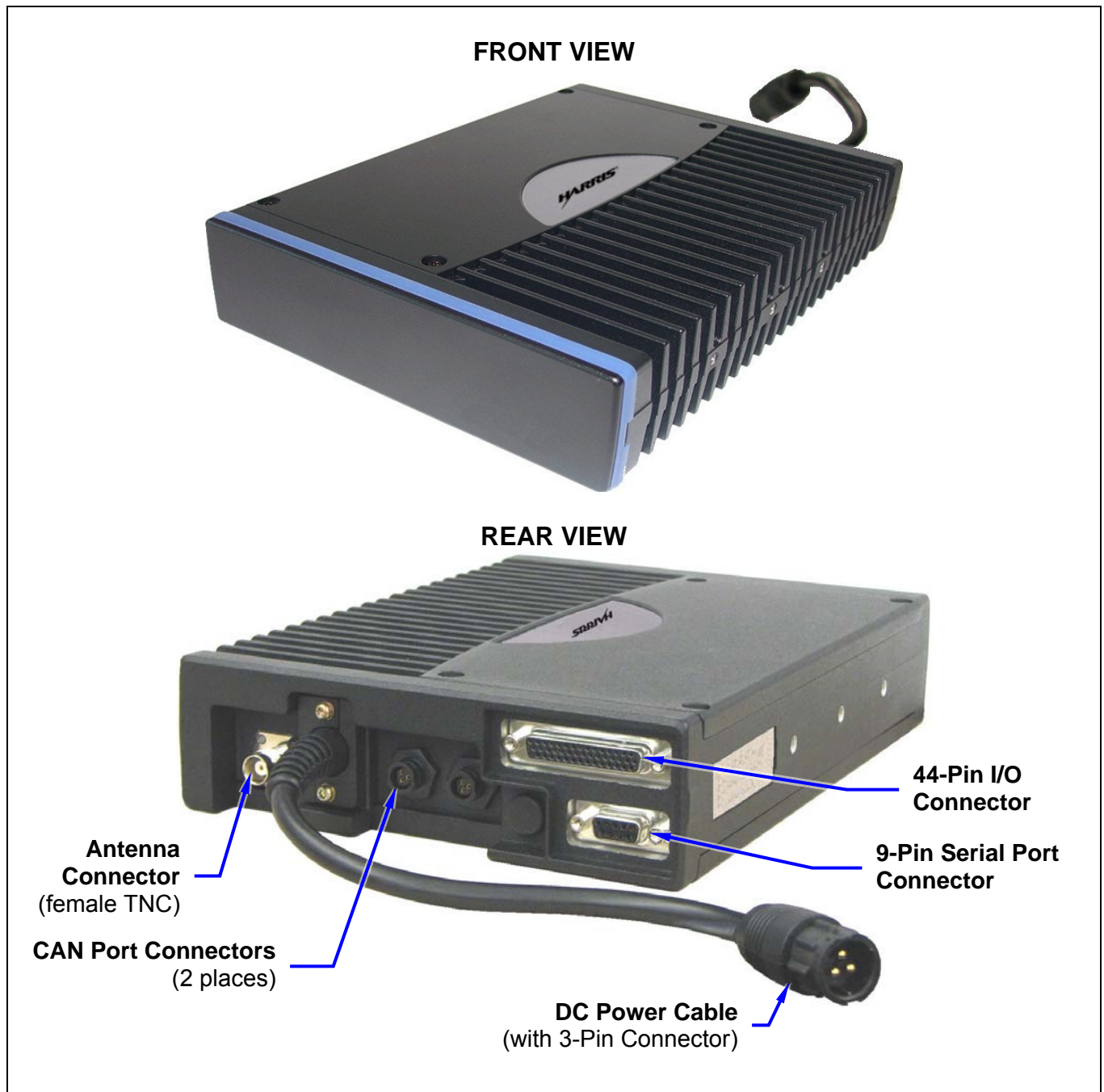

Figure 5-4: M5300/M7300 Mobile Radio — Front and Rear Views (Radio Removed from Case)

5.3 LOCATING COMPONENTS

Plan the mounting locations of all components (radio, control head, antenna, and cables) and determine the routes for all wiring and cables. Particularly consider the connection of the radio for planning purposes.

- The radio and its weather-resistant case must be mounted at the rear of the motorcycle, just above the rear fender. The respective installation procedures are contained in Section 6 of this manual.

- The mobile antenna must be mounted at the rear of the motorcycle on the supplied case/antenna bracket. For specific antenna installation-related information, refer to Section 7 of this manual.
- The CH-721 control head must be mounted at the front of the motorcycle, on the handlebars. The respective installation procedures are contained in Section 8 of this manual.
- Radio and control head dimensions are listed in Section 2.1 on page 12. Several inches of clearance space is required at the back of the control head.
- For other mobile radio related components such as the microphone and speaker, determine the customer's preferences if any, for mounting locations. Comply with these preferences as long as they are consistent with safety recommendations and guidelines presented in this manual, and other generally accepted professional radio installation practices.
- Verify the drilling of holes and the insertion of screws will not damage or interfere with any existing vehicle components (for example, a fuel tank, fuel lines, the transmission housing, etc.), or any existing vehicle wiring.



The radio must be kept out of direct sunlight and away from heat sources. Adequate free-air ventilation must be provided to its rear fins. The radio will automatically reduce its transmit RF output power when its ambient temperature exceeds approximately +140° Fahrenheit (+60° Celsius).



All cables should have a service loop near each connector end. Do not bend the cables at severe angles near the connector end. Above all, after all components are installed, verify no cable is under any tension. Failure to do so may lead to damaged cables, causing intermittent radio operation or complete radio failure.



Before drilling holes and/or installing mounting screws, verify these operations will not damage or interfere with any existing vehicle components such as the fuel tank, a fuel line, engine, transmission, wiring, etc. Always check to see how far the mounting screws will extend below the mounting surface prior to installation. Always deburr drilled holes before installing screws.

5.4 DC POWER CONSIDERATIONS

Careful consideration must be given to total direct current (DC) power drain on the motorcycle's electrical system (e.g., battery, alternator, wiring, etc.) The motorcycle may be equipped with additional lights, light flashers, siren, public address (PA) system, etc. that, in addition to the mobile radio, place additional drains on the system. Refer to Section 2 on page 12 for the applicable specifications.



Any DC input power provided to the radio shall be no higher or lower than 13.6 volts DC $\pm 10\%$. The DC input power should be free and clear of any AC noise or DC spikes above 18 volts. If the vehicle cannot meet these requirements, then DC conditioning will be required before any DC is connected to the radio. This includes conditioning for both the radio's main DC power input lead and for its switched ignition sense power input. DC conditioning can be accomplished by a noise filter or DC isolation equipment such as Harris part number FL-018314-001 or FL-018314-002, or similar units equal specifications. Contact TAC for additional information.

6 RADIO MECHANICAL INSTALLATION



Unless otherwise noted, all installation procedures in this manual should be performed in the order presented.

6.1 INSTALLING THE ADAPTER BRACKET

Install the Adapter Bracket by attaching it to the motorcycle's radio bracket as follows:

1. Obtain Adapter Bracket 188D6438P1 (Item 3 in Table 4-2) included in the Motorcycle Installation Kit.
2. Obtain the four (4) resilient mounts in Motorcycle Adapter Bracket Mounting Kit 350A1396G4 (Item 7 in Table 4-2).
3. As illustrated in Figure 6-1, attach a resilient mount to each corner of the bracket using four of the eight $\frac{5}{16}$ -inch serrated nuts included in Hardware Kit 350A1396G2 (Item 6 in Table 4-2). Use each mount's shortest stub. Tighten these four (4) nuts securely. A torque of approximately 100 in.-lbs. (11.3 N.m.) is recommended.



The Adapter Bracket's four (4) large PEM nuts must face up and its smaller PEM nut must face down. Also, the small PEM nut must be towards the left-rear of the motorcycle.

4. Using Figure 6-1 and/or Figure 6-2 as a guide, securely attach the Adapter Bracket to the motorcycle's radio bracket. Use the $\frac{1}{4}$ -20 x $\frac{5}{8}$ -inch-long bolts ("hex cap screws") and $\frac{1}{4}$ -inch flatwashers included in Hardware Kit 350A1396G2.

Some motorcycle radio brackets have pre-drilled holes that will match the four (4) PEM nuts in the Adapter Bracket. In this case, as illustrated in Figure 6-1, use a $\frac{1}{4}$ -inch flatwasher with each $\frac{1}{4}$ -20 bolt and first pass each bolt through the bracket hole, then into the respective PEM nut in the Adapter Bracket.

Other motorcycle radio brackets have pre-installed PEM nuts that match holes (without PEM nuts) in the Adapter Bracket. In this case, as illustrated in Figure 6-2, use $\frac{1}{4}$ -inch washers with each $\frac{1}{4}$ -20 bolt and first pass each bolt through the respective hole in the Adapter Bracket, then into the respective PEM nut in the motorcycle's radio bracket.

5. Tighten all four $\frac{1}{4}$ -inch bolts securely. A torque of between 55 and 60 in.-lbs. (6.2 to 6.8 N.m.) is recommended.

6.2 MOUNTING THE CASE AND CASE/ANTENNA BRACKET TO ADAPTER BRACKET

Mount the motorcycle radio case and the case/antenna bracket to the adapter bracket as follows:

1. Obtain Motorcycle Radio Case 188D6464P1 (Item 1 in Table 4-2) from the Motorcycle Installation Kit.
2. Obtain Case/Antenna Bracket 188D6437P1 (Item 2 in Table 4-2) from the Motorcycle Installation Kit.
3. Set the Case/Antenna Bracket onto the $\frac{5}{16}$ -inch studs of the four (4) resilient mounts. These mounts were attached to the Adapter Bracket in the previous procedure. Pass the studs through the oval-

shaped holes in the corners of the Case/Antenna Bracket. The bracket's triangle-shaped antenna mounting surface must face to the rear of the motorcycle.

4. Open-up the case to expose the interior floor in its bottom-half.
5. As illustrated in Figure 6-1, place the case over the Case/Antenna Bracket, and onto the $\frac{5}{16}$ -inch studs, passing the studs through the holes in the floor of the case. The square hole in the bottom floor of the case must be towards the front of the motorcycle, so it is directly over the square hole in the Case/Antenna Bracket.
6. Place a $\frac{5}{16}$ -inch stainless-steel flatwasher onto each of the four $\frac{5}{16}$ -inch studs protruding through the holes in the floor of the case. These flatwashers are included in Hardware Kit 350A1396G2 (Item 6 in Table 4-2).
7. Add four $\frac{5}{16}$ -inch serrated nuts to the studs (each nut's washer side down), and tighten all four nuts securely. A torque of approximately 100 in.-lbs. (11.3 N.m.) is recommended.

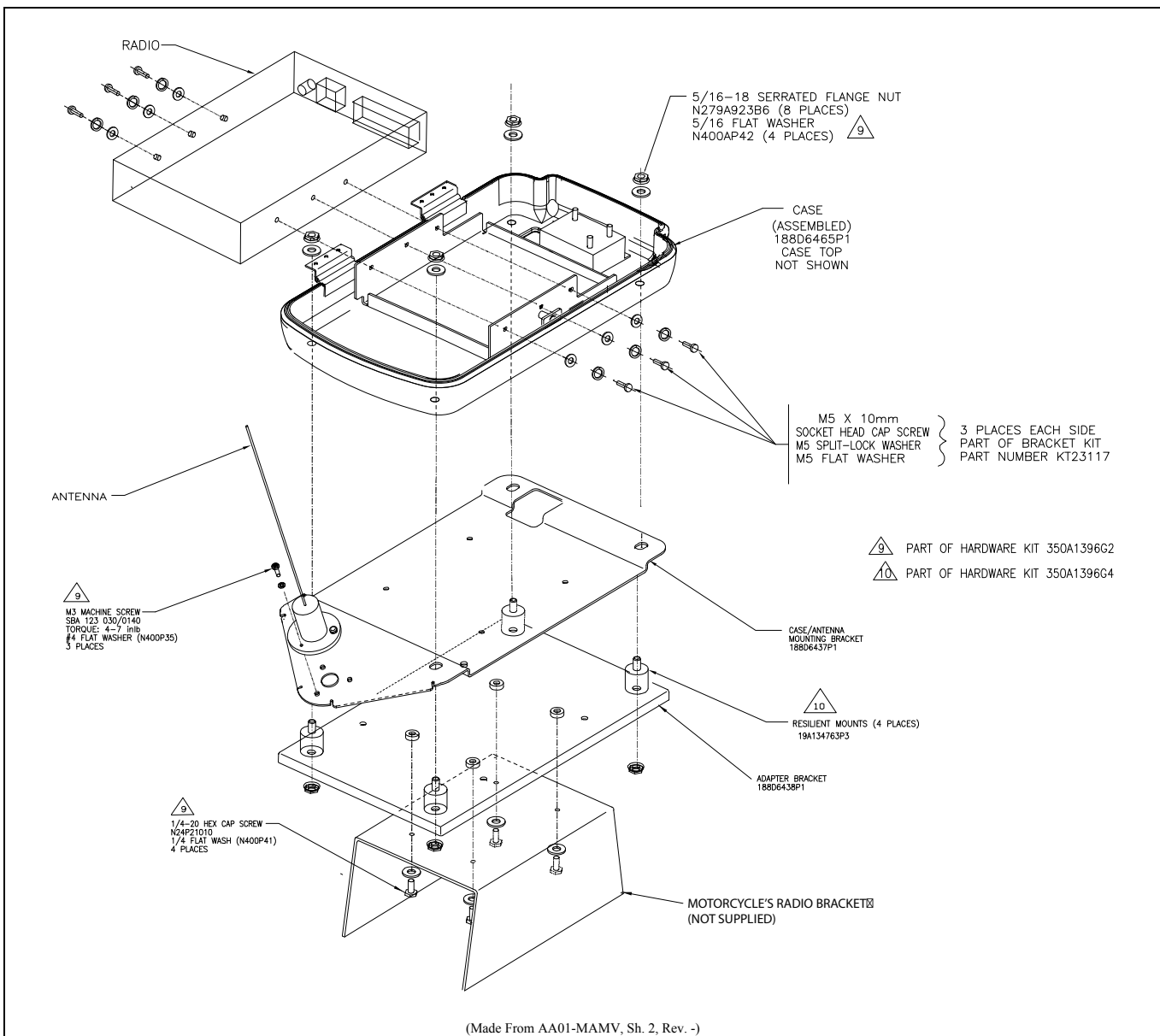

Figure 6-1: Assembling, Mounting and Installing the Radio Case and Brackets

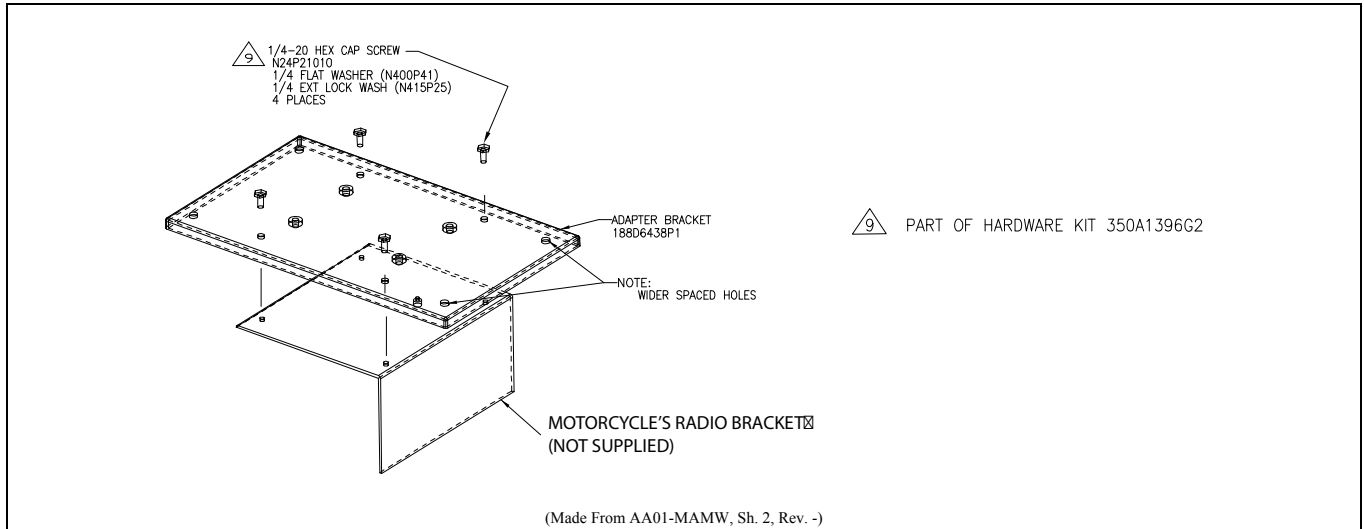

Figure 6-2: Alternate Mounting for Adapter Bracket

6.3 INSTALLING THE RADIO IN THE CASE

6.3.1 Install the Radio's Mounting Bracket

Install the radio's mounting bracket into the weather-resistant motorcycle radio using the following procedure. Also refer to Figure 6-3 as necessary:

1. Obtain Radio Mounting Bracket FM103111V1 from Remote-Mount Radio Mounting Bracket Kit KT23117 (Item 4 in Table 4-2).
2. If not already, open-up the case to expose the interior floor in the bottom-half of the case.
3. Position the bracket on the case's interior floor, at its mounting location. The large notches in the sides of the bracket must be positioned towards the front of the case. (Some early brackets did not have these notches.) The square hole in the floor is towards the front.
4. Secure the bracket to the case's floor using four M6 x 14 mm bolts and four external-tooth lockwashers included in Hardware Kit 350A1396G1 (Item 5 in Table 4-2).
5. Tighten these four bolts securely. A torque of between 45 and 65 in.-lbs. (5.1 to 7.3 N.m.) is recommended.

6.3.2 Install the Radio into Mounting Bracket

Install the radio into its mounting bracket as follows:

1. Lay the radio down into the mounting bracket with its front surface towards the front of the case. This positions the connectors on the rear panel of the radio towards the rear of the case and motorcycle. See Figure 5-3 and Figure 5-4 on pages 30 and 31.
2. Attach the radio to the bracket using the six (6) M5 x 10 mm stainless-steel socket-head screws, and flatwashers and lockwashers included with the Remote-Mount Radio Mounting Bracket Kit KT23117 (item 4 in Table 4-2). See Figure 6-1.
3. Tighten all six screws using a 4-millimeter hex key wrench until each lockwasher is fully compressed and the radio is firm and flush in between the brackets.

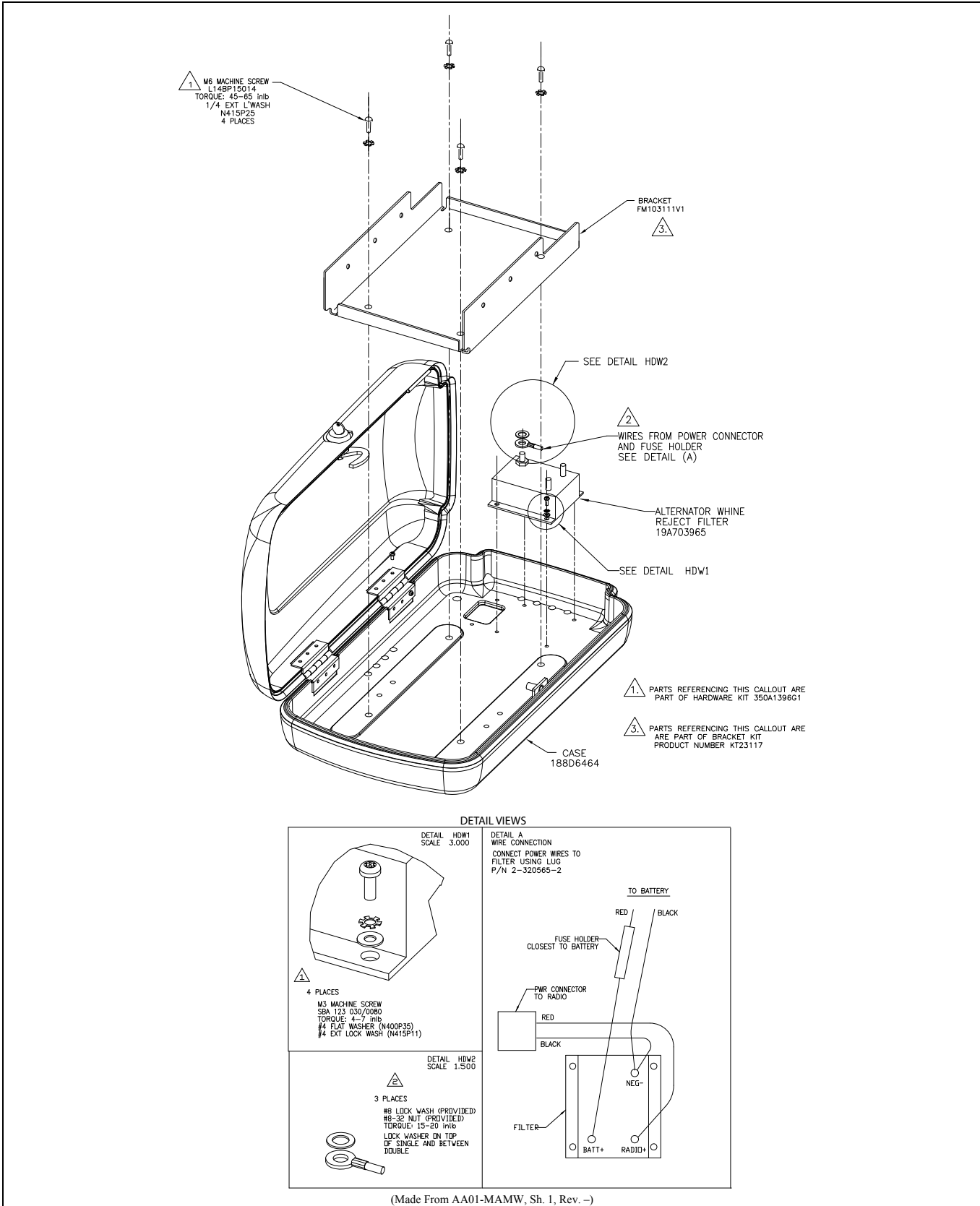

Figure 6-3: Installing the Radio's Mounting Bracket and Filter into the Motorcycle Radio Case

7 ANTENNA INSTALLATION

7.1 MOBILE ANTENNA INSTALLATION

7.1.1 Install the Mobile Antenna

Table 4-4 (page 25) lists the mobile antenna available for M5300 and M7300 mobile radio motorcycle installations. This antenna is a voltage/end-fed high-impedance antenna that provides the proper VSWR and radiation pattern without the use of a ground plane. Typical antenna gain without a ground plane is 0 dBd.

The following mobile antenna installation procedure is recommended:

1. Review the information presented in Section 1.2 (page 6), taking note of the Recommended Minimum Safe Lateral Distance for Controlled Environments presented in Table 1-1 (page 8).
2. Verify the antenna's mounting location on the triangular-shaped end of the Case/Antenna Bracket places the motorcycle operator outside of the Minimum Safe Lateral Distance for Controlled Environments. If it does not, the bracket(s) must be repositioned on the motorcycle. If necessary, contact the Technical Assistance Center. See page 19 for TAC contact information.
3. Mount the antenna in accordance with the instructions supplied with it.
4. Calculate the required antenna coax cable length using the information presented in the following section.



Since the antenna is a high-impedance, voltage/end-fed antenna, the length of the coaxial cable from the base of the antenna to the radio's TNC antenna connector is critical. It cannot be an arbitrary length. To prevent possible extraneous radiation, high VSWR, RFI feedback from the antenna to the radio, or antenna ground currents, select an antenna coaxial cable length that is close to a multiple of an odd quarter-wavelength. Refer to the following information for details on calculating the correct cable length.

7.1.2 Calculating the Antenna Cable Length

Typically, an antenna coax cable length of at least 32 inches will be required to reach from the base of the antenna to the TNC RF antenna connector at the rear of the radio. This length includes appropriately 6 inches for a service loop inside the case. To calculate the proper antenna coax cable length, proceed as follows:

1. Determine the center frequency of the majority of programmed transmit channel frequencies.
2. Use the following formula to calculate the ¼-wavelength, in inches:

$$\frac{1}{4}\lambda \text{ in inches} = \frac{2805}{\text{Frequency in MHz}}$$

Example: Assume the customer has a radio with all transmit frequencies between 816 and 821 MHz. Therefore, the center frequency is 818.5 MHz. Applying the above formula results in:

$$\frac{1}{4}\lambda \text{ in inches} = \frac{2805}{818.5} = 3.43 \text{ inches}$$

3. Calculate the ½-wavelength by multiplying the ¼-wavelength by 2:

Example: = 3.43 x 2 = 6.86 inches

- Pick a value of N then use the following formula to calculate an antenna cable length that will result in a cable length long enough for the installation:

$$(N \times \frac{1}{2}\lambda \text{ in inches} + \frac{1}{4}\lambda \text{ in inches}) \times 0.66 = \text{required cable length in inches}$$

Example: Choose N = 7. Therefore, the cable length in inches calculates to be:

$$(7 \times 6.86 \text{ inches} + 3.43 \text{ inches}) \times 0.66 = 33.96 \text{ inches}$$

- Verify the calculated cable length is long enough to route it from the base of the antenna, into the radio's weather-resistant case, to the TNC RF connector on the rear of the radio, leaving some cable length for a service loop. If not, recalculate the length per the formula in the previous step, using a greater value of N.
- Shorten the cable by cutting it to the calculated length.

7.1.3 Route Cable, Crimp-On TNC RF Connector and Connect It to the Radio

- Route the antenna coax cable from the base of the antenna to the radio's weather-resistant case.
- Route the cable into the case by passing it through the hole in the bottom of the case.
- Outside the case, tie and stow the cable.
- Using an appropriate crimp tool, crimp the supplied TNC RF connector to the end of the antenna cable. For crimping instructions, see Figure 7-1 or the instructions supplied with antenna.

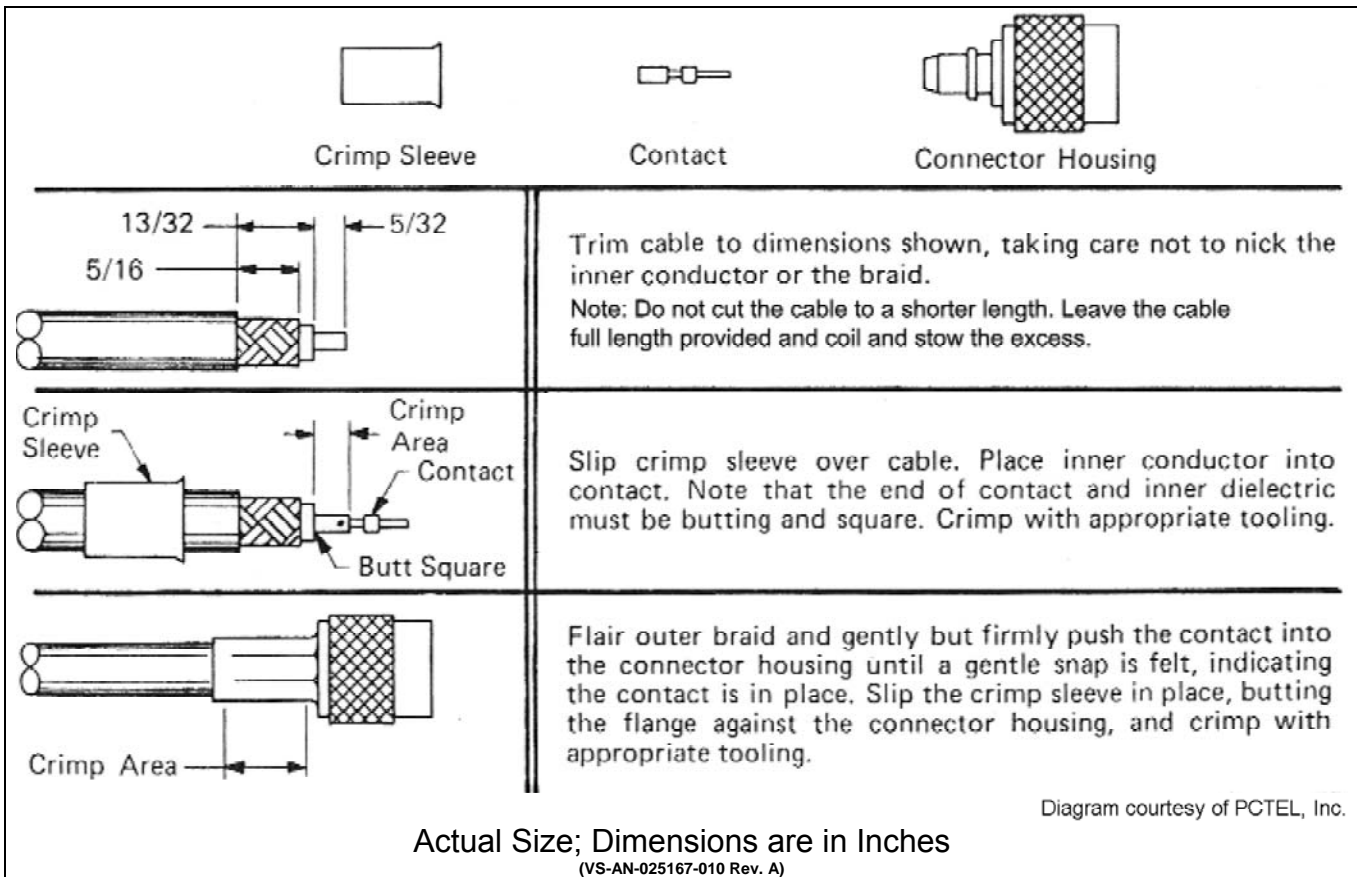

Figure 7-1: Crimping Instructions for TNC RF Connector

- The antenna cable is connected to the radio's TNC receptacle-type (female) RF connector per a procedure presented later in this manual. The cable and its TNC connector must be protected from

damage, dirt, and/or metal shavings which may be generated during the mechanical and electrical installation of the radio. Temporarily tying the connector and cable-end within a small plastic bag is recommended.

8 CONTROL HEAD MECHANICAL INSTALLATION

8.1 GENERAL INFORMATION

The radio must be connected to a control head to provide the operator-to-radio interface. Two different control heads are available — the CH-721 Scan model and the CH-721 System model. See Figure 8-1 and Figure 8-2 respectively. The CH-721 Scan model control head features three (3) large menu selection buttons. The System model control head has a 12-button keypad to allow advanced operations without the need of a DTMF-capable microphone.

Figure 8-3 on page 41 illustrates the rear panel of the two control head models. Both models have identical rear panels and rear panel connectors.

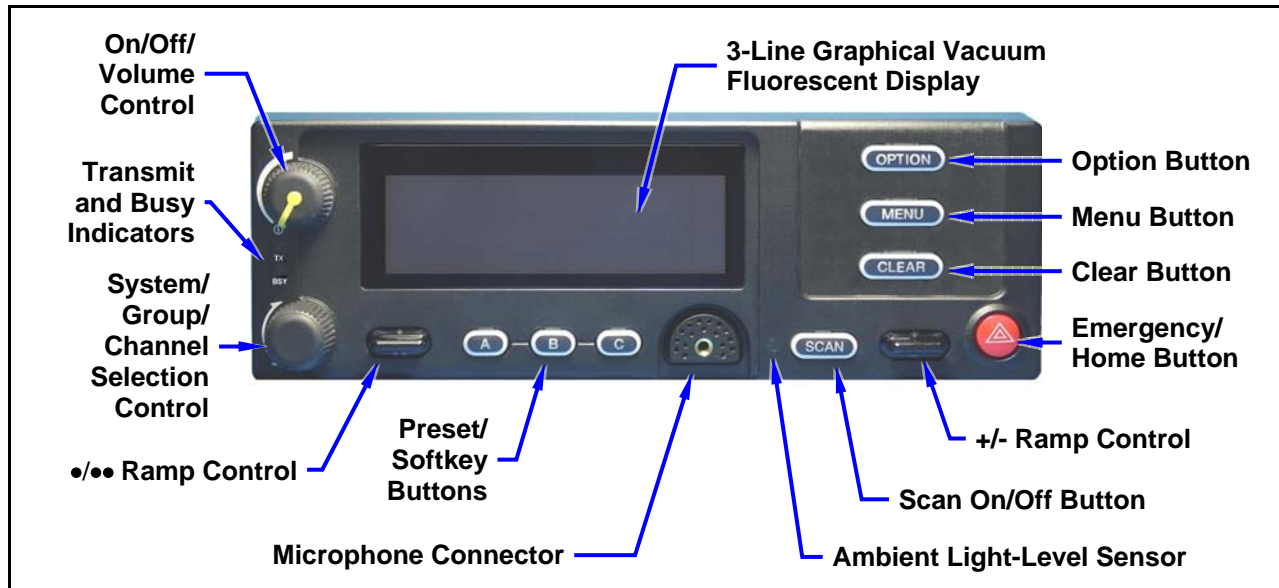

Figure 8-1: CH-721 Scan Model Control Head Front Panel

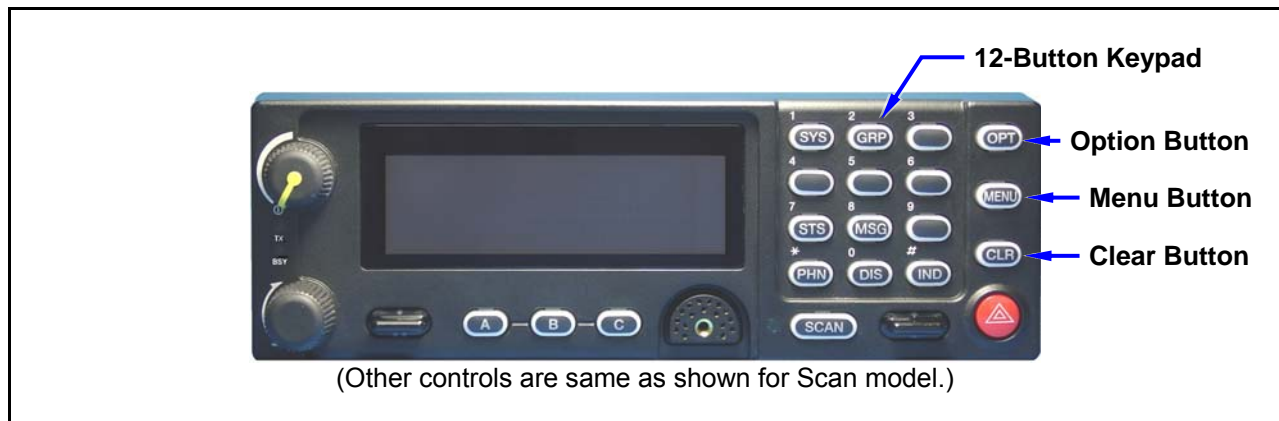

Figure 8-2: CH-721 System Model Control Head Front Panel

The CH-721 control heads feature a large easy-to-read 3-line graphical vacuum fluorescent display, an on/off/volume control knob, menu controls and buttons, trunking mode buttons, an emergency/home button, a scan on/off/volume control, and three (3) preset buttons. Other front panel components include a microphone connector and LED-type indicators. One LED indicator is the busy indicator that lights when

the radio is receiving a call and one is the transmitter-enabled indicator that lights when the radio is transmitting. The front panel also has an ambient light sensor for automatic display dimming.

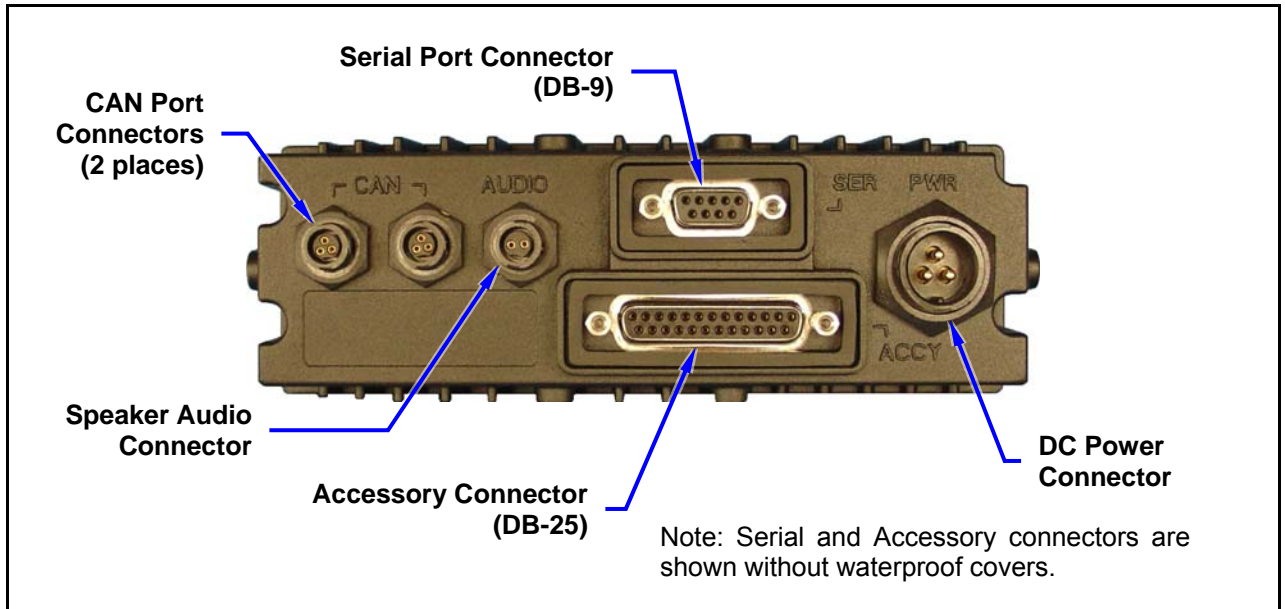

Figure 8-3: CH-721 Rear Panel (both control head models)



Prior to installing the control head, verify it has the proper software version installed and verify it has been properly configured for customer use.



Because an installation kit contains the most complete set of materials for installing the radio and control head, the following instructions make repeated reference to items within a kit. References to item numbers refer to items in a kit as listed in Table 4-2 on page 22.

8.2 MOUNTING THE CONTROL HEAD

8.2.1 Selecting a Mounting Location

Typically, the CH-721 control head is mounted at the centerline of the motorcycle between the steering handlebars, and secured to the handlebars or to the frame just below the handlebars. A typical installation is shown in Figure 8-4. The CH-721 control head can be mounted using either the standard U-shaped mounting bracket or the optional mounting pedestal. See Figure 8-4 and Figure 8-5 respectively. The selected mounting location must:

- Be safe for the motorcycle operator (e.g., the head must be located so it does not interfere with motorcycle steering or any other motorcycle controls);
- Allow convenient access by the operator;
- Be neat;
- Include clearance for the microphone’s connector that mates to the mic connector on the front of the head;
- Include clearance for the connectors/cables that mate to the connectors on the rear of the head; and,

- Have a relatively easy access for servicing.

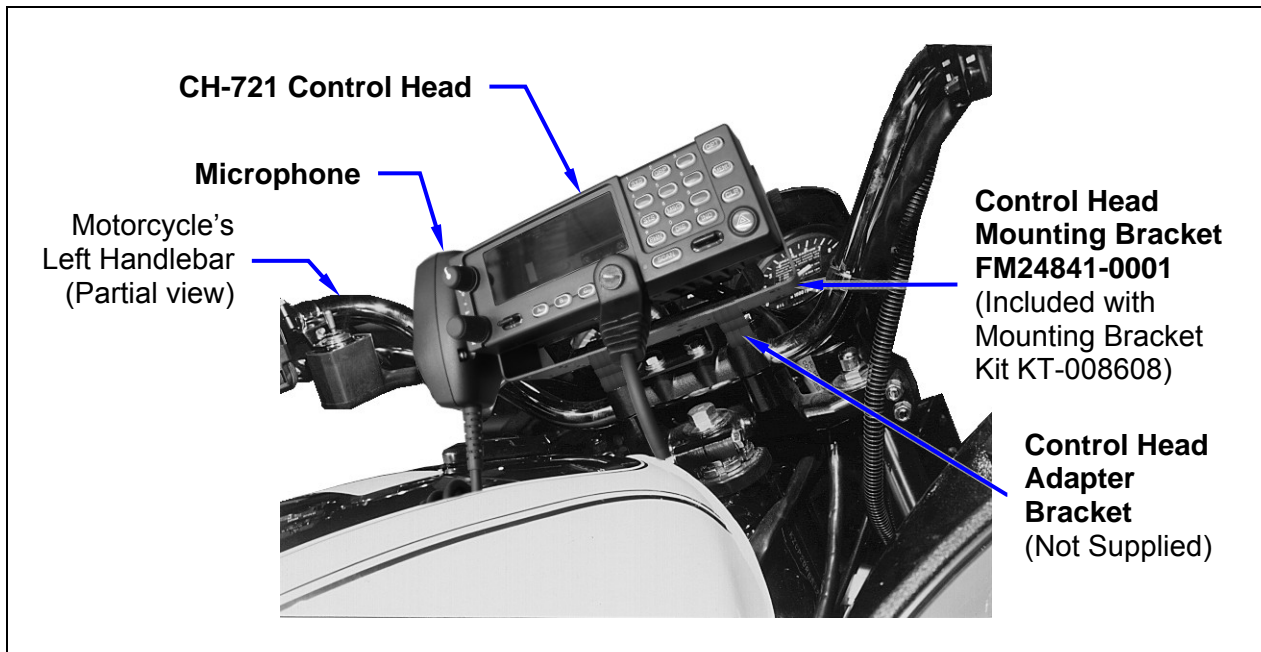

Figure 8-4: Typical CH-721 Control Head Installation on a Motorcycle (Using the Standard U-Shaped Mounting Bracket)

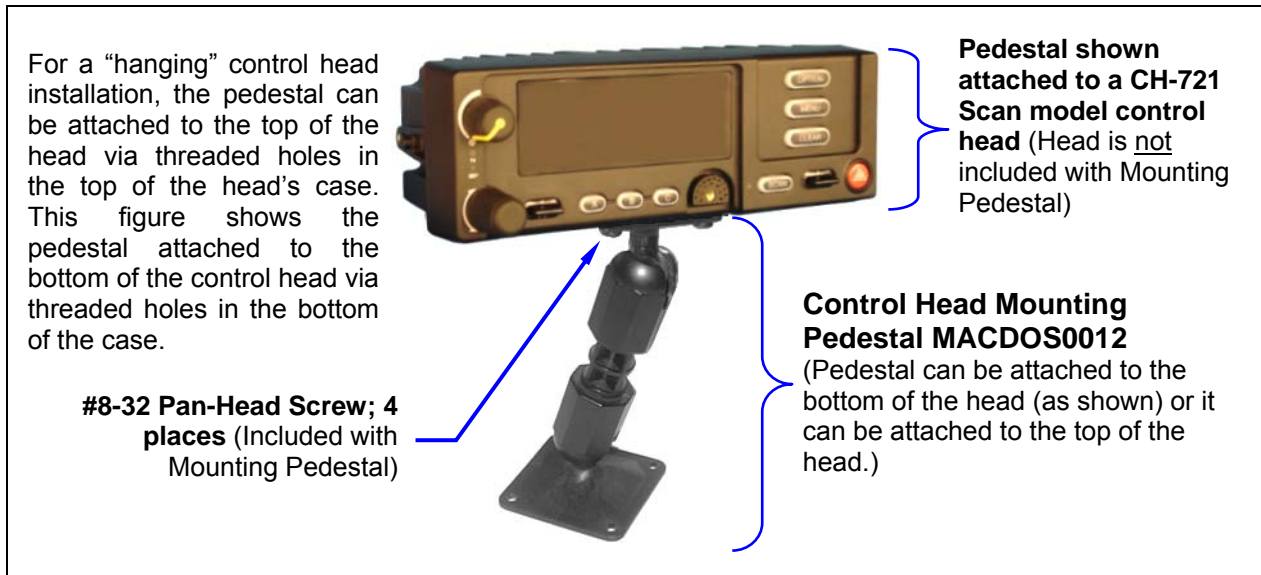

Figure 8-5: Optional Control Head Mounting Pedestal (Part Number MACDOS0012)

Due to the large number of different makes and models of motorcycles, it is the installer's responsibility to determine how to mount the control head and other related equipment such as the microphone hanger and speaker.

8.2.2 Control Head Adapter Bracket (Not Supplied)

In some cases, a control adapter bracket (not supplied) may be required to attach the supplied U-shaped control head mounting bracket (or the optional mounting pedestal) to the motorcycle. Control head adapter brackets for all makes and models are not available from the factory. Therefore, obtaining or field-fabricating an adapter bracket will be required in some cases. All utilized bracketry:

- Must be mounted in a location that is safe for the motorcycle operator (e.g., so it does not interfere with steering and other motorcycle controls);
- Must not interfere with the motorcycle operator’s visibility, including the view of all motorcycle instruments;
- Must provide a secure mount for the control head;
- Must utilize rounded corners/edges to the maximum extent possible; and,
- Must not be mounted in a way that compromises the strength of the motorcycle’s frame or other key components.



Never compromise the strength of a motorcycle’s frame, handlebars, or other key components by drilling or grinding holes in these components. Use clamps or another method approved by the motorcycle manufacturer to attach radio components.



Before drilling holes and/or installing mounting screws, verify these operations will not damage or interfere with any existing vehicle components such as the fuel tank, a fuel line, engine, transmission, wiring, etc. Always check to see how far the mounting screws will extend below the mounting surface prior to installation. Always deburr drilled holes before installing screws.

8.2.3 Mounting the CH-721 Control Head

8.2.3.1 Using the Standard U-Shaped Mounting Bracket

The following CH-721 control head mounting procedure is recommended:

1. Obtain CH-721 Mounting Bracket FM24841-0001 included in Mounting Bracket Kit KT-008608 (item 8 in Table 4-2).
2. Obtain or field-fabricate a suitable adapter bracket. Mount this bracket to the motorcycle according to the manufacture’s instructions and/or industry-standard practices. Observe and follow the requirements listed in Section 8.2.2.
3. Using the CH-721 Mounting Bracket as a template, mark and drill mounting holes into the adapter bracket as required. The round and elliptical holes in the mounting bracket’s mounting surface are symmetrical, so forwards/backwards positioning is not important during this step. However, positioning is important in the next step.
4. Position the mounting bracket on the surface of the adapter bracket so the two round holes in its two side “ears” are nearest to the normal location of the operator (towards the rear of the motorcycle) and the two slotted holes are farthest from the normal location of the operator.
5. Attach the mounting bracket to the adapter bracket using suitable mounting hardware (not supplied). The use of #12-24 stainless-steel self-locking hardware (i.e., machine screws with washers and self-locking nuts) is recommended, in at least six (6) locations.

6. Verify the mounting bracket is held firmly mounted. Firm mounting prevents unreasonable vibration, which could damage the control head and/or cause its cable connections to loosen.
7. Slide the control head into the bracket, placing the two pegs protruding from its left and right sides into the respective round holes in the bracket's two side "ears."
8. In each side "ear" of the mounting bracket, start a #8-32 hex-socket-head cap (Allen) head screw with a lockwasher and a flat washer by inserting the screw through the slotted hole in the bracket and then into the threaded hole in the side of the control head. This hardware is included with Mounting Bracket Kit. The lockwasher should be adjacent to the screw head and the flat washer should be adjacent to the bracket. Turn each screw clockwise as observed from the head of the screw.
9. The control head can be positioned at various angles for best display viewing at the normal position of the motorcycle operator. As necessary, turn it on the pegs to a good position and tighten both screws using an 1/8-inch hex key (Allen) wrench until the control head is held firmly in place. Do not over-tighten.

8.2.3.2 Using the Mounting Pedestal (Optional)

An optional Mounting Pedestal, part number MACDOS0012, may be purchased separately to replace the standard U-shaped mounting bracket. This pedestal can be attached to the bottom of the control head as shown in Figure 8-5, and then mounted to a mounting surface below the two. It can also be attached to the top of the head and then mounted to a mounting surface above the two.

9 SPEAKER INSTALLATION

9.1.1 Selecting a Mounting Location

Typically, the radio's speaker is mounted on the motorcycle's steering handlebars. The selected mounting location:

- Must be in a location that is safe for the motorcycle operator (e.g., so it does not interfere with steering and other motorcycle controls);
- Must not interfere with the motorcycle operator's visibility, including the view of all motorcycle instruments;
- Must allow for proper listening range with a moderate volume setting;
- Must be mounted securely; and,
- Must not be mounted in a way that compromises the strength of the motorcycle's frame or other key components.

9.1.2 Mounting the Speaker

The following mounting procedure is recommended:

1. Obtain External Speaker LS102824V10 (item 15 in Table 4-2) included in the installation kit.
2. Using the above listed guidelines, select a mounting location for the speaker.
3. Install the speaker using the hardware and mounting bracket supplied with it. In some case, an appropriate adapter bracket will be required (not supplied).
4. Route the speaker cable to the rear of the CH-721 control head.
5. Mate the 6-inch speaker cable (item 16 in Table 4-2) to the 2-pin connector at the rear of the control head by visually aligning the $\frac{3}{4}$ -moon-shaped keys of the connectors, and then pushing and turning the outer locking ring of the cable connector clockwise until it stops. A mild click will be sensed to confirm proper mating.
6. Connect the speaker cable's 2-pin plastic connector to the respective mating connector on the 6-inch speaker cable.
7. Route the cables out of the way of casual contact. Tie and stow as necessary.

10 CABLE CONNECTIONS

10.1 DC POWER CONNECTIONS

10.1.1 Overview of On/Off Power Wiring Configurations

Radio on/off power control is accomplished by the control head. In a standard installation, when the control head is turned on, it “wakes-up” the radio via data activity on the CAN link. The following power wiring configurations are supported:

- **Radio turns on and off automatically with vehicle’s ignition switch/key** — This configuration allows the on/off state of the vehicle’s ignition switch/key to control the on/off power state of the radio. The white wire of the control head’s DC Power Cable is connected to a fused switched power source, typically identified as vehicle “Accessory” power. This source must switch on (up to positive (+) battery voltage potential) when the vehicle’s ignition switch/key turns on, and it must switch off (to near zero volts) when the ignition switch/key turns off. The required fuse rating is 3 amperes. When using this configuration, the CH-721 control head’s on/off/volume control must be left in the on position for automatic power-up/down to function properly.



NOTE

A waterproof (HFB type) fuse holder and a 3-amp AGC fuse are included with the control head’s DC Power Cable to fuse this cable’s white wire.

- **Radio turns on and off with a manual switch** — This configuration is used when, for example, the radio must remain on even when the ignition key must be removed from the vehicle and a separate on/off switch is acceptable. The white wire of the control head’s DC Power Cable is connected to one side of a manually-controlled switch, and the other side of this switch is connected to unswitched and fused vehicle power. The required fuse rating is 3 amperes. When using this configuration, the CH-721 control head’s on/off/volume control must be left in the on position for automatic power-up/down to function properly.
- **Radio turns on with control head’s on/off/volume control (“hot wired”)** — This configuration allows radio on/off power control only via the control head’s on/off/volume control. It may be desired if, for example, the radio must remain on even when the ignition key must be removed from the vehicle and a separate on/off switch is not desired and/or not acceptable. The white wire of the control head’s DC Power Cable must be connected to unswitched and fused vehicle power. The required fuse rating is 3 amperes.

In all of the above cases, both the radio’s main DC power input (red wire) and the control head’s main DC power input (also a red wire) must be connected to unswitched vehicle DC power (12-volts nominal) via an Alternator Whine Reject Filter located in the motorcycle radio case. DC power supplied to this filter is over-current protected by a fuse installed near the DC power source (i.e., near the motorcycle’s positive battery terminal). The white ignition wire of the radio’s DC Power Cable is not used/not connected in motorcycle applications.

10.1.2 Alternator Whine Reject Filter Installation

Install the Alternator Whine Reject Filter in the weatherproof radio case as follows:

1. Obtain Alternator Whine Reject Filter 19A703965P2 from the installation kit.
2. Using a T10 Torx screwdriver, mount the filter to the inside bottom floor of the radio case using the four (4) stainless-steel M3 x 8-millimeter-long screws and M3 washers supplied in Hardware Kit

350A1396G1. As shown in Figure 5-3, position it so the two positive (+) studs are nearest the square hole in the floor, and the ground stud is furthest from the hole. Tighten the screws securely.



Any DC input power provided to the radio shall be no higher or lower than 13.6 volts DC $\pm 10\%$. The DC input power should be free and clear of any AC noise or DC spikes above 18 volts. If the vehicle cannot meet these requirements, then DC conditioning will be required before any DC is connected to the radio. This includes conditioning for both the radio's main DC power input lead and for its switched ignition sense power input. DC conditioning can be accomplished by a noise filter or DC isolation equipment such as Harris part number FL-018314-001 or FL-018314-002, or similar units equal specifications. Fusing must be placed in-line before any noise filter. Contact TAC for additional information.

10.1.3 DC Power Cable and Main Fuse Holder Installation

The radio's DC Power Cable has a 3-pin connector, a 20-foot red wire (for the main power connection), a 20-foot white wire (not connected), and a 4-foot black wire (for the ground connection). It is supplied with waterproof fuse holders, two AGC-type fuses, and ring terminals. The following installation procedures are recommended:

10.1.3.1 Black Wire Connection (Ground Wire)

1. Connect the radio's DC Power Cable to the radio by mating its 3-pin connector to the radio's 3-pin power cable connector as follows: Visually align the key and firmly push and turn the outer locking ring clockwise until it stops. A click will be sensed to confirm proper mating.



Do not confuse the radio's DC Power Cable which has a 10-AWG red wire with the control head's DC Power Cable which has a 12-AWG red wire. The radio requires much more DC operating current than the control head. Therefore, it requires the larger wire size of 10-AWG. **The part number of the radio's DC Power Cable is CA-012365-001.**

2. Cut the white wire approximately three (3) inches from the cable's connector, and insulate its end using an approved method.
3. Route the cable's black wire from the connector at the rear of the radio to the Alternator Whine Reject Filter near the square hole in the bottom floor of the radio case. Leaving a service loop at the rear of the radio, cut this wire to a length long enough to reach the ground stud on the filter. Save the excess-length black wire to make the ground connection near the battery.
4. Strip approximately ¼-inch of insulation from both the end of the black wire from the cable connector and one end of the excess-length black wire, then crimp a #8-stud ring terminal (has yellow insulation) to each stripped wire end. These ring terminals are included with the Motorcycle Installation Kit.
5. Remove the nut from filter's ground stud (stud labeled "NEG") and attach both ring terminals to this stud. Reinstall the nut. It is not necessary to tighten the nut at this time, since a control head ground wire will be added to this stud in a later procedure.
6. Route the excess-length black wire out of the square hole in the bottom floor of the radio case.
7. Prepare to connect this end of the black wire to vehicle ground by locating an area of metal within approximately two (2) feet of the radio, and drilling a hole in it if necessary. This surface **must** have a solid and stable connection to vehicle ground. If a new hole must be drilled, it should **not** be in a

structural part of the motorcycle's frame, which could weaken the frame and cause it to crack. If possible, use an existing hole to ground the black wire.

If an existing hole cannot be located, locate a non-structural metal area of the motorcycle that has a solid and stable ground connection to the motorcycle's frame. Drill a $\frac{3}{8}$ -inch hole in this metal area, deburr it, and strip this area of all paint and dirt to expose a bare metal surface, approximately $\frac{3}{4}$ -inch square. A $\frac{3}{8}$ -inch-stud non-insulated ring terminal is supplied with the cable to make this ground connection. Hole diameter must be appropriate for the utilized grounding screw/bolt size and type used to connect the ring terminal to the bare metal surface. This hardware is not supplied.



WARNING

Never compromise the strength of a motorcycle's frame, handlebars, or other key components by drilling or grinding holes in these components. Use clamps or another method approved by the motorcycle manufacturer to attach radio components.

8. Cut the excess-length black wire to the required length then strip insulation back approximately $\frac{1}{4}$ -inch.
9. Crimp a $\frac{3}{8}$ -inch non-insulated ring terminal (supplied with the cable) to the end of the black wire, crimp-on another terminal appropriate for the type of connection hardware being used.
10. Attach the ring terminal and black wire to the bare metal surface using stainless-steel self-locking hardware (i.e., machine screws with washers and locking nuts) or other appropriate hardware to ensure a reliable terminal-to-metal contact. Tighten securely.
11. Apply an approved paint or rust-inhibitor over the remaining exposed bare metal surface and around the ring terminal.

10.1.3.2 Red Wire and Main Fuse Holder Connection (Radio's Main Power Wire)

1. Route the cable's red wire from the connector at the rear of the radio to the Alternator Whine Reject Filter near the square hole in the bottom floor of the radio case. Leaving a service loop/slack at the rear of the radio, cut this wire to a length long enough to reach the DC output stud (stud labeled "RADIO +") on the filter. Save the excess-length red wire to make the battery connection.
2. Strip approximately $\frac{1}{4}$ -inch of insulation from both the end of the red wire from the cable connector and one end of the excess-length red wire, then crimp a #8-stud ring terminal (has yellow insulation) to each stripped wire end. These ring terminals are included with the installation kit.
3. Remove the nut from filter's DC output stud (stud labeled "RADIO +") and attach both ring terminals to this stud. Reinstall the nut. It is not necessary to tighten the nut at this time, since a control head power wire will be added to this stud in a later procedure.
4. Route the excess-length red wire out of the square hole in the bottom floor of the radio case.
5. Route the excess-length red wire to the location of the vehicle's battery (or its main DC bus bar or stud). Protect the wire from possible chafing where necessary. Tie and stow the wire as necessary.



CAUTION

Do **not** install any wiring or fuse holders over or in the near vicinity of the motorcycle's engine, or near other hot items such as exhaust pipes and mufflers. Excessive heat can cause permanent damage to these components.



Before making connections to the battery's positive post, carefully disconnect the battery's negative (ground) cable(s). This will prevent tools or other metallic objects which come in contact with the battery's positive terminal from shorting to vehicle ground, causing sparks or even a fire or an explosion! When disconnecting the negative cable(s), cover/insulate the positive post if it is not already so a tool cannot short between the posts.

Radio and control head fuses should not be installed until all wiring is complete. This will prevent the radio from powering up prematurely and/or causing an in-rush of current that could lead to shorting of the battery, sparks, or even fire.

6. Obtain one of the waterproof (HFB type) fuse holders included with the DC Power Cable.
7. **Observe and follow the previously presented WARNING!**
8. Cut the red wire to the required length for connection to the battery's positive (+) battery terminal (or to the main DC bus bar or stud).
9. Prepare to splice the waterproof fuse holder into the red wire by cutting it again, at approximately three (3) to six (6) inches from the end.
10. Strip all three (3) wire ends back approximately 3/8-inch, place a fuse holder shell on each wire, and securely crimp a fuse holder terminal to each wire end. Before crimping, verify fuse holder shells are oriented in the correct directions (i.e., with each large end towards the wire end).
11. Label this fuse holder and red wire appropriately (e.g., "Radio Main Power: 15-AMP FUSE").
12. **Do NOT install a fuse into the fuse holder at this time.**
13. Crimp an appropriate electrical terminal to the short red wire. A corrosion-resistant 3/8-inch ring terminal is included with the cable for this purpose, but another size corrosion-resistant terminal type (not supplied) may be used if required.
14. Connect the ring terminal directly to the battery's positive post (or if present, to a stud on the battery's main/non-switched power distribution terminal block).



When servicing the radio and/or control head, always manually power-down the radio equipment via the control head's on/off/volume control knob, and then remove the main power fuse near the battery.

10.1.4 **Control Head Power Cable Installation**

Plan the route of the control head's DC Power Cable carefully. Do not route the cable where it will be damaged by heat sources or by casual contact, and protect it from wire chafe per standard installation methods. The following procedures are recommended:

10.1.4.1 **Install DC Power Cable and Make Power and Ground Connections**

1. Connect the control head's DC Power Cable (item 10 in Table 4-2) to the large 3-pin connector at the rear of the head. Visually align the key and gently push and turn the outer locking ring clockwise until it stops. A click will be sensed to confirm proper mating.
2. Protect the wires of this cable by inserting them into an appropriate-length high-temperature tubing, loom or wrap (not supplied). Typically, a 4 to 5-foot length of tubing/loom/wrap is required.
3. Make a service loop in the cable near the back of the control head.

4. Route the cable (within the tubing/loom/wrap) to the frame of the motorcycle. If the control head is mounted on the motorcycle's handlebars, leave sufficient slack to allow for full handlebar steering/travel without any stretching of the cable. This length of the cable must be in tubing/loom/wrap. Tie and stow as necessary.
5. Route the cable to the radio case at the rear of the motorcycle and then pass it through the square hole in the bottom floor of the case.



Do **not** install any wiring or fuse holders over or in the near vicinity of the motorcycle's engine, or near other hot items such as exhaust pipes and mufflers. Excessive heat can cause permanent damage to these components.

6. Cut excess length from the red and black wires of the cable, leaving enough length for a service loop inside the radio case, near the Alternator Whine Reject Filter. The red and black wires connect to two (2) studs on the filter. The white wire is connected in the procedure that follows.
7. Strip approximately ¼-inch of insulation from the end of the black wire and crimp a #8-stud ring terminal (has yellow insulation) to it. Ring terminals are included with the installation kit
8. Remove the nut from the filter's ground stud (stud labeled "NEG") and slip the ring terminal with the black wire onto this stud. Three (3) black wires should be connected to this stud. Reinstall the nut and tighten it securely. Recommended torque is 12 inch-pounds (1.36 Nm). Do not over-tighten the stub nuts.
9. Strip approximately ¼-inch of insulation from the end of the red wire and crimp a #8-stud ring terminal (has yellow insulation) to it.
10. Obtain one of the waterproof (HFB-type) fuse holders included with the control head's DC Power Cable.
11. Prepare to splice this waterproof fuse holder into the red wire by cutting it again, approximately three (3) to six (6) inches from the end with the ring terminal.
12. Strip both wire ends back approximately ⅜-inch, place a fuse holder shell on each wire, and securely crimp a fuse holder terminal to each wire end. Before crimping, verify fuse holder shells are oriented in the correct directions (i.e., with each large end towards the wire end).
13. Remove the nut from the filter's DC output stud (stud labeled "RADIO +") and slip the red wire's ring terminal onto the stud. Three (3) red wires should be connected to this stud. Reinstall the nut and tighten it securely. Recommended torque is 12 inch-pounds (1.36 Nm). Do not over-tighten the stub nuts.
14. Obtain the 5-amp AGC-type fuse included with the cable, and install it into the fuse holder.
15. Label this fuse holder and red wire appropriately (e.g., "Control Head Main Power: 5-AMP FUSE").



The fuse for the control head's red wire is rated at 5 amperes. The 3-amp fuse included with the cable must **not** be used for fusing the control head's main DC power. It fuses the head's white wire.

10.1.4.2 Connect DC Power Cable's White Wire

A review of the information presented in Section 10.1.1 (page 46) may be beneficial at this time. As required per the chosen power-up configuration, connect the white wire by following one of the three procedures presented in the respective sub-section that follows.

10.1.4.2.1 Control Head and Radio Turn on with Vehicle's Ignition Switch/Key

With this wiring configuration, the control head and radio automatically turn on and off with the vehicle's ignition switch/key. The white wire of the control head's DC Power Cable is sometimes referred to as the "white ignition switch wire" or the "ignition sense input wire." In this configuration, the white wire connects to a switched power source, typically identified as "Accessory" power, that switches on and off with the vehicle's ignition switch/key. When using this configuration, the CH-721 control head's on/off/volume control must be left in the on position for automatic power-up/down to function properly.



NOTE

The white ignition sense wire must be connected to a fused power source that switches from approximately zero volts to approximately +13.6 volts when the vehicle's ignition switch/key is turned from the OFF position to the ACCESSORY and RUN positions. Use of a switched power source that is subject to voltage changes as a result of other actions may result in undesirable radio operation and/or a degradation of radio performance.

1. Locate the vehicle's switched ignition or "Accessory" power connection point that will be used for the switched ignition 12-volt DC power source. This point is typically located at or near the vehicle's fuse panel. Consult the motorcycle manufacturer's wiring diagram as necessary.
2. Route the white wire of the control head's DC Power Cable to the area near this connection point. Protect the wire from heat and chafing as necessary.
3. Obtain one of the waterproof (HFB-type) fuse holders included with the control head's DC Power Cable.
4. Cut excess length from the white wire and splice the fuse holder into it, near the location of the connection point.
5. Using an appropriate electrical terminal, connect the white wire to the switched power connection point. An open-barrel spade terminal is included with the cable for this purpose, but another type of terminal (not supplied) may be used as required.
6. Obtain the 3-amp AGC-type fuse included with the cable, and install it into the fuse holder.
7. Tie and stow all wiring as necessary so it remains out of the way of casual contact and wire chafe is avoided.

10.1.4.2.2 Control Head and Radio Turn On with a Manual Switch

With this wiring configuration, the control head and radio are manually turned on and off via an on/off switch mounted separately from the control head and radio, not through the vehicle's ignition switch/key. This configuration is used when, for example, the radio must remain on even when the ignition key must be removed from the vehicle and a separate on/off switch is acceptable and/or required. In this configuration, the white wire connects to a fused switched power source such as that provided by a toggle switch mounted on the vehicle's instrument panel. When using this configuration, the CH-721 control head's on/off/volume control must be left in the on position for automatic power-up/down to function properly.

1. Route the white wire of the control head's DC Power Cable to an area near the location of the panel-mounted on/off switch. Protect the wire from heat and chafing as necessary.
2. Cut a short section (6 to 8 inches) off the end of the white wire and strip the ends.
3. Obtain one of the waterproof (HFB-type) fuse holders included with the control head's DC Power Cable, and crimp one half of it to one end of the short section of wire.

4. Using an appropriate electrical terminal, connect this short white wire to unswitched 12-volt DC power source at or near the vehicle's fuse box.
5. Cut another section of white wire from the cable. This wire must be long enough to reach from this fuse holder to the location of the panel-mounted on/off switch.
6. Strip one end of this wire and crimp the other half of the waterproof fuse holder to this wire end.
7. Strip the other end of this wire and, using an appropriate electrical terminal, connect it to the common terminal of the switch.
8. Connect the white wire of the power cable to the load (switched) side of the switch.
9. If not already, mount the switch to the motorcycle's instrument panel, or other customer-selected location.
10. Obtain the 3-amp AGC-type fuse included with the cable, and install it into the fuse holder.
11. Tie and stow these wires as necessary so they remain out of the way of casual contact and wire chafe is avoided.
12. Label this power switch accordingly. For example: "**RADIO ON/OFF.**"

10.1.4.2.3 Control Head and Radio Are "Hot Wired"

In the "hot-wired" configuration, the control head and radio are turned on and off only by the control head's on/off/volume control located on the front panel of the control head. In this configuration, the control head's white wire must be connected to **unswitched and fused 12-volt** vehicle power. Follow the procedure presented in Section 10.1.4.2.1, except connect the white wire to **unswitched** battery power instead of switched ("Accessory") power.

10.2 CAN CABLE CONNECTIONS

10.2.1 General Information

As illustrated in Figure 10-1, the radio installation requires a Controller Area Network (CAN) cable between the radio and the control head, a CAN terminator at the radio, and a CAN terminator at the control head. The radio and the control head each have two (2) CAN port connectors on the rear panel.

10.2.2 Make CAN Link Terminations and Cable Connection

Follow this procedure to make the CAN line interconnections:

1. Mate a CAN terminator (item 14 in Table 4-2) onto either one of the two smaller 3-pin CAN port connectors on the rear panel of the CH-721. This action makes the CAN termination at the control head end of the CAN link.



When mating any CAN connection (terminators and cables) to a rear panel connector, visually align the 3/4-moon-shaped keys of the connectors, and then gently push and turn the outer locking ring of the plug (male) connector clockwise until it stops. A mild click will be sensed to confirm proper mating. Without visual alignment as a guide, it is possible with excessive force to mate the CAN connectors improperly. Damage to the connector(s) may result. Therefore, visual alignment is recommended when mating CAN connectors.

2. Obtain a CAN cable and mate it to the other CAN port connector on the rear panel of the CH-721. Typically, item 13 in Table 4-2 is utilized, a 30-foot CAN cable.

3. Make a service loop in the cable near the back of the control head.
4. Route the cable from the rear of the control head to the weather-resistant motorcycle radio case. If the control head is mounted on the motorcycle's handlebars, leave sufficient slack in the cable to allow for full handlebar steering/travel without any stretching of the cable. Protect the cable from chafing.

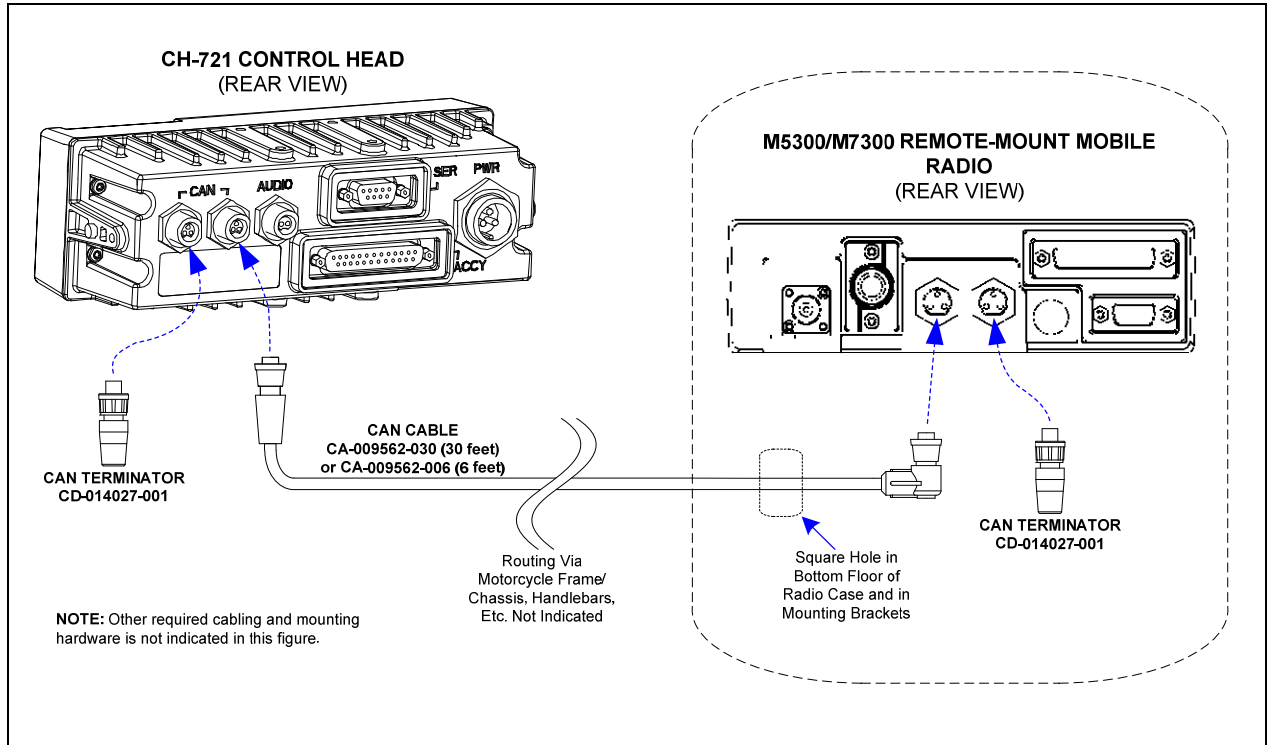

Figure 10-1: CAN Terminators and Control Head-to-Radio CAN Cable Connection

5. Route the CAN cable it into the case by passing it through the square hole in the bottom floor case.
6. Mate this end of the cable to one of the two CAN port connectors on the rear panel of the radio.
7. Mate another CAN terminator to the other CAN port connector on the rear panel of the radio. This action makes the CAN termination at the radio-end of the CAN link.
8. Loop, tie and stow the excess cable as necessary, leaving a service loop at the back of the radio and at the back of the control head.

11 HEADSET/PORTABLE RADIO CONNECTIONS

Several different-type headsets are available for use with a motorcycle-mounted M5300/M7300 mobile radio. These headsets have helmet-mounted noise-canceling microphones, and either single or dual-speakers. The headsets can be attached to helmets.

In addition, several different-type helmet headset interface cables are available. These cables include those with either pushbutton or rocker-type PTT switches, both with and without CG disable switches.

Also, belt-box cable assemblies are available. A belt box allows connection of either a headset or a portable radio to the mobile radio.

Respective option numbers are listed in Table 4-6 on page 27.



NOTE

Headset speakers have a nominal impedance of 24 ohms. Using a headset with a different speaker impedance value will result in non-optimum sound performance from the speaker(s). The SM-KA-23 dual-speaker helmet kit has its two speakers wired in parallel. They must be re-wired in series to perform properly.



NOTE

Headset Helmet Kit Interface Cables SM-MCH-71GT and SM-MCK-71GT each have a pushbutton switch that only supports the PTT function. However, Headset Helmet Kit Interface Cables SM-MCH-72GT, SM-MCK-72GT, and SM-MCH-73GT each have a three-position rocker switch that supports both the PTT and CG decode disable functions.

11.1 CONNECTING A HEADSET TO THE RADIO (WITHOUT BELT BOX)

To connect a headset to the M5300/M7300 mobile radio (without using a belt box), follow this procedure:

1. Open the motorcycle radio case.
2. As illustrated in Figure 11-1 on page 55, connect the male 44-pin D-subminiature (DB-44) connector of Headset Adapter Cable CA-012349-002 to the female DB-44 connector on the rear of the radio. Using a small flat-blade screwdriver, tighten the two (2) jackscrews securely.
3. Mate the male DB-25 connector of Accessory Cable 19B802554P24 to the female DB-25 connector of the Headset Adapter Cable. Tighten the two (2) jackscrews securely.
4. Route the Accessory Cable's round 8-pin waterproof connector through the square hole in the bottom floor of the motorcycle radio case. This cable's connector must be located near the motorcycle operator's/rider's hip position, typically near the front of the saddle (i.e., motorcycle's seat). The connector should remain at least partially exposed so the operator/rider can easily connect to and disconnect from it as necessary. Tie and stow the cable securely under the saddle.
5. Inside the case, coil-up these two cables and tie and stow them securely. The female DB-25 end of the Accessory Cable is not normally used in M5300/M7300 mobile radio motorcycle applications.
6. Install the headset into the helmet per instructions provided with the headset.
7. Install the PTT switch of the Headset Helmet Kit Interface Cable (option number SM-MCH-71GT, etc.) by first mounting the PTT switch to the motorcycle's handlebar. The PTT switch may or may not also have a CG disable switch. Typically, the PTT switch is mounted to the left handlebar. Insure the switch and its cable installation does not obstruct movement of the handlebar or other motorcycle controls in any way.

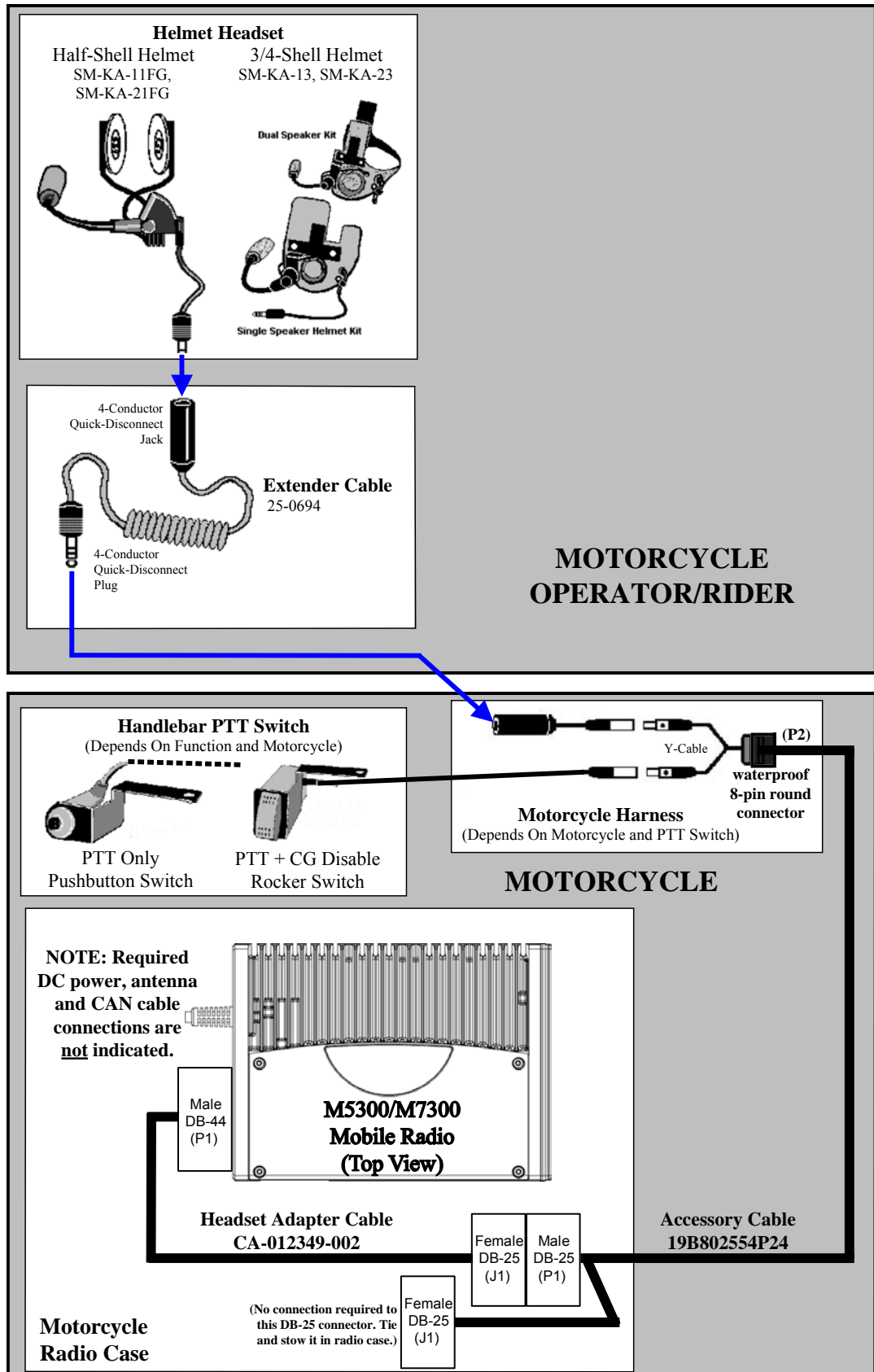

Figure 11-1: Headset-to-Mobile Radio Connection



NOTE

To enable the PTT switch on the handlebar switch for external headset options, the mobile radio must be programmed so its INP2 input is defined as “PTT” or “EXTPTT”. Without this software programming, the radio cannot be keyed via a headset.

8. Continue installation of the PTT switch by routing its small plug to the location near the round 8-pin waterproof connector of Accessory Cable 19B802554P24.
9. Connect the Y-cable’s 8-pin connector to the 8-pin connector of Accessory Cable 19B802554P24. Refer to Figure 11-1 as necessary.
10. Connect the PTT switch to the Y-cable by mating the plug on the end of the switch’s cable to the jack of the Y-cable.
11. As illustrated in Figure 11-1, use Extender Cable SM-25-0694 (or equivalent) to connector the headset to the Y-cable.

11.2 CONNECTING A HEADSET/PORTABLE RADIO TO THE MOBILE RADIO (WITH BELT BOX)

To connect a headset to the M5300/M7300 mobile radio if a belt box is not required, follow this procedure.

1. Open the motorcycle radio case.
2. As illustrated in Figure 11-2 on page 57, connect the male 44-pin D-subminiature (DB-44) connector of Headset Adapter Cable CA-012349-002 to the female DB-44 connector on the rear of the radio. Using a small flat-blade screwdriver, tighten the two (2) jackscrews securely.
3. Mate the male DB-25 connector of Accessory Cable 19B802554P24 to the female DB-25 connector of the Headset Adapter Cable. Tighten the two (2) jackscrews securely.
4. Route the Accessory Cable’s round 8-pin waterproof connector through the square hole in the bottom floor of the motorcycle radio case. This cable’s connector must be located near the motorcycle operator’s/rider’s hip position, typically near the front of the saddle (i.e., motorcycle’s seat). The connector should remain at least partially exposed so the operator/rider can easily connect to and disconnect from it as necessary. Tie and stow the cable securely under the saddle.
5. Inside the case, coil-up these two cables and tie and stow them securely. The female DB-25 end of the Accessory Cable is not normally used in M5300/M7300 mobile radio motorcycle applications.
6. Install the headset into the helmet per instructions provided with the headset.
7. Install the PTT switch of the Headset Helmet Kit Interface Cable (option number SM-MCH-71GT, etc.) by first mounting the PTT switch to the motorcycle’s handlebar. The PTT switch may or may not also have a CG disable switch. Typically, the PTT switch is mounted to the left handlebar. Insure the switch and its cable installation does not obstruct movement of the handlebar or other motorcycle controls in any way.



NOTE

To enable the PTT switch on the handlebar switch for external headset options, the mobile radio must be programmed so its INP2 input is defined as “PTT” or “EXTPTT”. Without this software programming, the radio cannot be keyed via a headset.

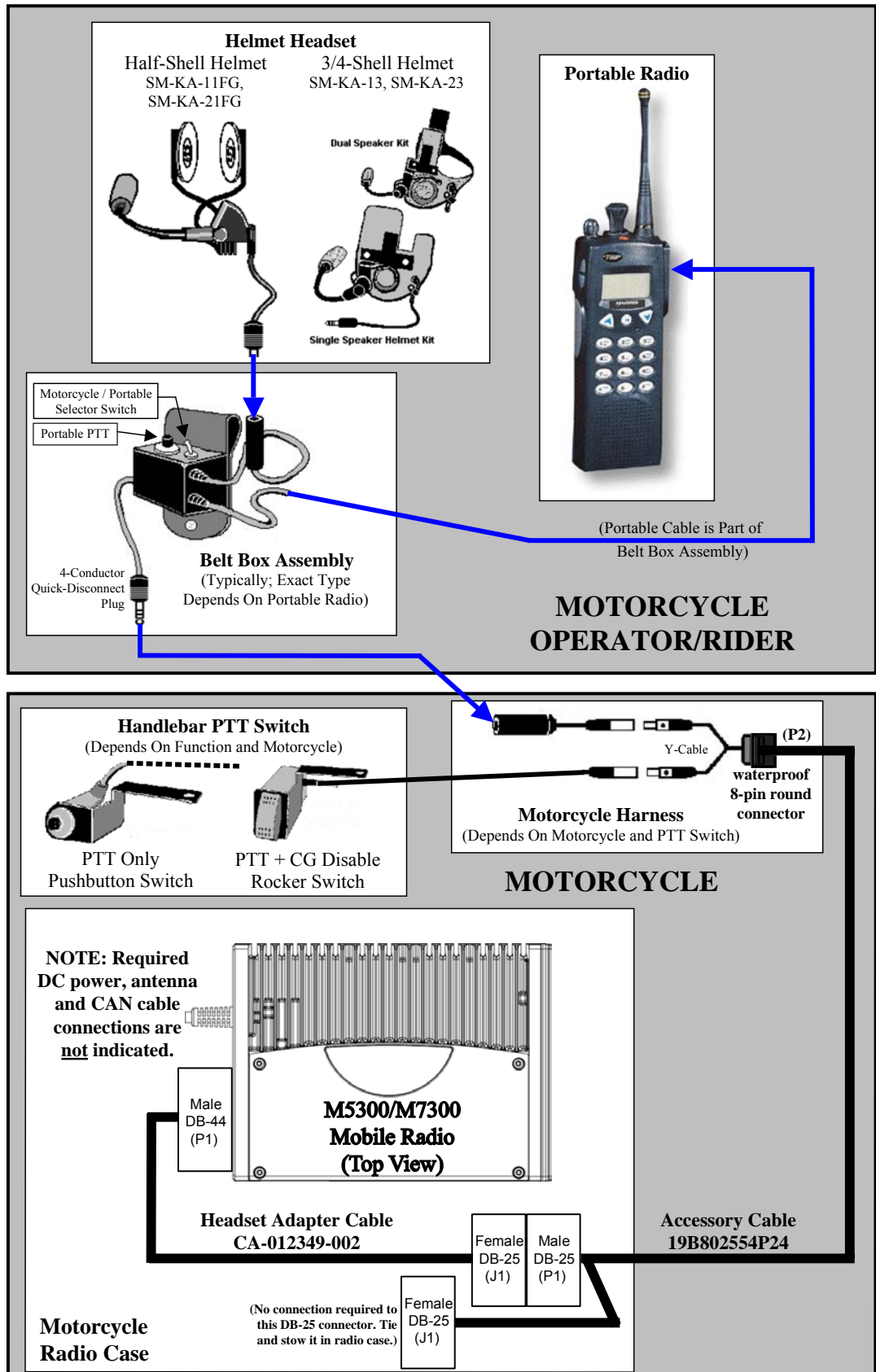

Figure 11-2: Headset/Portable Radio-to-Mobile Radio Connection

8. Continue installation of the PTT switch by routing its small plug to the location near the round 8-pin waterproof connector of Accessory Cable 19B802554P24.
9. Connect the Y-cable's 8-pin connector to the 8-pin connector of Accessory Cable 19B802554P24. Refer to Figure 11-2 as necessary.
10. Connect the PTT switch to the Y-cable by mating the plug on the end of the switch's cable to the jack of the Y-cable.
11. Route the long end of the Y-cable (with the 4-conductor quick-disconnect jack) to a location near hip-position of the motorcycle operator, or to another convenient location per request of the motorcycle operator/customer.
12. As illustrated in Figure 11-2, connect the Belt Box to the Y-cable's 4-conductor quick-disconnect jack.

11.3 HEADSET OPERATION

If the motorcycle is equipped with Headset Helmet Kit Interface Cable option SM-MCH-71GT or SM-MCK-71GT, to transmit, simply press and hold the PTT button on the PTT switch then talk into the headset's mic. To receive, stop talking and release the PTT button. When receiving, adjust the volume control on the control unit for the desired speaker audio level.

If the motorcycle is equipped with Headset Helmet Kit Interface Cable option SM-MCH-72GT, SM-MCH-73GT or SM-MCK-72GT, to transmit, press and hold the three-position toggle switch to its momentary (PTT) position and then talk into the headset's mic. To receive, stop talking and release the toggle switch so it returns to its center position. In the center position, the radio is in monitor mode (programmed receive decoder is deactivated). To exit the monitor mode and re-activate the programmed receive decoder, press the toggle switch to the latched position. When receiving, adjust the volume control on the control unit for the desired speaker audio level.

12 MICROPHONE ATTACHMENT

There are several versions of microphones available for use with the radio. Each has a 17-pin flush-mount type connector that mates with the mic connector on the front panel of the control head. The mic's connector includes a captive thumbscrew that secures it to the mic connector on the front panel of the control head. A microphone clip is included with each microphone. The radio can be configured to provide a monitor function when the microphone is cradled in the clip. Connect the mic to the control head and install the clip as follows:

1. Select a mounting surface location that has clearance for the mic when it is stowed in the clip, and then attach the microphone clip to the surface. The use of self-locking hardware (i.e., machine screws with washers and self-locking nuts) is recommended. Tighten securely.
2. Using the microphone clip as a template, drill mounting holes in the surface of the selected location.
3. The microphone clip must be grounded to the vehicle's chassis. If not mounted to a grounded metal surface, complete this requirement by adding a jumper wire attached from chassis ground to the clip.
4. As illustrated in Figure 12-1, grasp the mic's connector with a thumb and index finger on the sides of the connector just adjacent to the thumbscrew.
5. Position connector just in front of the control head's mic connector so its male pins can engage straight into the female (socket) pins of the control head's mic connector. The thumbscrew must be oriented directly above the hanging mic cable.
6. Mate the two connectors by pressing them fully together. Do not apply any force to the thumbscrew when mating the connectors.
7. Tighten the thumbscrew finger-tight. Do not use a screwdriver to tighten it.
8. Clip the microphone to the clip.

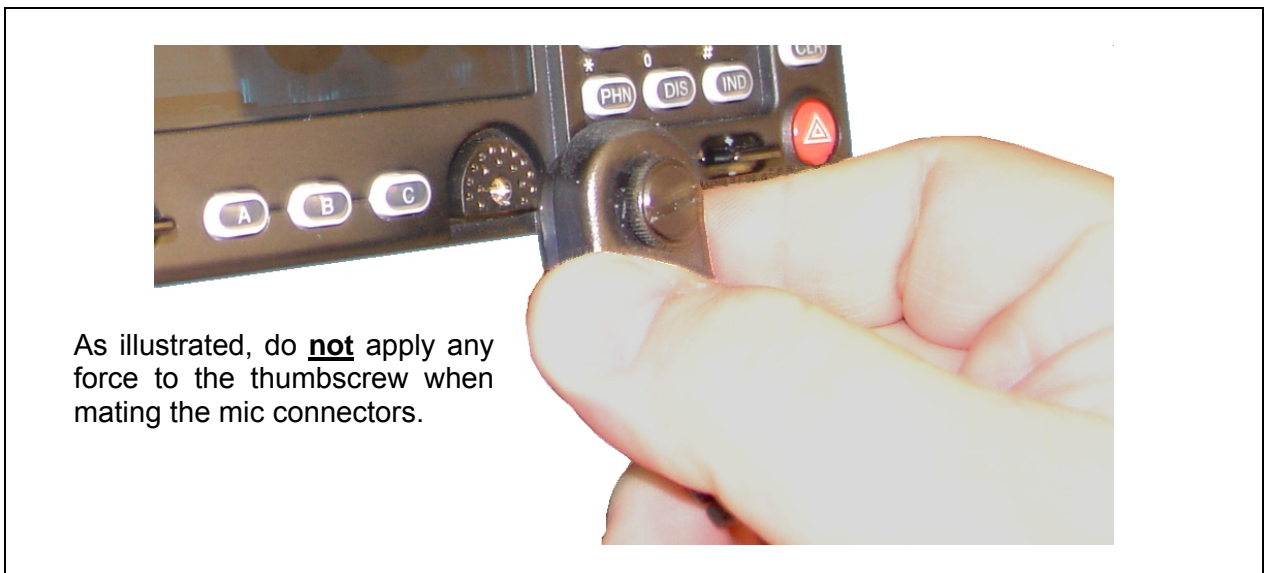

Figure 12-1: Attaching the Microphone to the CH-721 Control Head

13 OPTIONAL CABLES

13.1 M5300/M7300 OPTION CABLE CA-012349-001

M5300/M7300 Option Cable CA-012349-001 connects to the 44-pin I/O connector on the rear of the radio. It breaks out into several smaller standardized connectors, allowing straightforward access to external I/O interfaces provided by the radio. The cable also shortens radio removal and re-installation time when required. The cable is shown in Figure 13-1 below, and pin-out details are included in Table 13-1. The cable's 44-pin D-subminiature connector that mates with the connector on the rear of the radio is identified P1.

P2, the cable's 2-pin connector, provides connections for an external speaker in a front-mount M5300/M7300 mobile radio installation. P2 is not used in motorcycle installations, which employ a remote-mount M5300/M7300 mobile radio. In this case, the speaker connection is made at the rear of the CH-721 control head as the audio amplifier in the control head drives the external speaker.

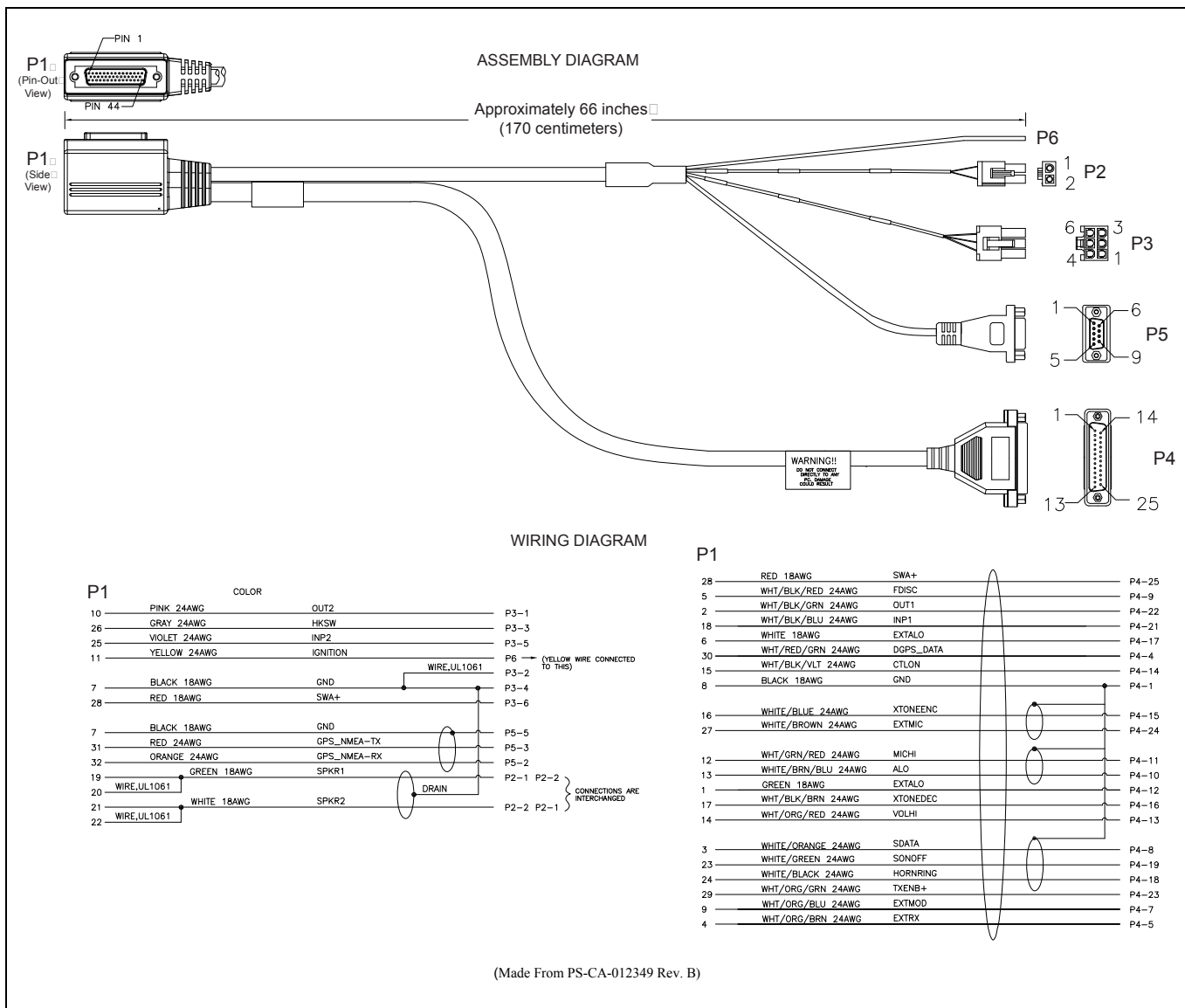

Figure 13-1: M5300/M7300 Option Cable CA-012349-001

P3, the cable's 6-pin connector, is a connector for basics accessories (e.g., hookswitch, etc.).

P4, the cable's 25-pin D-subminiature (DB-25) connector, provides audio and data connections for connections to optional equipment.

P5, the cable's 9-pin D-subminiature (DB-9) connector, is not used in motorcycle applications of the radio. In standard mobile applications of the radio, this connector provides NMEA-formatted GPS serial data connections for the external computer processing the NMEA-formatted GPS data received by the radio's internal GPS receiver.

Table 13-1: M5300/M7300 Option Cable CA-012349-001 Interconnections

44-PIN I/O CABLE CONNECTOR P1 PIN	SIGNAL NAME	TO/FROM	DESCRIPTION
19	SPKR1	P2 pin 1	Speaker Audio Outputs 1 and 2. These speaker outputs are <u>not</u> used in a motorcycle installation, since the audio amplifier in the CH-721 control head drives the external speaker.
20	SPKR1		
21	SPKR2	P2 pin 2	
22	SPKR2		
10	OUT2	P3 pin 1	Digital Output 2 (open-collector).
7	GND	P3 pins 2 & 4	Chassis Ground (fused on radio's PK Board at 3.15 amps).
26	HKSW	P3 pin 3	Hookswitch Digital Input. Active = Ground. Inactive = Open.
25	INP2	P3 pin 5	Digital Input 2.
28	SWA+	P3 pin 6	Switched A+ (DC Power) Output.
8	GND	P4 pin 1	Chassis ground (fused on PK Board at 3-amps).
30	DGPS_DATA	P4 pin 4	GPS Serial Data. This connection is <u>not</u> used in a motorcycle installation.
4	EXTRX	P4 pin 5	External Rx Audio Output. This connection is <u>not</u> used in a motorcycle installation.
9	EXTMOD	P4 pin 7	External Tx Audio Input. This connection is <u>not</u> used in a motorcycle installation.
3	SDATA	P4 pin 8	In a motorcycle installation (i.e., remote-mount radio), this pin on the radio's DB-44 connector is <u>not</u> functional. For siren/PA interfacing, use the respective pins on the CH-721 Option Cable's female DB-25 connector. See Section 13.5 for additional information.
5	FDISC	P4 pin 9	Buffered Discriminator Audio. This connection is <u>not</u> used in a motorcycle installation.
13	ALO	P4 pin 10	Audio Ground/Reference (fused on radio's PK Board at 3.15 amps).
12	MICHI	P4 pin 11	In a motorcycle installation (i.e., remote-mount radio), this MICHI input is <u>not</u> functional. For siren/PA interfacing, use the respective pins on the CH-721 Option Cable's female DB-25 connector. See Section 13.5 for additional information.
1	EXTALO	P4 pin 12	
14	VOLHI	P4 pin 13	Volume High. This connection is <u>not</u> used in a motorcycle installation.
15	CTLON	P4 pin 14	Control On Digital Output.

Table 13-1: M5300/M7300 Option Cable CA-012349-001 Interconnections

44-PIN I/O CABLE CONNECTOR P1 PIN	SIGNAL NAME	TO/FROM	DESCRIPTION
16	XTONEENC	P4 pin 15	External Tone Encode Audio. This connection is <u>not</u> used in a motorcycle installation.
17	XTONEDEC	P4 pin 16	External Tone Decode Audio. This connection is <u>not</u> used in a motorcycle installation.
6	EXTALO	P4 pin 17	External Audio Output. This connection is <u>not</u> used in a motorcycle installation.
24	HORNRING	P4 pin 18	In a motorcycle installation (i.e., remote-mount radio), these two (2) pins are <u>not</u> functional. For siren/PA interfacing, use the respective pins on the CH-721 Option Cable's female DB-25 connector. See Section 13.5 for additional information.
23	SONOFF	P4 pin 19	
18	INP1	P4 pin 21	Digital Input 1.
2	OUT1	P4 pin 22	Digital Output 1 (open-collector).
29	TXENB+	P4 pin 23	Transmit Enable B+.
27	EXTMIC	P4 pin 24	Pin 27 of the radio's DB-44 connector is the radio's External Mic Audio Input for a headset microphone (or any second mic audio source such as a boom mic or mic audio from a portable radio (via a belt box)). For a standard headset installation, use Headset Adapter Cable CA-012349-002 and Accessory Cable 19B802554P24, <u>not</u> Option Cable CA-012349-001. See Section 11 for additional information.
28	SWA+	P4 pin 25	Switched A+ DC Power Output.
32	GPS_NMEA_RX	P5 pin 2	Serial Rx Input for GPS NMEA-Formatted Serial Data. This connection is <u>not</u> used in a motorcycle installation.
31	GPS_NMEA_TX	P5 pin 3	Serial Tx Output for GPS NMEA-Formatted Serial Data. This connection is <u>not</u> used in a motorcycle installation.
7	GND	P5 pin 5	Ground for GPS Serial Data Signals (fused on radio's PK Board at 3.15 amps). This connection is <u>not</u> used in a motorcycle installation.
11	IGNITION	(no connection)	Unused/Spare ignition sense input.
33 through 44	—	(no connections)	These pins of P1 are not used/not connected.

13.2 HEADSET ADAPTER CABLE CA-012349-002

As described in Section 11 of this manual, Headset Adapter Cable CA-012349-002 is required to connect a headset or a portable radio (via belt box) to the M5300/M7300 mobile radio. The cable's assembly diagram is shown in Figure 13-2 below.

The cable's male 44-pin D-subminiature (DB-44) connector, identified P1, mates with the female DB-44 connector on the rear of the radio.

The cable's female DB-25 connector, identified J1, mates to the male DB-25 connector of Accessory Cable 19B802554P24. Refer to Section 11 for additional information. Accessory Cable 19B802554P24 is illustrated in Section 13.3 that follows.

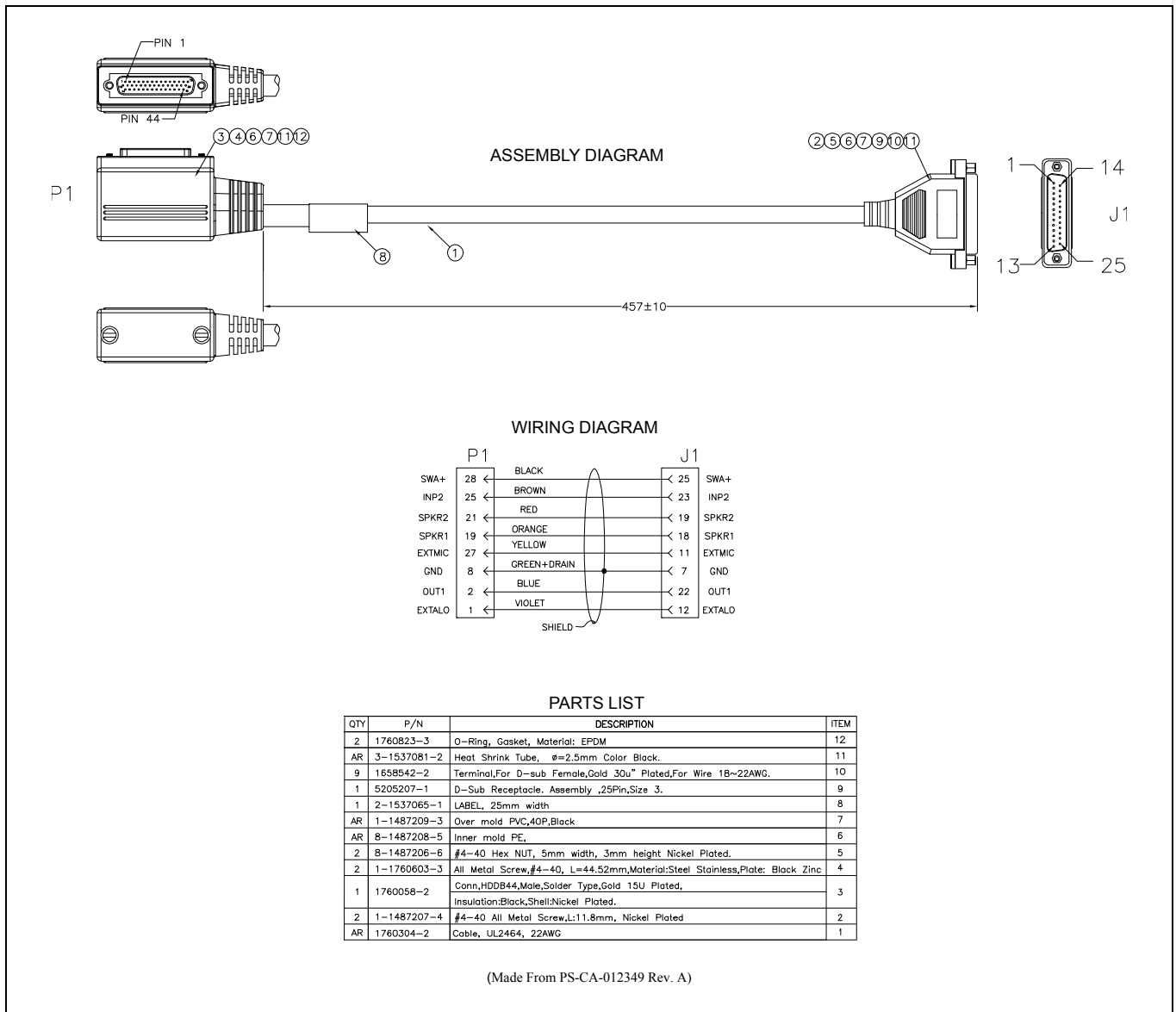

Figure 13-2: Headset Adapter Cable CA-012349-002

13.3 ACCESSORY CABLE 19B802554P24

Accessory Cable 19B802554P24 is required when making headset and/or portable radio connections as described in Section 11 of this manual. As illustrated in Figure 11-1 (page 55) and Figure 11-2 (page 57), this cable's male DB-25 connector, identified P1, mates to the female DB-25 connector of Headset Adapter Cable CA-012349-002. The cable's round 8-pin waterproof connector, identified P2, mates to the motorcycle harness Y-cable. In non-M5300/M7300 applications, Accessory Cable 19B802554P24 also supports connections to an external siren and light system via its connector J1.

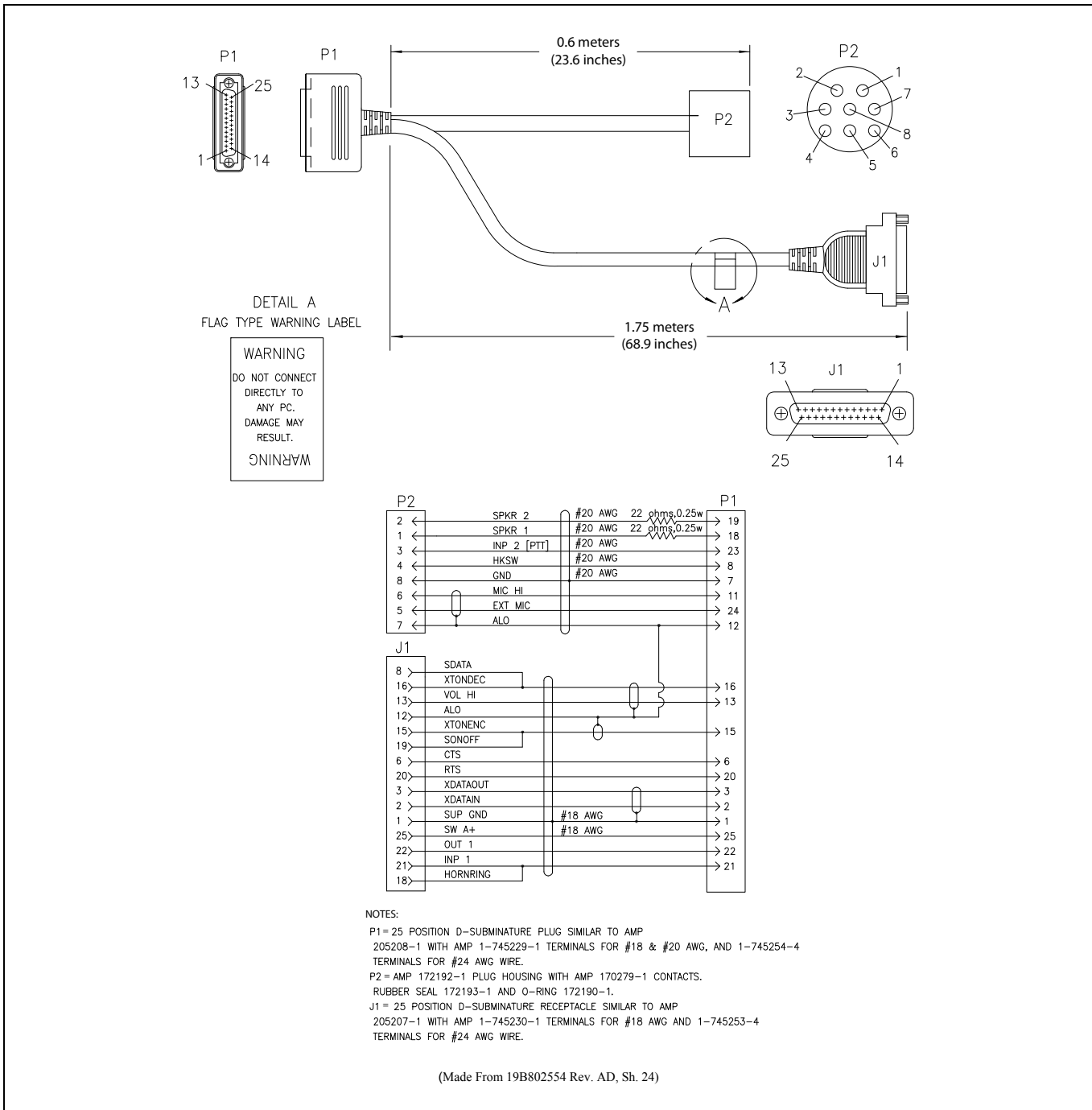

Figure 13-3: Accessory Cable 19B802554P24

13.4 SERIAL PROGRAMMING CABLES CA-013671-010 AND -020

Serial Programming Cable CA-013671-010 (10 feet long) and CA-013671-020 (20 feet long) can be used to program and configure the M5300/M7300 mobile radio via a Personal Computer (PC). This cable has a female DB-9 connector on one end for connection to the PC's serial port and a male DB-9 connector on the other end for connection to the serial port on the rear of the radio. The cable's assembly and wiring diagrams are shown in Figure 13-4 below.

If the utilized PC is not equipped with a DB-9 serial port connector, the use of a suitable adapter will be required, such as USB-to-RS-232 Adapter Cable CN24741-0001.

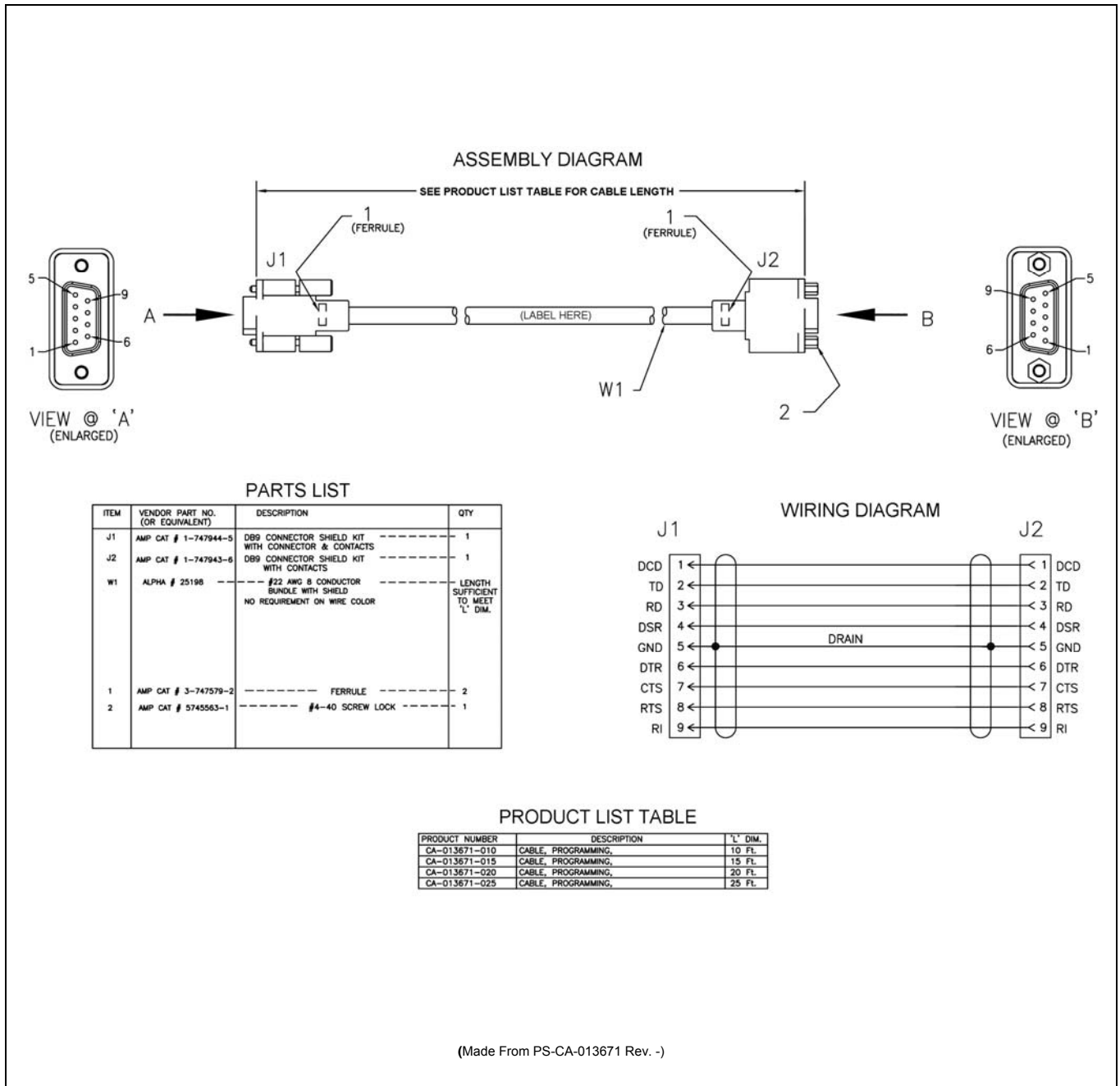
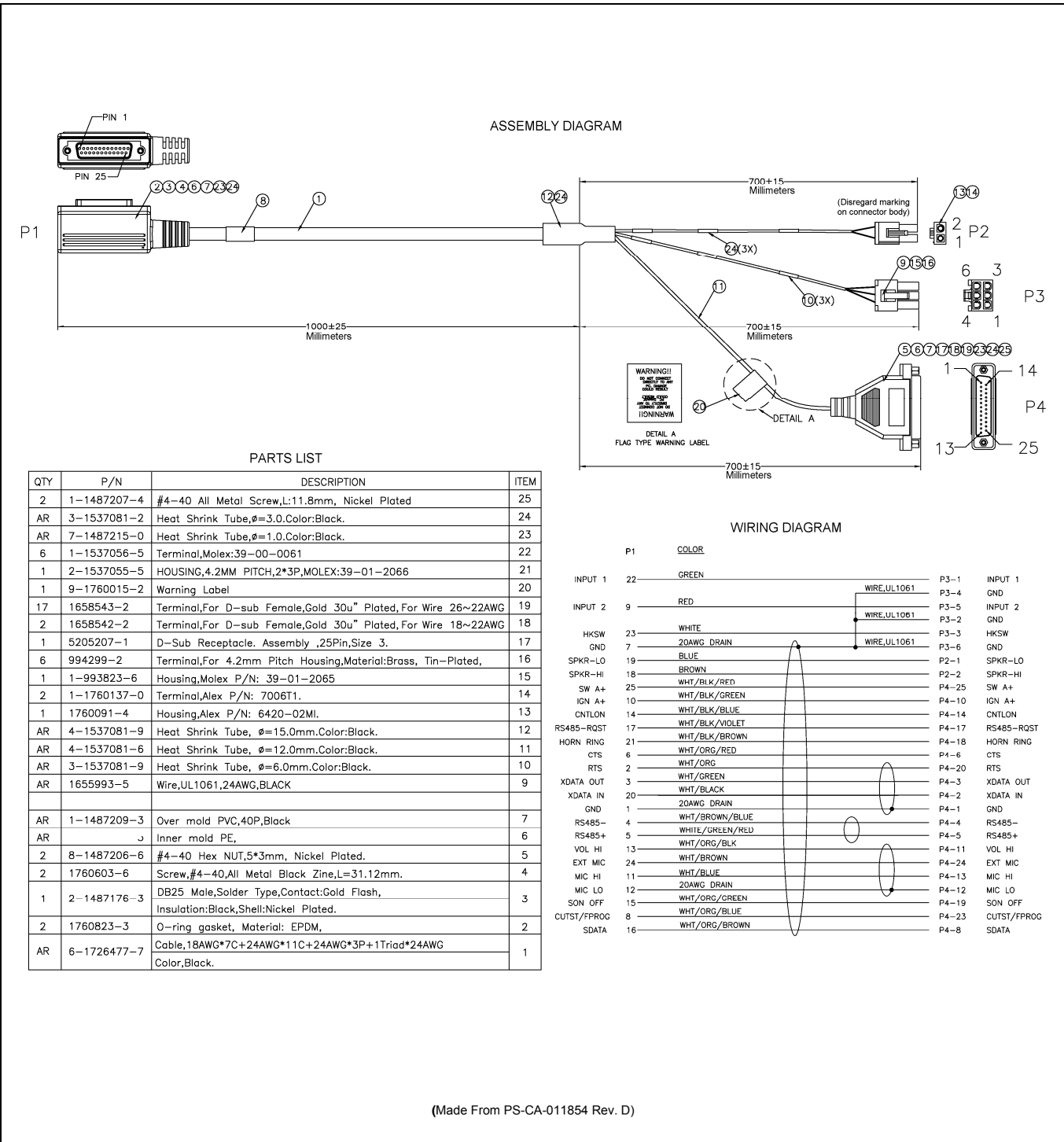

Figure 13-4: Programming Cables CA-013671-010 and CA-013671-020

13.5 CH-721 OPTION CABLE CA-011854-001

CH-721 Option Cable CA-011854-001 can be used to connect optional equipment to the 25-pin D-subminiature (DB-25) connector on the rear of the CH721. This cable expands the connections available at the 25-pin connector to three (3) separate connectors. The cable's assembly and wiring diagrams are shown in Figure 13-5 below.



(Made From PS-CA-011854 Rev. D)

Figure 13-5: CH-721 Option Cable CA-011854-001

13.6 CH-721 SERIAL PROGRAMMING CABLE CA-104861

Serial Programming Cable CA-104861 (5 feet) can be used to program and configure the CH-721 control head via a Personal Computer (PC). This cable has a female DB-9 connector on one end for connection to the PC's serial port and a male DB-9 connector on the other end for connection to the serial port on the rear of the head. The cable's assembly and wiring diagrams are shown in Figure 13-6 below.

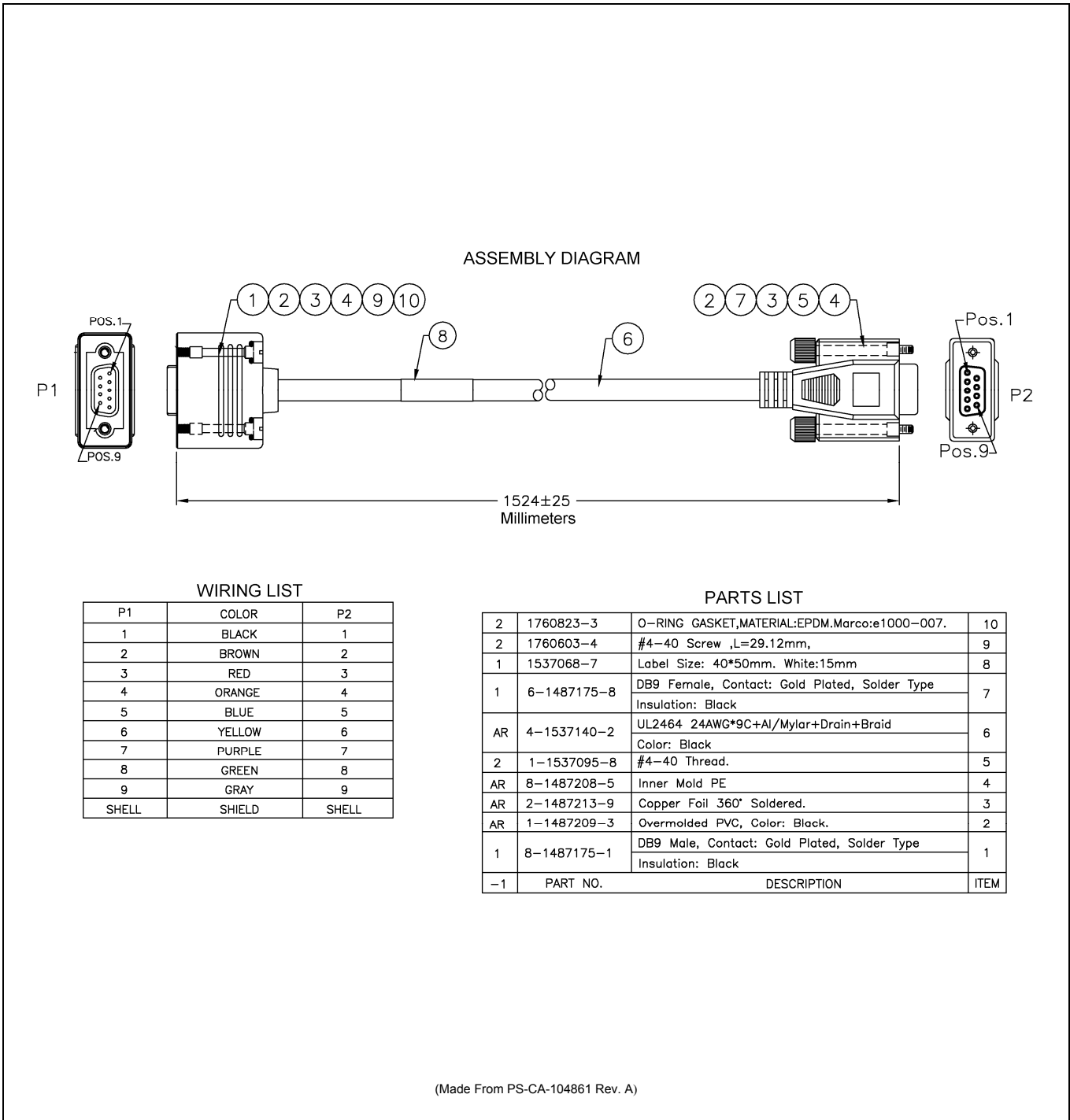

Figure 13-6: Programming Cable CA-104861

14 INITIAL POWER-UP TEST

1. At the radio's main waterproof (HFB-type) fuse holder installed near the vehicle battery, insert the 15-amp AGC-type fuse that was included with the radio's DC Power Cable.
2. Tie and stow all fuse holders at this location to prevent excess vibration/movement.
3. Carefully reconnect the vehicle's battery ground cable.
4. If not already, temporarily connect the mobile antenna cable from the vehicle-mounted mobile antenna to the female TNC RF connector on the rear panel of the radio. This is a temporary connection until test procedures in Section 15 are complete.
5. If the installation is wired so the vehicle's ignition key/switch turns the radio on and off, turn the switch to the Accessory or Run position.
6. If the control head is not already powered up, do so by rotating its on/off/volume control clockwise out of the detent position.
7. Verify the control head has powered-up by observing its display. If the display is not lit, refer to Section 10.1.1 as necessary.



Unlike many mobile radio products, the radio powers-up to the **state of last control**.

As long as the software configuration parameters have been loaded, successful installation is almost immediately realized:

- After a short boot-up sequence, the control head displays login information and/or a talk group.
- If no errors are displayed, the installation is most-likely properly wired.
- If an error is displayed, recheck all cable connections, verify all fuses are properly installed, and verify battery power on the load side of the fuses, etc. If problems persist, contact the Technical Assistance Center (see page 19).
- Consult the Operator's Manual for operational information.

Refer to the following section for performance test information.

15 SETTING MAXIMUM TRANSMIT POWER LEVEL AND ANTENNA PERFORMANCE TESTS

This section includes procedures to set the radio’s maximum transmit output power level and to verify the performance of the installation’s mobile antenna system. The respective subsections include:

- Changing Operating Mode for Tests
- Required Test Equipment
- Transmit Power Level Adjustments (for all operating modes)
- Transmitting into a Dummy Load (a 50-Ohm RF Terminator)
- Transmitting into the Mobile Antenna



The accuracy of test results depends upon a DC power source in the range of 13.8 to 16 volts DC, with a current capacity of greater than 8 amps. Make sure the vehicle’s battery is fully charged by running the engine for a few minutes before the test, and keep the engine running during the test procedures. **Abide by the following WARNING!**



If the vehicle’s engine must remain running, the vehicle location should be well ventilated so exhaust fumes from the engine do not cause harm!



If a vehicle equipped with this radio requires jump-starting, the radio installation’s main AGC fuse (15-amp) should be removed from the holder prior to jump-starting. Doing so will prevent damage to the radio system.

15.1 CHANGING OPERATING MODE FOR TESTS

To complete tests in this section, placing the radio in a conventional mode and using an average-responding wattmeter to measure RF transmit power is recommended. However, if the radio is not programmed for conventional mode operations (i.e., OpenSky Trunking Protocol (OTP) is available but EDACS Conventional P25 (ECP) is not), tests will require a peak-reading RF wattmeter to measure RF transmit power. To select either conventional or OpenSky mode, use one of the following procedures:

15.1.1 Changing from OpenSky to Conventional

1. If necessary, apply power to the radio and turn it on.
2. Use the control head’s **•/• Ramp Control** to scroll through the menu until **Mode Menu** appears in the middle line of the display. This control is shown in Figure 8-1 and in Figure 8-2 on page 40.
3. Use the **+/- Ramp Control** to select an available conventional channel/system.
4. Confirm the selection by pressing the **MENU** button, then toggling the **Ramp Control** once (to select **Y** for Yes), followed by pressing the **MENU** button again. The radio will enter the selected mode as indicated by the display.
5. Select a conventional channel for test transmissions using either the **•/• Ramp Control** or the **System/Group/Channel Selection Control** (required control per programming).

15.1.2 Changing from Conventional to OpenSky

1. If necessary, apply power to the radio and turn it on.
2. Use the control head's **•/•• Ramp Control** to scroll through the menu until an OpenSky system's name is displayed.
3. After a few seconds, the radio will automatically transition to OTP mode for operations on the selected OpenSky system.
4. If the radio is not programmed for auto-login, login to the OpenSky system. For login instructions, refer to the respective Operator's Manual and/or Quick-Guide as necessary. A Quick-Guide is included with the radio when it ships from the factory. Publication numbers are listed in Section 3.2 (page 18).
5. Select a talk group for test transmissions using either the **•/•• Ramp Control** or the **System-/Group/Channel Selection Control** (required control per programming).

15.2 REQUIRED TEST EQUIPMENT

Table 15-1: Required Test Equipment

TEST EQUIPMENT	MODEL / PART NUMBER & DESCRIPTION
Average-Responding Wattmeter (for conv. measurements)	Bird Electronic Corp. Model 43 (or equivalent) with Type N female connectors at input and output ports, and with wattmeter slugs appropriate for the radio's transmit RF output power capability and RF band.
or	
Peak-Reading Wattmeter (for OpenSky measurements)	Bird Electronic Corp. Model 4314B (or equivalent) with Type N female connectors at input and output ports.
RF Coaxial Jumper Cable	Pasternack Enterprises PE3661-(length per CAUTION on page 74) 50-Ohm Coaxial Cable with TNC male connector and Type N male connector. The utilized cable must have VSWR below 1.5:1 within the RF passband. Refer to the CAUTION on page 74 for information on the required length of this cable.
N-to-TNC RF Adapter	Pasternack Enterprises PE9090 (or equivalent) Type N male to TNC female adapter. Required to connect the cable of the vehicle-mounted antenna to the wattmeter.
50-Ohm RF Terminator ("Dummy Load")	Pasternack Enterprises PE6106 (or equivalent) 50-ohm RF terminator rated at greater than 50 watts power, with Type N male connector.
Vehicle-Mounted Antenna	Tests are performed with the vehicle-mounted antenna per the installation described in Section 7 of this manual.
Desktop or Laptop Personal Computer (PC)	With Microsoft Windows operating system and a terminal application to issue commands through a serial port (such as HyperTerminal). For EDACS/ProVoice, P25 and conventional operating mode, utilized PC must have RPM radio programming software installed.
Serial Cable	MAMROS0055 (6 feet), or cable CA-013671-010 (10 feet) or CA-013671-020 (20 feet).
Optional: USB-to-RS-232 Adapter	Required if the utilized PC is not equipped with a standard DB-9 serial port connector.

15.3 TRANSMIT POWER LEVEL ADJUSTMENTS

15.3.1 General Information

M5300/M7300 mobile radio factory programming sets maximum transmit RF output power to 35 watts in EDACS/ProVoice, conventional, and P25 modes, and 19 watts in OpenSky mode.

To meet the minimum safe lateral distances listed in Table 1-1 (page 8), an M5300/M7300 mobile radio used in a motorcycle application must be programmed for a **transmit RF output power level that does not exceed 20 watts**. This reduced radio transmit RF output power level also lowers the overall DC load on the motorcycle's battery and battery charging system (i.e., alternator). Motorcycles with mobile radios are typically equipped with additional lights, light flashers, sirens, a PA system, and other electrical equipment which place additional demand on the motorcycle's battery and battery charging system.



In a motorcycle application, do **not** use an M5300/M7300 mobile radio with a transmit RF output power level exceeding 20 watts. Doing so violates the maximum regulatory RF power rating specified for this application. In addition, exceeding 20 watts may result in damage to the motorcycle's charging system, battery, and other electrical circuits.

Transmit power level adjustment procedures are presented in the following subsections for all operating modes. Typically, adjustment (a reduction in transmit RF output power) will be required for EDACS/ProVoice, conventional, and P25 (ECP) operating modes.

15.3.2 Adjusting Maximum Transmit Output Power for EDACS/ProVoice, Conventional, and P25 Modes

Adjustment is performed by the Radio Personality Manager (RPM) software application. Follow this procedure to program each radio system for a 20-watt or less transmit output power level:

1. Connect the radio's DB-9 serial port connector to a Personal Computer (PC) that has a terminal application installed, such as Microsoft Windows HyperTerminal. To make this connection, use cable MAMROS0055 (6 feet), cable CA-013671-010 (10 feet) or cable CA-013671-020 (20 feet). Also, if the utilized PC is not equipped with a DB-9 serial port connector, the use of a suitable adapter will be required, such as USB-to-RS-232 Adapter Cable CN24741-0001.
2. Power-up the radio and allow time for it to boot-up.
3. Start-up RPM and read the radio's personality.
4. Double-click the Systems tab to open the System Setup dialog box. Figure 15-1 shows a typical dialog box.
5. Each radio system listed in the System Name list has a maximum power level which is set via the respective Power Level text box. Enter the required maximum power (in watts) on a per-system basis. Do **not** enter a setting of more than 20 (for 20 watts).
6. Click on each name in the System Name list as required to verify each radio system in the personality has a Power Level setting of **20 watts or less**.
7. Send the updated personality to the radio.
8. Save the updated personality as necessary.

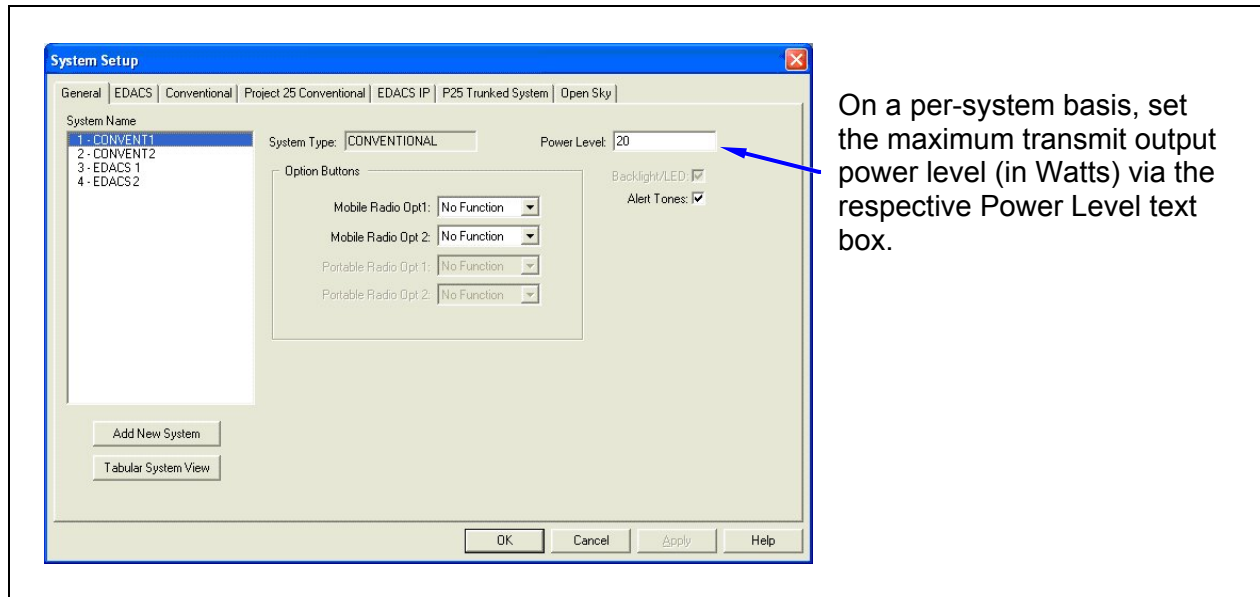

Figure 15-1: Setting Maximum RF Output Power Level via RPM’s System Setup Dialog Box

15.3.3 Adjusting Maximum Transmit Output Power for OpenSky Mode (Optional)

If necessary, follow this procedure to adjust the radio’s OpenSky (OTP) mode maximum transmit RF output power level. A reduction in power level from the factory default setting of 19 watts (earlier radios were 15 watts) will reduce the load on the motorcycle’s battery and battery charging system (i.e., alternator) during radio transmission:

1. Connect the radio’s DB-9 serial port connector to a Personal Computer (PC) that has a terminal application installed, such as Microsoft Windows HyperTerminal. To make this connection, use cable MAMROS0055 (6 feet), cable CA-013671-010 (10 feet) or cable CA-013671-020 (20 feet). Also, if the utilized PC is not equipped with a DB-9 serial port connector, the use of a suitable adapter will be required, such as USB-to-RS-232 Adapter Cable CN24741-0001.
2. Start-up the PC and configure the terminal application to use the respective serial communication port (e.g., COM1) with the following settings: terminal emulation = VT100, data rate = 19,200 bps, number of data bits = 8, number of stop bits = 1, no parity, and no flow control.
3. Power-up the radio and allow time for it to boot-up.
4. Verify the radio is operating in OpenSky mode. If not, refer to Section 15.1.2 on page 70 as required, and make the change to this mode.
5. Send these two 3-character strings to the radio to initialize its serial port for OTP commands:
 - +++ (hold down the <Shift> key and press the + key three times)
 - *** (hold down the <Shift> key and press the * key three times)

6. Send the following command to the radio via the terminal application:

at*** <maximum transmit power>** where <maximum transmit power> equals the required maximum transmit RF output power level in dBm. A space is required after at*****.

For example, to set the maximum power to 10 watts (40 dBm), send **at***** 40** to the radio.

Use the following formula to convert watts to dBm: $\text{dBm} = 10 \times \text{Log}_{10}(\text{milliwatts})$, where 1 watt = 1000 milliwatts (1 milliwatt = 0 dBm).

7. Send the following command to the radio so it will reboot and the new power setting will take effect:
atz
8. Disconnect the programming equipment and continue with the test procedure presented in the next section.

15.4 TRANSMITTING INTO A DUMMY LOAD

1. Using the Type N male to TNC male RF coaxial jumper cable, connect the radio’s antenna connector to the wattmeter’s input connector. Refer to Figure 15-2 as necessary.
2. Connect the 50-ohm dummy load to the wattmeter’s output connector, in place of the antenna cable from the mounted mobile antenna.



NOTE

As previously stated, if conventional mode is not available per radio programming (i.e., OTP mode is available but ECP mode is not), a peak-reading RF wattmeter is required to measure RF transmit power. Otherwise, the use of an average-responding wattmeter is recommended. Recommended wattmeter types are listed in Table 15-1.

3. If not already, turn the radio on and set it to the required operating mode (based upon available radio programming and test equipment). Refer to Section 15.1 as necessary.
4. Set the radio to a test talk group or conventional channel, if available.



NOTE

It is recommended that a test talk group/channel be allocated for this testing. This same group should be used during the antenna test procedure which is presented in the subsequent section.

5. Position the wattmeter’s slug to measure forward RF output power. Rotate it if necessary. The arrow on the face of the slug must point away from the radio and towards the dummy load for forward power measurements.
6. **For conventional mode transmissions**, set the wattmeter to measure average RF power.
For OpenSky mode transmissions, set the wattmeter to measure peak RF power.
7. Key the radio’s transmitter via the microphone’s PTT button.
8. Verify the measured forward RF output power into the dummy load is within 20% of the maximum transmit output power (in watts) programming performed per Section 15.3.



NOTE

Transmit only for as long as needed to take the measurement, then immediately disable the transmission.

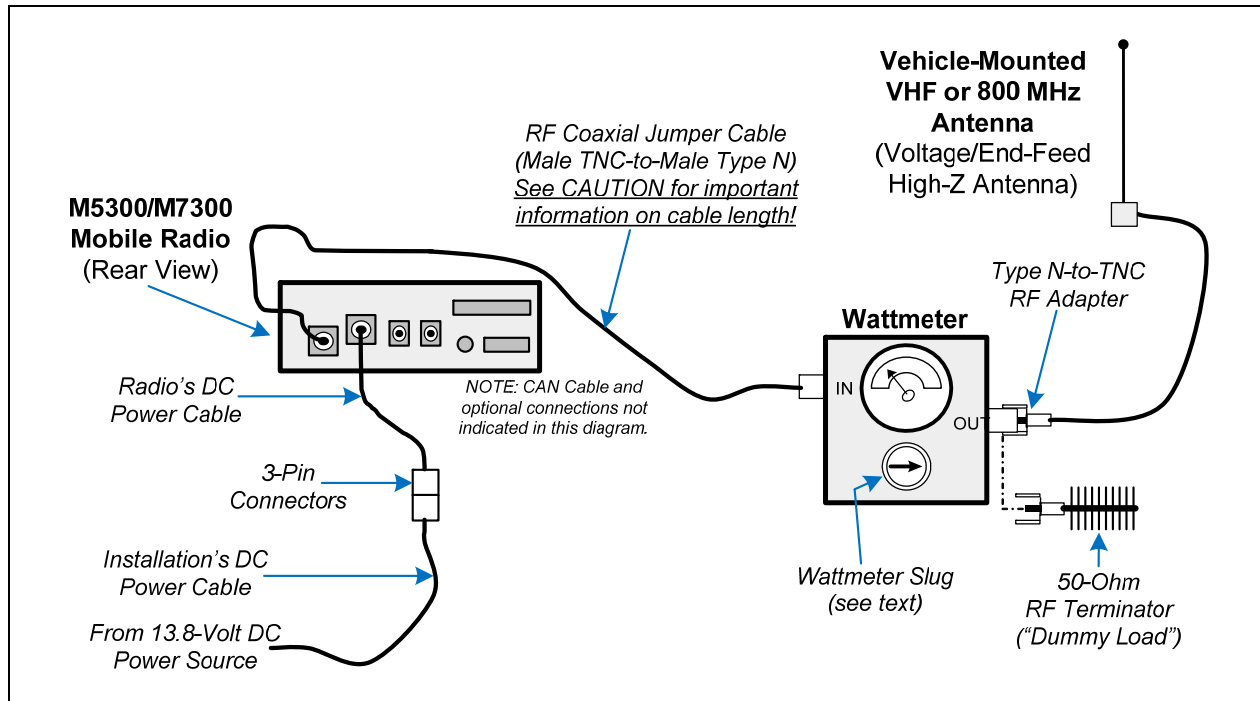

Figure 15-2: Wattmeter Connections for Antenna System Tests



For accurate RF power measurements when transmitting into the antenna, the length of the RF coaxial jumper cable plus the length of the directional coupler within the wattmeter is critical. The summed length of the coaxial jumper cable and the directional coupler must equal a multiple of a $\frac{1}{2}$ -wavelength at the test frequency, with velocity factors included in length calculations. When making length calculations, use a velocity factor of 66% for cable with solid polyethylene dielectric/insulation (such as RG-58C/U or RG-8/U), or use a velocity factor of 79% for cable with foam polyethylene dielectric/insulation (such as RG-233 or H155). For the wattmeter's directional coupler, use a velocity factor of 95%, if it is not otherwise specified by the wattmeter manufacturer.

9. **If the wattmeter reading is within the range**, record the measured value in the appropriate space on the data collection form near the end of this manual.

If the wattmeter reading is outside the range, verify the radio's power supply voltage (i.e., battery voltage) is within the specified range, recheck all connections and measure the RF output power again. If this fails to produce a reading within the range, replace the radio (reprogramming as required), and repeat this procedure. If problems persist, contact the Technical Assistance Center (see page 19).



In a motorcycle application, do **not** use an M5300/M7300 mobile radio with a transmit RF output power level exceeding 20 watts. Doing so violates the maximum regulatory RF power rating specified for this application. In addition, exceeding 20 watts may result in damage to the motorcycle's charging system, battery, and other electrical circuits.

15.5 TRANSMITTING INTO THE MOBILE ANTENNA

1. Connect the antenna cable from the vehicle-mounted antenna to the wattmeter as shown in Figure 15-2.
2. If not already, turn the radio on and set it to the required operating mode (based upon available radio programming and test equipment). Refer to Section 15.1 as necessary.
3. Set the radio to a test talk group or conventional channel, if available.



NOTE

It is recommended that a test talk group/channel be allocated for this testing. Otherwise, interference with other radio users in the system may occur. **Also, during transmissions, always observe the RF exposure-related safety information presented in Section 1.2 (begins on page 6).**

4. Position the wattmeter's slug to measure forward RF output power. Rotate it if necessary. The arrow on the face of the slug must point away from the radio and towards the antenna for forward power measurements.
5. **For conventional mode transmissions**, set the wattmeter to measure average RF power.
For OpenSky mode transmissions, set the wattmeter to measure peak RF power.
6. Key the radio's transmitter via the microphone's PTT button.
7. Verify the measured forward RF output power into the antenna is within 20% of the maximum transmit output power (in watts) programming performed per Section 15.3.



NOTE

Transmit only for as long as needed to take the measurement, then immediately disable the transmission.

8. **If the wattmeter reading is within the range**, record the value in the appropriate space on the data collection form near the end of this manual.

If the wattmeter reading is outside the range, verify the radio's power supply voltage (i.e., battery voltage) is within the specified range, recheck all connections, and measure the forward power again. If these checks/corrections fail to produce a reading within the range, check all cabling and connections and repeat the testing procedure to this point. In the event the wattmeter reading still falls outside the range, replace the antenna, make sure all connections are seated firmly, and repeat the testing procedure. If problems persist, contact the Technical Assistance Center (see page 19).

9. Position the wattmeter's slug to measure reverse (reflected) RF power from the antenna. The arrow on the face of the slug must point away from the antenna and to the radio to measure reverse power.
10. Key the radio's transmitter via the microphone's PTT button.
11. Verify the wattmeter indicates **2 watts or less**.



NOTE

Transmit only for as long as needed to take the measurement, then immediately disable the transmission.

12. **If the wattmeter reading is within the range**, record the value in the appropriate space on the data collection form near the end of this manual.

If the wattmeter reading is outside the range, make sure the antenna is consistent with the specified frequency range of the radio. Recheck all antenna connections, and measure the reverse power again. If these checks/corrections fail to produce a reading within the range, replace the antenna and repeat the entire antenna test procedure. Any value exceeding the maximum allowable reflected power value will result in a diminished RF output signal. If problems persist, contact the Technical Assistance Center (see page 19).

13. Disconnect the coaxial cable jumper and wattmeter.
14. Permanently connect the cable from the vehicle-mounted antenna to the radio's antenna cable by mating the two TNC connectors together. Use two pairs of soft-jaw pliers to gently tighten this connection. Do not over-tighten and do not twist either cable.
15. Make several test calls to verify operation of the mobile radio. Before making each call, select talk group(s) or conventional channel(s) designated for making radio test calls on the respective radio system.

**NOTE**

To prevent RF leakage and ensure peak performance, make sure the antenna cable's RF connector at the rear of the radio is tight. Do not over-tighten it, since this may cause connector damage.

**WARNING**

Improper installation of the RF cables may lead not only to poor radio performance, but also to harmful exposure to RF electromagnetic energy.

Testing is complete. The radio is now ready for normal communications.

15.6 TEST PERFORMANCE DATA FORM

Clip  Here

Enter the information requested on this data collection form. Clip this form and file it as a permanent record of the tested performance of the M5300/M7300 mobile radio installation.

Mobile Radio Serial Number

Antenna Make and Model Numbers

*Date of Test
(mm/dd/yyyy)*

Company Performing Installation

Technician Performing Test



Watts
<i>Power into a Dummy Load</i>

Watts
<i>Forward Power with Antenna</i>

Watts
<i>Reflected Power with Antenna</i>

16 COMPLETE THE INSTALLATION

Double-check the following items before considering the installation completed:

- Verify all newly installed mechanical hardware is mounted securely and all respective mounting hardware is tight.
- Verify all electrical interconnections are connected properly and the associated connector attachment hardware is tight. Pay special attention to all RF antenna cables!
- Verify all related fuses are correctly installed and properly rated.
- Verify all electrical cables and wiring are tied, stowed, and protected so they are out of the way of casual contact, away from sources of extreme heat, and wire chafing cannot occur. Pay special attention to all RF antenna cables!
- To prevent fumes from entering the vehicle's passenger compartment, seal the hole/grommet/wire combination at the firewall with a silicon-based sealer.
- Verify all vehicle components are properly reinstalled such as kick panels, headliners, and seats.
- If the installation includes a separately-mounted on/off power switch for manually turning the radio (and possibly others systems) on and off, verify it is labelled accordingly. For example: "**Radio ON/OFF.**"
- Remove all tools and unused hardware from the vehicle.
- Verify the test performance data has been recorded on the data collection form shown in this manual.

17 WARRANTY

- A. Harris Corporation, a Delaware Corporation, through its Public Safety and Professional Communications (PS&PC) Division (hereinafter "Seller") warrants to the original purchaser for use (hereinafter "Buyer") that Equipment manufactured by or for the Seller shall be free from defects in material and workmanship, and shall conform to its published specifications. With respect to all non-Seller Equipment, Seller gives no warranty, and only the warranty, if any, given by the manufacturer shall apply. Rechargeable batteries are excluded from this warranty but are warranted under a separate Rechargeable Battery Warranty (ECR-7048).
- B. Seller's obligations set forth in Paragraph C below shall apply only to failures to meet the above warranties occurring within the following periods of time from date of sale to the Buyer and are conditioned on Buyer's giving written notice to Seller within thirty (30) days of such occurrence:
1. for fuses and non-rechargeable batteries, operable on arrival only.
 2. for parts and accessories (except as noted in B.1) sold by Seller's Service Parts Operation, ninety (90) days.
 3. for P7200, P7100^{IP}, P5400, P5300, P5200, P5100, P3300, PANTHER™ 405P and 605P, M7300, M7200 (including V-TAC), M7100^{IP}, M5300 and M3300 radios, two (2) years, effective 10/01/2007.
 4. for all other equipment of Seller's manufacture, one (1) year.
- C. If any Equipment fails to meet the foregoing warranties, Seller shall correct the failure at its option (i) by repairing any defective or damaged part or parts thereof, (ii) by making available at Seller's factory any necessary repaired or replacement parts, or (iii) by replacing the failed Equipment with equivalent new or refurbished Equipment. Any repaired or replacement part furnished hereunder shall be warranted for the remainder of the warranty period of the Equipment in which it is installed. Where such failure cannot be corrected by Seller's reasonable efforts, the parties will negotiate an equitable adjustment in price. Labor to perform warranty service will be provided at no charge during the warranty period only for the Equipment covered under Paragraph B.3 and B.4. To be eligible for no-charge labor, service must be performed at Seller's factory, by an Authorized Service Center (ASC) or other Servicer approved for these purposes either at its place of business during normal business hours, for mobile or personal equipment, or at the Buyer's location, for fixed location equipment. Service on fixed location equipment more than thirty (30) miles from the Service Center or other approved Servicer's place of business will include a charge for transportation.
- D. Seller's obligations under Paragraph C shall not apply to any Equipment, or part thereof, which (i) has been modified or otherwise altered other than pursuant to Seller's written instructions or written approval or, (ii) is normally consumed in operation or, (iii) has a normal life inherently shorter than the warranty periods specified in Paragraph B, or (iv) is not properly stored, installed, used, maintained or repaired, or, (v) has been subjected to any other kind of misuse or detrimental exposure, or has been involved in an accident.
- E. The preceding paragraphs set forth the exclusive remedies for claims based upon defects in or nonconformity of the Equipment, whether the claim is in contract, warranty, tort (including negligence), strict liability or otherwise, and however instituted. Upon the expiration of the warranty period, all such liability shall terminate. The foregoing warranties are exclusive and in lieu of all other warranties, whether oral, written, expressed, implied or statutory. **NO IMPLIED OR STATUTORY WARRANTIES OF MERCHANTABILITY OR FITNESS FOR PARTICULAR PURPOSE SHALL APPLY. IN NO EVENT SHALL THE SELLER BE LIABLE FOR ANY INCIDENTAL, CONSEQUENTIAL, SPECIAL, INDIRECT OR EXEMPLARY DAMAGES.**

This warranty applies only within the United States.

Harris Corporation
PS&PC Division
221 Jefferson Ridge Parkway
Lynchburg, VA 24501
1-800-528-7711



Public Safety and Professional Communications | www.harrispublicsafety.com
221 Jefferson Ridge Parkway | Lynchburg, VA USA 24501 | 1-800-528-7711