

1

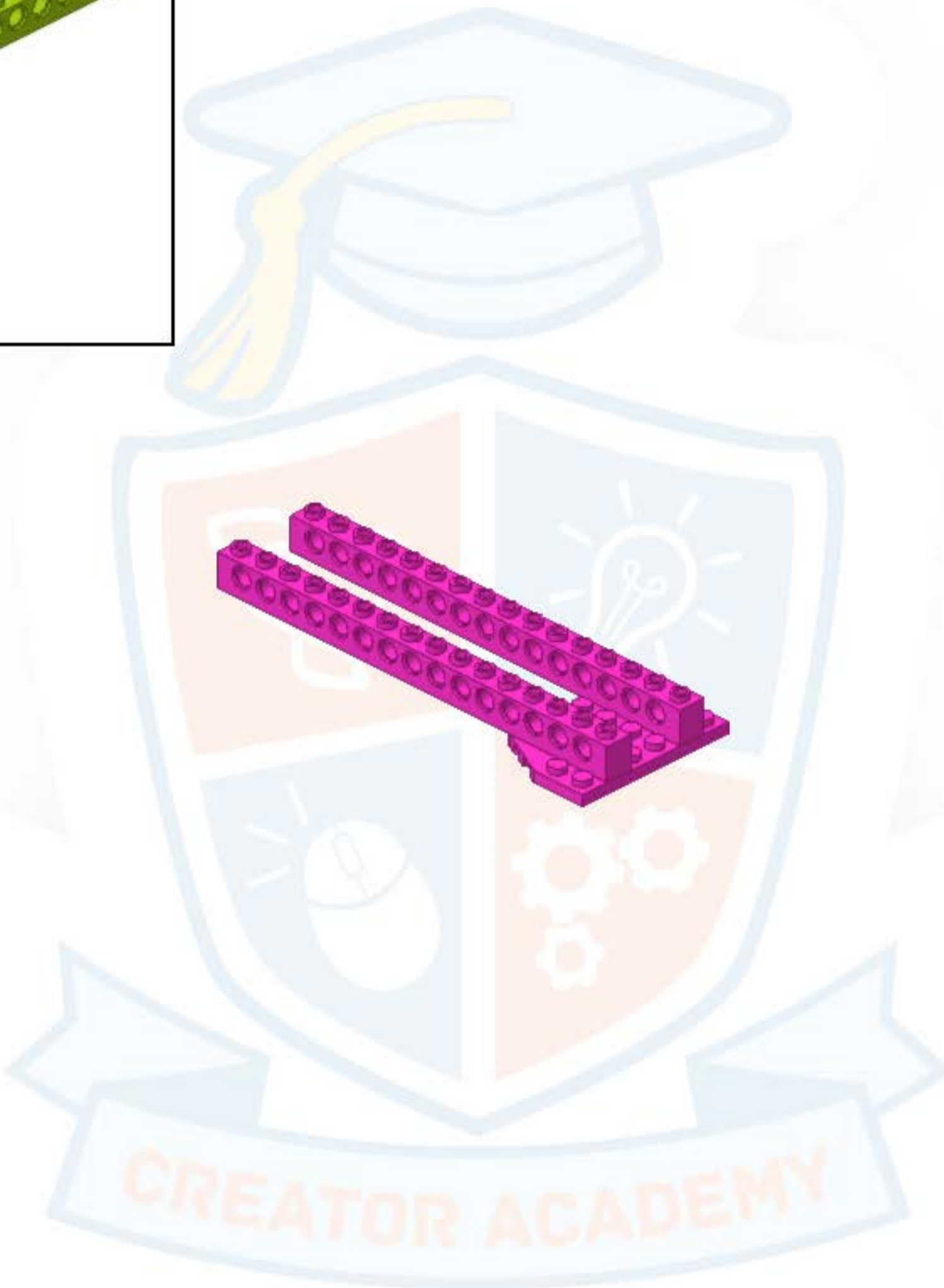

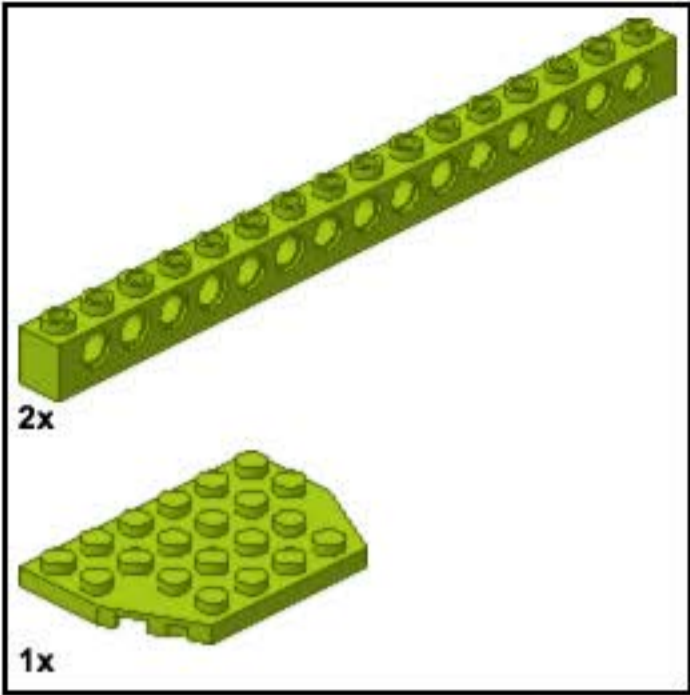

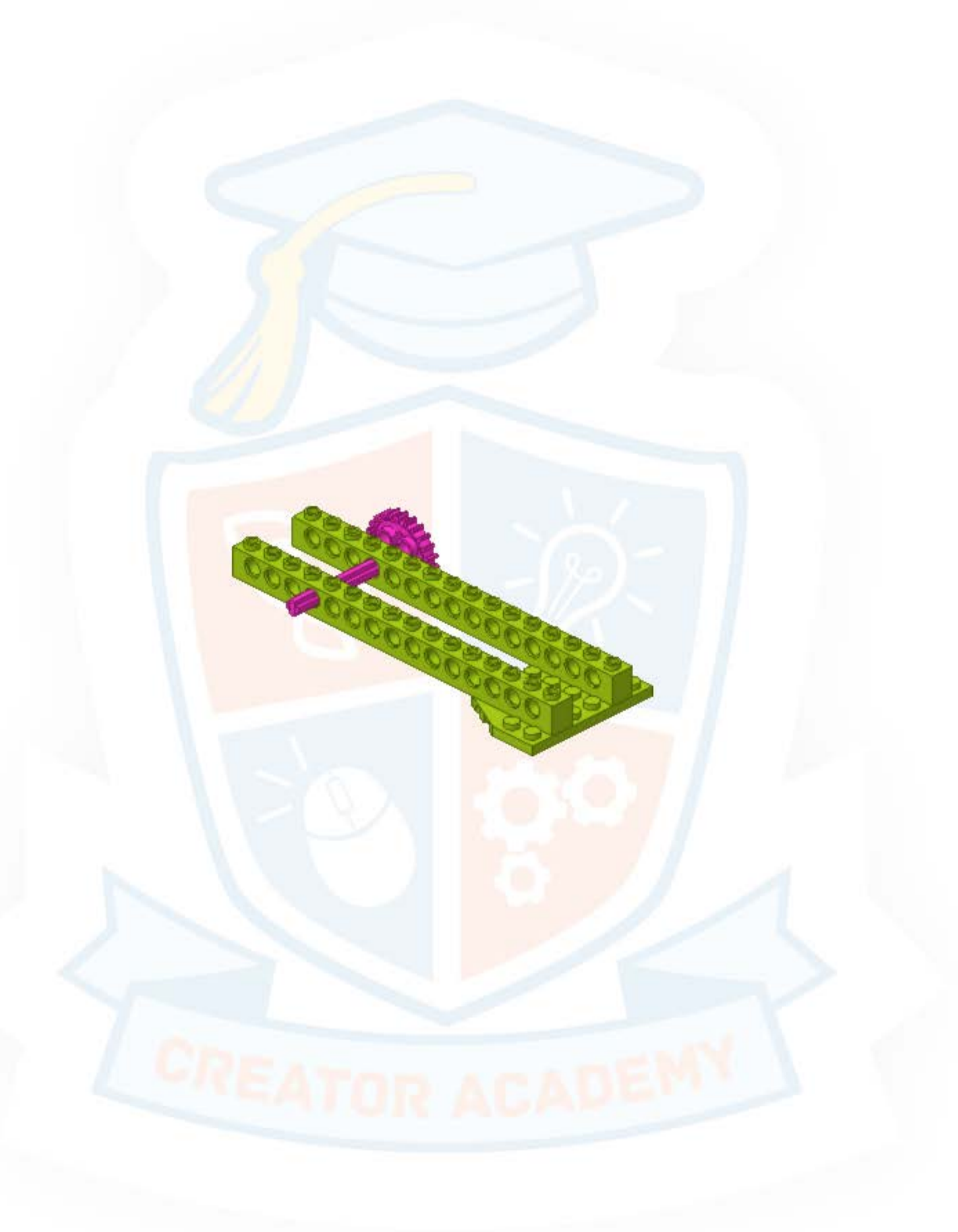

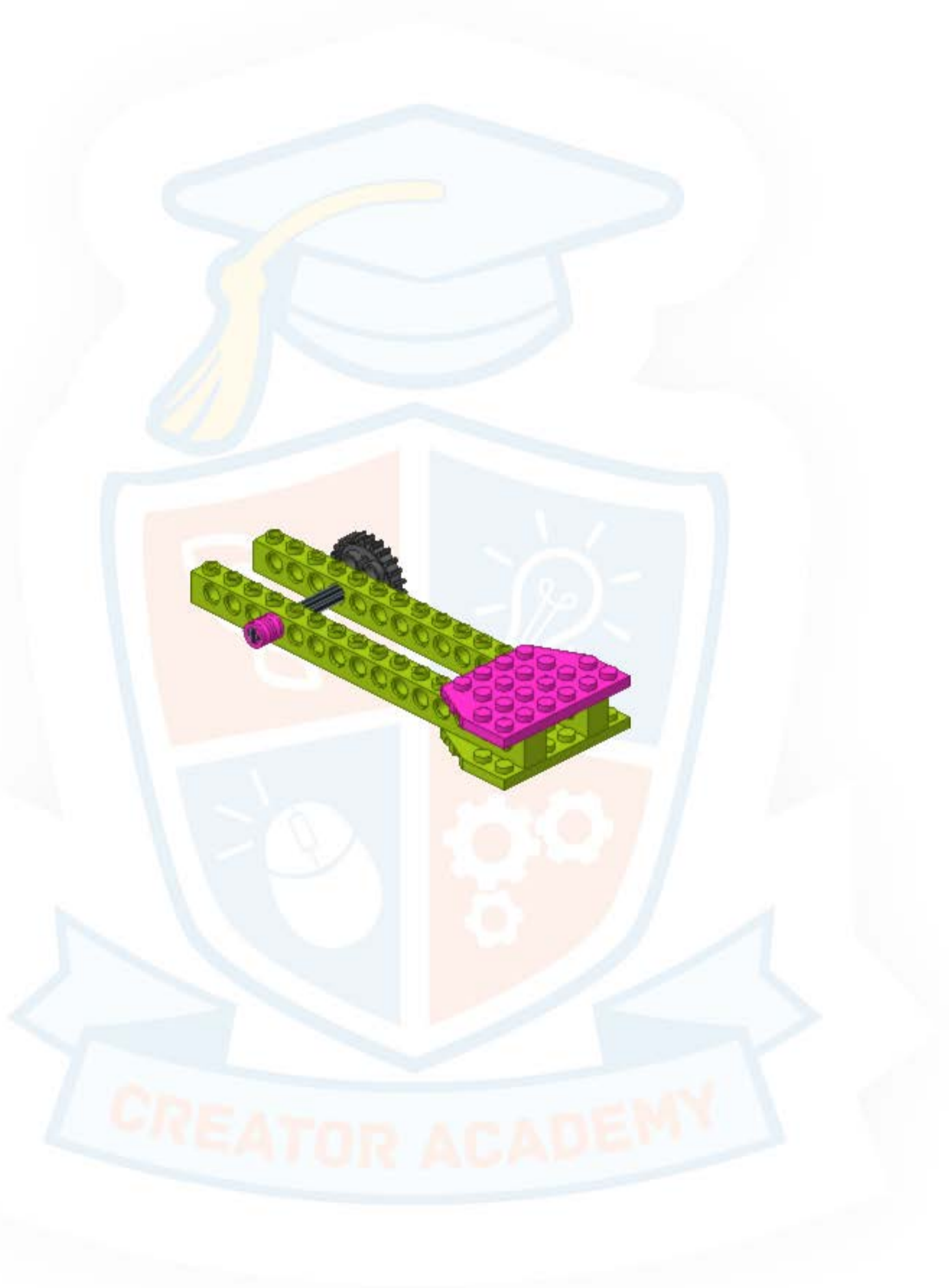
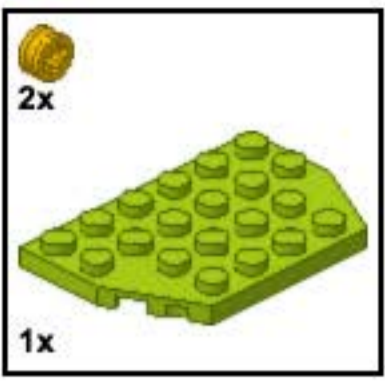
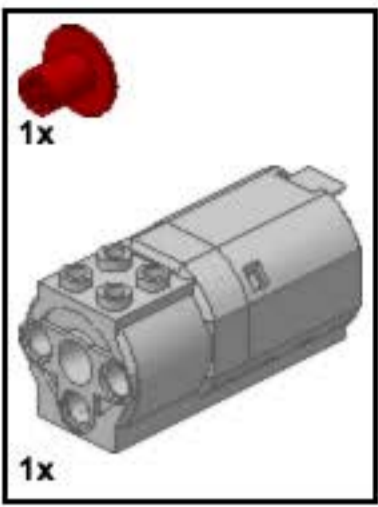

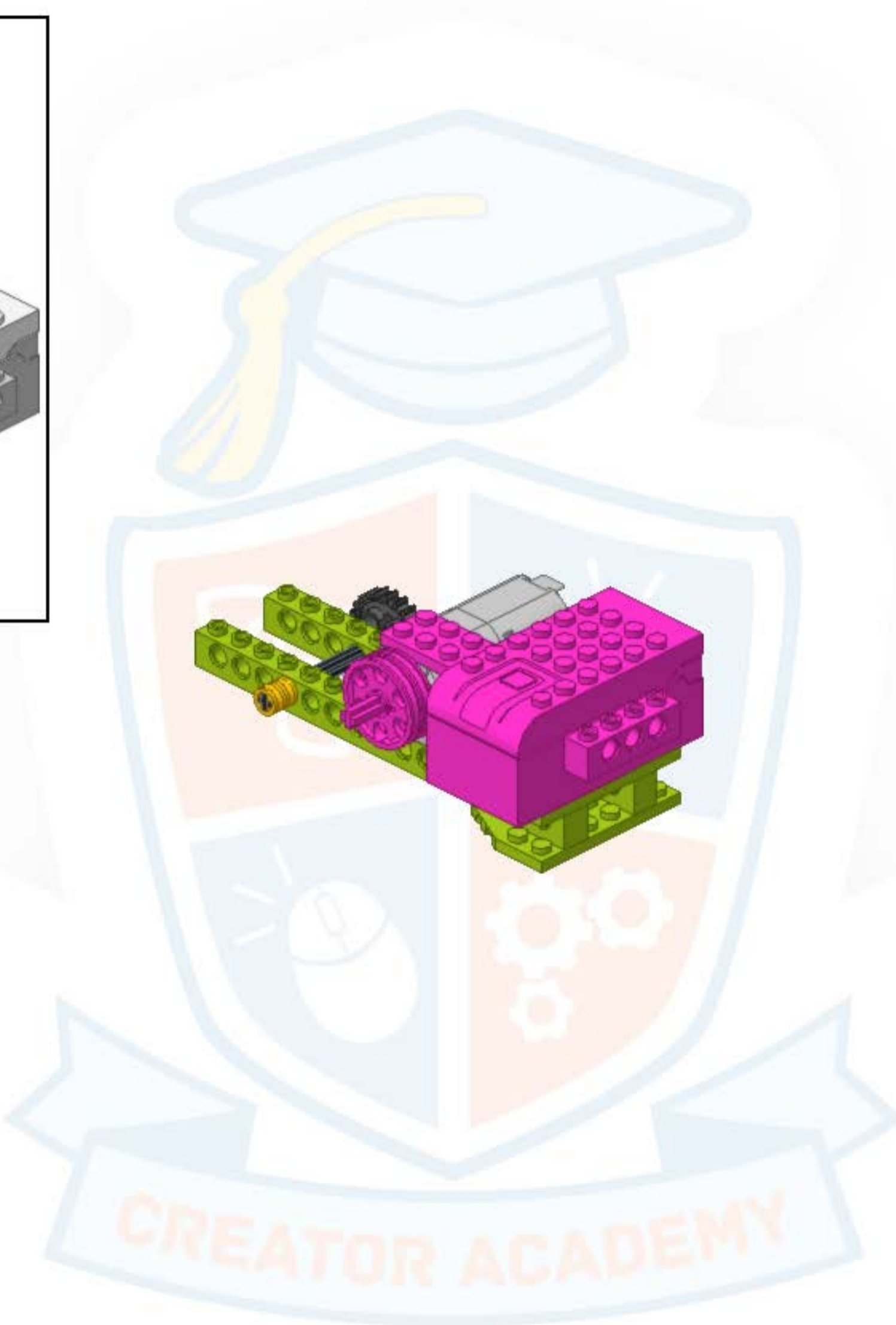
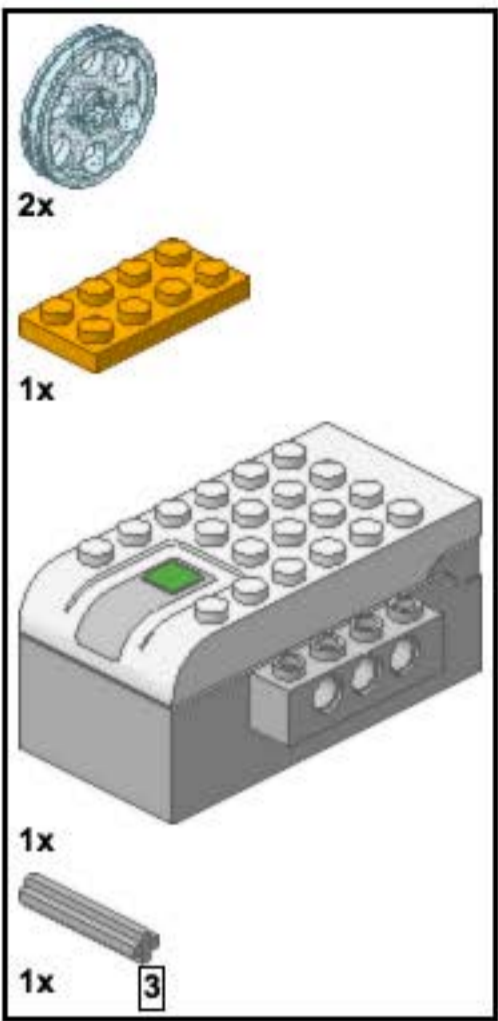

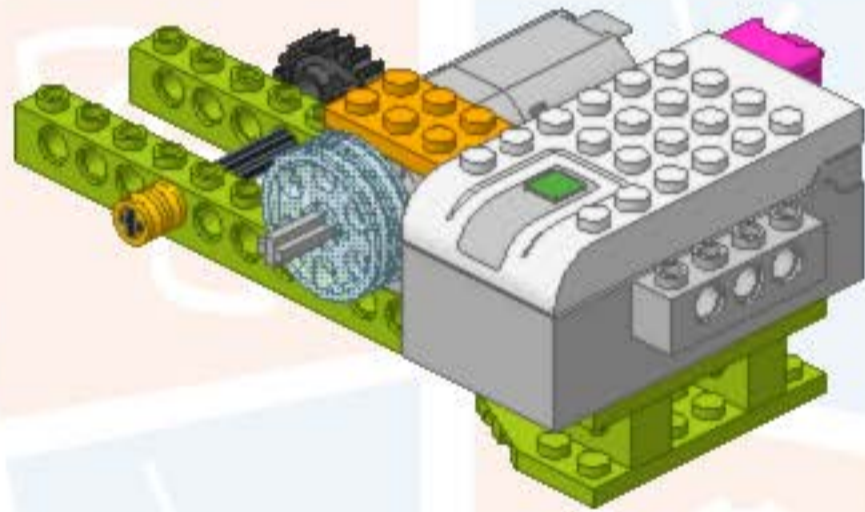
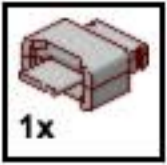

LOOP 2X RED RUBBER BANDS

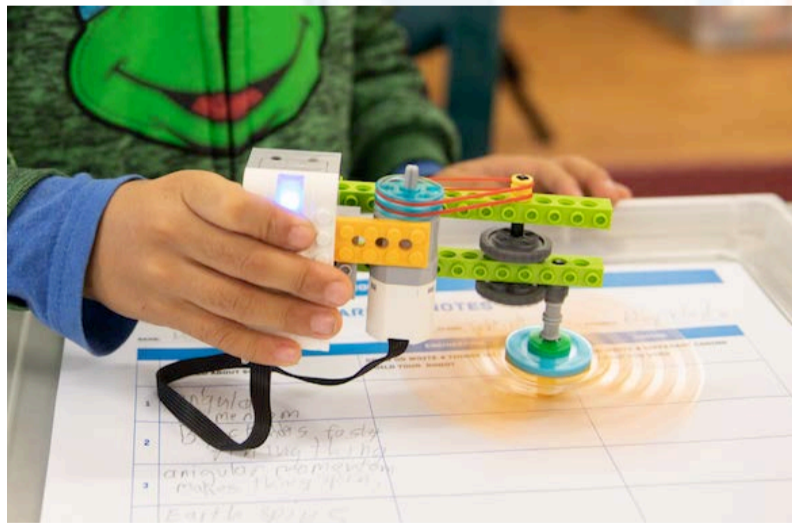

1

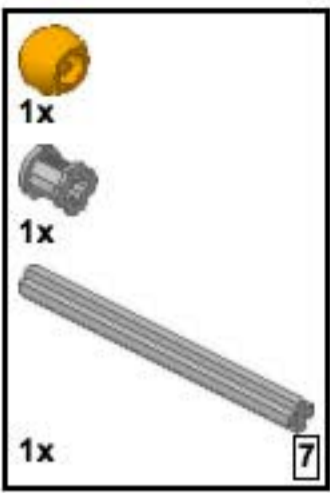

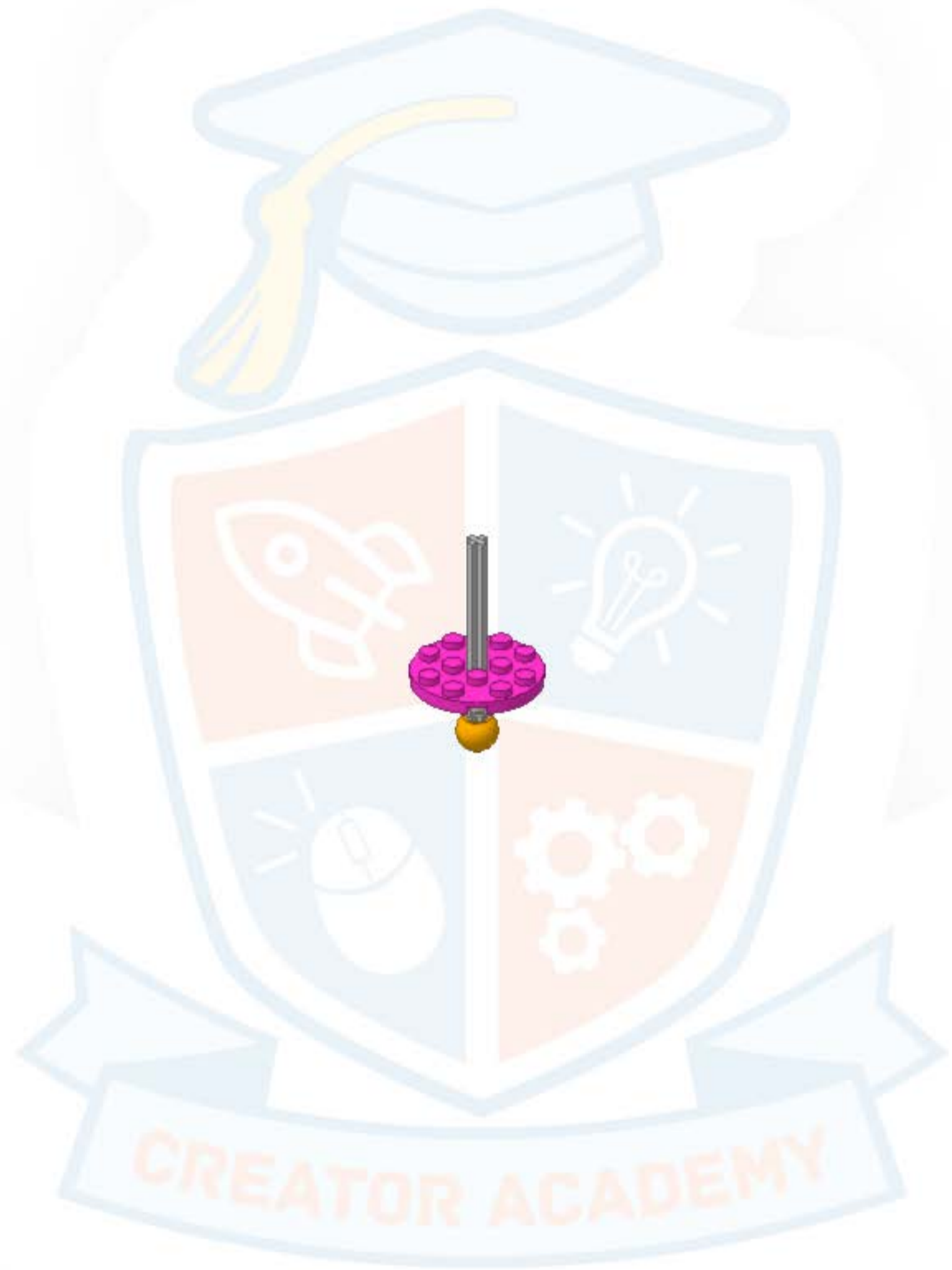
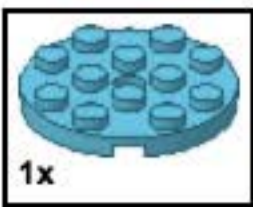

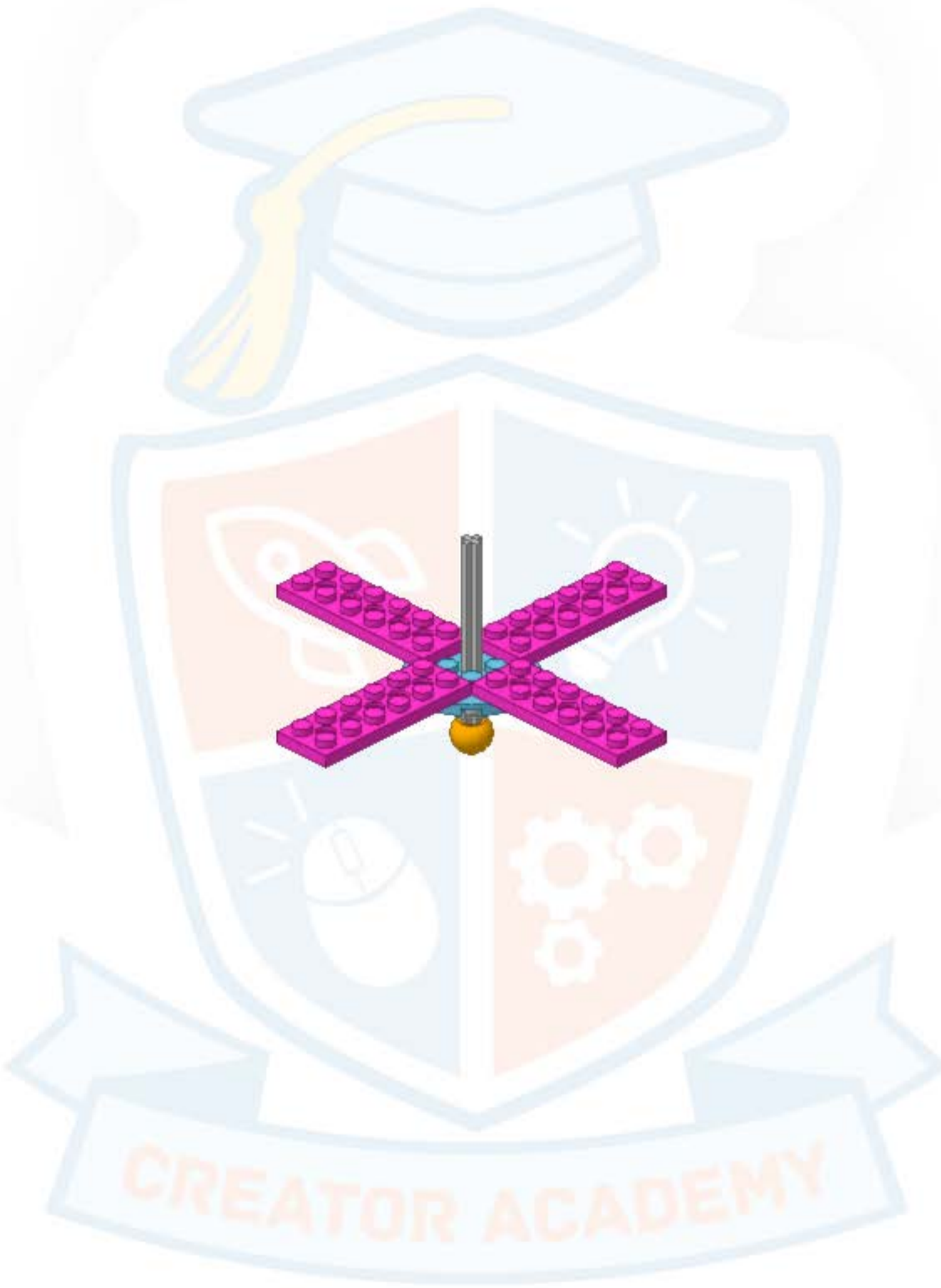
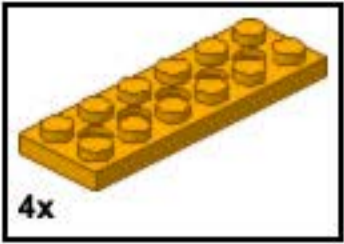

3

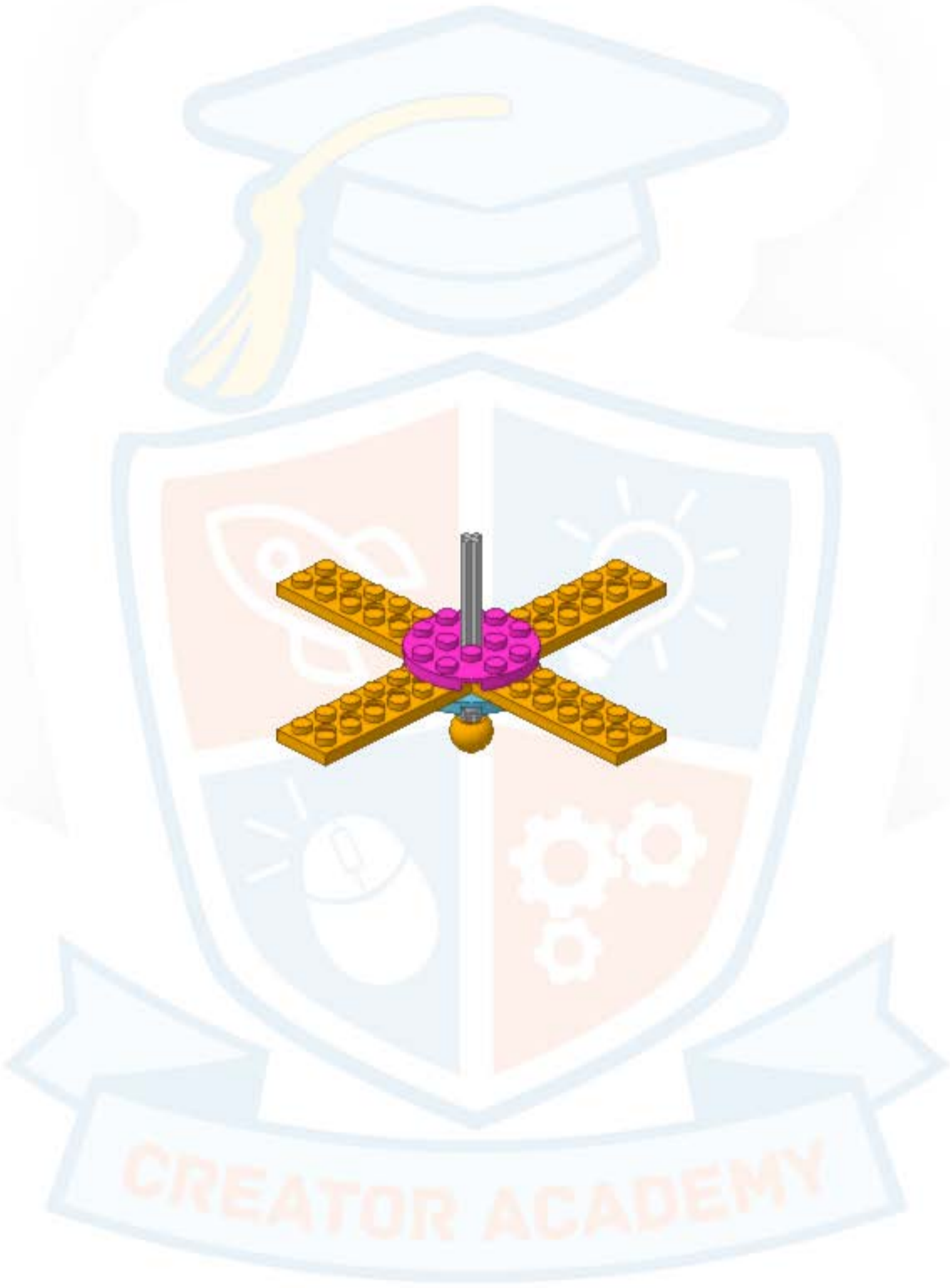
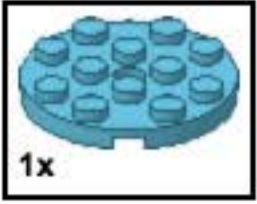

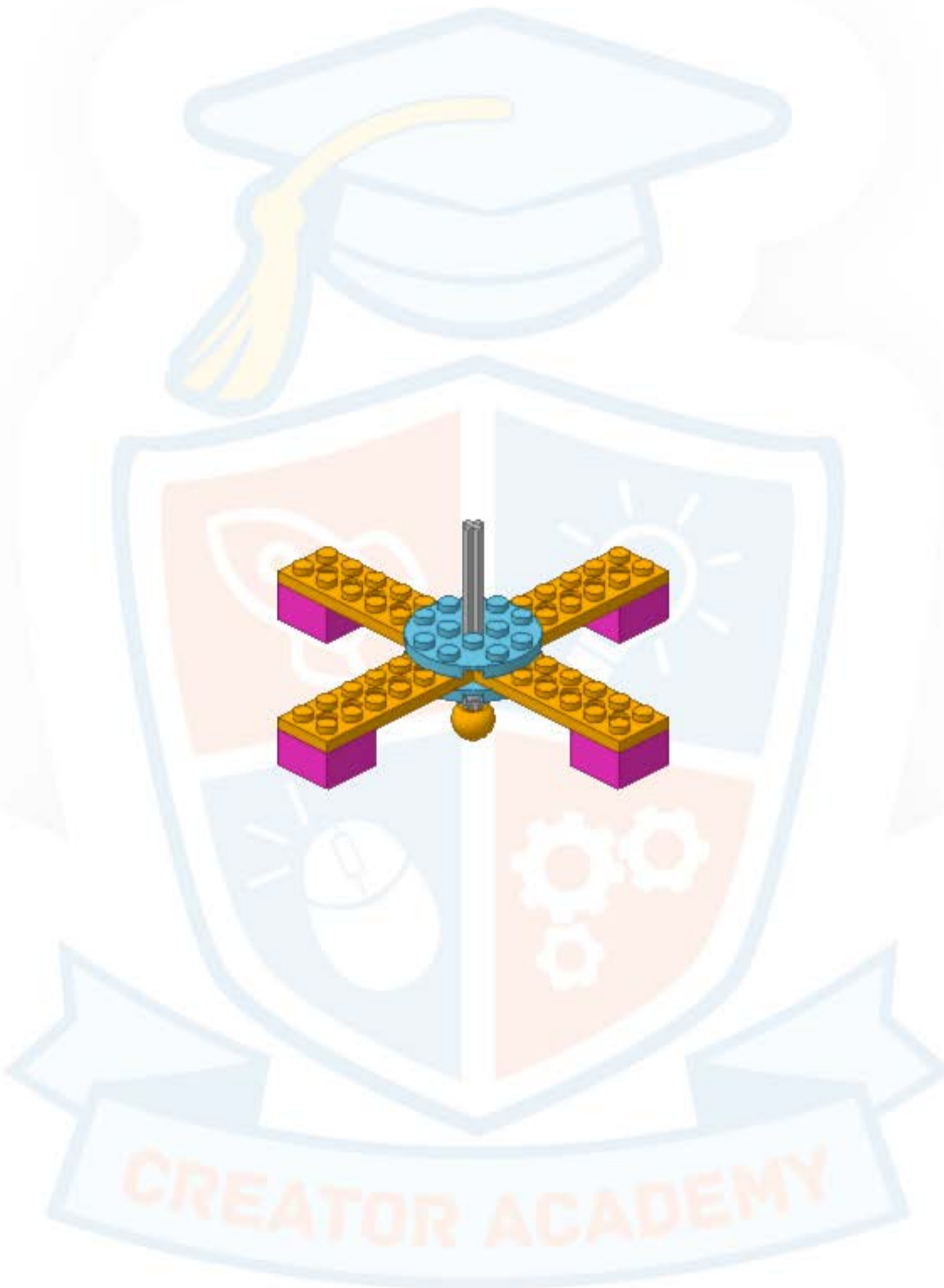



- 1x 
- 1x 
- 1x 