

1

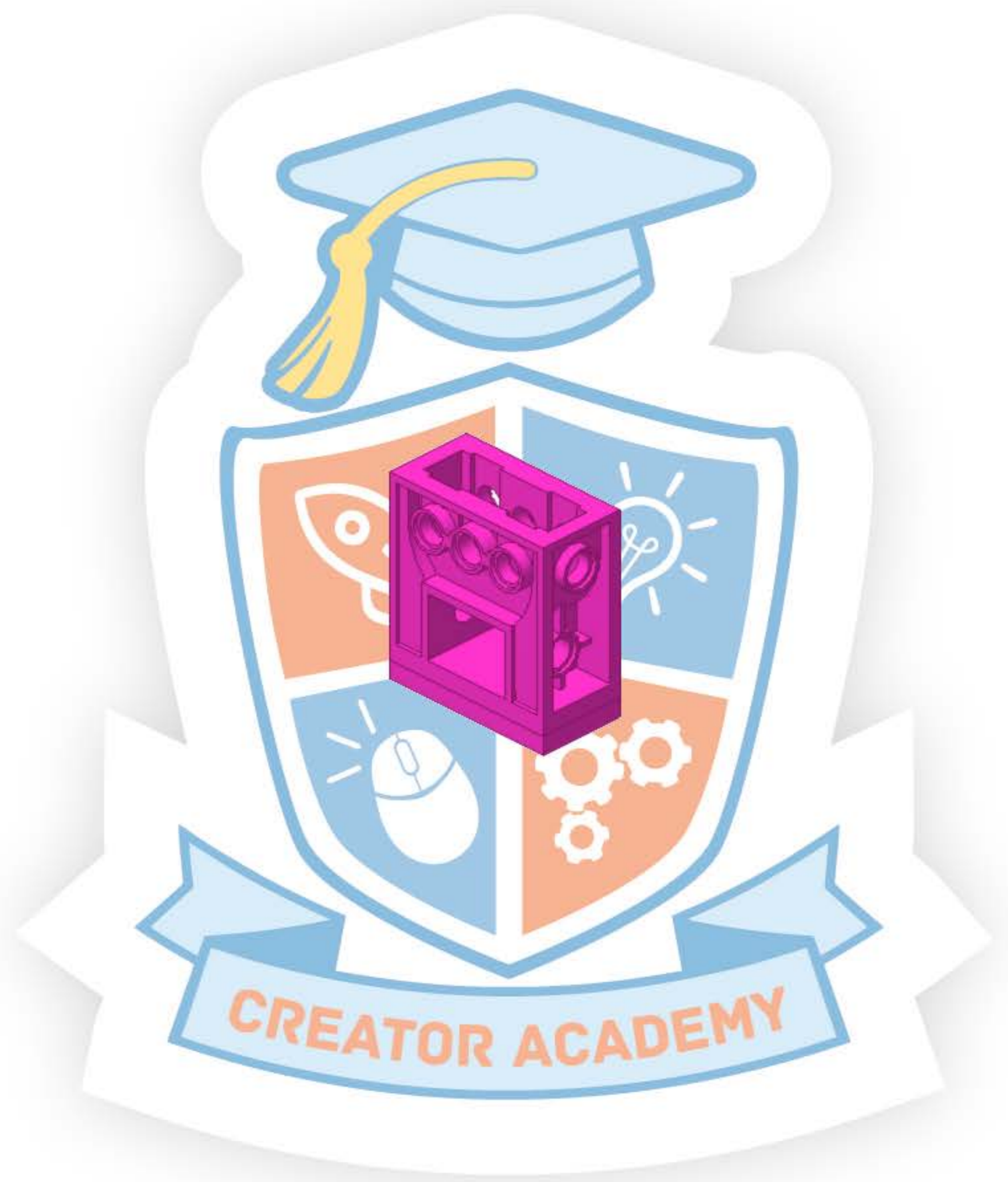

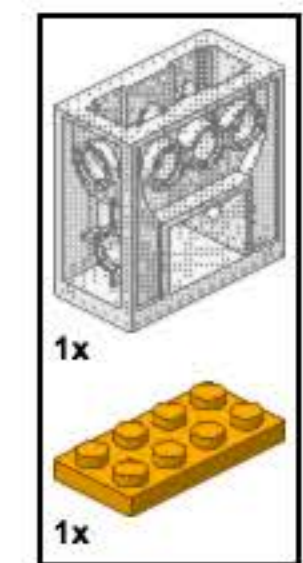

3

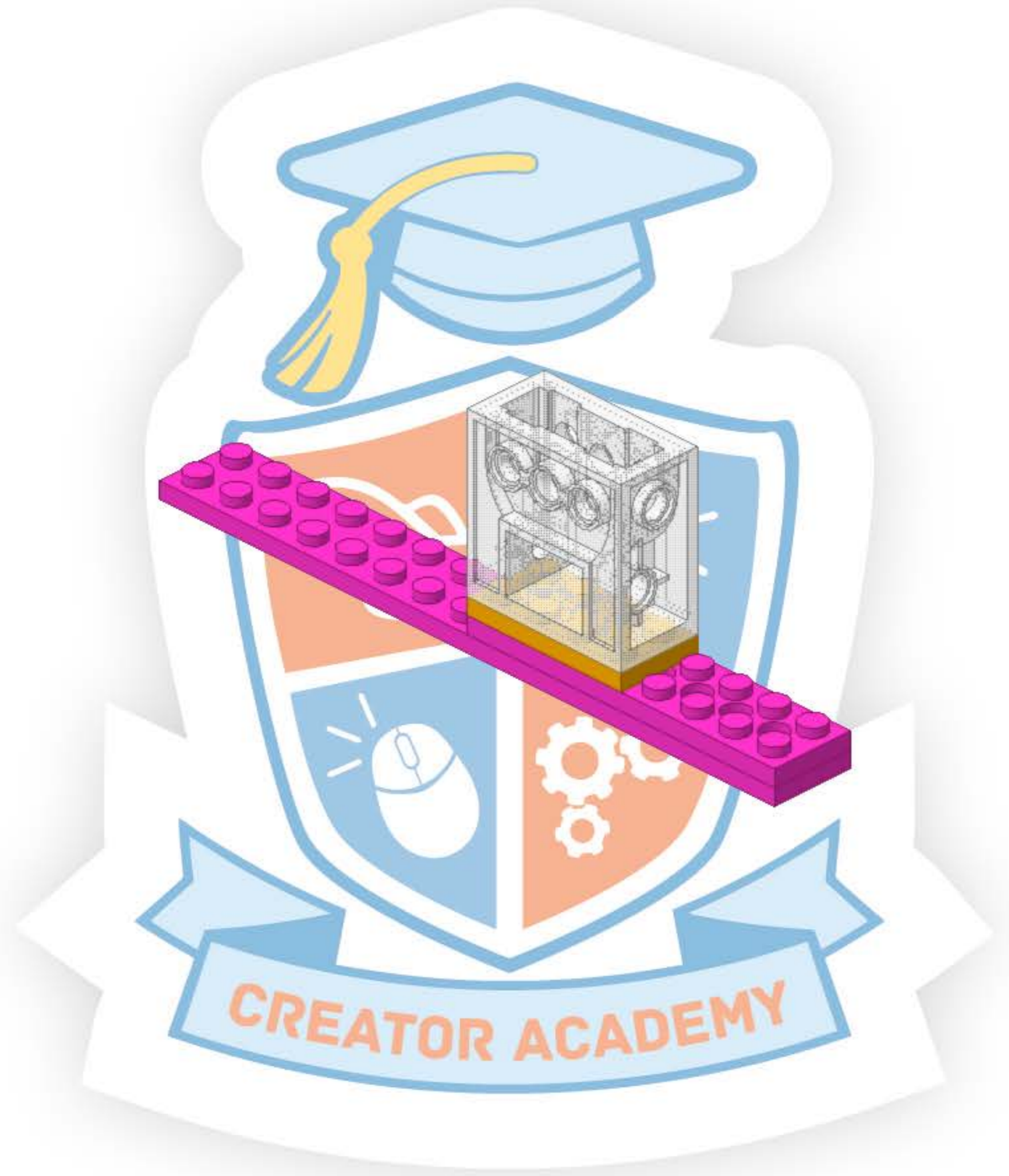
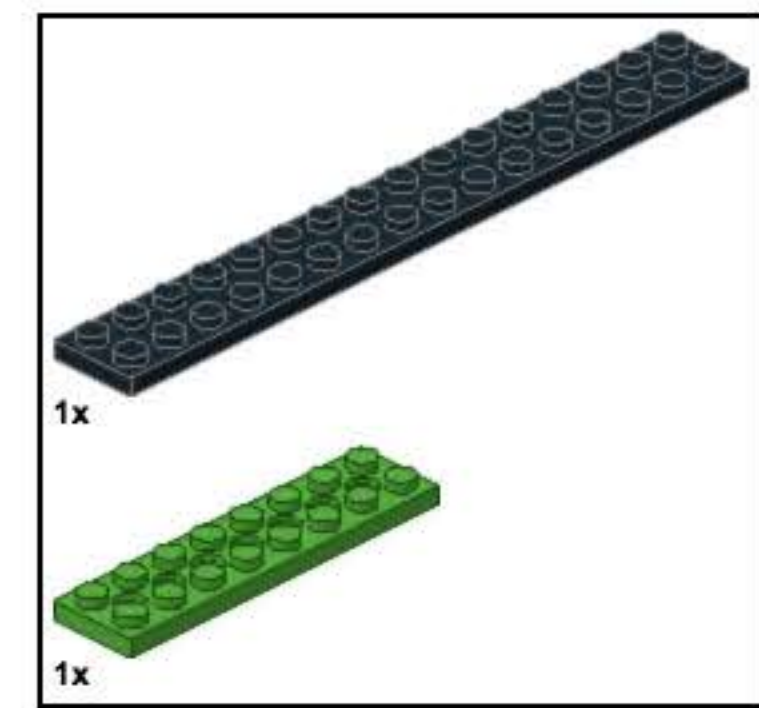
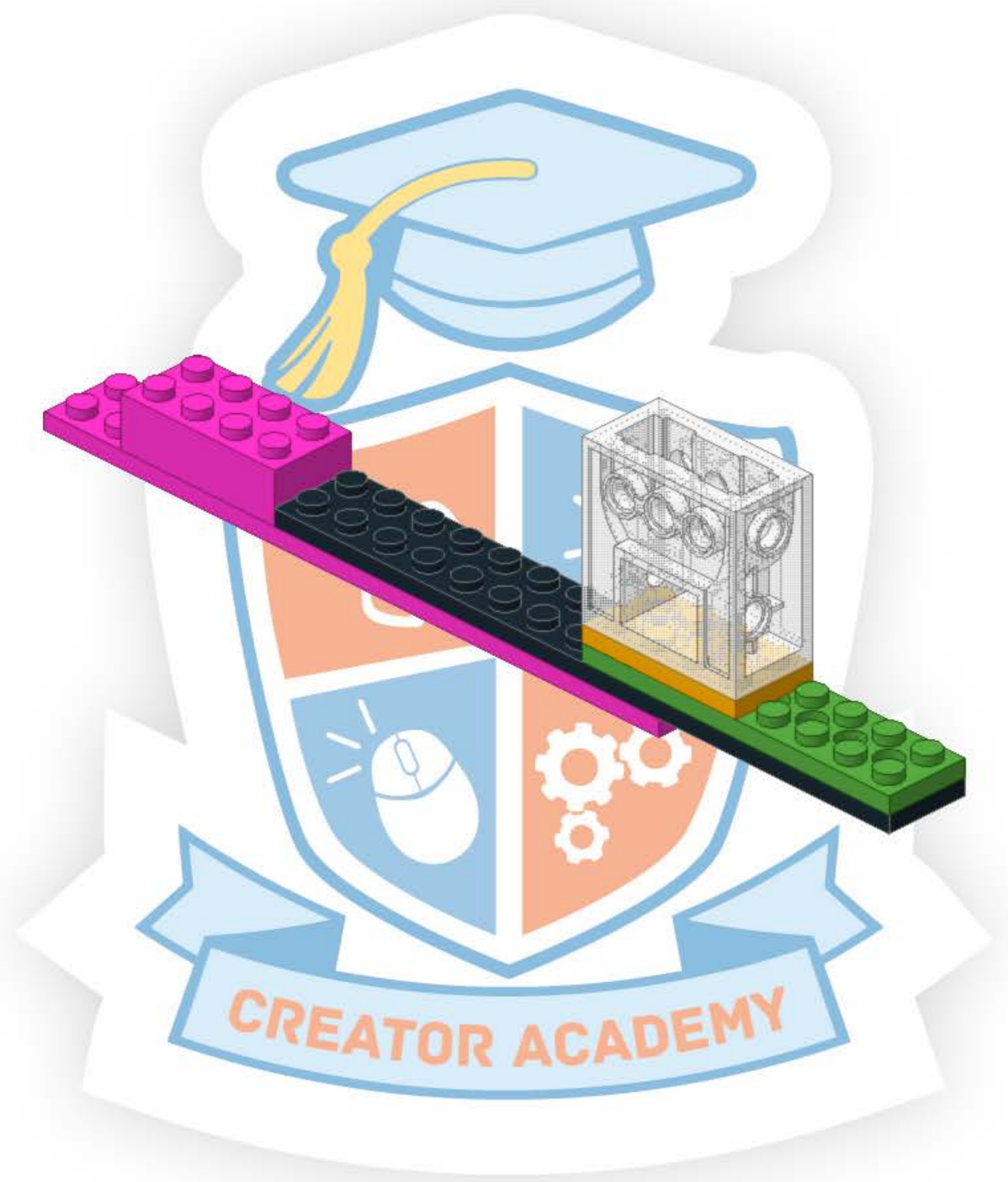
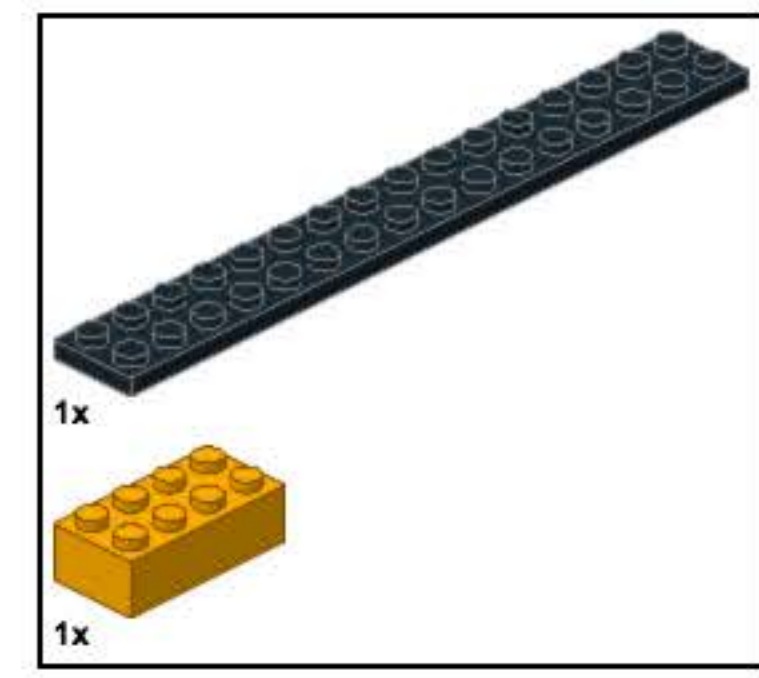

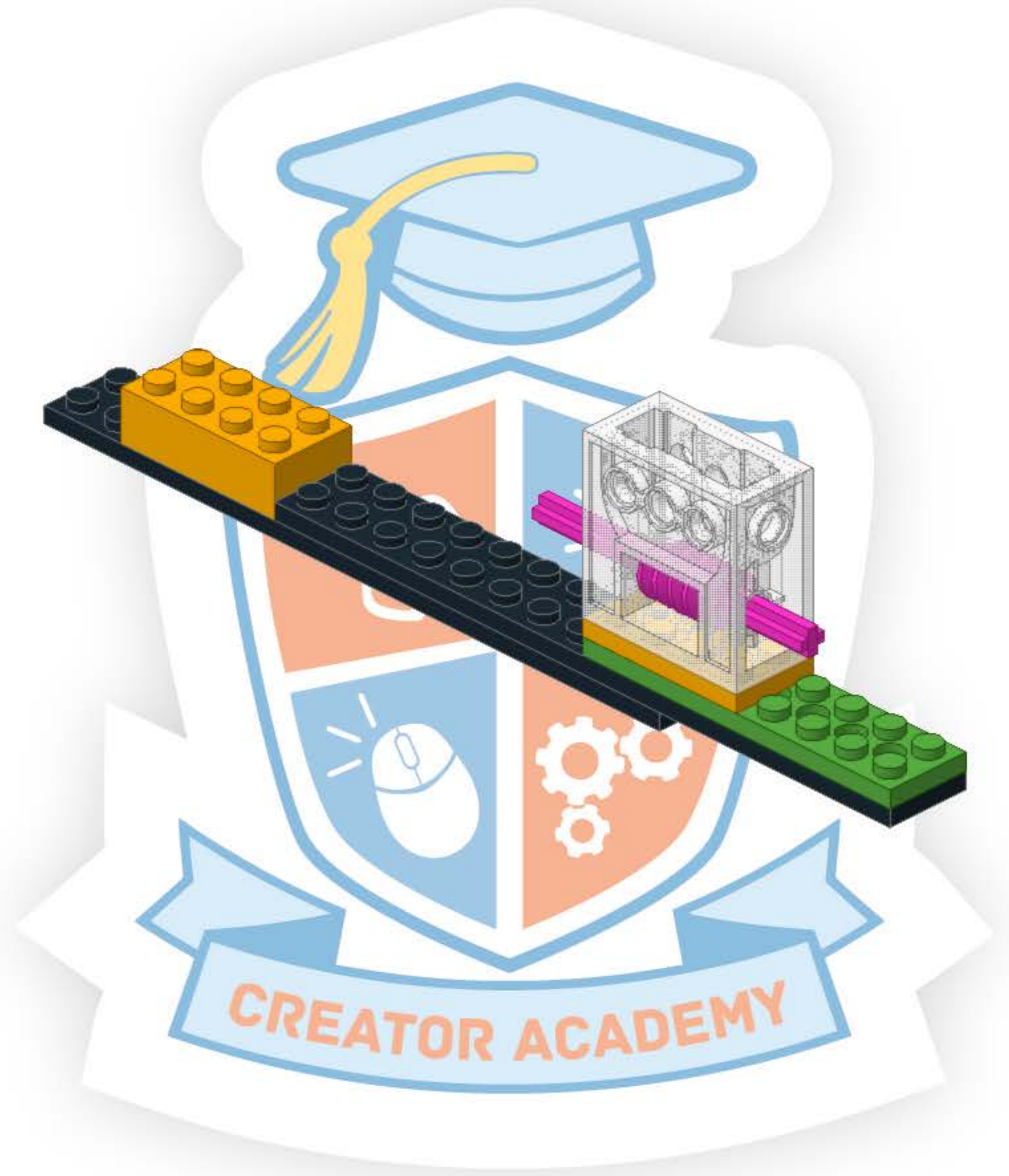

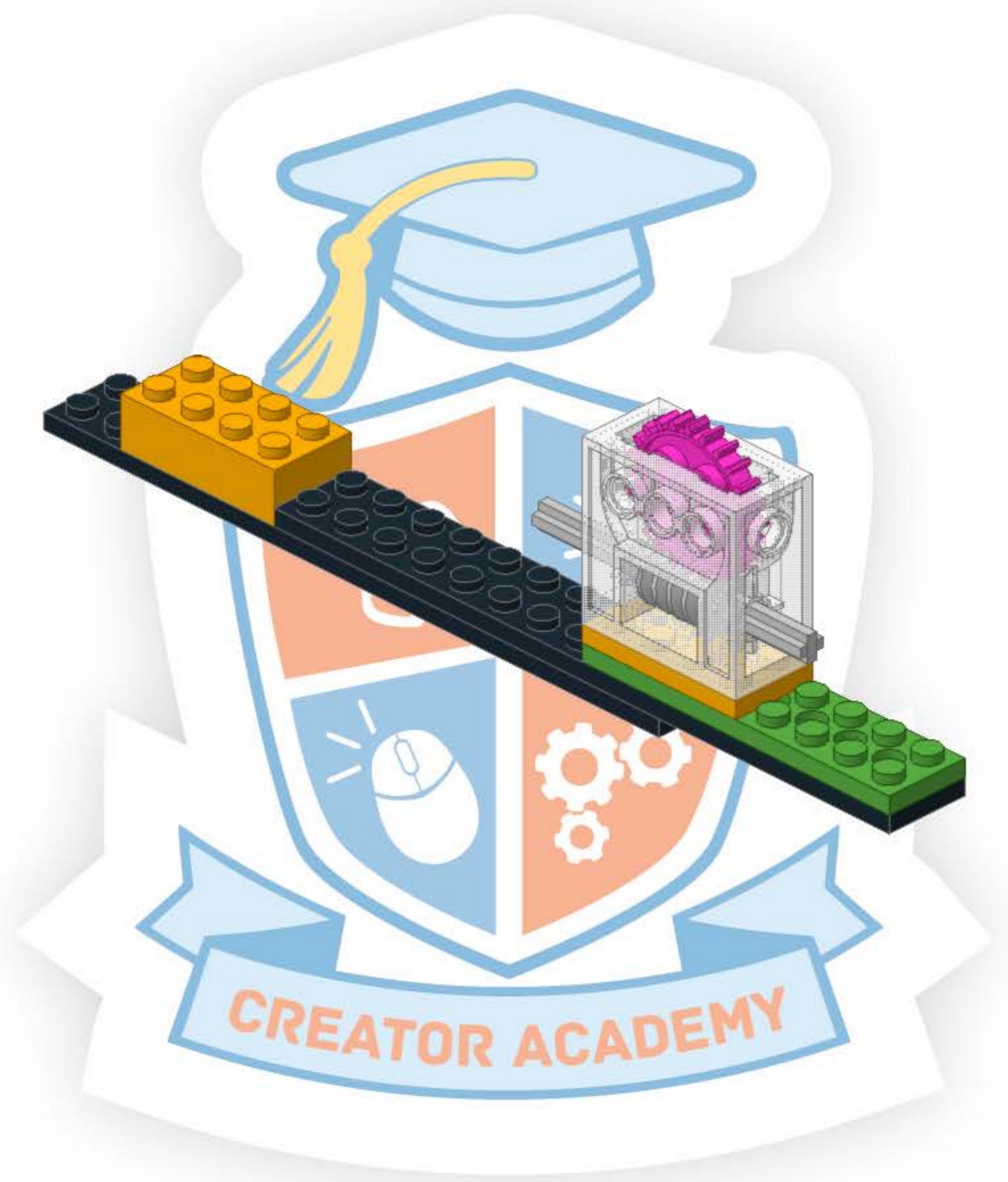

6

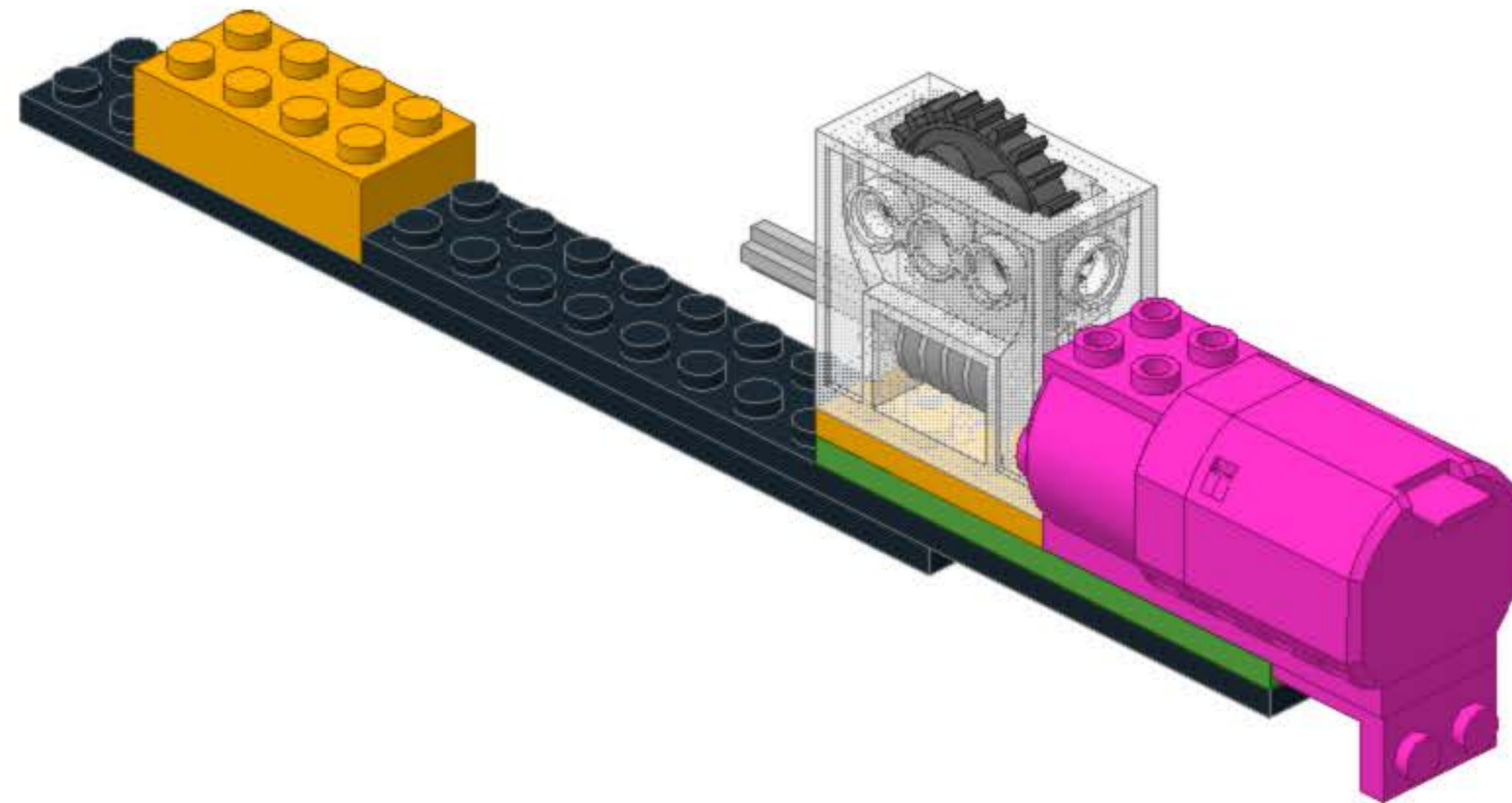
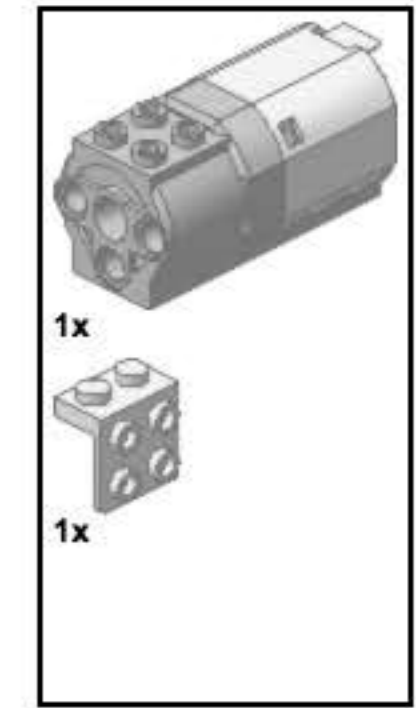

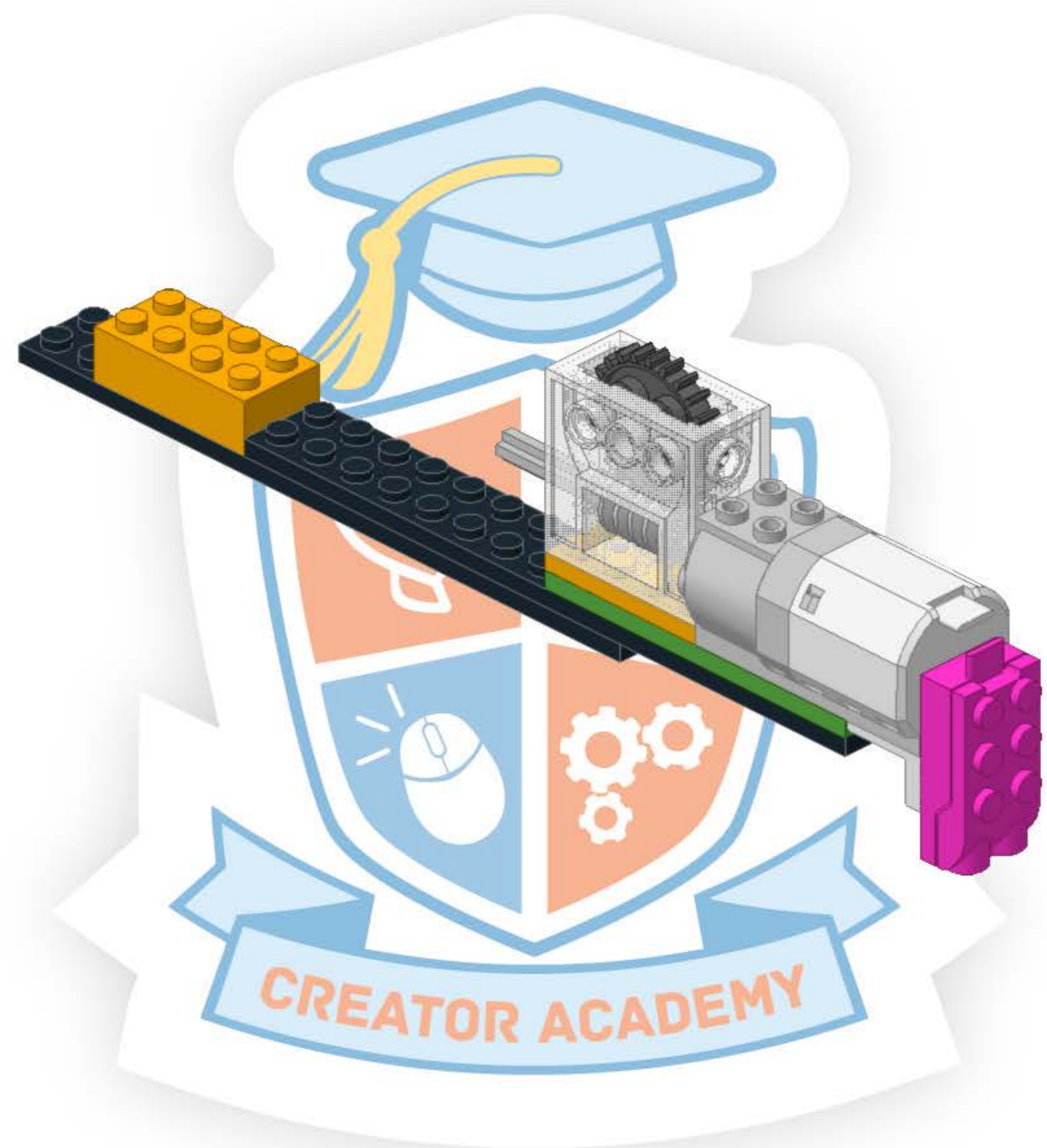
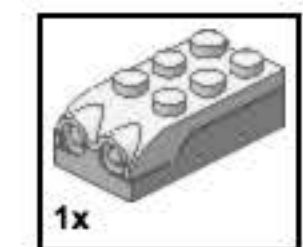

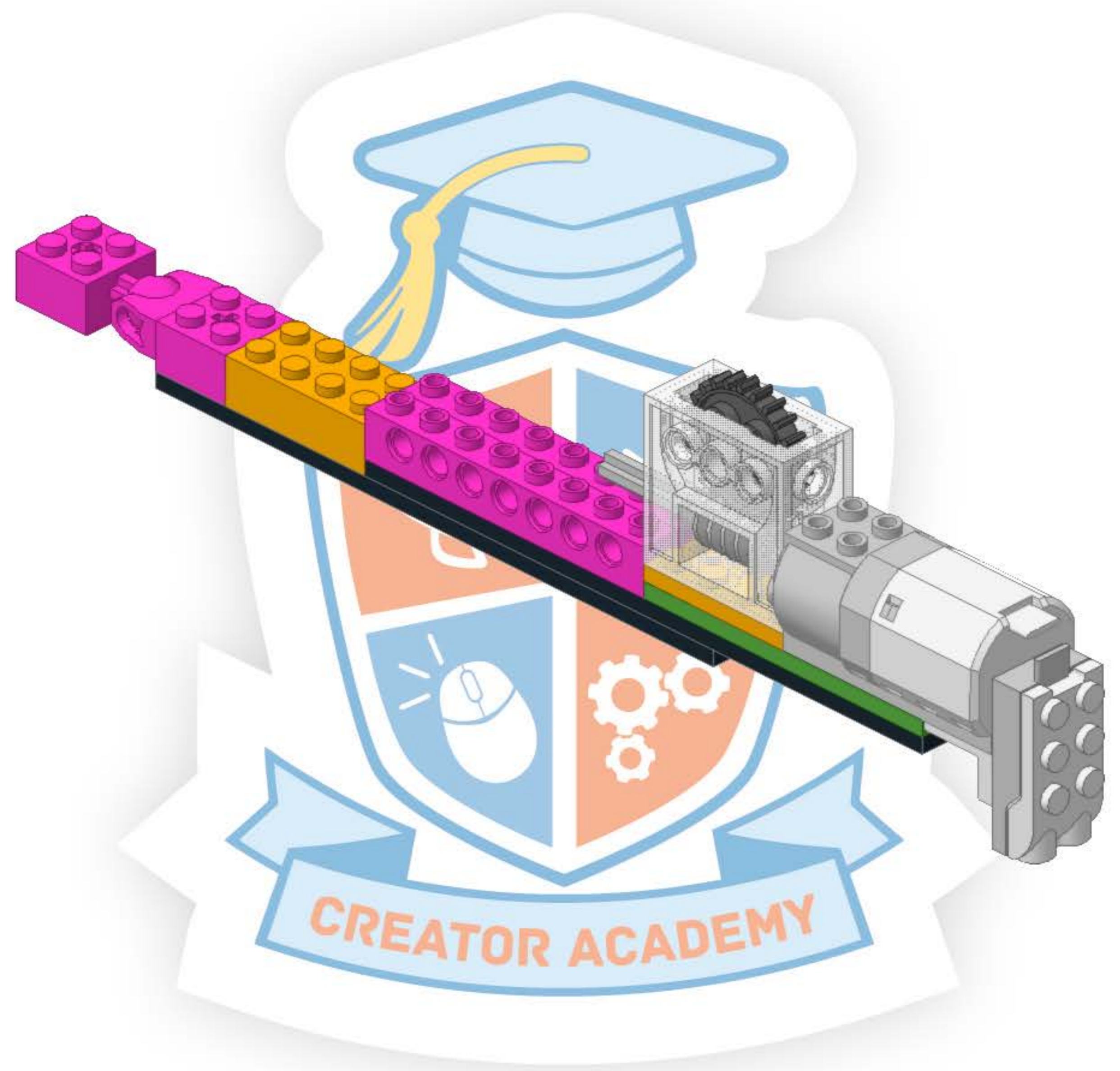
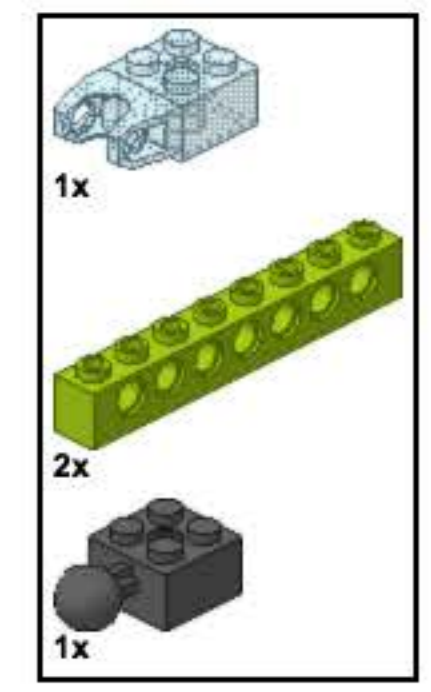





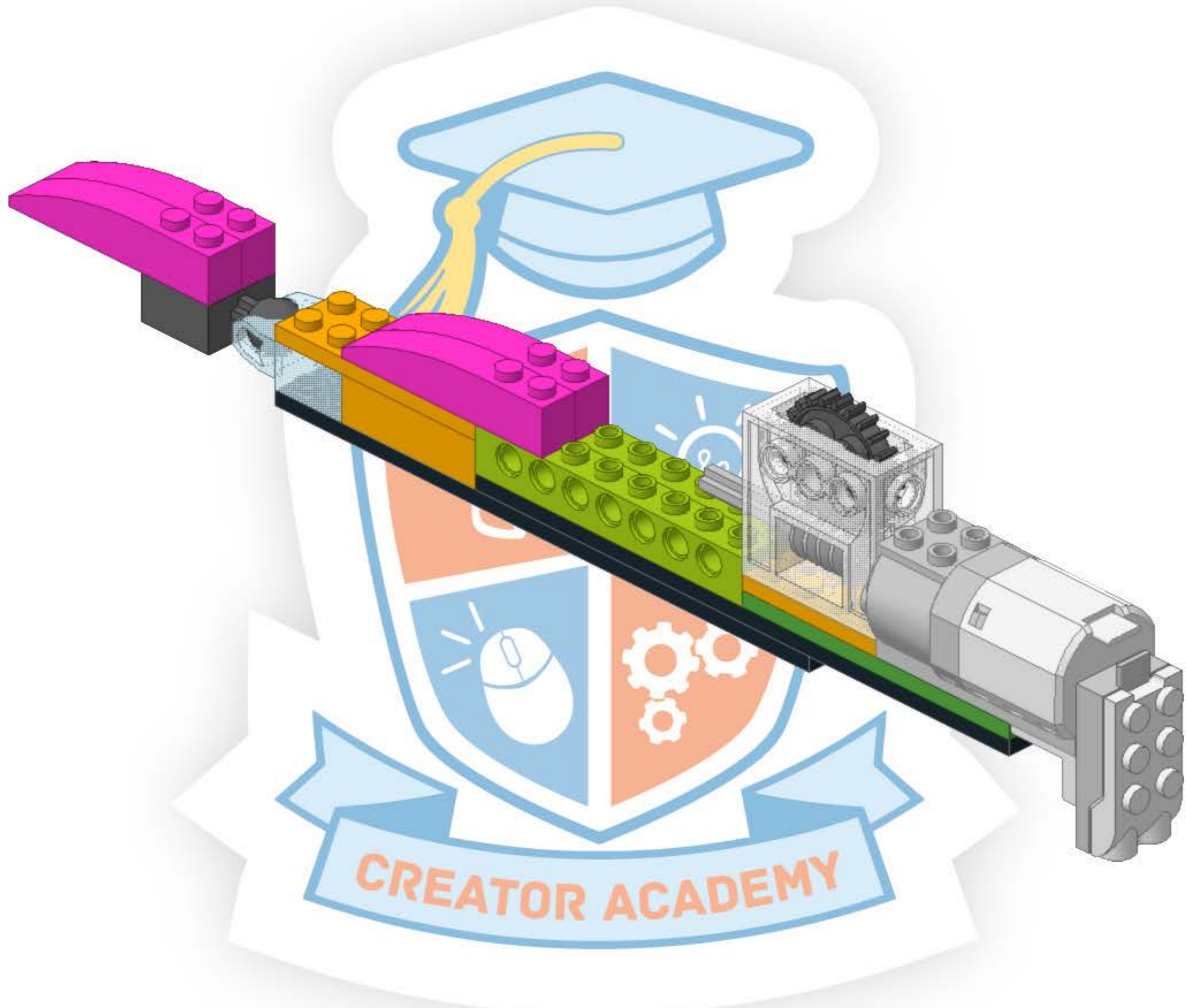
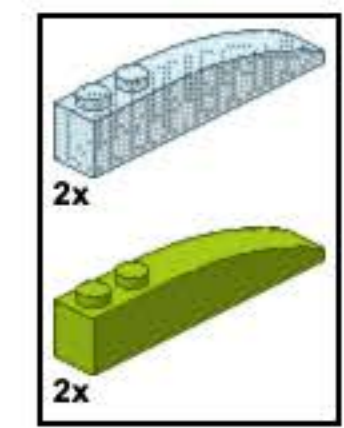

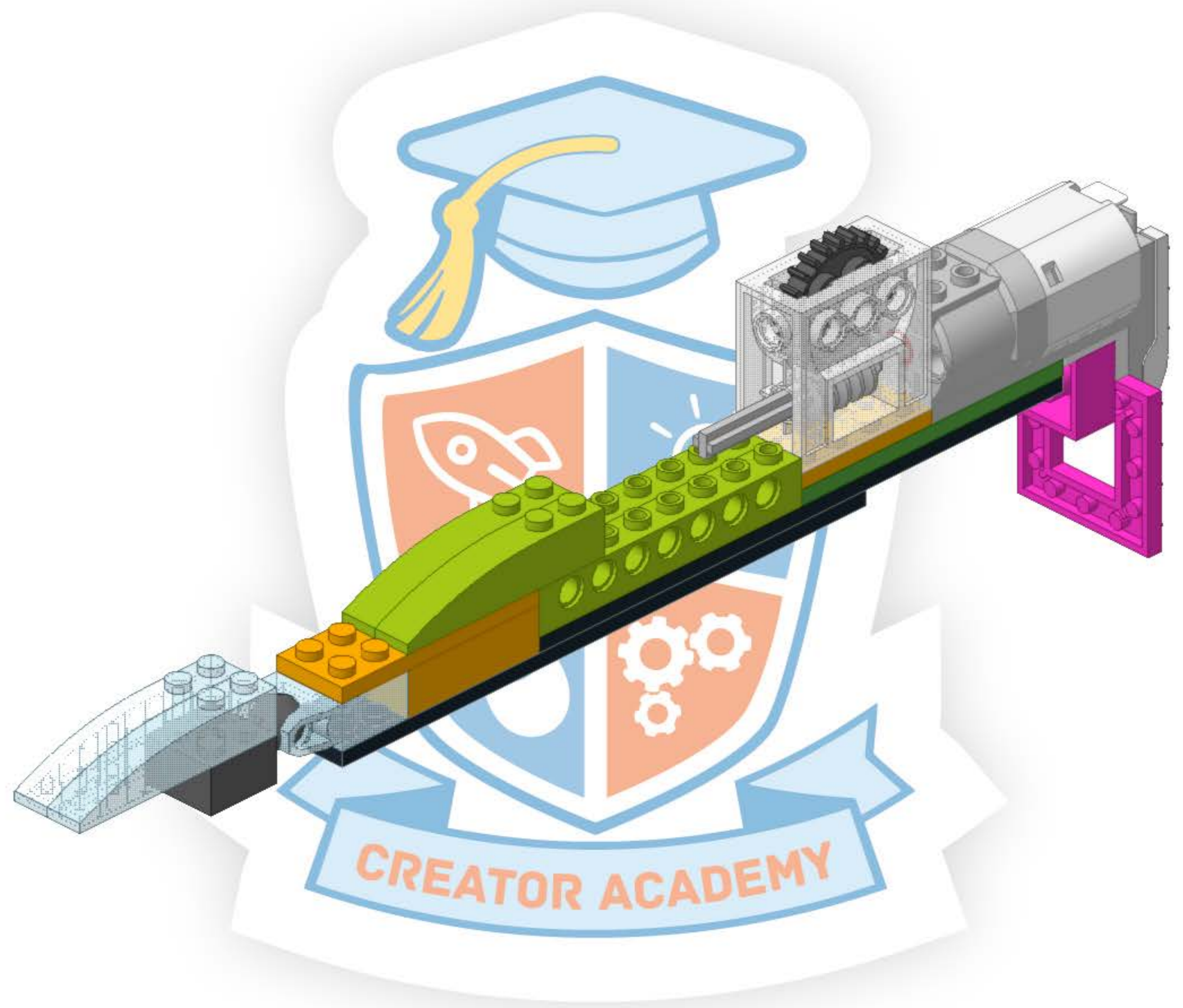
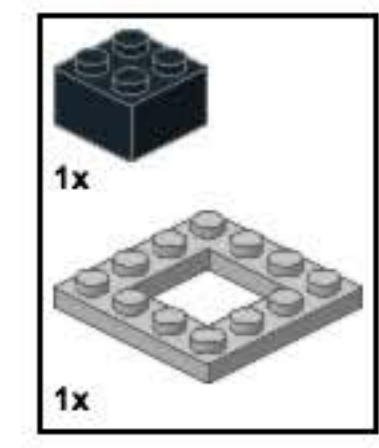

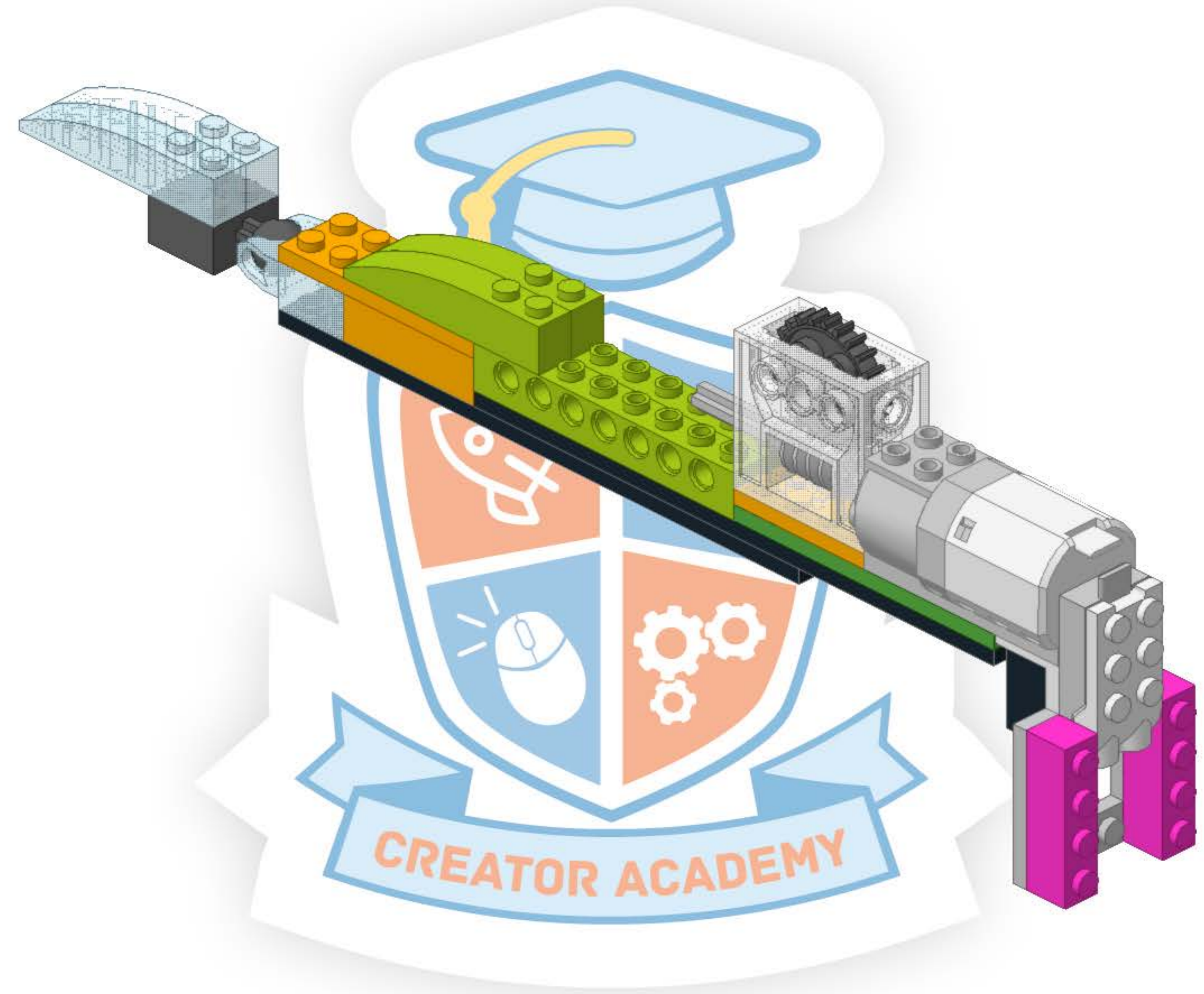
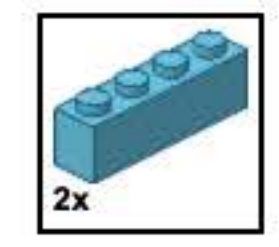

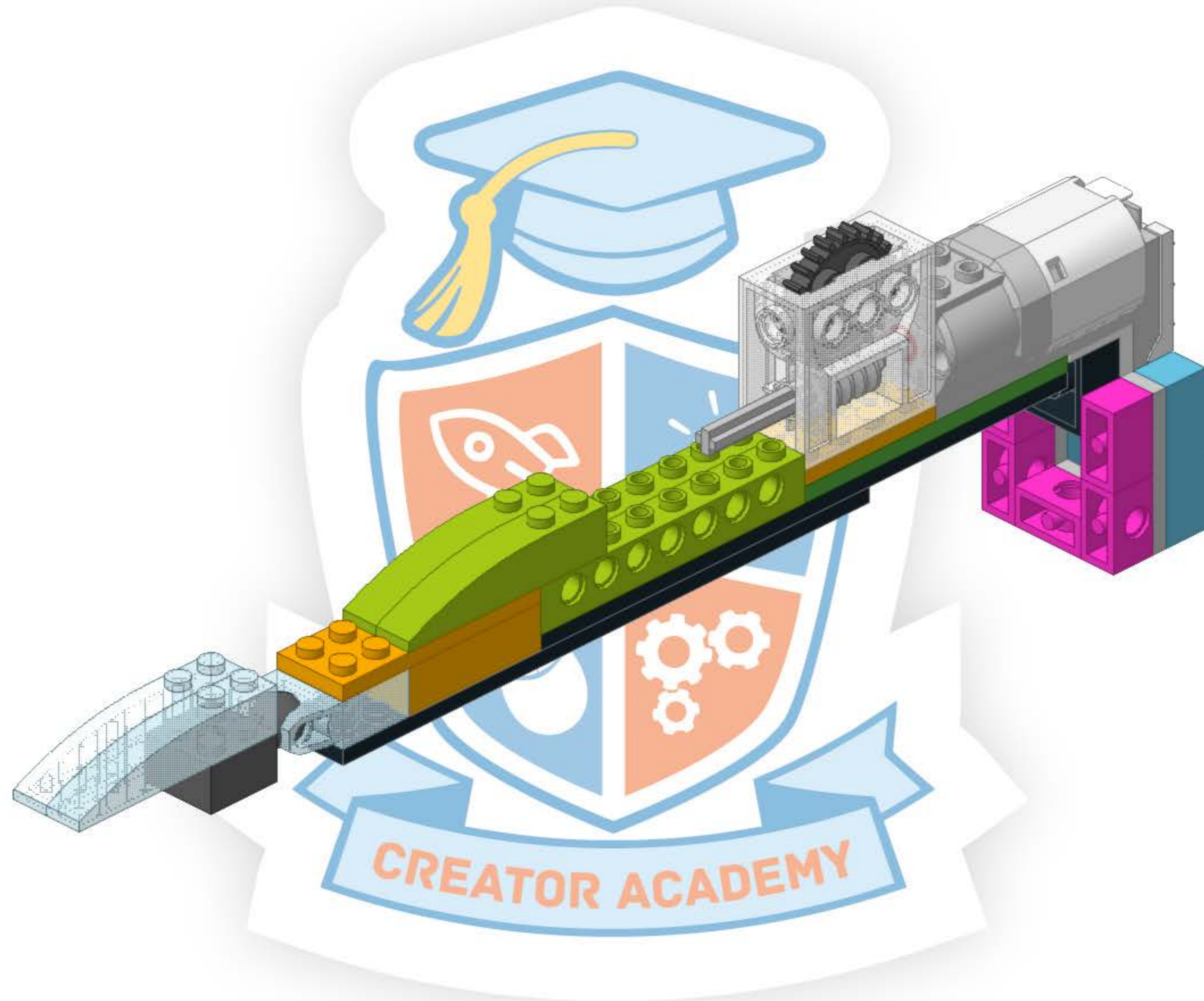
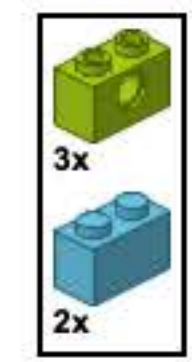



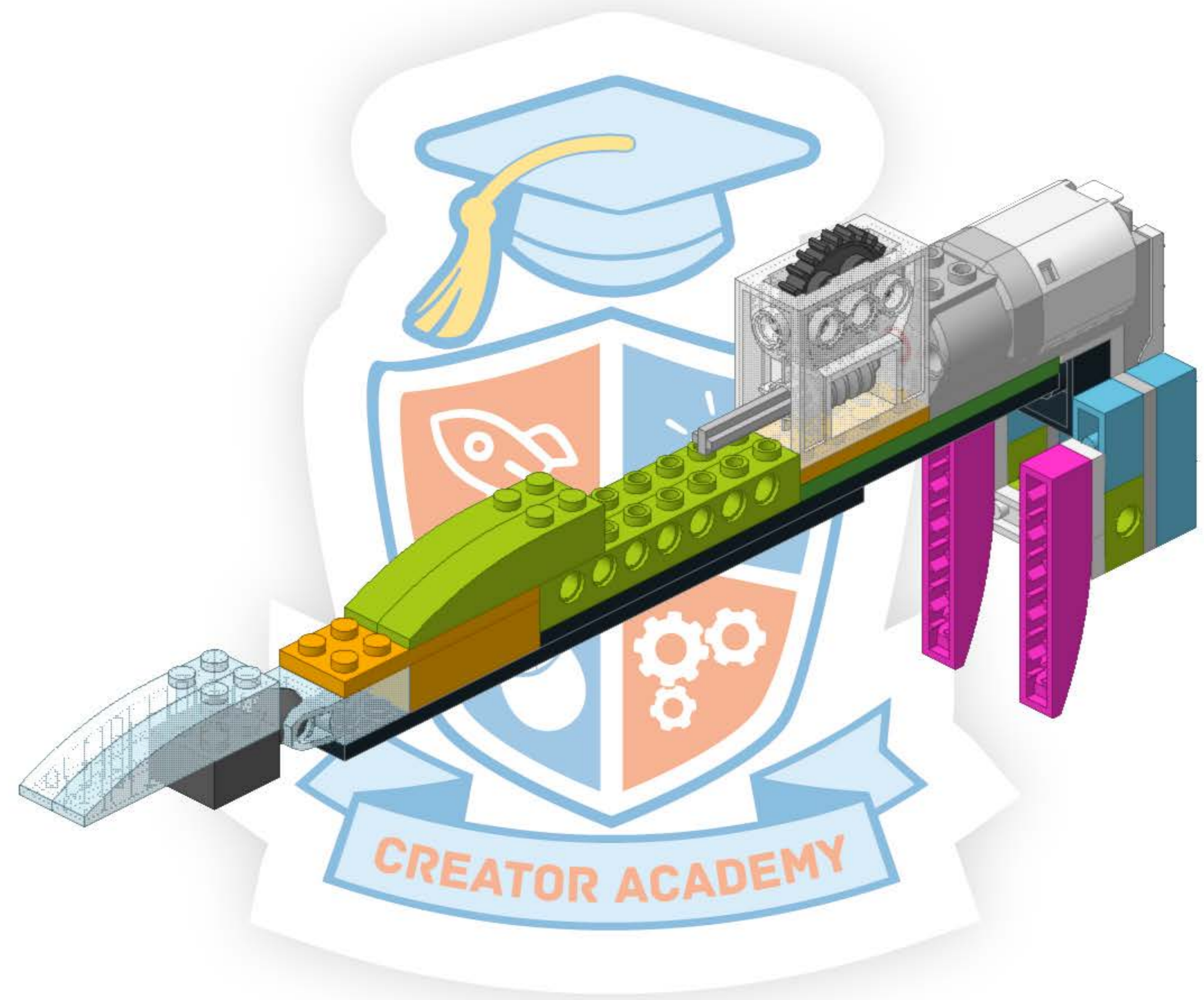
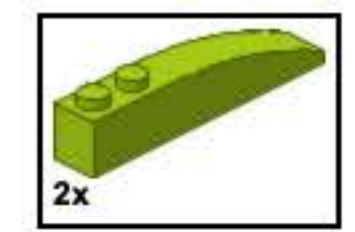

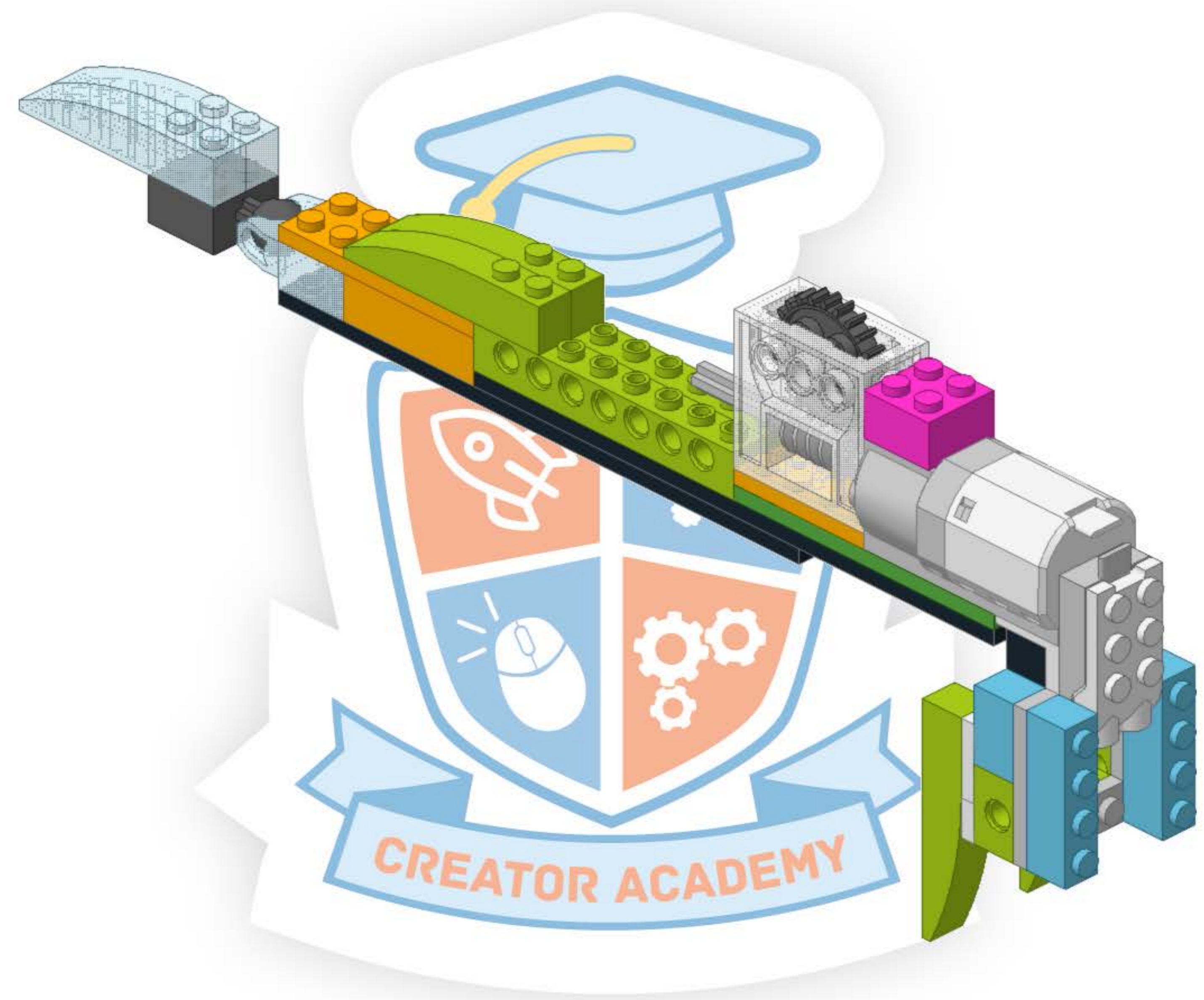
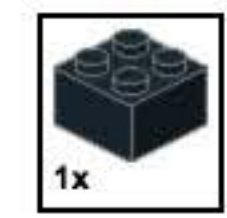



1

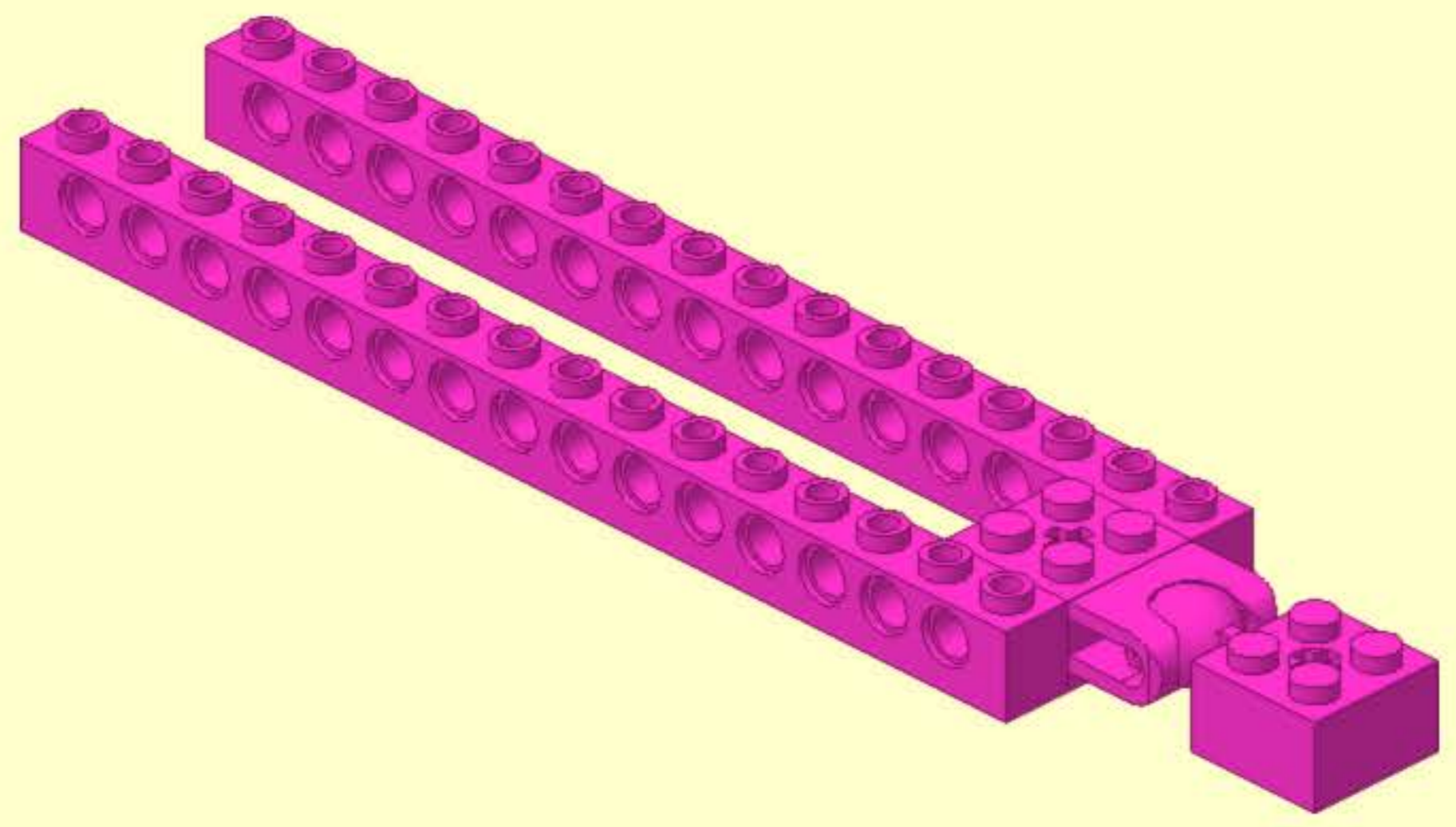
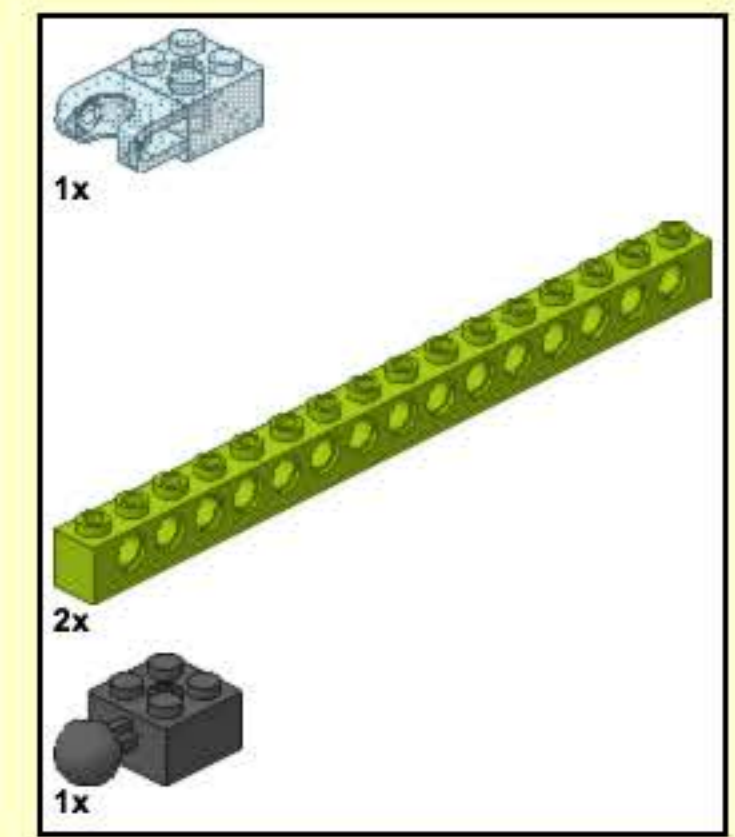

2

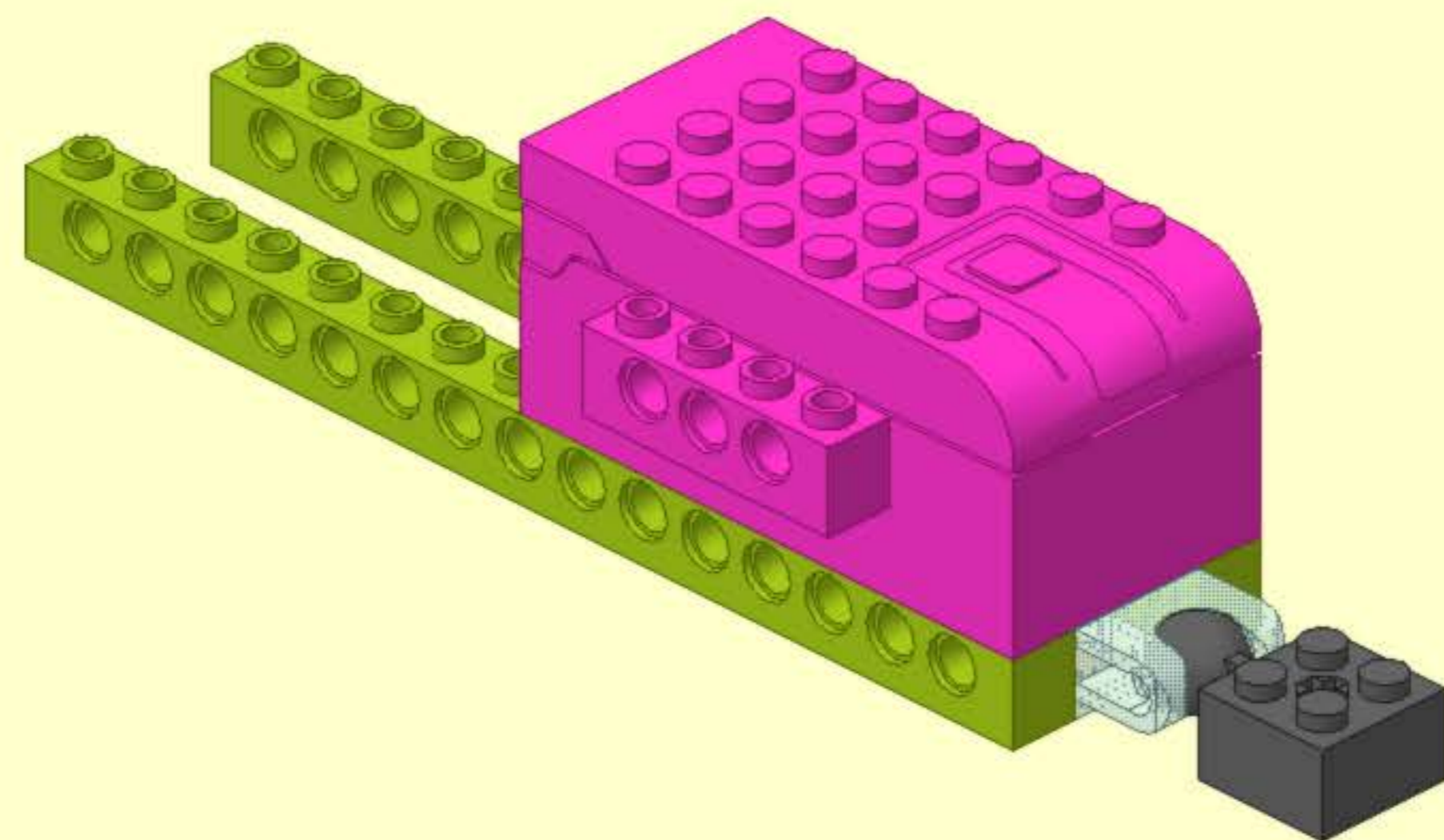
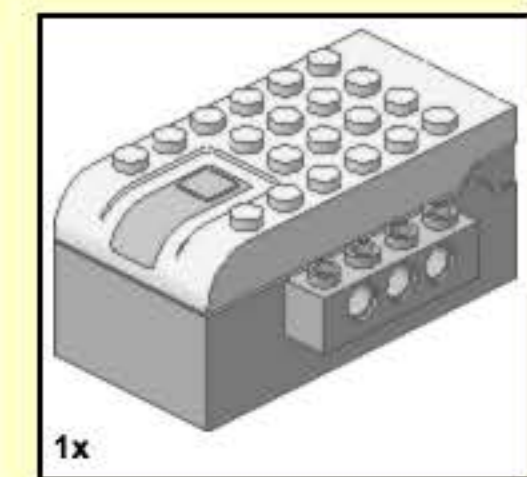

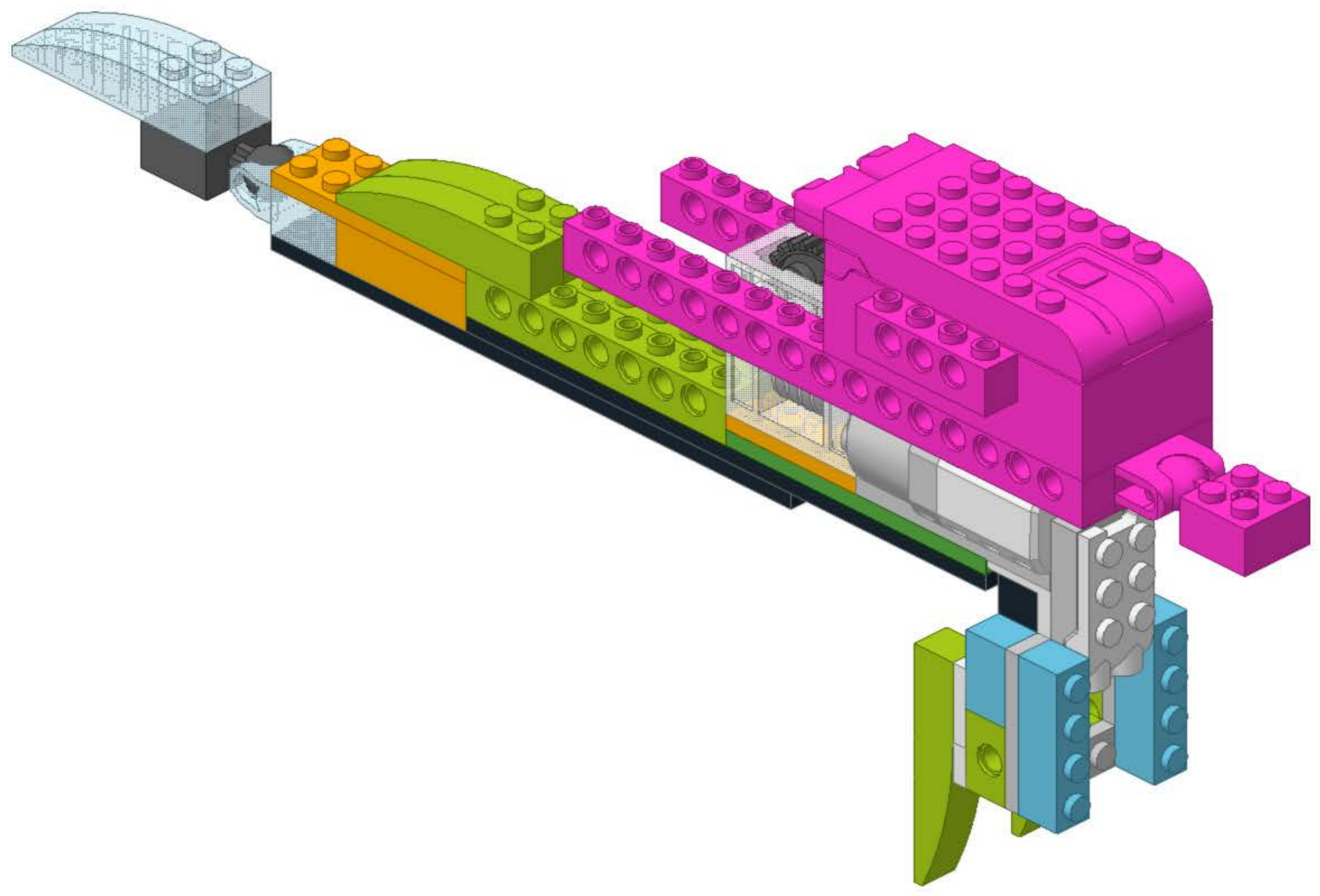
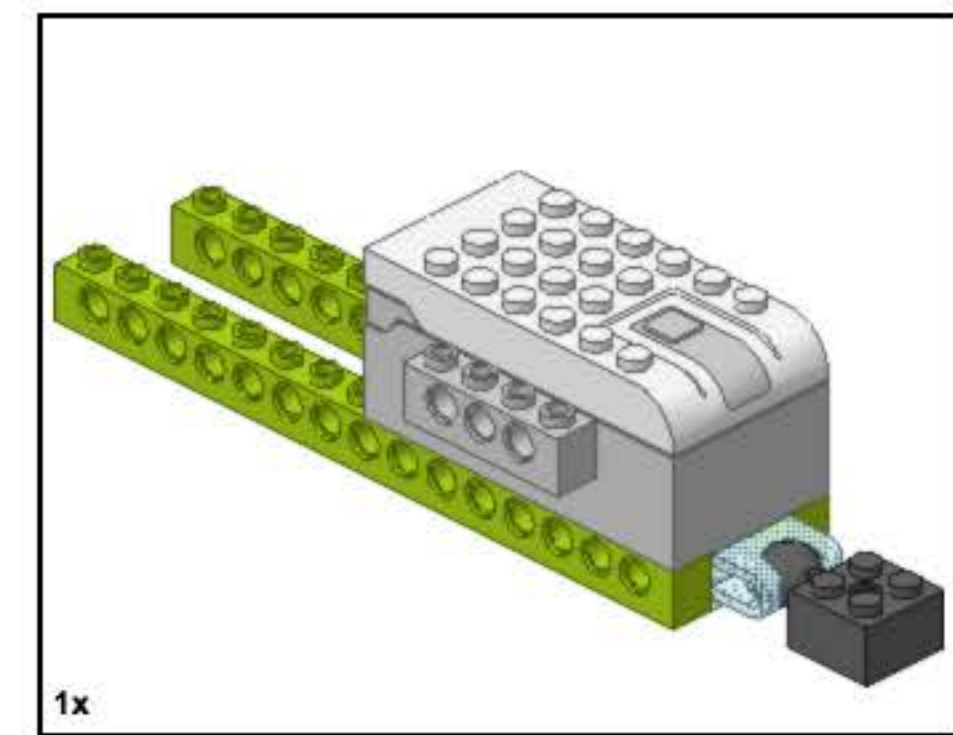

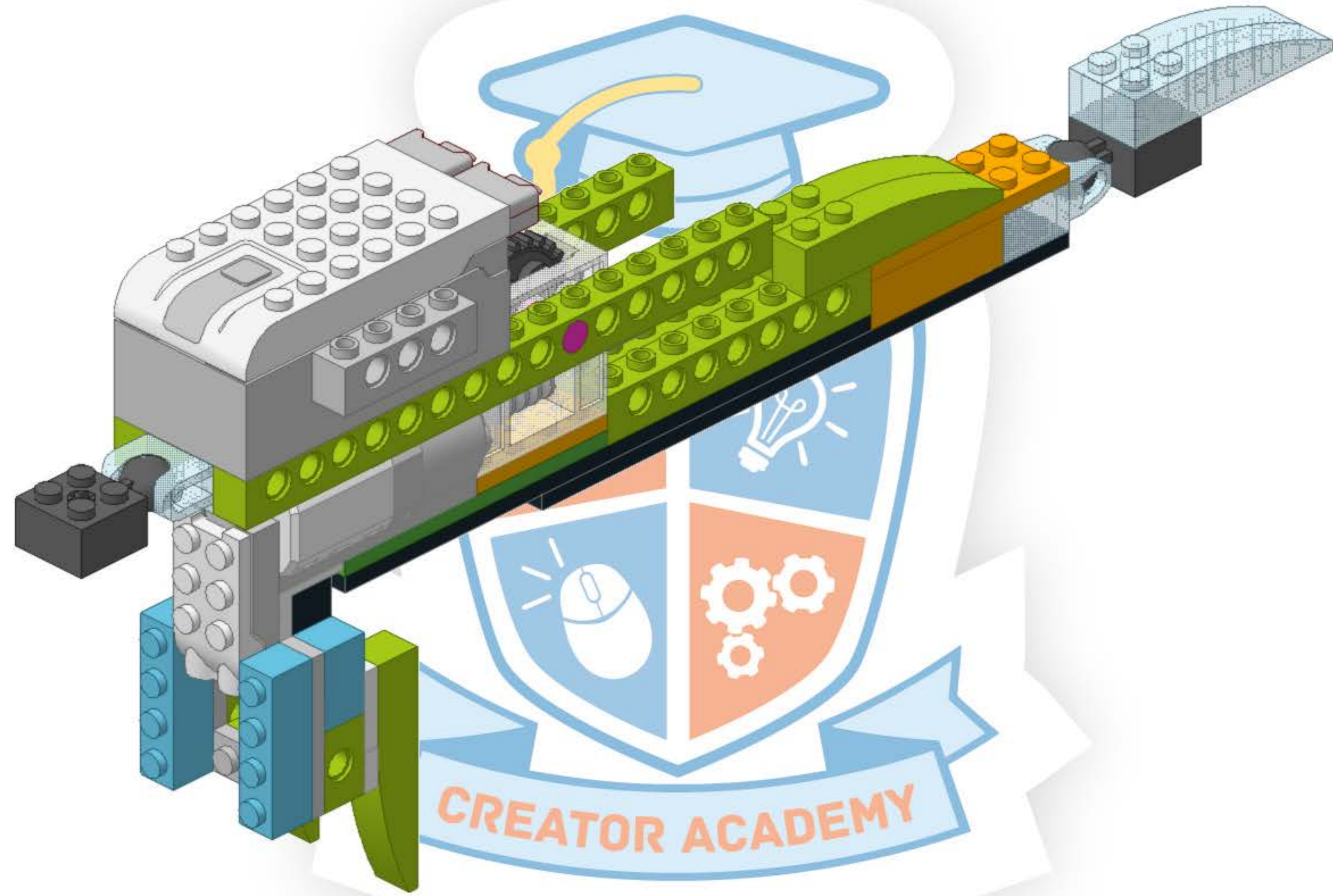
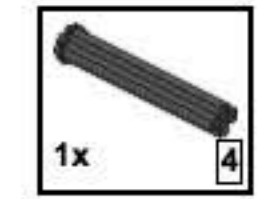

1

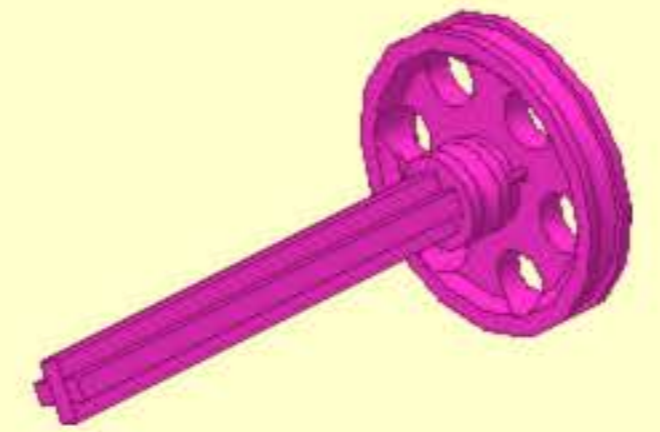
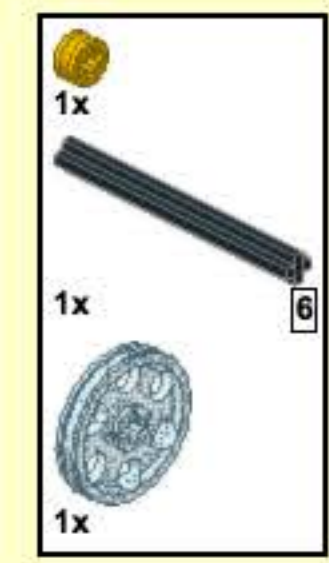

2

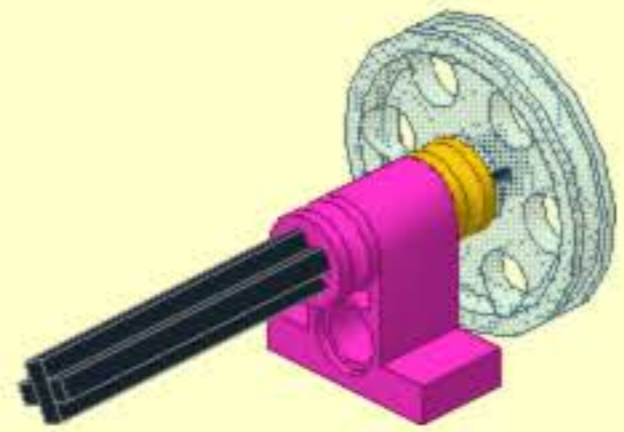

3

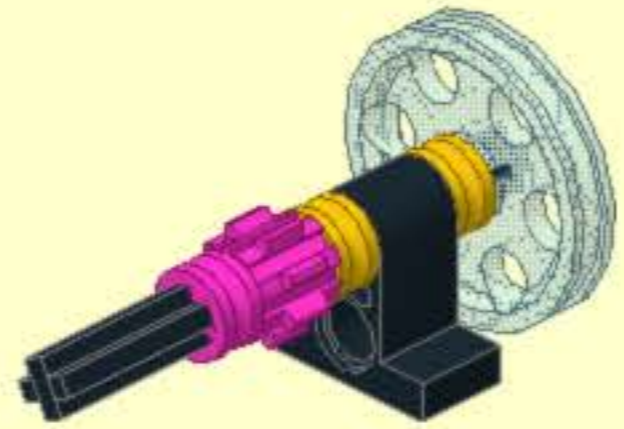

4

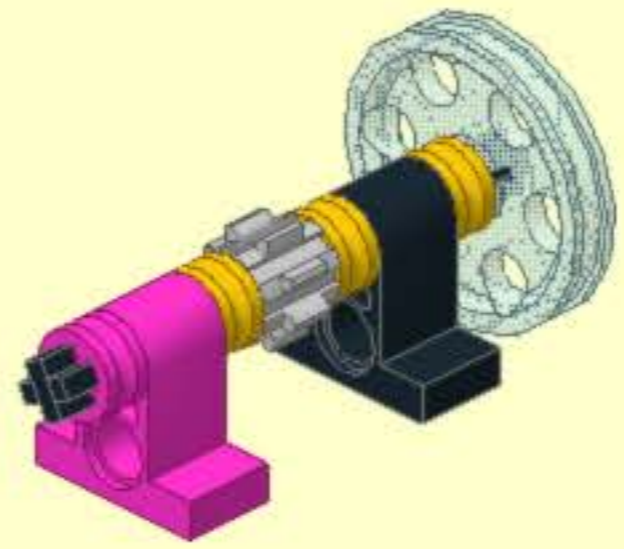



5

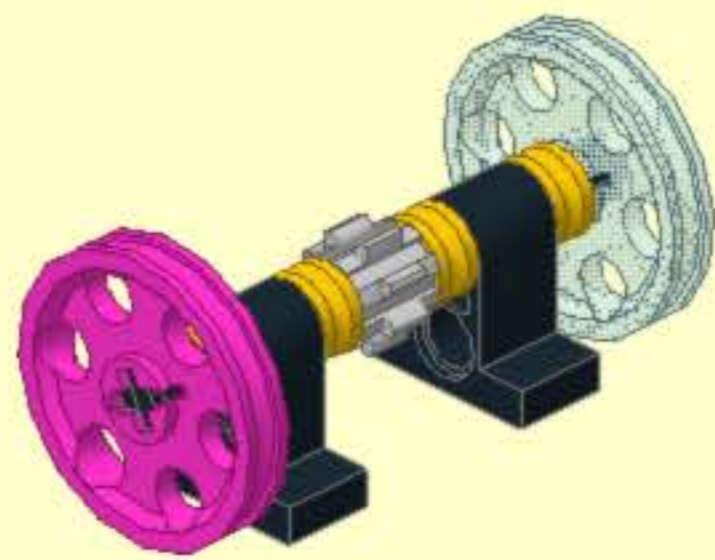
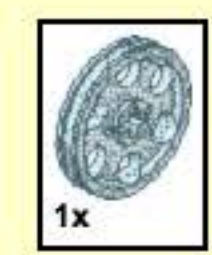

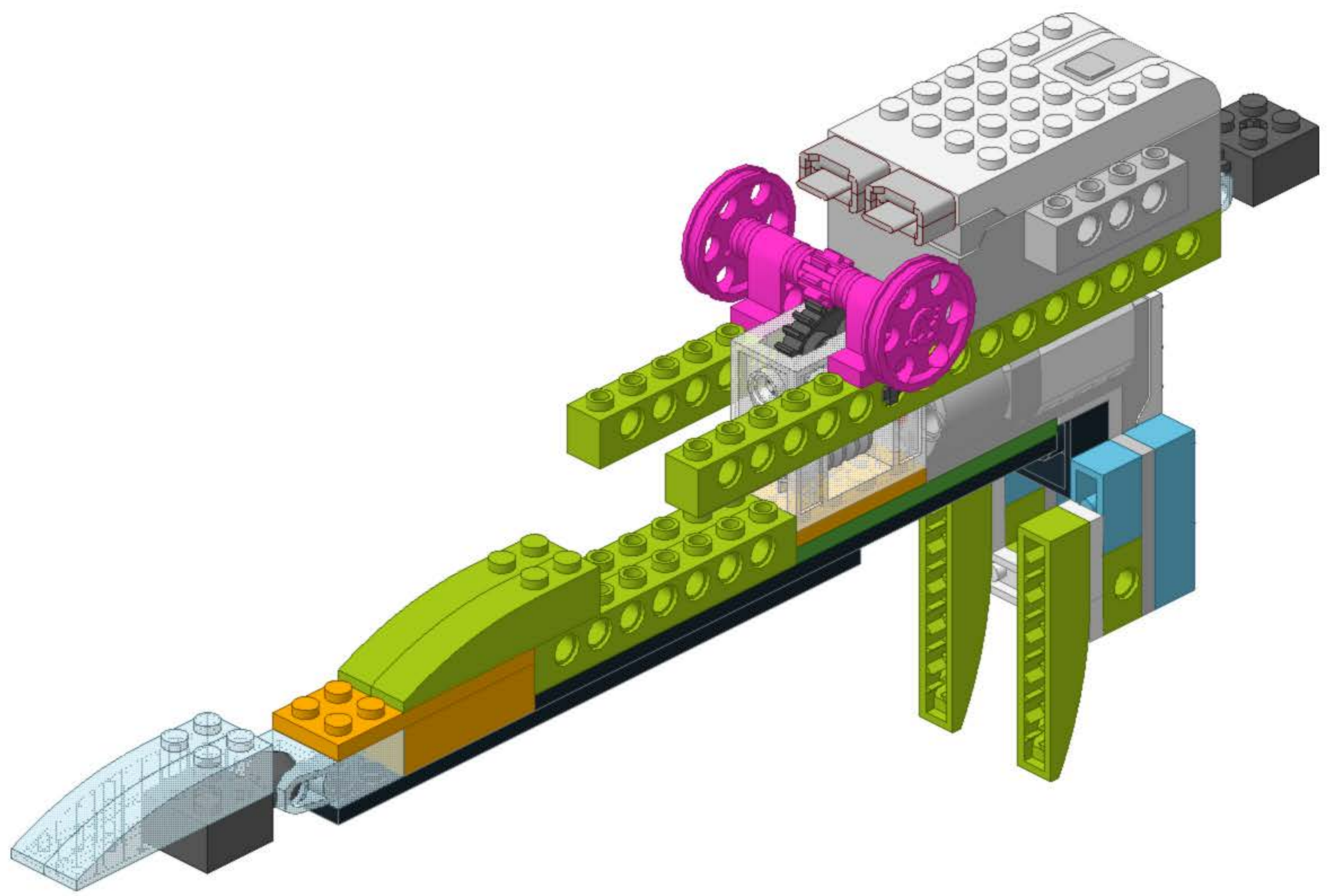
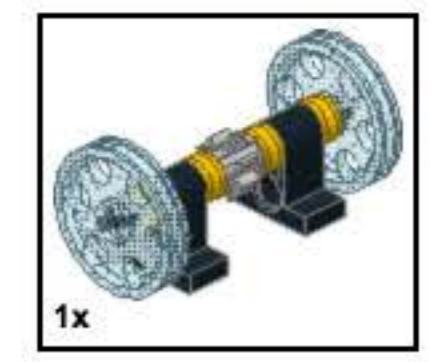

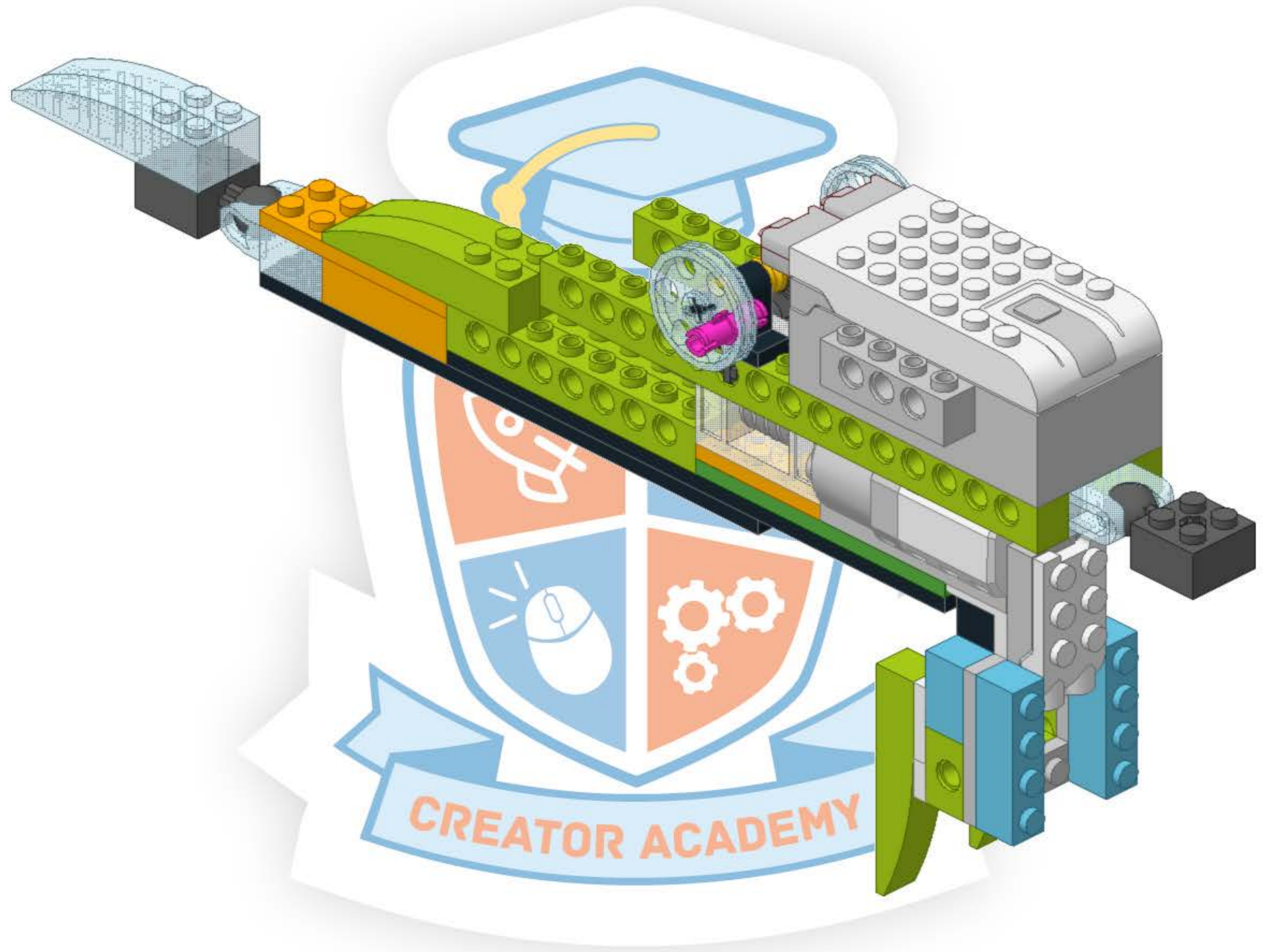

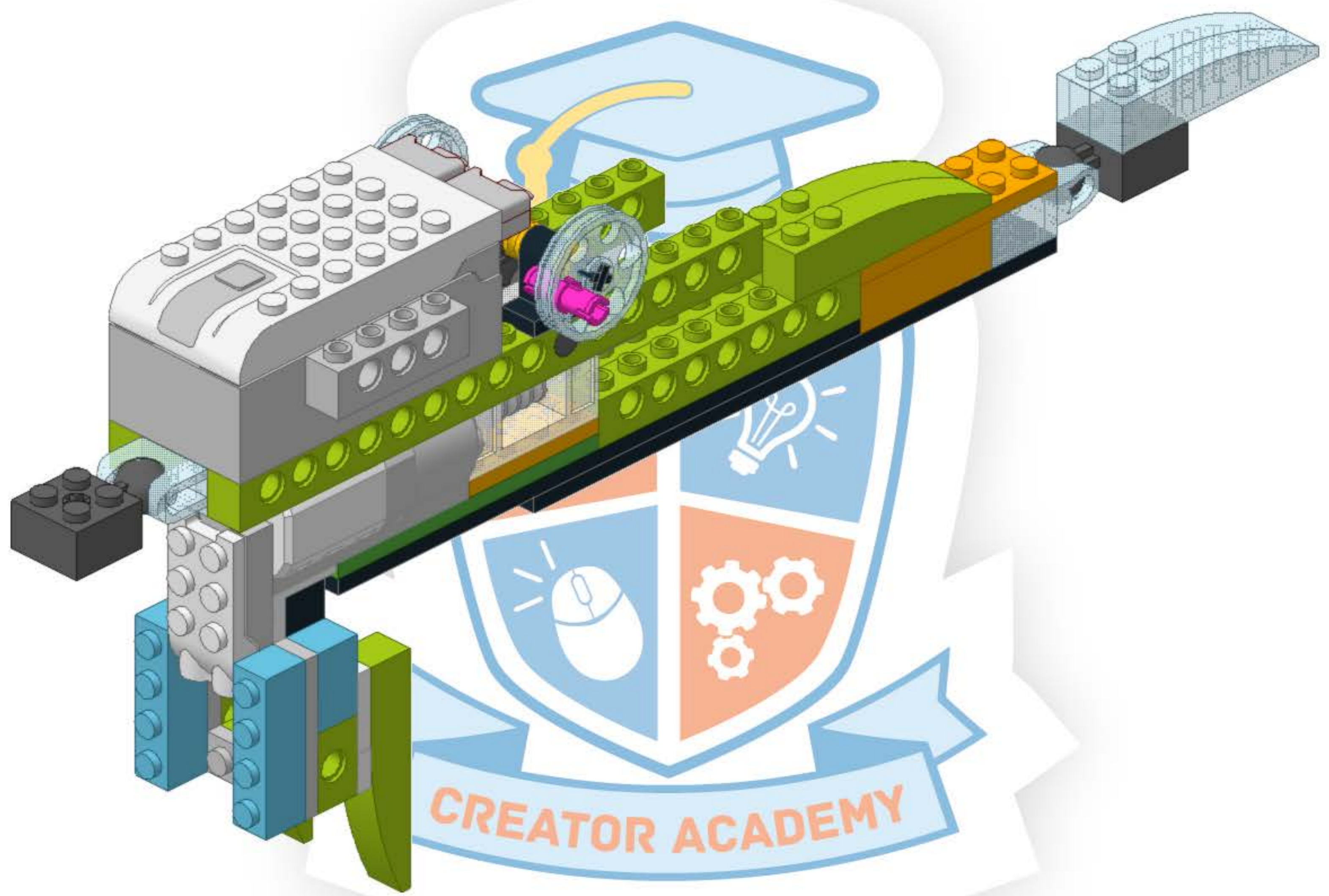

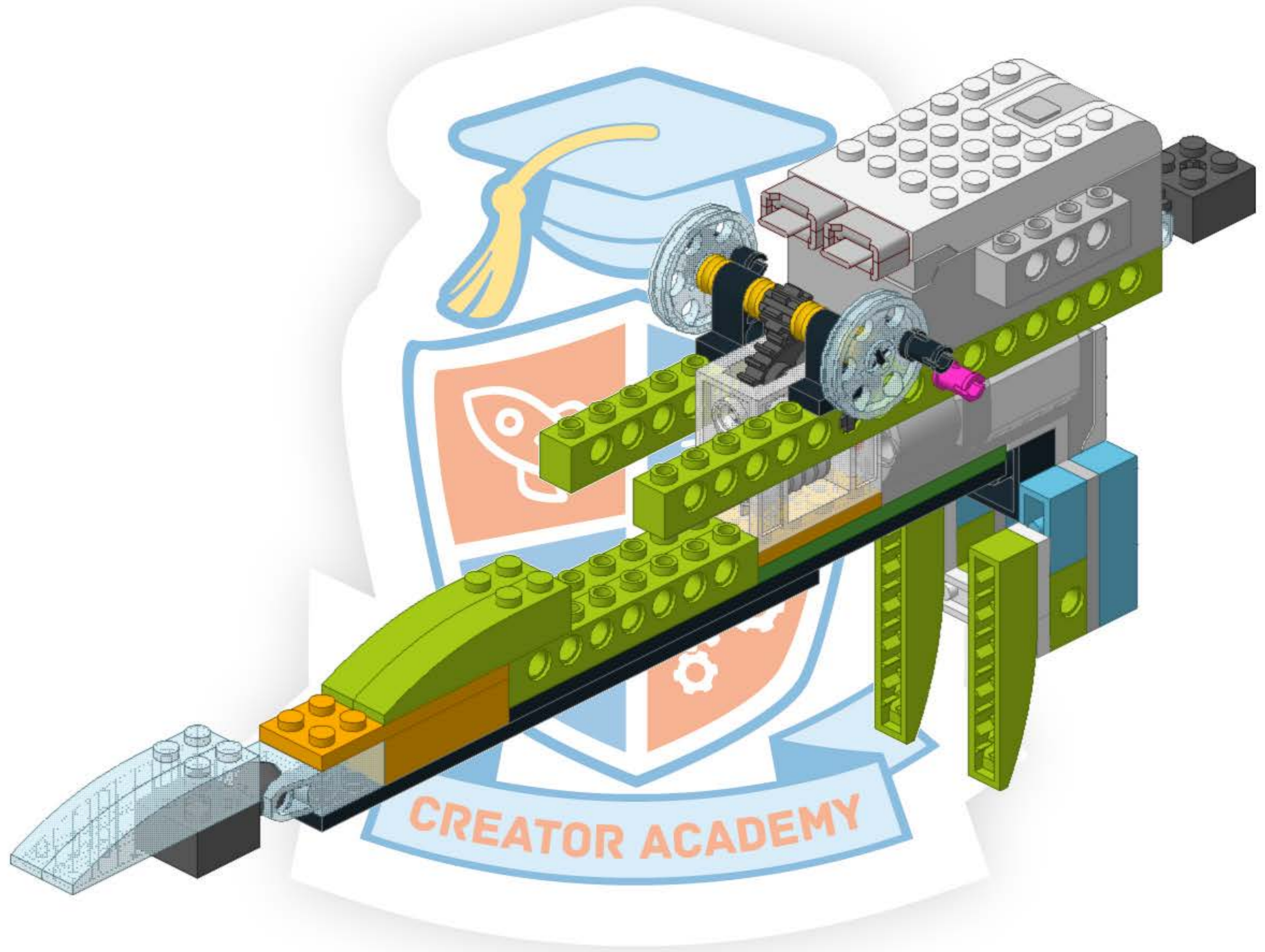



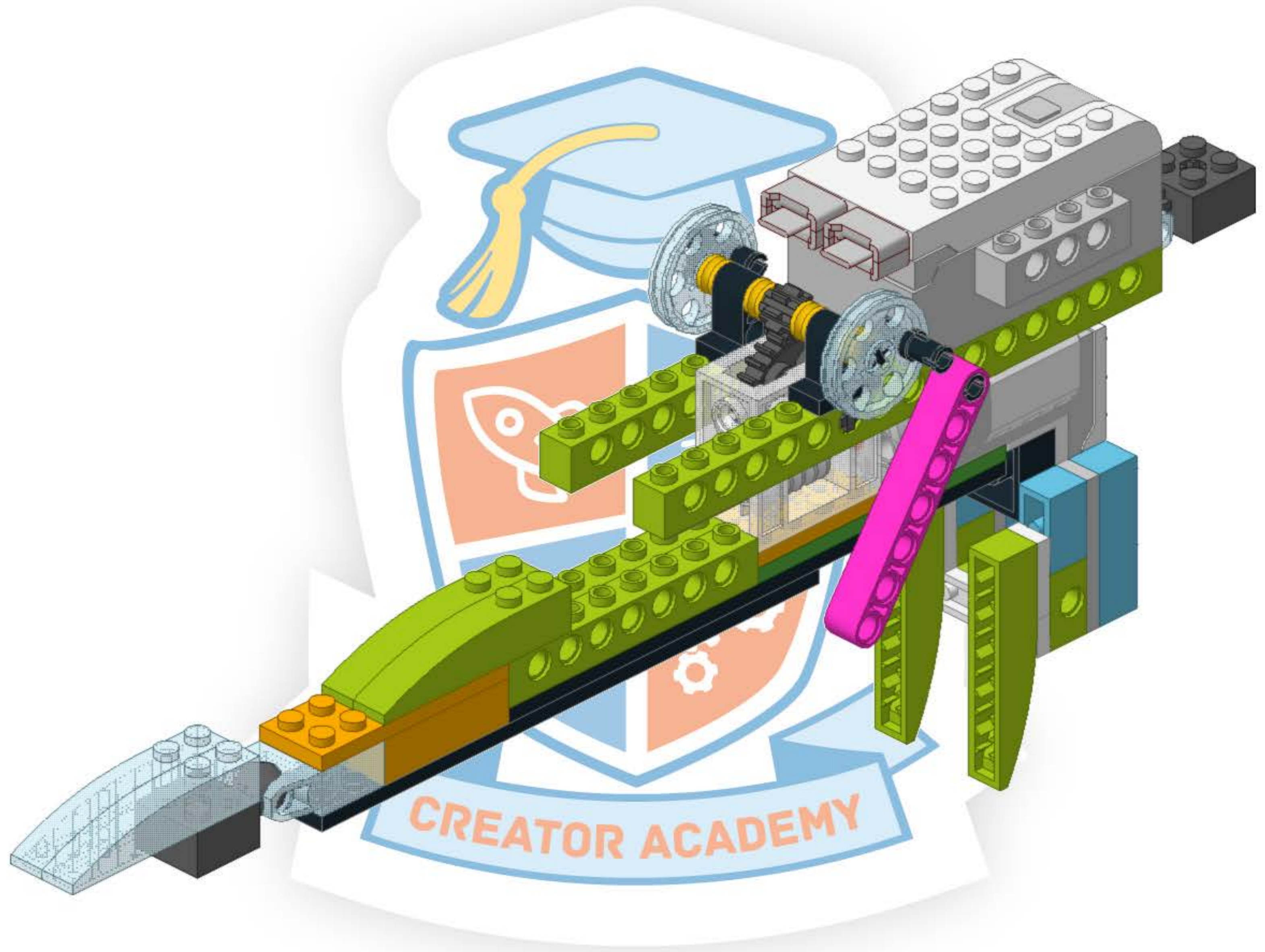
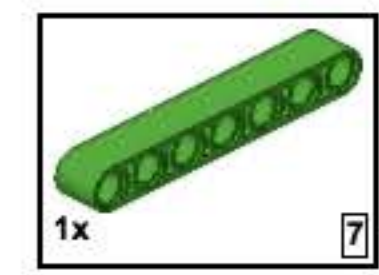

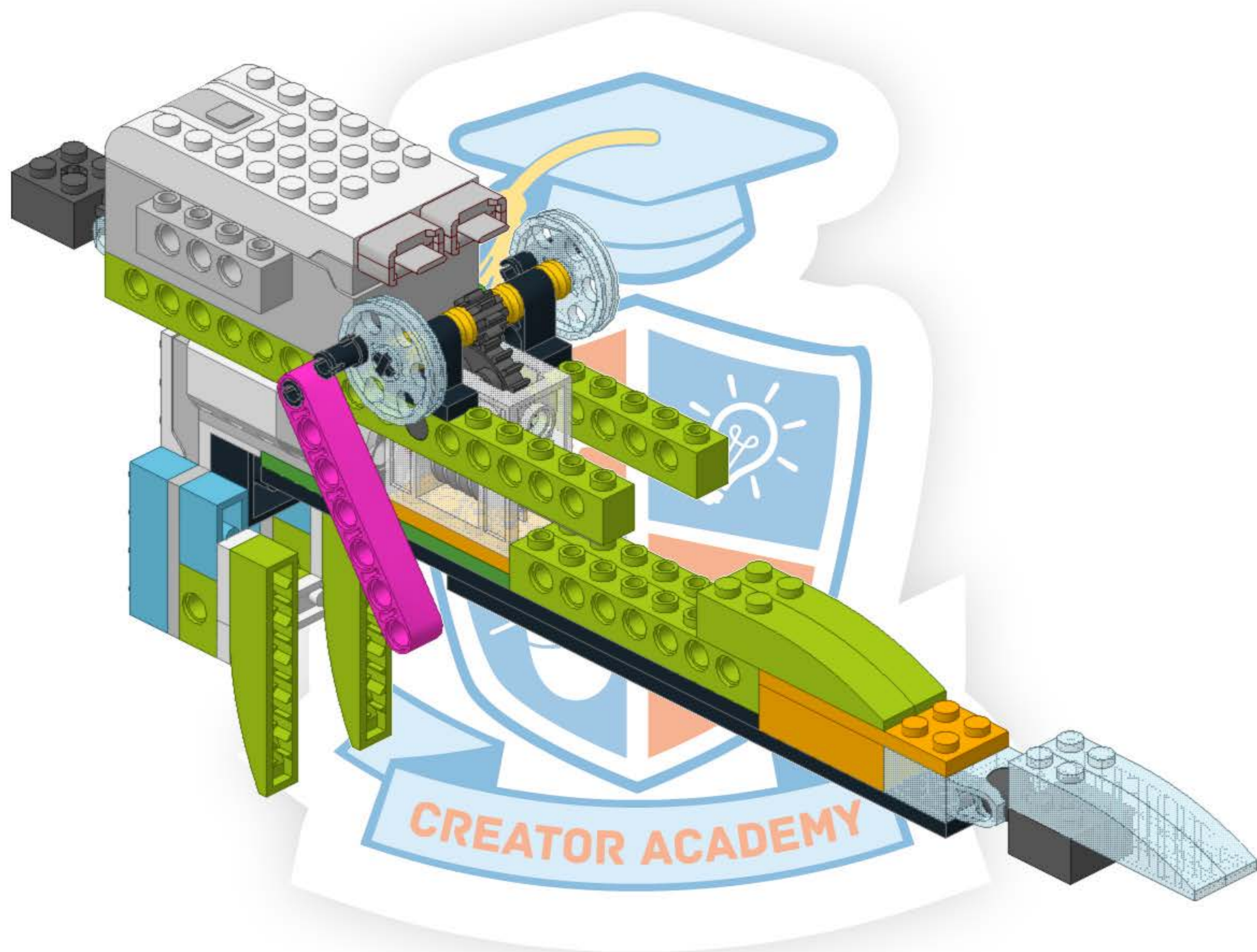
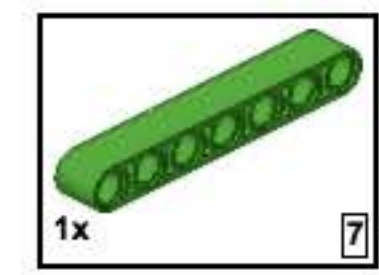



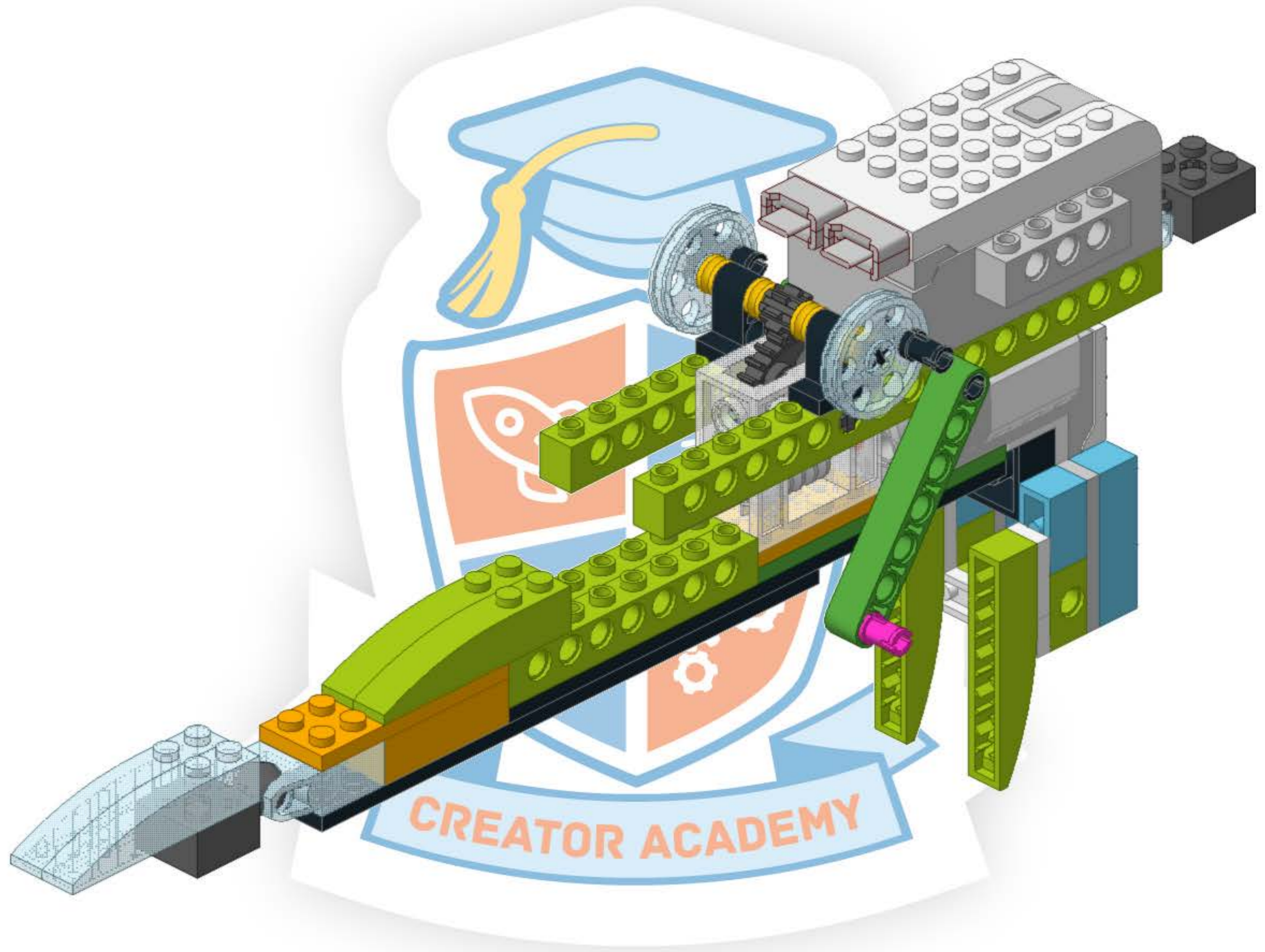

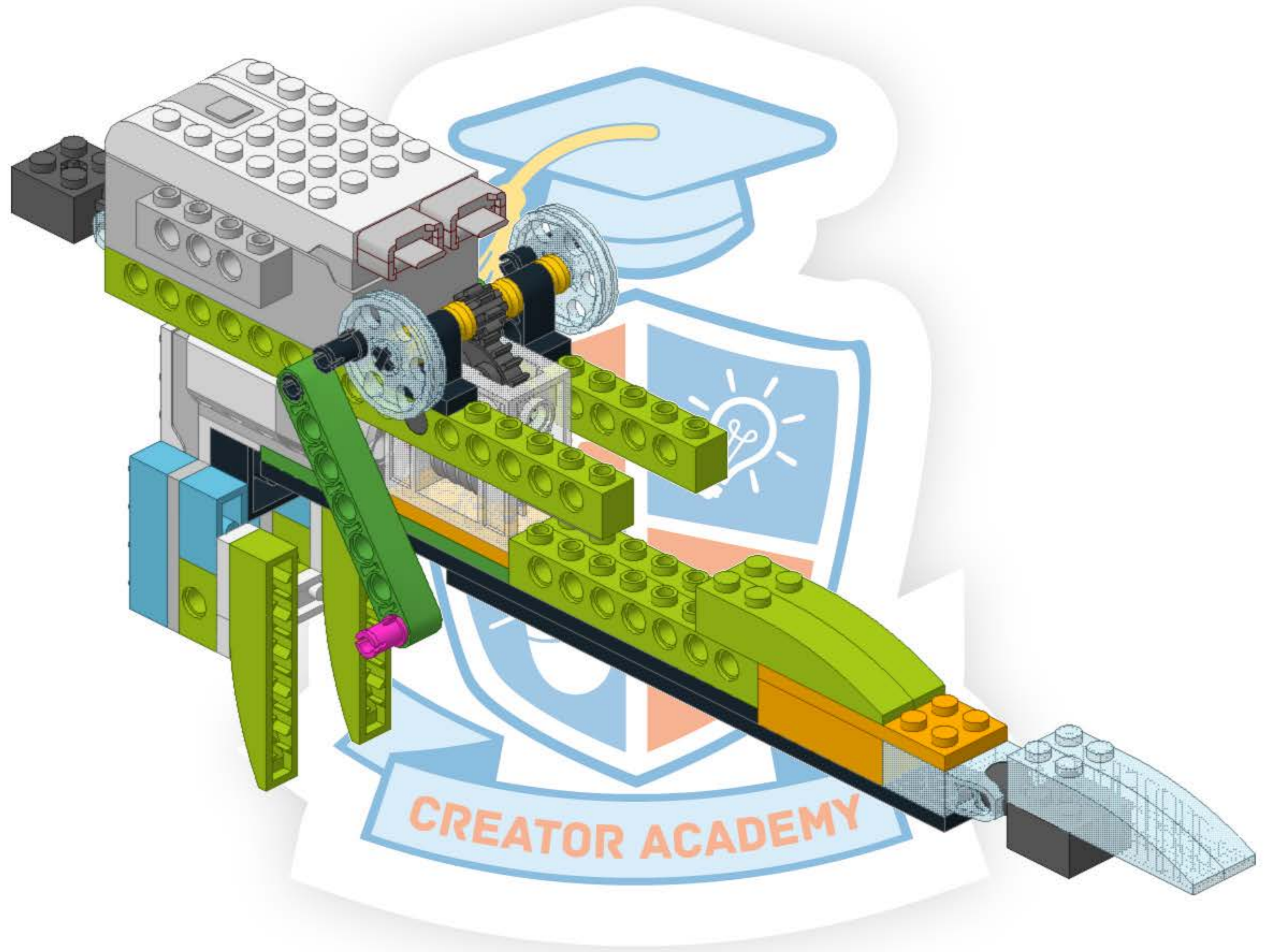

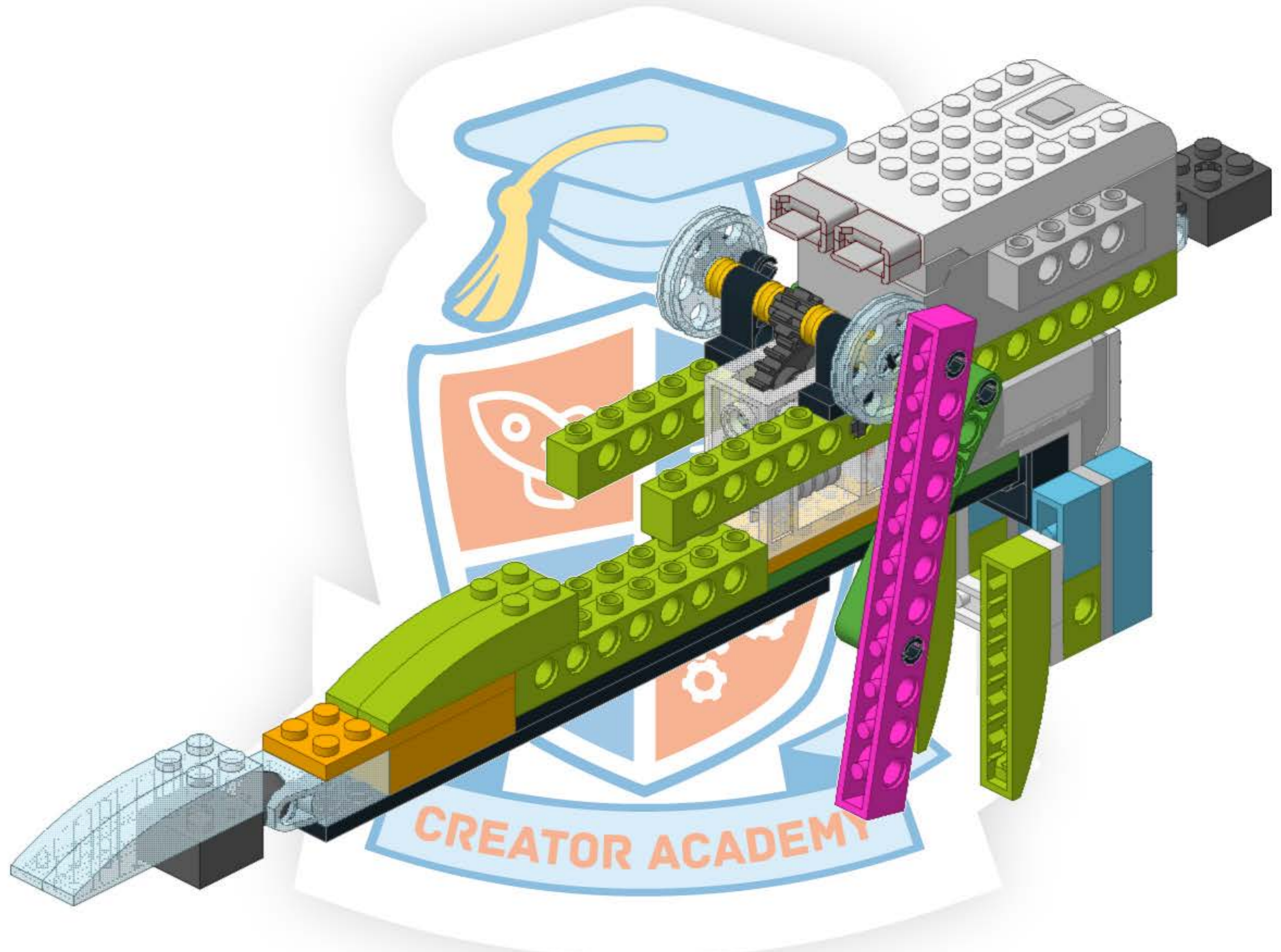
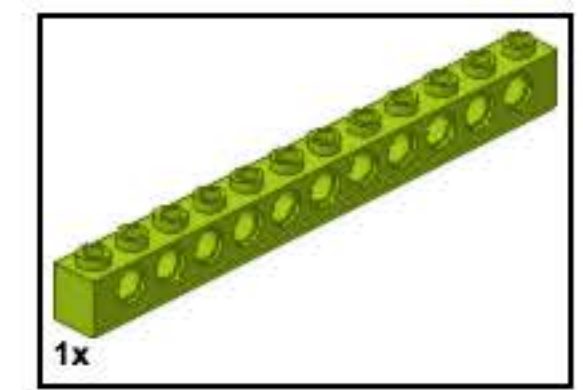

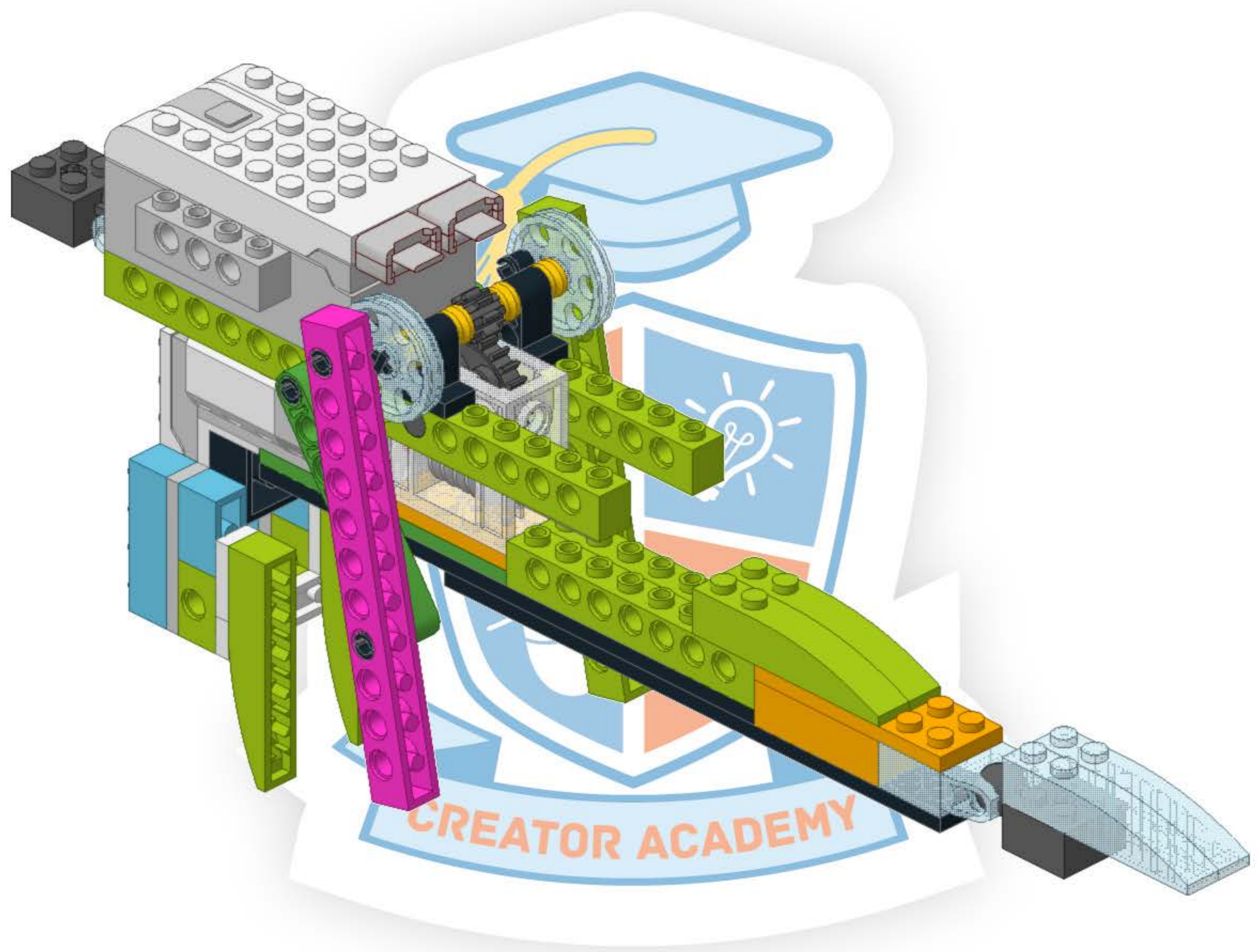
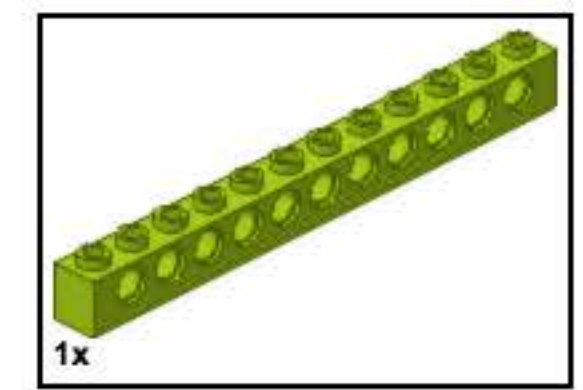

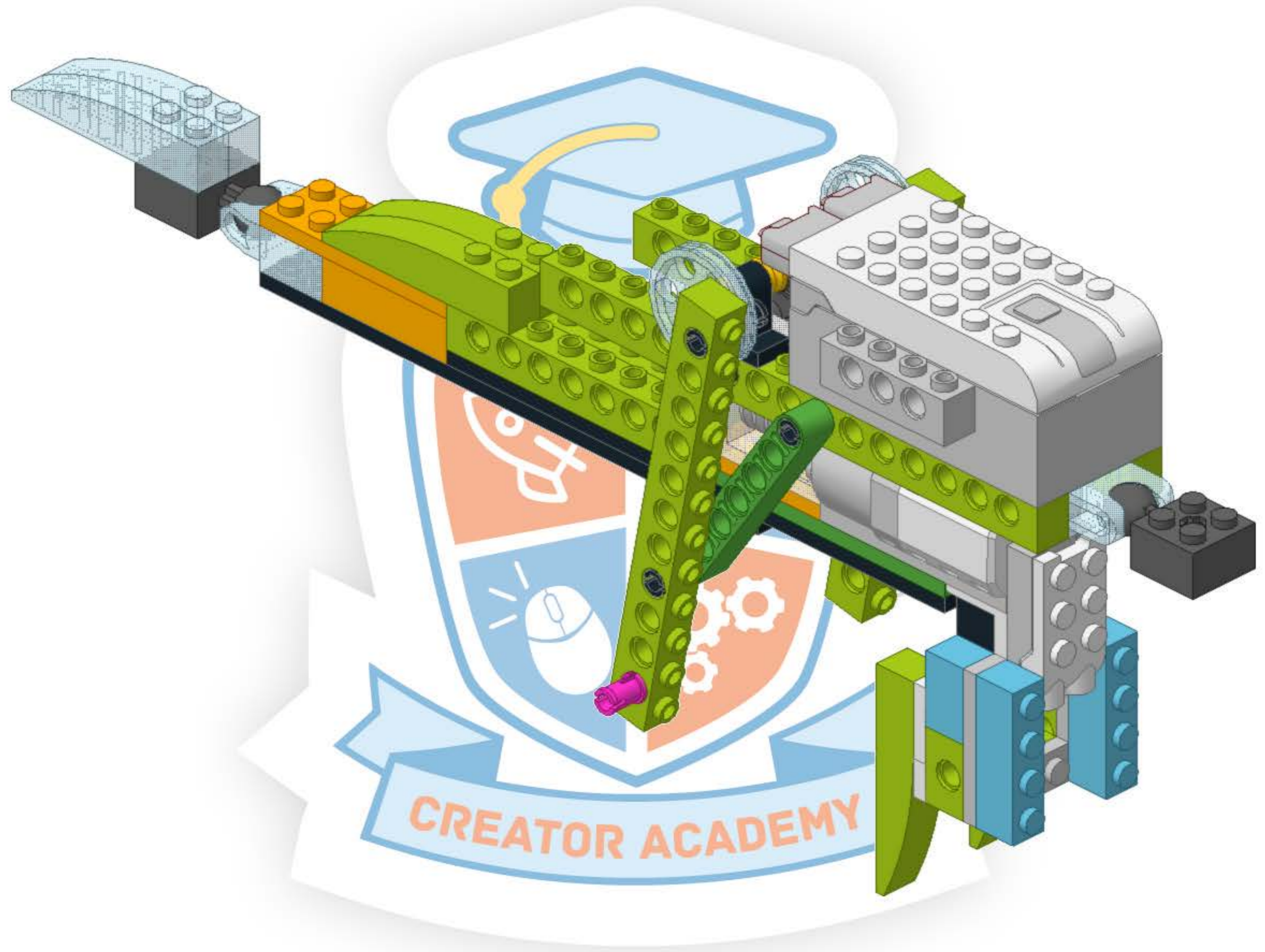

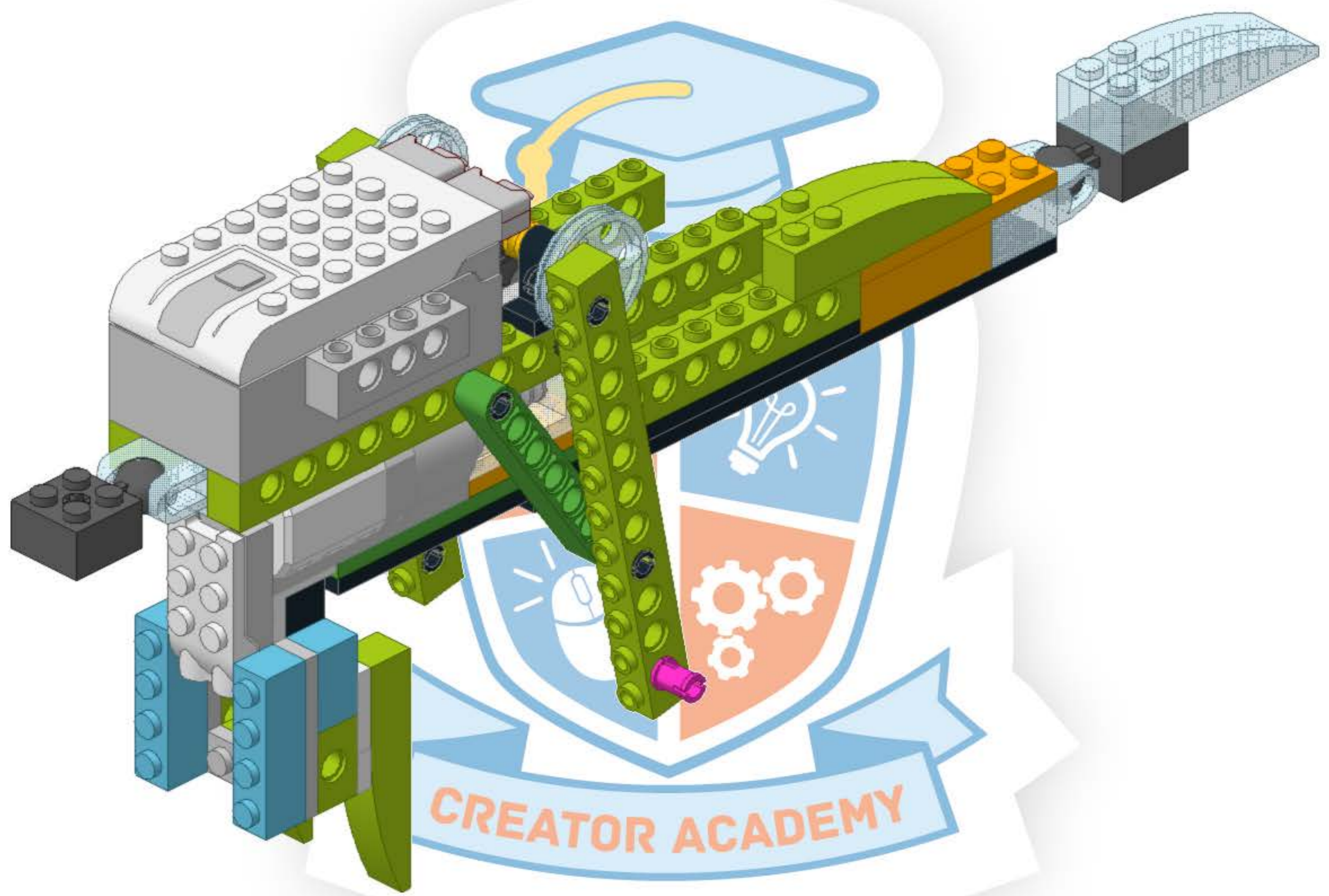

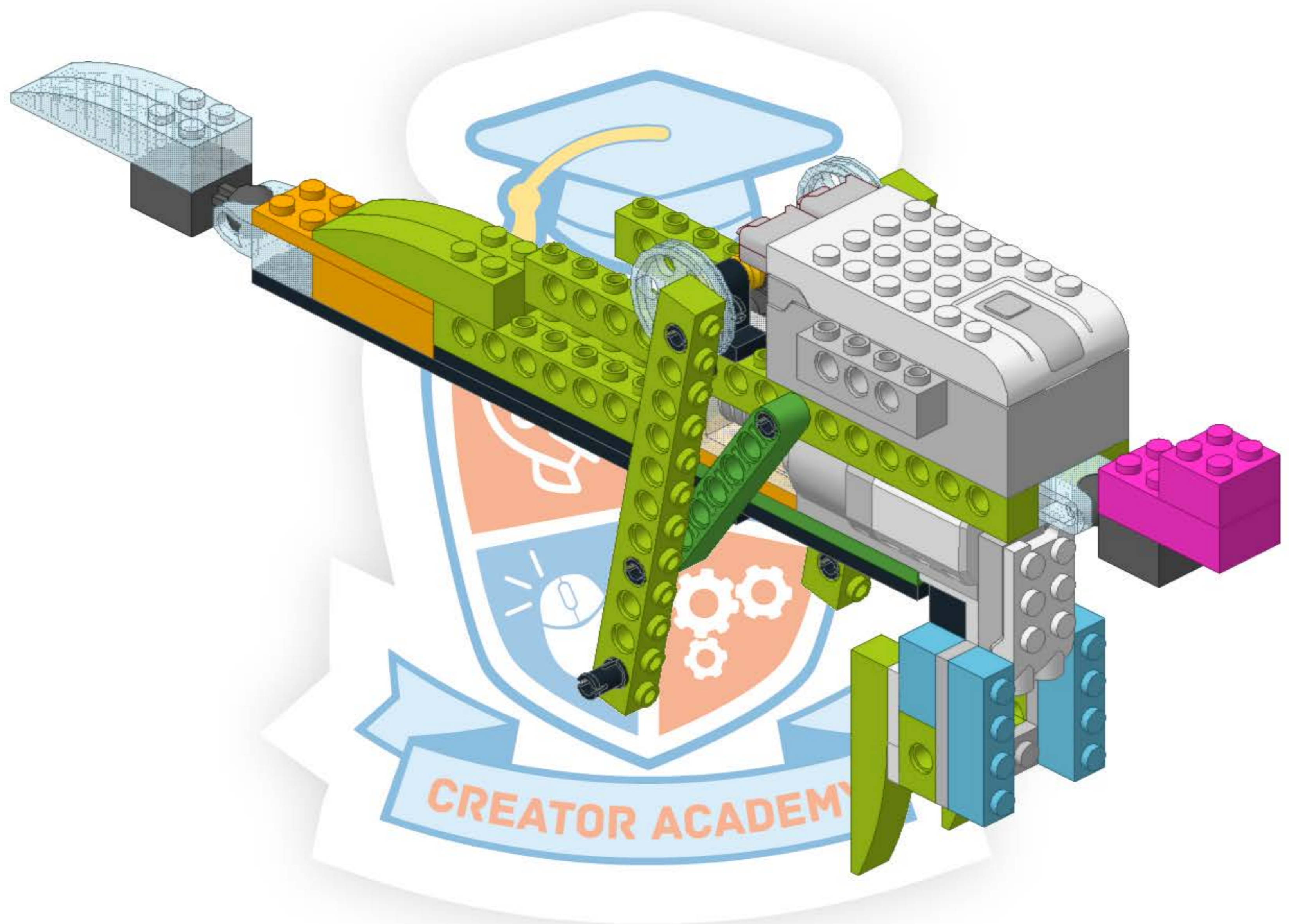
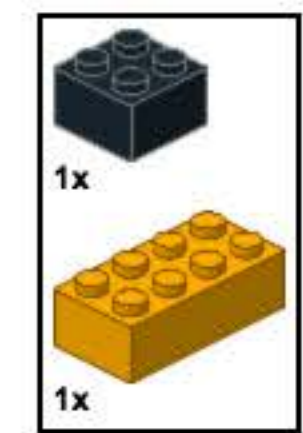





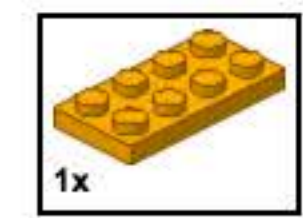

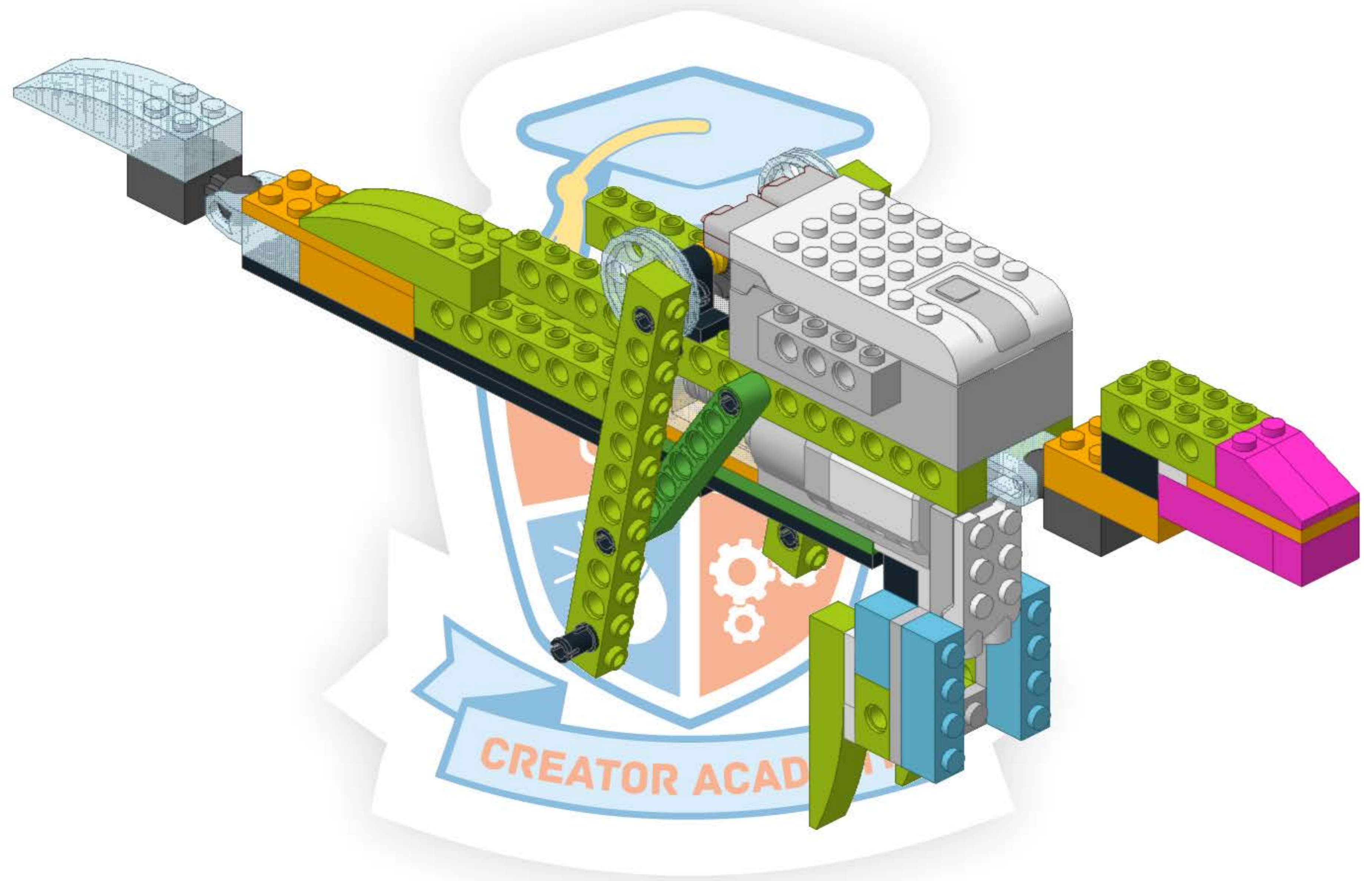
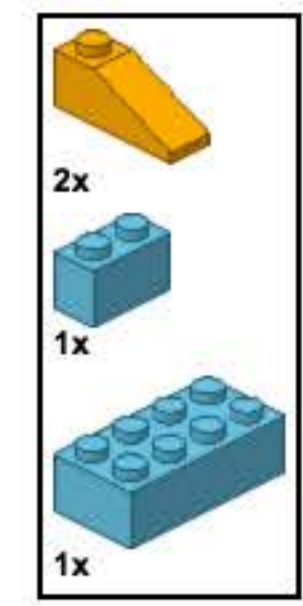

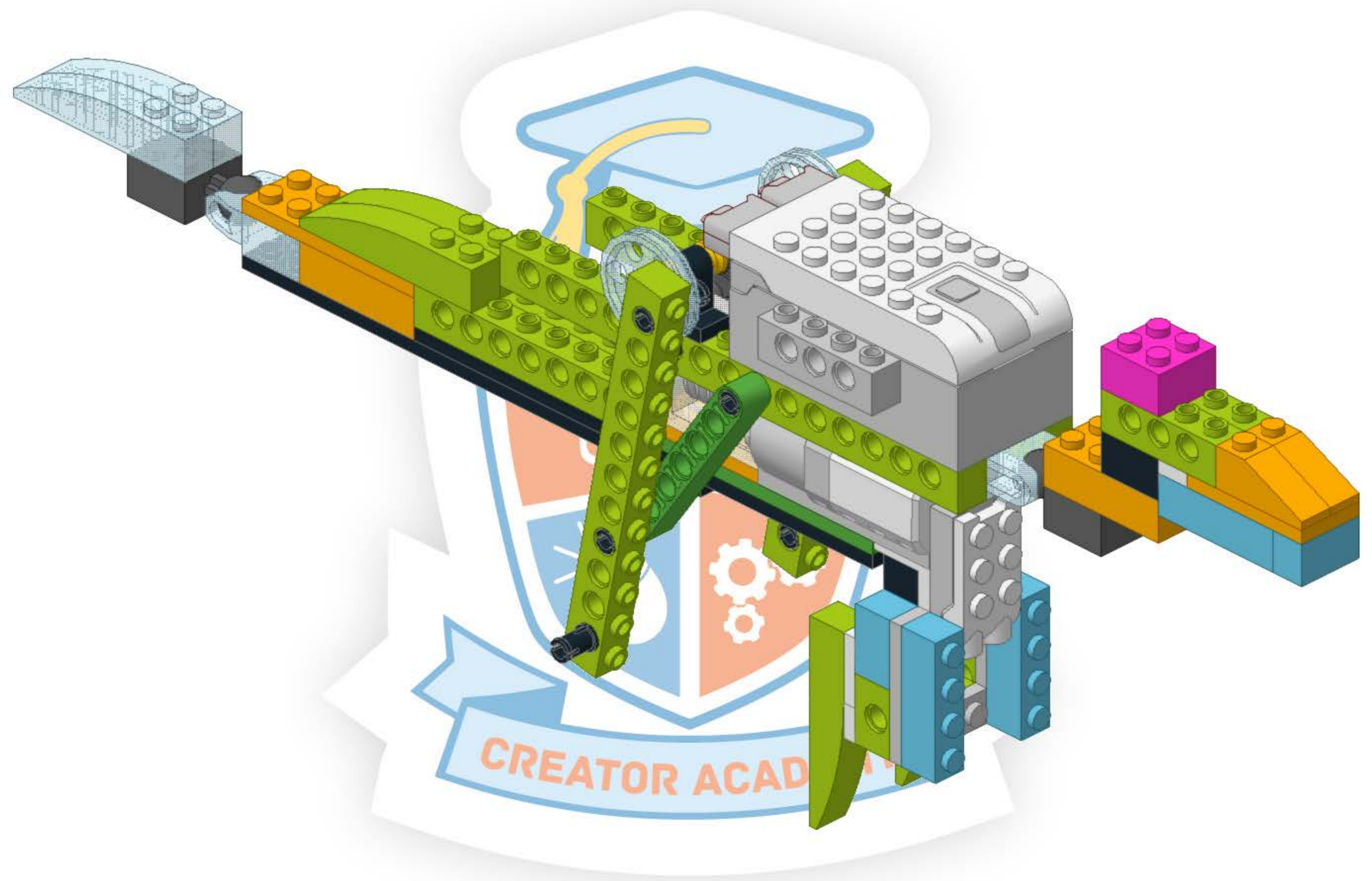
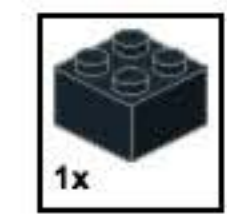

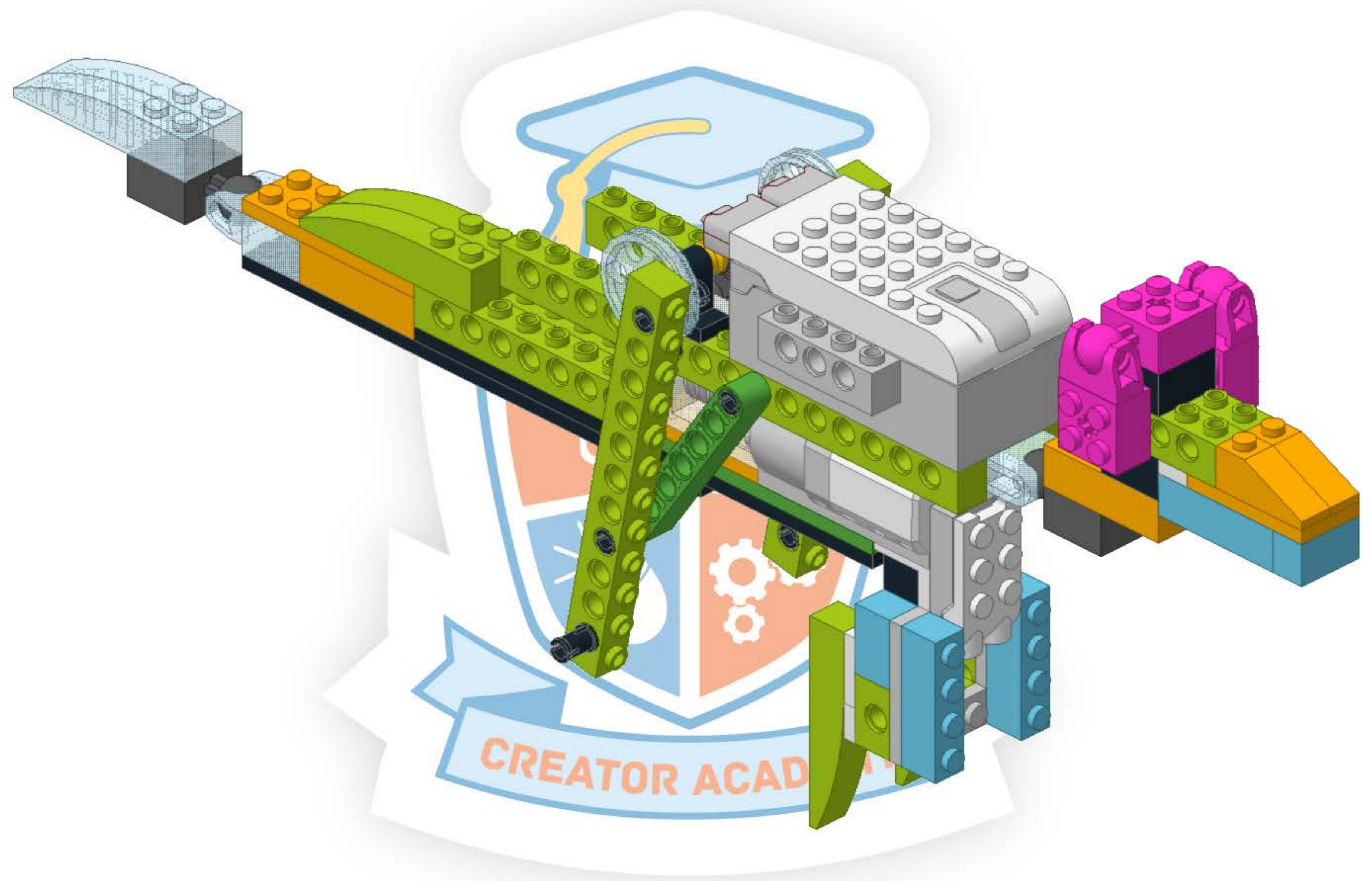
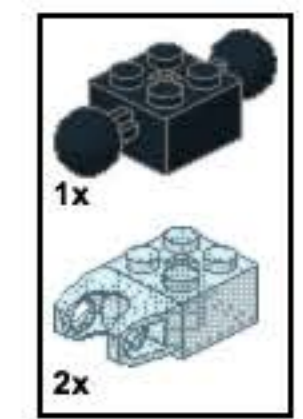

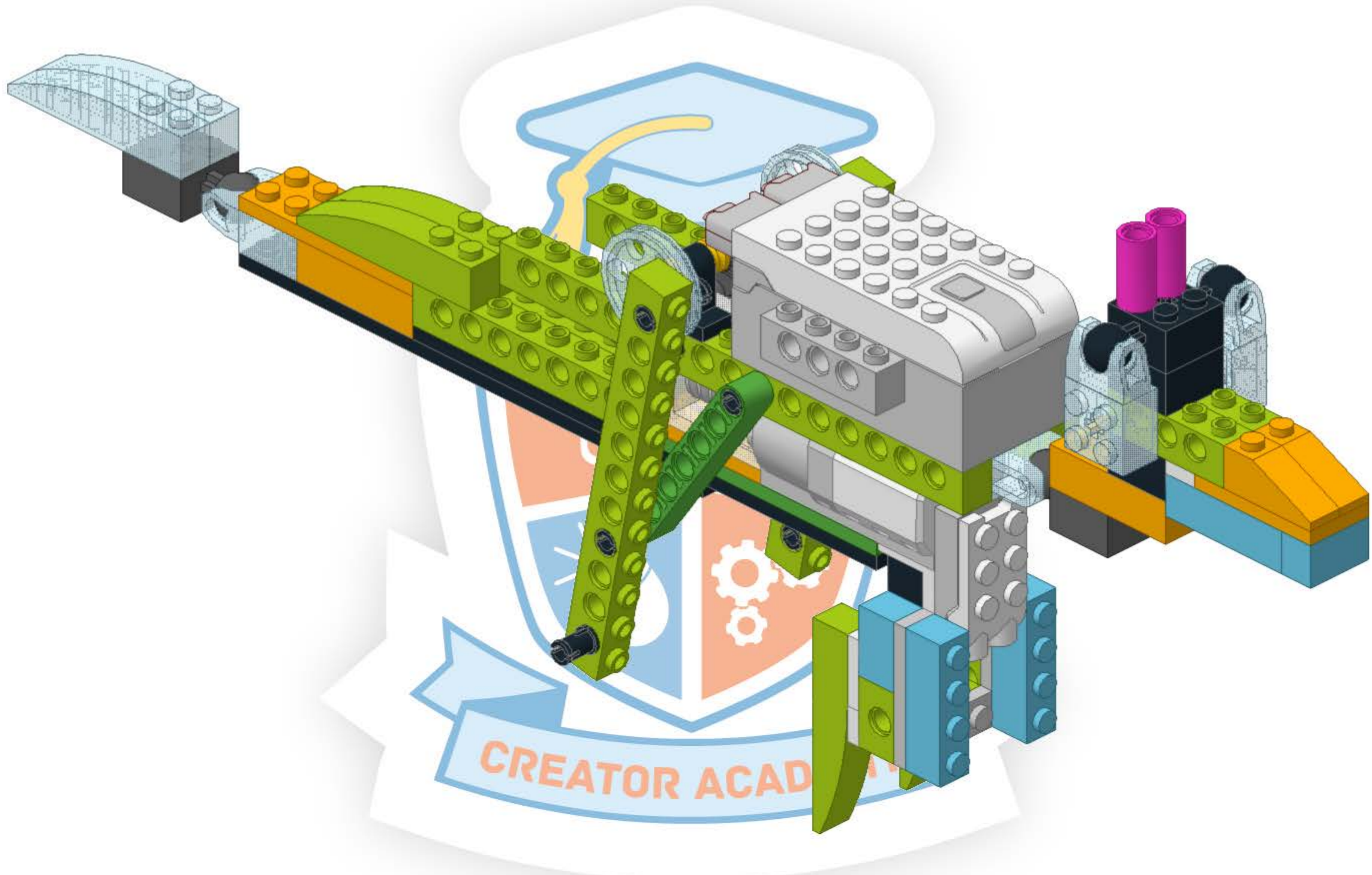
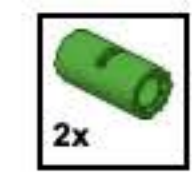

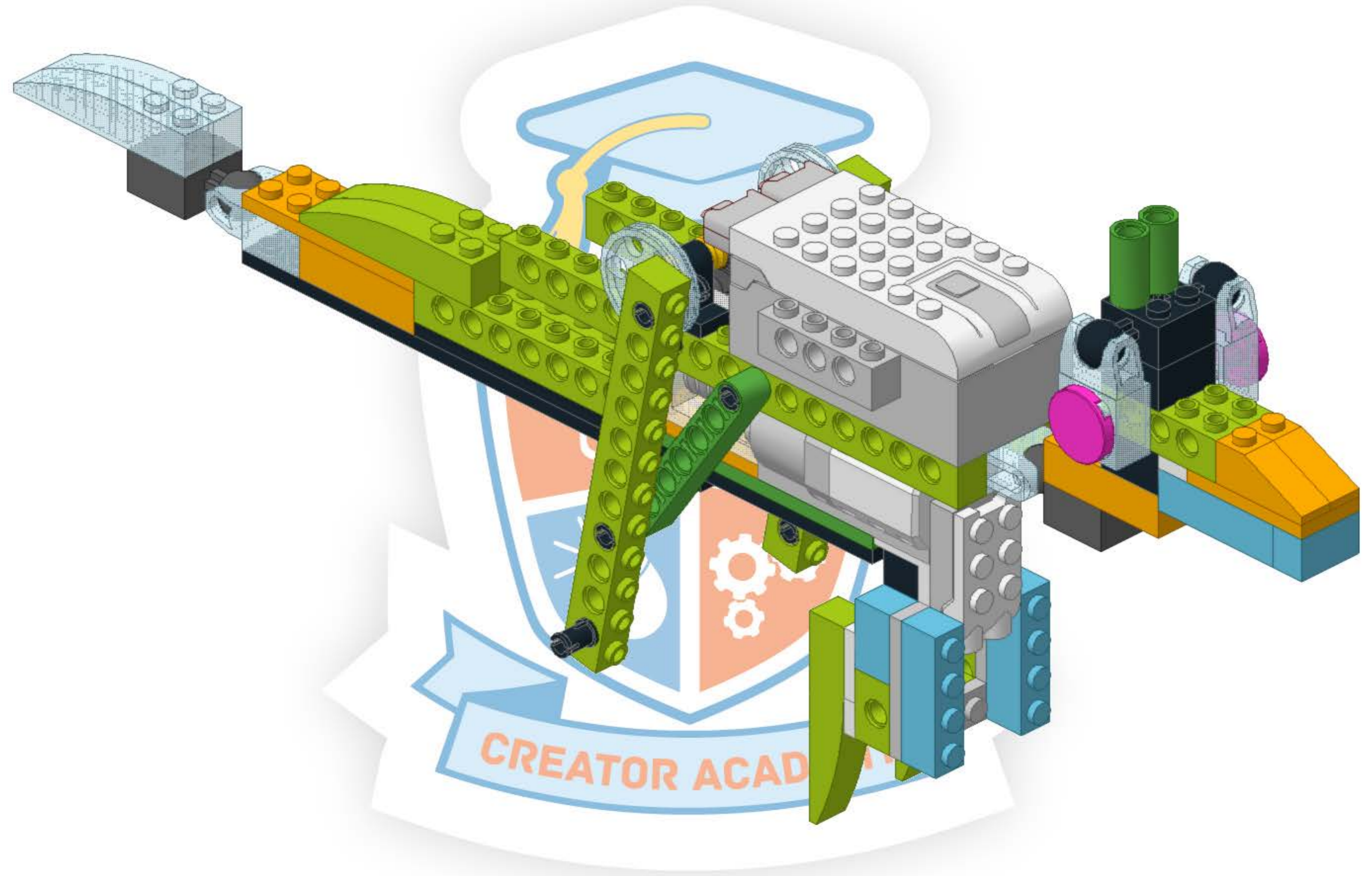
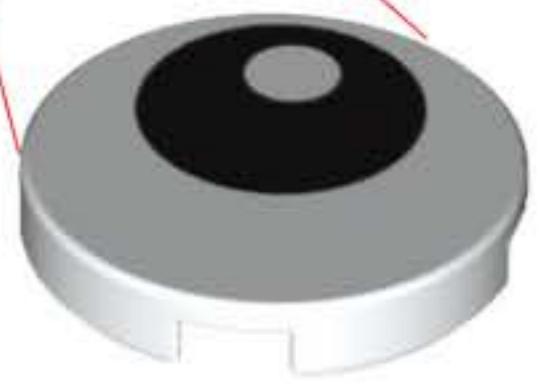



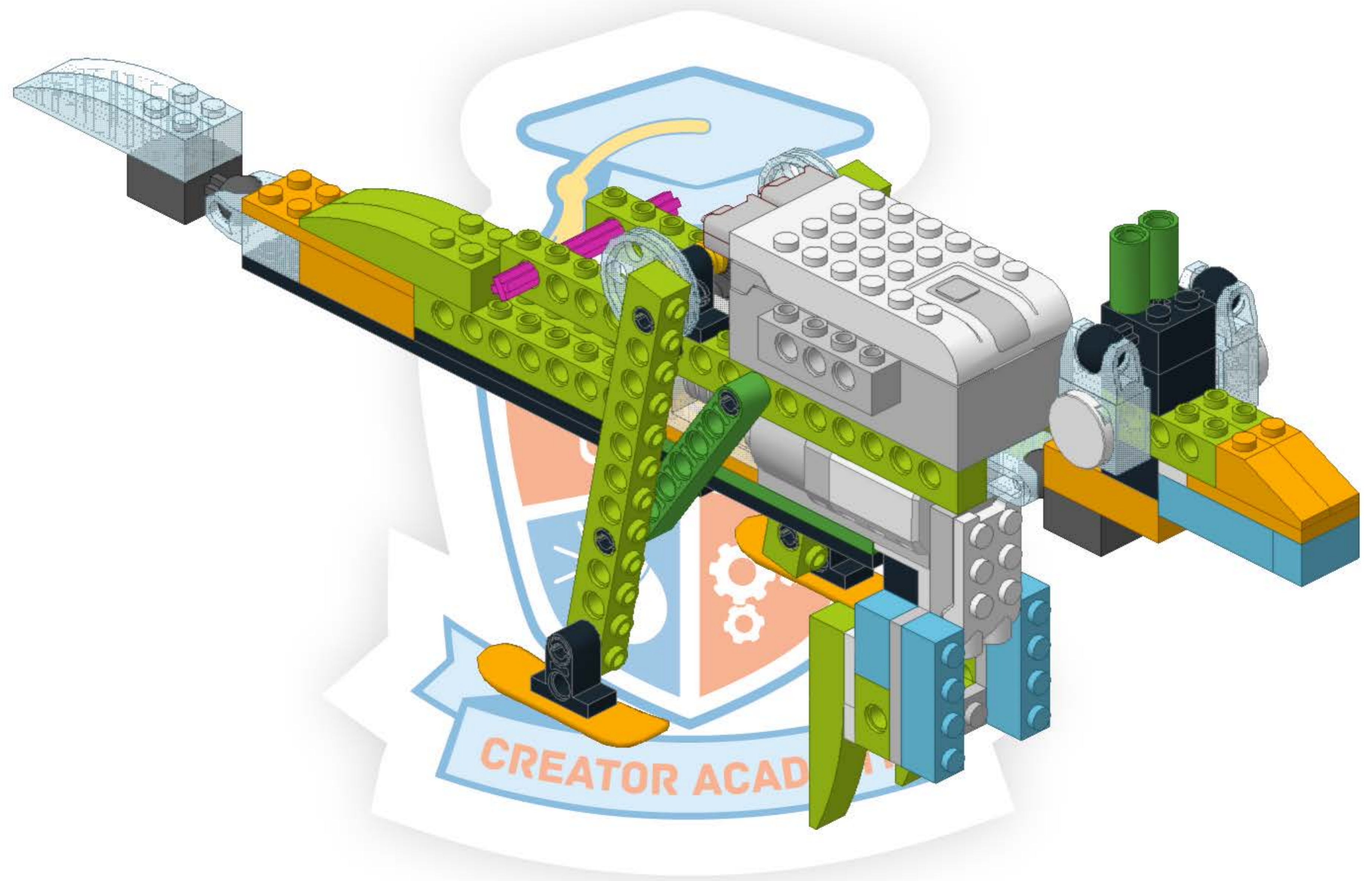



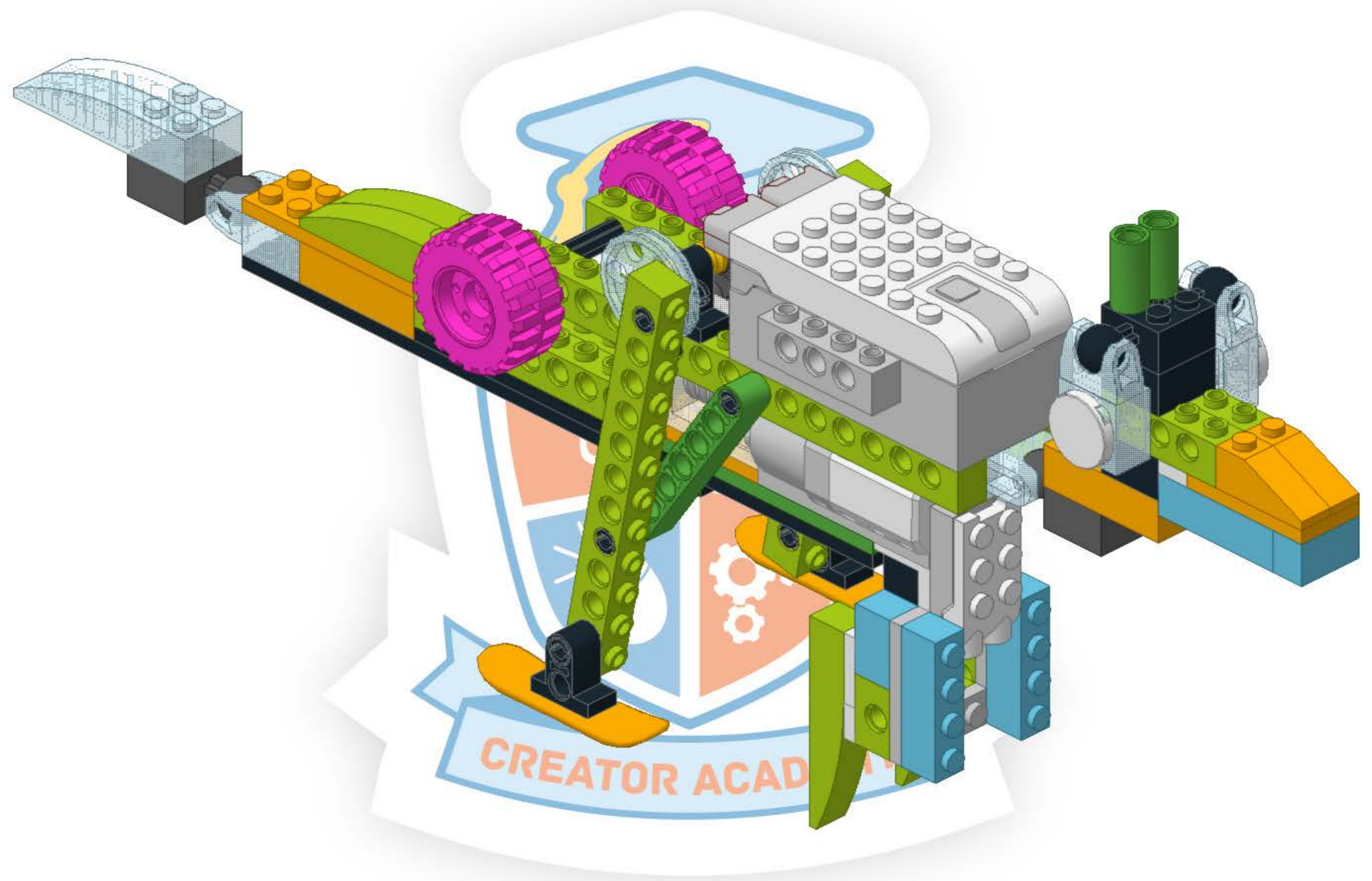

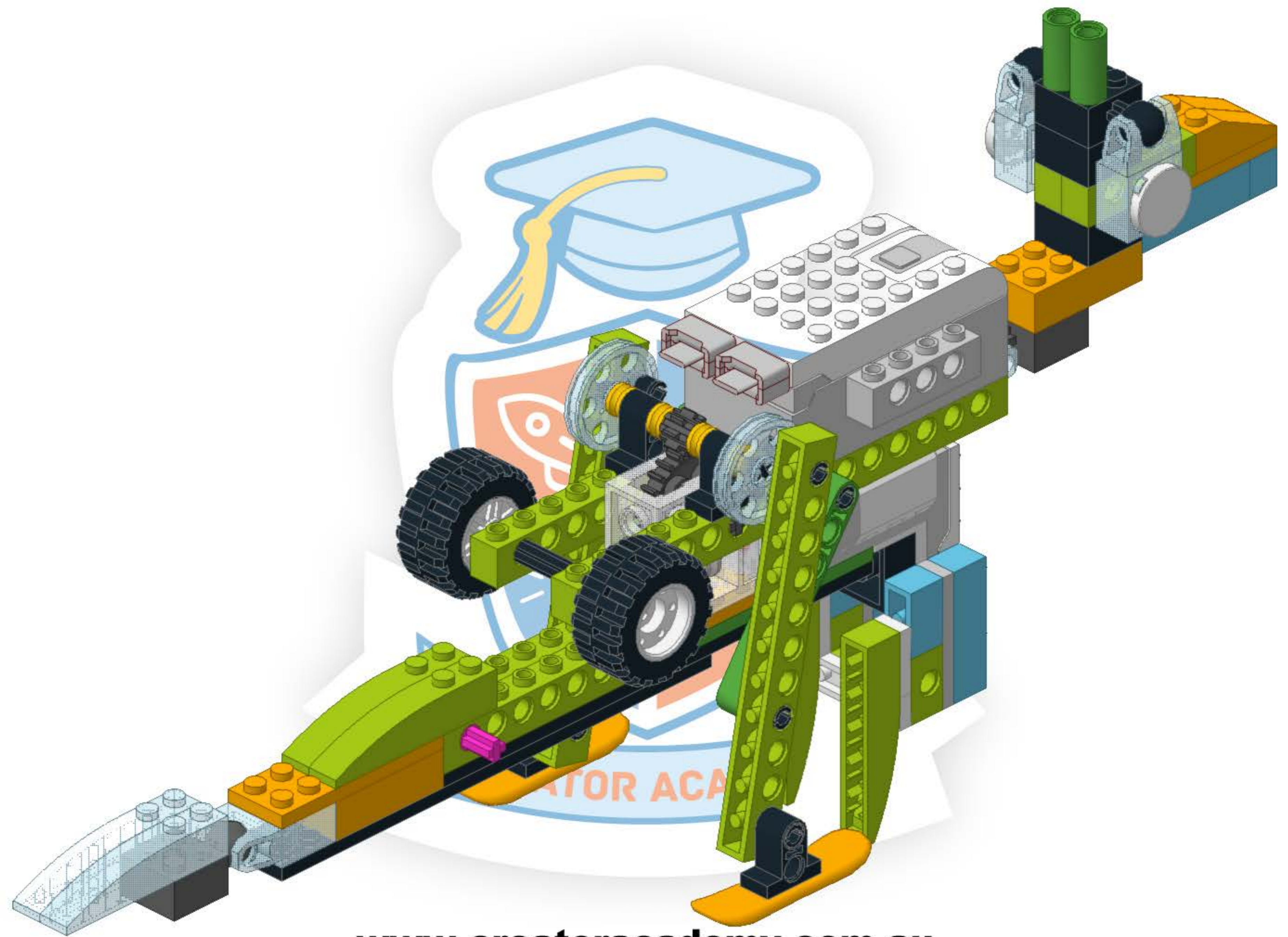
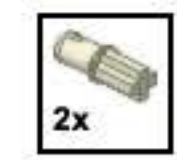

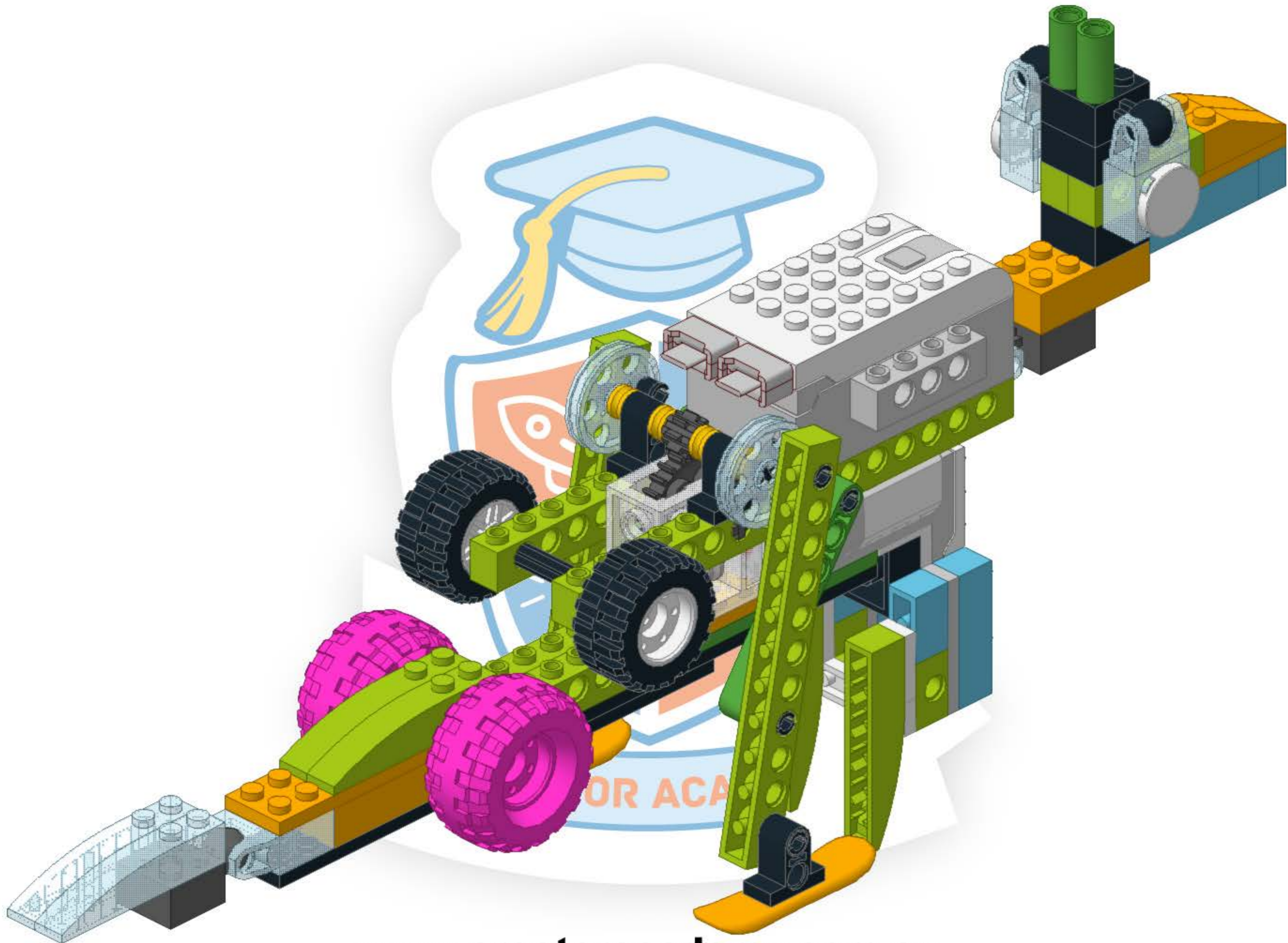



1

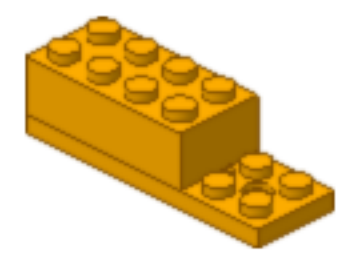
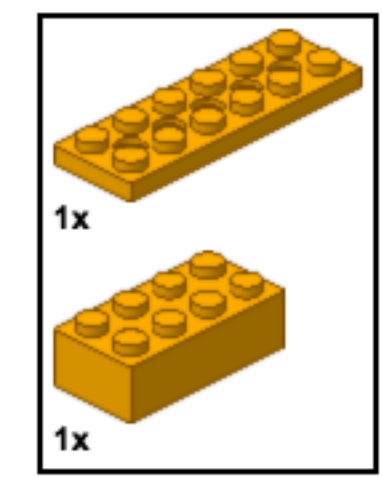

2

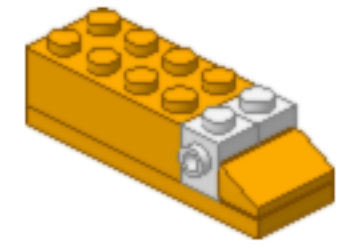
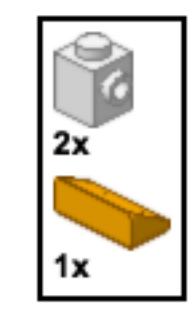

3

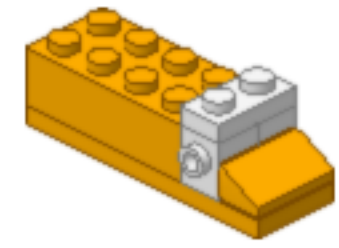
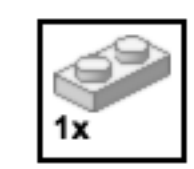

4

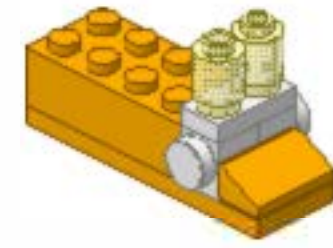





1x



2x



2x



2x

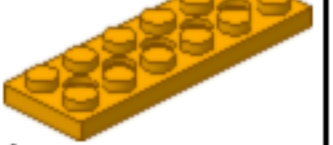

1x



1x



1x

