

APPROVAL FOR USE

For the purpose of killing **stoats, weasels and rats**

Quill 150 Spring Trap

"Where used in a **closed-end trap configuration**, the trap may be used only for the purpose of killing **stoats, weasels and rats**.

The trap must be set in an artificial tunnel constructed to the design specified by Quill Productions using materials suitable for the purpose."

"Where used in a **run-through trap configuration**, the trap may be used only for the purpose of killing **stoats, weasels and rats**.

The trap must be set in a **natural or artificial tunnel** which is, in either case, suitable for the purpose."

FEATURES

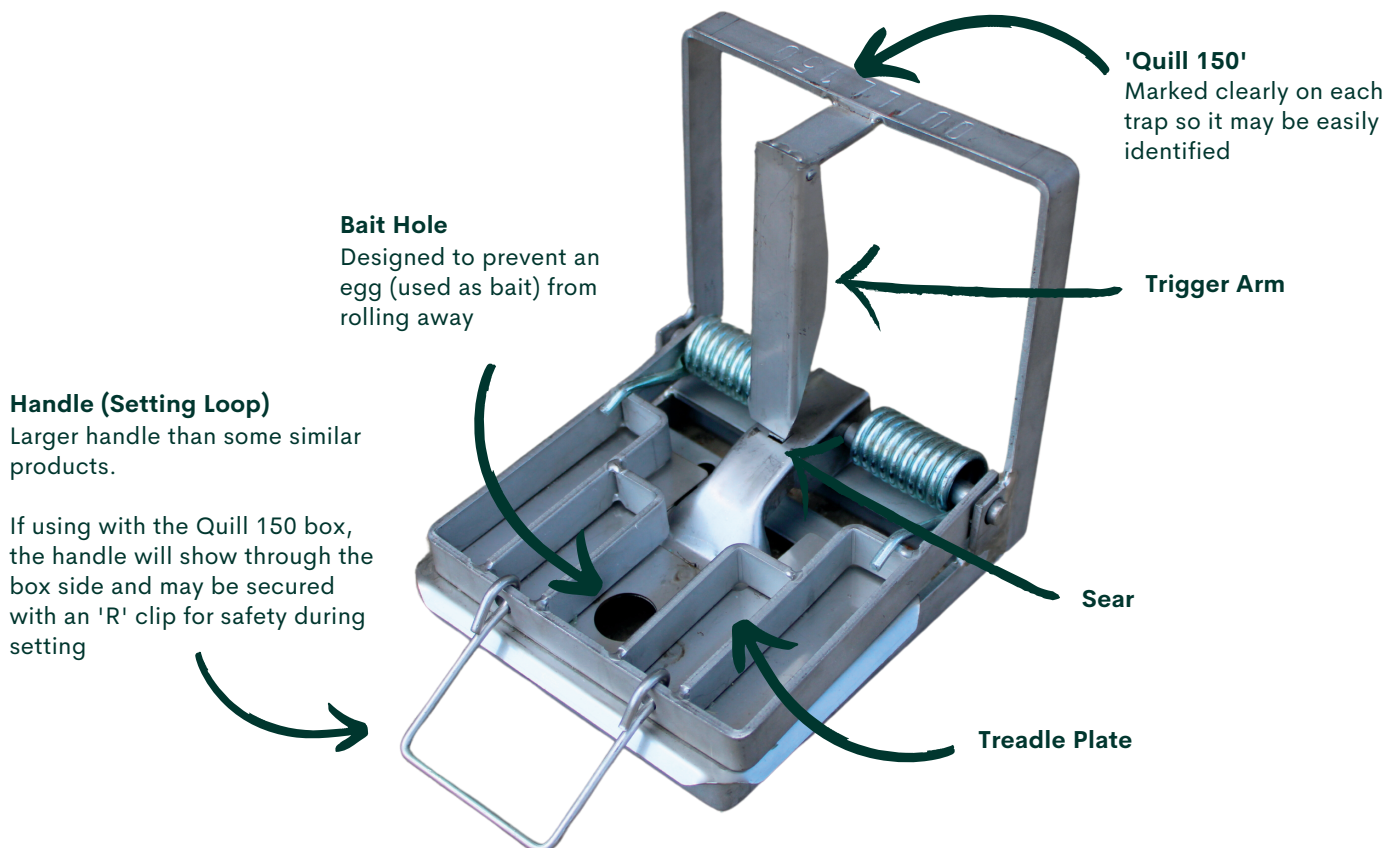

WARNING

In order to kill small mammals humanely, these traps are extremely powerful. They should be considered **VERY DANGEROUS** both once set, and during the setting process.

We strongly advise that tunnels should never be set where small children or pets could have access to them. To ensure a safe grip when setting and unsetting these traps, we recommend that you do **NOT** wear gloves.

The user agrees to use the trap at their own risk. Quill Productions takes no responsibility for any harm caused.

SETTING INSTRUCTIONS

**If not using
Quill 150 Trap Box**

If the Quill 150 Trap is to be used without the Quill 150 Trap Box, these instructions must be followed, to ensure safe and legal use of the trap.

Baffles

The trap must be located in a tunnel with a baffle between the trap and the entrance. A baffle is a vertical piece of material that slows the animal's approach to the trap and guides it onto the correct part, ensuring a humane strike.

The baffle may be made from any suitable material, but its dimensions and placement relative to the trap must comply with the instructions that follow which prescribe the arrangement and aperture size of baffles in each of these types of tunnel.

If a solid material is to be used for the internal baffle, the widest point of the drilled hole should not exceed the maximum permitted width and height measured from where the lowest point of the hole meets the sloping treadle plate when set.

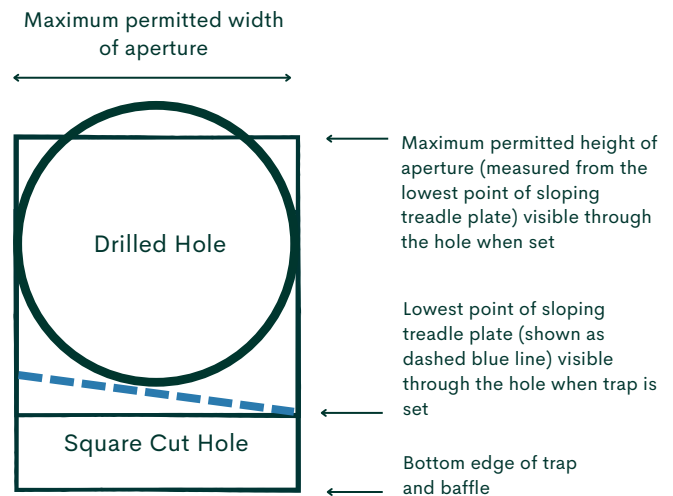

The trap and baffle must be fixed so that their relative positions cannot change.

The gap **between them and the tunnel sides** must be **no more than 10mm**, so that an animal cannot squeeze past, but not be so close as to impede the action of the trap. Similarly, **the gap between the trap and baffle** must be **no more than 10mm** but not be so close as to impede the action of the trap.

The required baffle arrangements differ depending whether the trap is used in:

- A closed-end tunnel
- A run-through tunnel

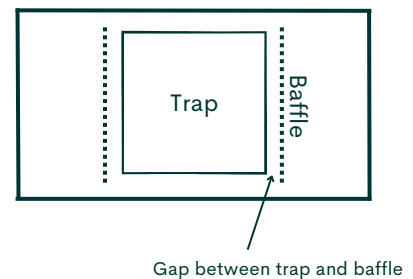

Tunnels & Chassis

The Quill 150 Trap and baffle arrangements can be part of either a complete trap tunnel requiring access to the trap via an opening lid, or a separate rigid 'chassis', which can be slid in and out of a separate tunnel.

Tunnels must be suitable for minimising the chances of capturing, killing or injuring non-target species whilst not compromising the killing or taking of target species. They must also be 'suitable for the purpose' with respect to convenience in operation and human safety.

The trap must be firmly secured to a rigid base, either to the floor of the trap tunnel itself or to the base of separate rigid 'chassis'. Tunnel entrance(s) must be designed to minimise the risk of access by non-target animals. Measures such as using external excluders at the tunnel entrance(s) are usually employed to achieve this.

External excluders can be made of any suitable materials and be of any configuration, which practicably minimises the likelihood of it killing, taking or injuring non-target species, without unreasonably compromising the trap's use.

External and internal apertures should be staggered so a bird or animal reaching into the tunnel, cannot directly access the trap.

SETTING INSTRUCTIONS

If not using
Quill 150 Trap Box

Baffle arrangement in run-through tunnels

For **run-through tunnels**, **two baffles must be used, one each side of the trap**, with their holes aligned, so that approaching animals are slowed and guided over the 'strike area' of the trap whichever direction they approach from. Note that baffle apertures (holes) must be smaller for run-through tunnels than for closed-end tunnels.

For **run-through tunnels**, **baffle holes must be no wider than 51mm (2inch) and no higher than 51mm (2inch)** above the lowest point of the sloping treadle plate, visible through the hole when the trap is set. For the **Quill 150 Trap** the permitted height is about **65mm (2½inch)** measured from the bottom edge of the trap and baffle.

Baffle arrangement in closed-end tunnels

For tunnels with **one end closed**, a **baffle must be used adjacent to the trap**, so that an animal approaching from the tunnel entrance is slowed and guided over the 'strike area' of the trap.

The inner baffle aperture (hole) in **closed-end tunnels** must be **no more than 65mm (2.5 inch) wide and no higher than 65mm (2.5 inch)** above the lowest point of the sloping treadle plate, visible through the hole when the trap is set. This is about 80mm (3¼inch) from the bottom edge of the trap and baffle. Note that this is a larger aperture size than that permitted for run-through inner baffles.

Setting the Trap

If you are using bait in a closed end tunnel put it in place before setting the trap.

(If using a trap box with opening lid, please see 'Setting Instructions - For use WITH The Quill 150 Trap Box')

For safety, we always recommend setting the Quill 150 Trap within the trap box or tunnel.

Position yourself behind the upright part of the trap. Hold the tunnel down with one hand or one knee while pulling up on the wire loop with the other hand to raise the moving jaw of the trap. Once the draw is raised sufficiently, hook the thumb of that hand over the side of the tunnel nearest to you. You can then bring in the other hand to help. Keep both thumbs firmly hooked over the tunnel side whilst setting the trap, to ensure you don't catch your hands should you lose grip.

As the moving jaw is raised, it will push the upper end of the hanging trigger arm, causing the lower end of the arm to flick forwards, then drop back down onto the treadle plate and lodge against the raised part (the sear). The trap is now set.

WARNING: In order to kill small mammals humanely, these traps are extremely powerful. They should be considered **VERY DANGEROUS** both once set, and during the setting process. We strongly advise that tunnels should never be set where small children or pets could have access to them. To ensure a safe grip when setting and unsetting these traps, we recommend that you do **NOT** wear gloves. The user agrees to use the trap at their own risk. Quill Productions takes no responsibility for any harm caused.

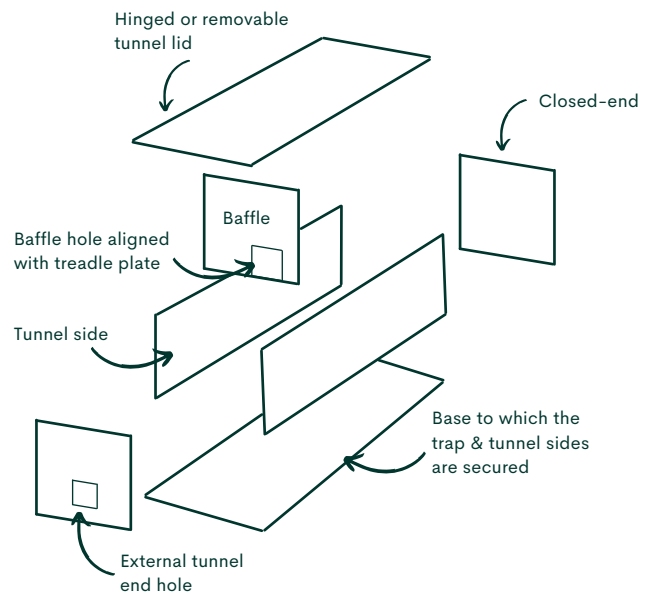
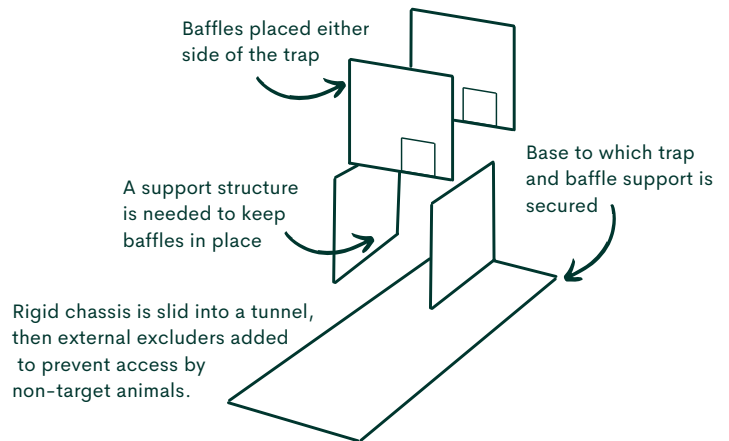

SETTING INSTRUCTIONS

For use with the
Quill 150 Trap Box



1)

Open the lid of the trap tunnel by removing a capped screw using an Allen key (pictured without one capped screw).

Swing the lid to one side once the screw has been removed.

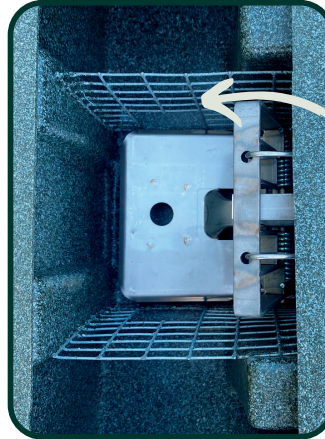

2)

The Quill 150 Trap must be used with the correct baffles, to both exclude larger non-target animals and to direct the target animals for a more humane kill.

The Quill 150 Trap Box is fitted with wire mesh baffles and is ready to use.



3)

Position yourself behind the upright part of the trap. Hold the tunnel down with one hand or one knee while pulling up on the wire loop with the other hand to raise the moving jaw of the trap.

Once the draw is raised sufficiently, hook the thumb of that hand over the side of the tunnel nearest to you. You can then bring in the other hand to help,

Keep both thumbs firmly hooked over the tunnel side whilst setting the trap, to ensure you don't catch your hands should you lose grip.

4)

As the moving jaw is raised, it will push the upper end of the hanging trigger arm, causing the lower end of the arm to flick forwards, then drop back down onto the treadle plate and lodge against the raised part.

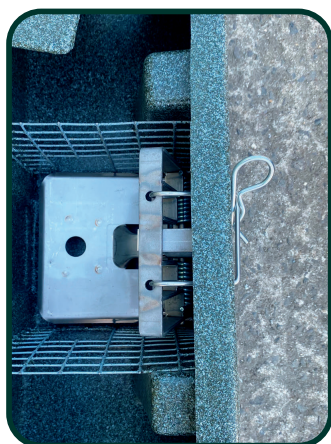
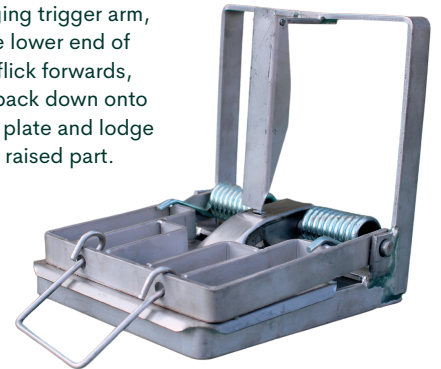

5)

Secure the trap.

Once set, the handle of the trap will show through the side of the Quill 150 Trap Box.

Thread an R Clip through the trap handle in order to secure it

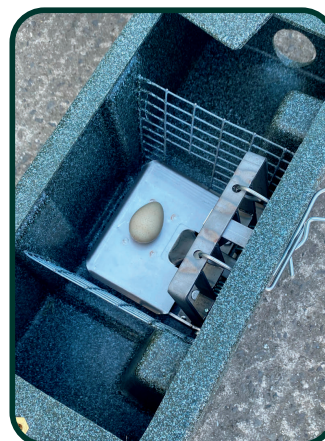

6)

Only when the trap is secure, position your chosen bait in the hole on the base plate of the trap.

This photo shows an egg being used; by placing in the small hole of the trap, it will not roll.



7)

Once you are happy with the position of the bait, remove the R Clip and place it within the trap as shown.

Make sure you position the R Clip facing away from the trap to ensure it does not get in the way of the trap.



8)

Place the lid back into position, using an Allen-key screw to secure the capped screw. The handle will disappear if the trap is set off.

If using other trap box/tunnel:

Carefully close the lid or cover as appropriate.

REMOVING THE ANIMAL FROM TRIGGERED TRAP

Follow steps 1 - 5 above.

For safety, ensure that the trap has been secured well with the R Clip in place on the outside of the box (Picture 5) before removing the animal.