

DiLUSO

Built-in Oven

OV609DDS

OV609DDB

Installation and Operating Manual

CONTENTS

Important Notes -----Page 2

Technical Specification -----Page 4

Installation Instructions -----Page 5

About the Oven -----Page 7

Oven Timer / Clock -----Page 9

Setting Local Time -----Page 9

Program Cooking -----Page 9

Alarm -----Page 10

Oven Cooking Function -----Page 11

Cooking Time -----Page 13

Cleaning and Maintenance -----Page 15

Warnings -----Page 18

Troubleshooting-----Page 19

Important Notes

Dear Customer

Thank you for buying DILUSSO Built-in Oven. Before unpacking it, please read these instructions carefully. Only then will you be able to operate your appliance safely and correctly. Warmly recommend retain the instruction manual and installation instructions for future use or for subsequent owners.

The appliance is only intended to be fitted in a kitchen. Observe the special installation instructions.

Check the appliance if there is any damage after unpacking it. Do not connect the appliance if it has been damaged.

Only a licensed professional may connect appliances without plugs. Damage caused by incorrect connection is not covered under warranty. Only use this appliance indoors. The appliance must only be used for the preparation of food and drink. The appliance must be supervised during operation. This appliance may be used by children over the age of 8 and by persons with reduced physical, sensory or mental capabilities or by persons with a lack of experience or knowledge if they are supervised or are instructed by a person responsible for their safety how to use the appliance safely and have understood the associated hazards. Children must not play with, on, or around the appliance. Children must not clean the appliance or carry out general maintenance unless they are at least 8 years old and are being supervised.

Keep children below the age of 8 years old at a safe distance from the appliance and power cable.

And please always slide accessories into the cavity the right way round.

WARNING

Risk of electric shock!

1. Incorrect repairs are dangerous. Repairs may only be carried out and damaged power cables replaced by one of our trained after-sales technicians. If the appliance is defective, unplug the appliance from the mains or switch off the circuit breaker in the fuse box. Contact the aftersales service.
2. The cable insulation on electrical appliances may melt when touching hot parts of the appliance. Never bring electrical appliance cables into contact with hot parts of the appliance.
3. Do not use any highpressure cleaners or steam cleaners, which can result in an electric shock.
4. A defective appliance may cause electric shock. Never switch on a defective appliance. Unplug the appliance from the mains or switch off the circuit breaker in the fuse box. Contact the after-sales service.

Risk of burns!

1. The appliance becomes very hot. Never touch the interior surfaces of the appliance or the heating elements.
2. Always allow the appliance to cool down.
3. Keep children at a safe distance.
4. Accessories and ovenware become very hot. Always use oven gloves to remove accessories or ovenware from the cavity.
5. Alcoholic vapors may catch fire in the hot cooking compartment. Never prepare food containing large quantities of drinks with high alcohol content. Only use small quantities of drinks with high alcohol content. Open the appliance door with care.

Risk of scalding!

1. The accessible parts become hot during operation. Never touch the hot parts. Keep children at a safe distance.
2. When you open the appliance door, hot steam can escape. Steam may not be visible, depending on its temperature. When opening, do not stand too close to the appliance. Open the appliance door carefully. Keep children away.
3. Water in a hot cavity may create hot steam. Never pour water into the hot cavity.

Risk of injury!

1. Scratched glass in the appliance door may develop into a crack. Do not use a glass scraper, sharp or abrasive cleaning aids or detergents.
2. The hinges on the appliance door move when opening and closing the door, and you may be trapped. Keep your hands away from the hinges.

Risk of fire!

1. Combustible items stored in the cavity may catch fire. Never store combustible items in the cavity. Never open the appliance door if there is smoke inside. Switch off the appliance and unplug it from the mains or switch off the circuit breaker in the fuse box.
2. A draught is created when the appliance door is opened. Greaseproof paper may come into contact with the heating element and catch fire. Do not place greaseproof paper loosely over accessories during preheating. Always weight down the greaseproof paper with a dish or a baking tin. Only cover the surface required with greaseproof paper. Greaseproof paper must not protrude over the accessories.

Hazard due to magnetism!

Permanent magnets are used in the control panel or in the control elements. They may affect electronic implants, e.g. heart pacemakers or insulin pumps. Wearers of electronic implants must stay at least 10 cm away from the control panel.

Causes of Damage

1. Accessories, foil, greaseproof paper or ovenware on the cavity floor: do not place accessories on the cavity floor. Do not cover the cavity floor with any sort of foil or greaseproof paper. Do not place ovenware on the cavity floor if a temperature of over 50 °C has been set. This will cause heat to accumulate. The enamel will be damaged.
2. Aluminum foil: Aluminum foil in the cavity must not come into contact with the door glass. This could cause permanent discoloration of the door glass.
3. Silicone pans: Do not use any silicone pans, or any mats, covers or accessories that contain silicone. The oven sensor may be damaged.
4. Water in a hot cooking compartment: do not pour water into the cavity when it is hot. This will cause steam. The temperature change can cause damage to the enamel.
5. Moisture in the cavity: Over an extended period of time, moisture in the cavity may lead to corrosion. Allow the appliance to dry after use. Do not keep moist food in the closed cavity for extended periods of time. Do not store food in the cavity.

6. Cooling with the appliance door open: Following operation at high temperatures, only allow the appliance to cool down with the door closed. Do not trap anything in the appliance door. Even if the door is only left open a crack, the front of nearby furniture may become damaged over time. Only leave the appliance to dry with the door open if a lot of moisture was produced while the oven was operating.
7. Fruit juice: when baking particularly juicy fruit pies, do not pack the baking tray too generously. Fruit juice dripping from the baking tray leaves stains that cannot be removed. If possible, use the deeper universal pan.
8. Extremely dirty seal: If the seal is very dirty, the appliance door will no longer close properly during operation. The fronts of adjacent units could be damaged. Always keep the seal clean.
9. Appliance door as a seat, shelf or worktop: Do not sit on the appliance door or place or hang anything on it. Do not place any cookware or accessories on the appliance door.
10. Inserting accessories: depending on the appliance model, accessories can scratch the door panel when closing the appliance door. Always insert the accessories into the cavity as far as they will go.
11. Carrying the appliance: do not carry or hold the appliance by the door handle. The door handle cannot support the weight of the appliance and could break.
12. If you use the residual heat of the switched off oven to keep food warm, a high moisture content inside the cavity can occur. This may lead to condensation and can cause corrosion damage of your high quality appliance as well as harm your kitchen. Avoid condensation by opening the door or use “Defrost” mode.

IMPORTANT! THE APPLIANCE MUST BE CONNECTED IN ACCORDANCE WITH CURRENT ELECTRICAL RULES AND REGULATIONS. INSTALLATION IS TO BE DONE ONLY BY AN AUTHORISED ELECTRICIAN.

WARNING! THIS APPLIANCE MUST BE EARTHED.

IMPORTANT! AN ISOLATION SWITCH COMPLETE WITH A 15A PLUG SOCKET MUST BE INCORPORATED IN THE FIXED WIRING.

Technical Specifications

| | |
|---------------|------------------------------|
| Product | : OV609DDS / OV609DDB |
| Voltage | : (220 – 240) Vac |
| Frequency | : 50Hz-60Hz |
| Maximum Power | : 2300W |
| Oven Capacity | : 82 litres |
| Power Cable | : 15A plug |

Before connecting to the mains, make sure that:

- The electric meter, safety valve, feeding line and socket are adequate to withstand the maximum load required (refer to product data label for maximum load).
- The supply system earth tested to ensure its working properly.
- The isolation switch can easily be reached after the oven is installed.
- Never use reductions, shunts, and adaptors as they can cause overheating or burning.
- The supply cable is positioned so that it not exposed to temperatures exceed 50°C.

The manufacture shall not liable for any direct or indirect damage caused by faulty installation. The installer must ensure that the product installation and connection complies with the local and general regulation in force.

Installation Instruction

IMPORTANT! ENSURE THE POWER IS SWITCHED OFF DURING INSTALLATION OR MAINTAINANCE

Built in Dimension

Damage caused by incorrect installation may void the warranty. Please wear protective gloves to prevent injury during installation. Check the appliance for any damage before installation. Do not install the appliance if there is and contact the place of purchase.

Before turning on the appliance please clean up all the packaging materials and adhesive film from the appliance. The dimensions attached are in mm.

Warning! The appliance must not be installed behind a decorative door to avoid overheating.

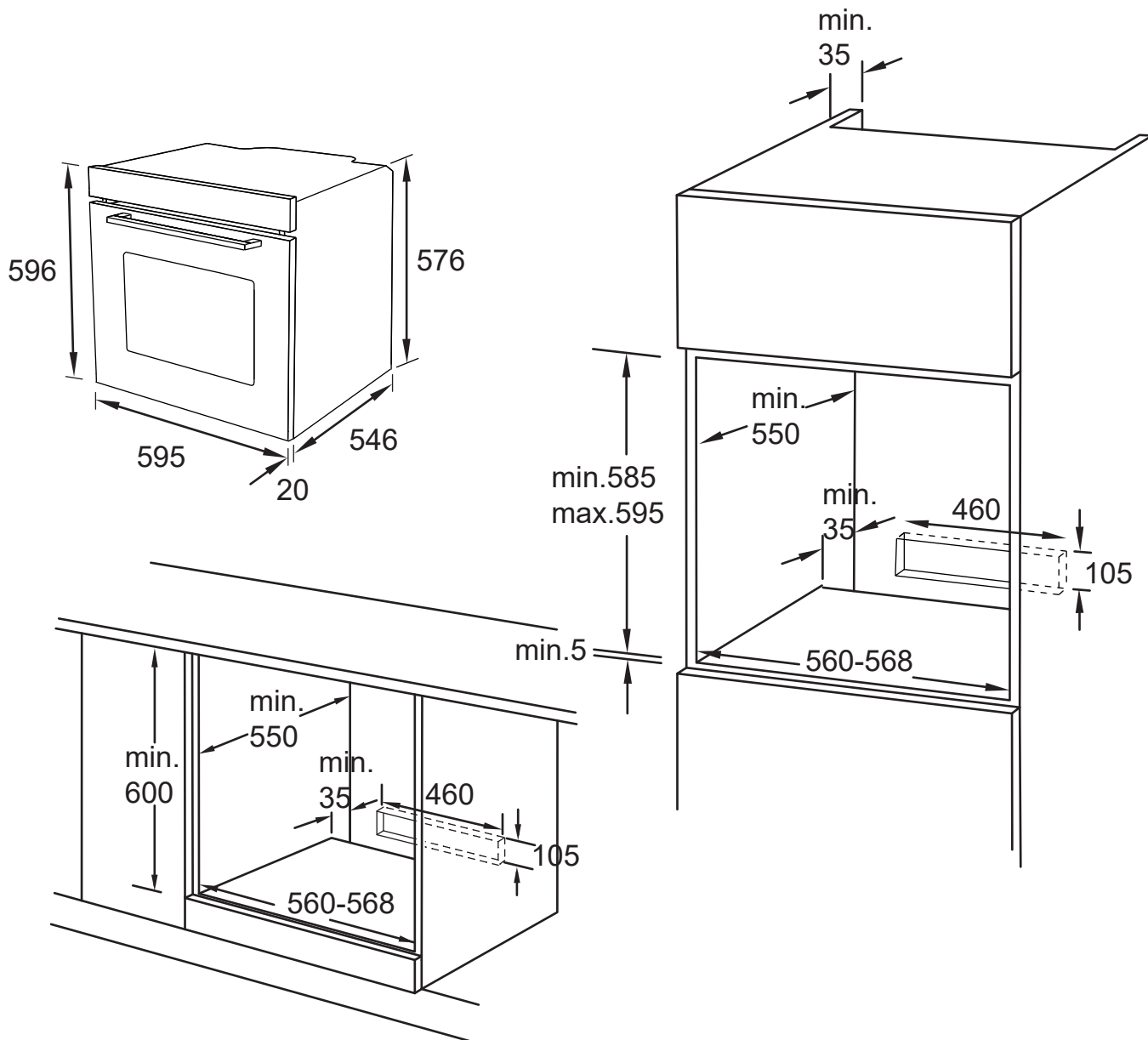

Before using the oven for the first time, we suggest to:

- Remove the protective film covering the oven door glass (if any)
- Remove all removable accessories, trays & racks and wash them with dishwashing detergent and dry.
- Ensure that the cavity does not contain any leftover packaging, such as polystyrene pellets or wooden particles which may cause risk of fire.
- Set the conventional heating function to heat the empty oven at max. temperature for 60 minutes. This is to remove any unpleasant smell caused by working residues. It may also emit some smoke, which is normal and will stop after a while. Keep the kitchen highly ventilated.
- Let the oven cool down and clean the internal cavity of the oven with soapy water and wipe it dry.
- Reinstall the side racks.

Settings :

| | |
|------------------|---|
| Cooking Function |  |
| Temperature | 250°C |
| Duration | 1 hour |

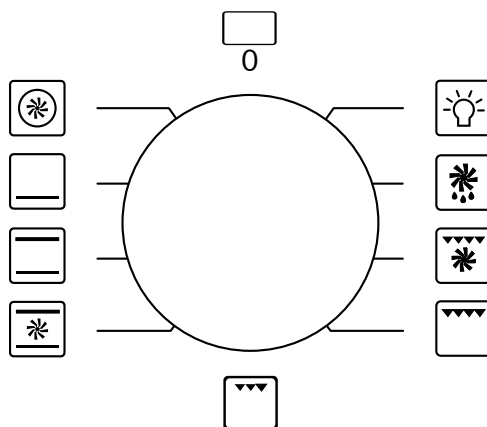

Use the left control knob to select the suitable cooking function.
Turn the temperature knob to point to the desired temperature.

IMPORTANT!

WHEN THE OVEN IS IN OPERATION, THE OVEN DOOR MAY BECOME HOT TO TOUCH. TO PREVENT INJURY OR BURNS TAKE CARE WHEN USING IT.

MAKE SURE CHILDREN DO NOT GO NEAR THE OVEN WHEN IN USE.

About The Oven

Note : To make the appliance cools down more quickly after the operation, the cooling fan may continue to run for a period afterwards.

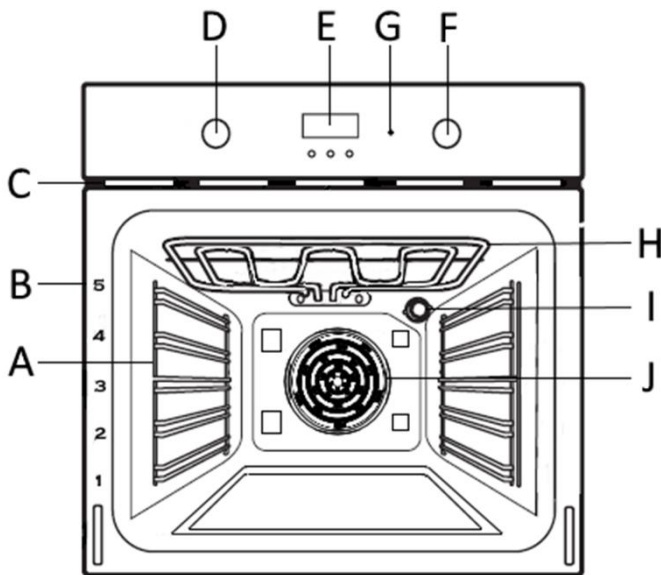

- A - Slider Bracket
- B - Tray Level Marking
- C - Cooling Fan Vent
- D - Function Knob
- E - Oven Timer/Clock
- F - Temperature Knob
- G - Temperature Indicator
- H - Upper Heating Element
- I - Oven Light
- J - Oven Fan

Knob : Turn the knobs to set operating mode and temperature.

Indicator light : The indicator light will be on and off intermittently during the operation of the appliance to indicate if the heating elements are in operation.

Oven light : when you switch the appliance on to any mode, the light will illuminate.

Cooling fan : The cooling fan switches on and off as required. Hot air is released from the vents above the door.

Note: In case of any differences between the appliance and the pictures in this manual, the product shall prevail.

Oven Accessories

Your appliance is accompanied by a range of accessories.

Here you can find an overview of the accessories included and information on how to use them correctly.

Your appliance is equipped with the following accessories :

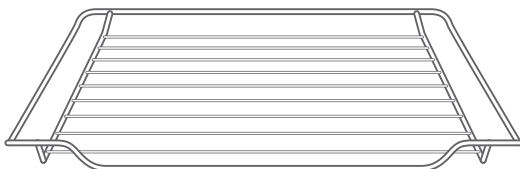

Wire Rack

For ovenware, cake tins and ovenproof dishes.
For roasts and grilled food.

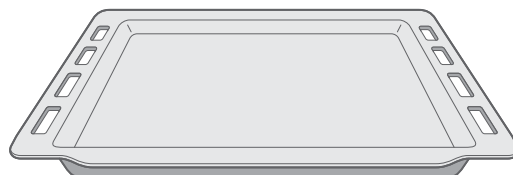

Baking Tray

For tray bakes and small baked products.

Only use original accessories. They are specially adapted for your appliance.

Additional accessories maybe available for purchase from your retailer or the after sales care team.

Note : The accessories may deform when they become hot. This does not affect their function. Once they are cooled down again, they regain their original shape.

Inserting accessories

The cavity has five shelf positions. The shelf positions are counted from the bottom up. The accessories can be pulled out approximately halfway without tipping.

Ensure that you always insert the accessories into the cavity the right way round. Always insert the accessories fully into the cavity so that they do not touch the appliance door.

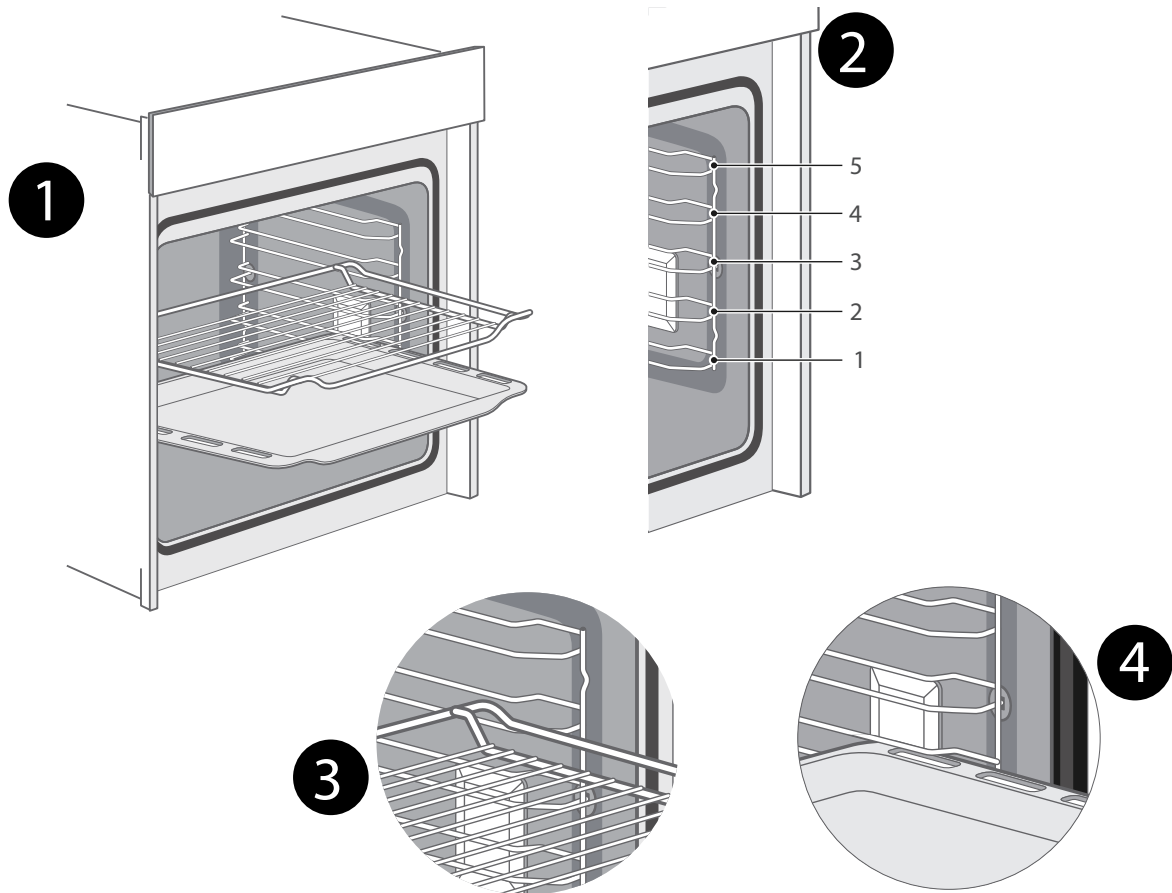

Rack safety

The baking accessories can be pulled out approximately halfway until they lock in place. The safety feature prevents the baking accessories from tilting when they are pulled out. The accessories must be inserted into the cavity correctly for the safety feature to work properly. When inserting the wire rack, ensure the wire rack is facing the right way as per the picture 1 & 3.

When inserting the baking tray, ensure the baking tray is facing direction as per picture 1 & 4.

Oven Timer/Clock

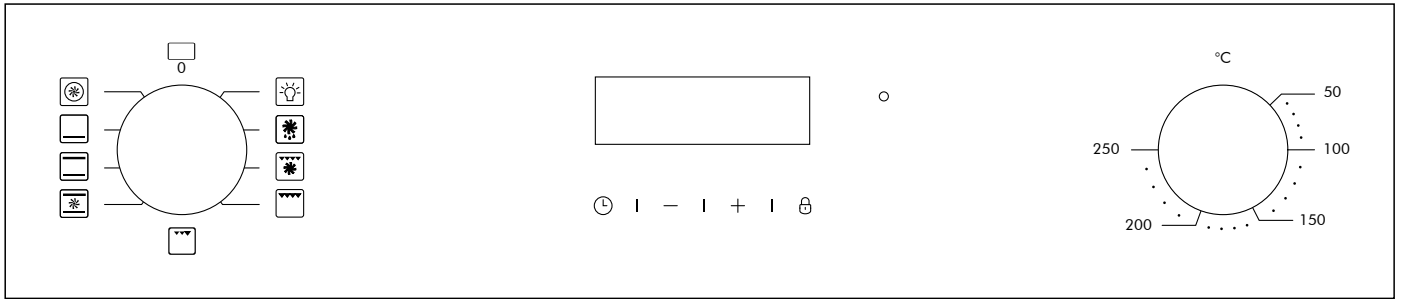

When the electrical power supply is first switched on, the digital display automatically flashing "0:00", press any button to quit.

Timer setting button  sequence : Local time display → Alarm → Cooking duration → Local time setting → Local time display (Note: Local time display is shown by default)

To set the local time

This is 24 hour clock, for example 2:30pm is shown as 14:30.

Step 1, Press  several times until the clock icon is flashing on the display.

Step 2, Press "+" or "-" buttons to adjust the hour setting. Press and hold the "+" or "-" buttons for quick adjustment.

Step 3, Wait for 5 seconds to confirm the selection and local time is displayed. Clock icon will turn off.

The time has now been set and timer will be in standby mode.

Note : If local time setting is changed after setting alarm, cooking duration or cooking end time, the alarm will remain and not change, but cooking duration and cooking end time will reset.

Program Cooking - Setting cooking duration

Step 1, Press  several times until the cooking duration icon is flashing and "0:00" is on the display.

Step 2, Press "+" or "-" buttons to adjust the required cooking duration, adjustable range is "0:01" to "23:59". Press once for 1sec increments or hold for 3 seconds for faster adjustments.

The flashing will last for 5 seconds so the settings must be done within this time frame or the local time will display again. After setting, the cooking duration icon will light up, counting down starts and oven starts cooking.

When counting down stops at the end of cooking duration, the oven gives out an audible signal twice every 5 seconds for 2 minutes and the oven turns off automatically. Cooking duration icon will flash and "0:00" will

display. Press any button to stop. Press  to show local time display.

Note : During cooking duration, press  to change the cooking duration setting.

Setting the Timer / Alarm

This function does not interrupt cooking and does not affect the oven; it is simply used to give out an audible signal when the set amount of time has elapsed.

Step 1, Press  button until you see the alarm icon flashing, and "0:00" on the timer display,

Step 2, Press "+" or "-" buttons to adjust the duration. Press once for 1 sec increments or hold for 3 seconds for faster adjustments. Setting range is from "0:01" to "23:59". Wait for 5 seconds to confirm setting and the alarm symbol is now lights up continuously on the timer display, alarm starts.



When the set time has elapsed the oven gives out an audible signal.

The signal will continue sounding for 2 minute. Press any button to stop.

Additional notes on the Oven Timer / Clock

- If the alarm, cooking duration and end time settings are done, alarm time will be display while alarm, cooking duration, and end time icons will display.
- After the alarm, cooking duration and end time settings are done, if required, press  to check and change alarm time, cooking duration, end time or local time.
- If cooking duration is later than alarm, there will be buzzing only for the alarm. If cooking duration is earlier than alarm, there will only be buzzing for alarm.

Child Lock

Press the  button for 3 seconds to activate the lock function, the icon will display. Press the  button for 3 seconds again to unlock. The icons turn off. Whilst locked the alarm will sound if any buttons are pressed and the lock icon will flash for 3 seconds.

Indicator

The indicator light will turn on when the appliance is initially turned on. It will be turn off when the set temperature is reached. During cooking the light will turn on and off intermittently as the heating elements adjust to maintain the set temperature.

Oven Cooking Function

The below outlines the available operating functions of the oven and suggested uses for each function. All functions will start working after the temperature is set by using the temperature knob.

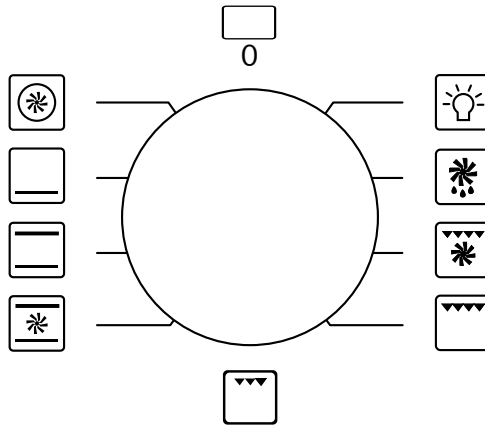

Oven Light – To illuminate the cavity without the heating element operating.



Defrost – To defrost frozen food.



Full Grill + Fan – Temperature range 50°C to 250°C

For roasting poultry, fish and larger pieces of meat. The heating element and the fan switch on and off alternately. The fan circulates the hot air around the food.



Full Grill – Temperature range 50°C to 250°C

For grilling flat items such as steak, sausages, toast etc.



Half Grill – Temperature range 50°C to 250°C

For grilling smaller portions of food.



Conventional – Temperature range 50°C to 250°C

For traditional baking and roasting on one level. Especially suitable for meringue, pastries etc



Fan Assist – Temperature range 50°C to 250°C

For baking and roasting where you want browning on the top and crispy bottom. The fan distributes heat from heating elements evenly around the cavity.



Bottom Heat – Temperature range 50°C to 250°C

For preparing pizza and dishes which require heat from underneath.



Fan Forced – Temperature range 50°C to 250°C

The rear circular heating element and fan comes into operation to distribute heat evenly to all levels. Ideal for multi-level baking or roasting.

Caution!

If you open the appliance door during on-going operation, the operation will not be paused. Please be extra careful with the risk of burns.

Do not cover the ventilation vents. Otherwise the appliance may overheat. The cooling fan may continue to run for a period of time after the oven is turned off to cool down the cavity.

After the appliance is switched off, it will still be very hot especially inside the cavity. Never touch the interior surfaces of the appliance or the heating elements. Use oven gloves to remove accessories or ovenware from the cavity, and allow the appliance to cool down. Keep children at a safe distance at all times to avoid risk of injury.

General Advise

The oven offers various kind of heating:

1. The conventional heating for the cooking of special roasts
2. The fan forced heating for the cooking of cakes, biscuits and similar.

If the fan heating is chosen, it is recommended to take advantage of it by cooking on more levels to prepare a complete menu, to save time and energy.

Fan heating



By this function a continuous circulation of warm air is created, suitable for the cooking on multiple levels. The oven will reach the preset temperature in a very short time.

Conventional heating (the upper and lower heating element operate)



It is especially suitable for the cooking of game and as well as for the cooking of bread and sponge cakes. It is advisable to place food into the oven after preheating it.

Grill Cooking (the two upper heating elements works)



To cook with the grill, pre-heat the oven for about 5 minutes. During grill operation the heat comes from above; and it is suitable for thin cuts meat and for toasts. The table shows some examples of cooking times and shelf positions. The cooking times vary according to the type of food, its homogeneity and volume.

Cooking Of Pastry

The air circulation of the oven assures an instantaneous and uniform heat distribution. More trays can be inserted into the oven together with the pastries, taking care not to use the top level. Together with the pastry, other foods can be cooked at the same time (fish, meat, etc.), provided they can be cooked at the same temperature.

Gratinating (use either the inner upper element or both inner outer upper elements)

“Gnocchi alla romana”, polenta pasticciata, rice, lasagnas, noodles and vegetables dressed with béchamel are typical preparation for this type of cooking.

Pizza or Focaccia

Use a light aluminium tray with a maximum diameter of 30cm, placing it on top of the rack supplied. If the pizza has a lot of toppings, it is recommended to add the mozzarella cheese on top of the pizza halfway through the cooking process.

Energy saving tips:

1. Remove all accessories which are not necessary during the cooking & baking process.
2. Do not open the door during cooking & baking process.
3. If you open the door during cooking & baking, switch the model to “Oven Light” without changing the temperature setting.
4. Decrease the temperature setting in non fan assisted modes to 50°C at 5 to 10 mins before end of cooking time. By doing so you can use the cavity heat to complete the cooking process.
5. Use “Fan Assist” mode whenever is possible. You can reduce the temperature by 20°C to 30°C.
6. Multiple level cooking is possible for “Fan Assist” mode.
7. If it is not possible to cook and bake different dishes at the same time, you can heat one after another to utilise the oven preheat status.
8. Do not preheat the empty oven if its not required. If preheat is necessary, put the food into the oven immediately after reaching the temperature indicated by dimming of the indicator light.
9. Do not use reflective foil, like aluminium foil to cover the cavity floor.
10. Use the timer and/or temperature probe whenever possible.
11. Use dark matt finish and light weighted baking moulds and containers. Try not to use heavy accessories with shiny surfaces, such as stainless steel or aluminium.

Cooking Time

The table shows some examples for the adjustment of the thermostat and of the cooking time.

*The cooking times can vary according to the type of food, its homogeneity and volume.

*For the beef, veal, pork and turkey roasts, with bones or rolled, add about 20 minutes to the times shown in the table.

*The times indicated in the table refer to the cooking of one dish only; for multiple dishes, the cooking times should be increased by 5-10 minutes.

| Nature of food | Oven Temp. °C | Time Minutes |
|-----------------------|----------------------|---------------------|
| General | 220--250 | Relative to Qty |
| Long-cooking roast | 225--250 | 50--60 |

| | | |
|-------------|----------|-----------------|
| Fowl (duck) | 210--250 | 150--180 |
| Poultry | 225--250 | 50--60 |
| Game | 200--225 | Relative to Qty |
| Fish | 180--200 | 20--25 |
| Pastries | 160--200 | 60--70 |

| Food | Qty. Kg | Temp. °C | Pre-heat time in minutes | Time in min. |
|--------------------------|------------|-------------|-----------------------------|--------------------|
| Veal cutlet | 1 | 250 | 5 | 8--10 |
| Lam cutlet | 1 | 250 | 5 | 12--15 |
| Liver | 1 | 250 | 5 | 10--12 |
| Chopped meat roulades | 1 | 250 | 5 | 12--15 |
| Veal heart | 1 | 250 | 5 | 12--15 |
| Roast in the net | 1 | 250 | 5 | 20--25 |
| Half-chicken | 1 | 250 | 5 | 20--25 |
| Fish filet | 1 | 250 | 5 | 12--15 |
| Stuffed tomatoes | 1 | 250 | 5 | 10--12 |

Cleaning and Maintenance

CAUTION!

PRIOR TO CLEANING OR MAINTAINANCE, ALWAYS DISCONNECT THE POWER SUPPLY.

Risk of surface damage

Do not use

1. Harsh or abrasive cleaning agents.
2. Cleaning agents with high alcohol content.
3. Hard scouring pads or cleaning sponges.
4. High pressure cleaners or steam cleaners.
5. Special cleaners for cleaning the appliance while it is hot.

Wash new sponge cloths thoroughly before use.

IMPORTANT!

REGULARLY CHECK THE CONDITION OF THE SILICONE DOOR SEAL. CLEAN IF NECESSARY AND AVOID USING ABBRASIVE CLEANERS. SHOULD IT BE DAMAGED CONTACT THE AFTER SALES SERVICE CENTRE.

1) CLEANING OF STAINLESS STEEL

In order to have your oven retains its new appearance; regular cleaning and care should be performed to protect the s/steel finishes.

Never use gritty or abrasive sponges. Stubborn stains can be removed by soaking in hot water, standard stains can be removed by applying a clean cloth soaked in soapy water before spillage becomes cold or dries up. Acidic materials like vinegar and citric juices etc can damage the most resistant surfaces. If a spill occurs wipe it immediately.

Note : Use only damp cloth to clean the stainless steel panel with printed wording. Stainless steel cleaners and similar products may remove the print.

2) OVEN CAVITY CLEANING

Oven spillages should be cleaned straight away. Leaving it will cause burning and smoking inside the chamber of oven the next time oven is used. Leaving spillage's can cause permanent damage to the enamel thus making it extremely hard to remove in the future. A non-caustic cleaner is recommended to clean the chamber of the oven. Do not use abrasive scourers, sponges, cleaning products. Wipe out oven regularly and properly while oven is still warm with hot soapy water and a soft cloth.

3) TOP HEATING ELEMENT

This element must never be sprayed with any detergents. A damp cloth and a bottlebrush can be used to clean the roof of the oven and the element itself. Never soak the element and always dry it after cleaning as not doing so can lead to deterioration. This area should be cleaned regularly as cooking fats spit up and stick to the ceiling and the element which will burn and smoke, giving out unpleasant odours.

4) CLEANING OF OVEN DOOR

Clean the glass door by using damp cloth and dry it. Do not use harsh abrasive cleaners or sharp metal scrapers to clean the oven glass door as they may scratch the surface and cause glass shattering.

5) REMOVING THE OVEN DOOR

To make it easier to clean the oven chamber, the oven door could be removed.

The appliance door hinges each have a locking lever. When the locking levers are closed, the appliance door is secured in place. It cannot be detached. When the locking levers are opened, you may detach the appliance door.

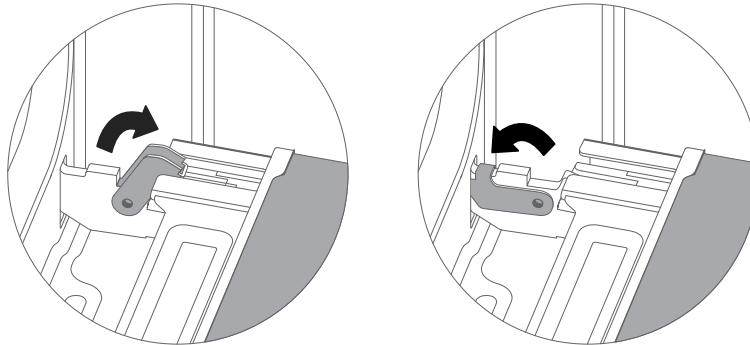

Risk of injury!

- If the hinges are not locked, they can snap shut with great force. Ensure that the locking levers are always fully closed or, when detaching the appliance door, fully open.
- The hinges on the appliance door move when opening and closing the door. Keep your hands away from the hinges.

To remove the oven door, first open the appliance door fully. Fold open the two locking levers on the left and right. Close the appliance door as far as the limit stop. With both hands, grip the door on the left and right hand side, and pull it out upwards.

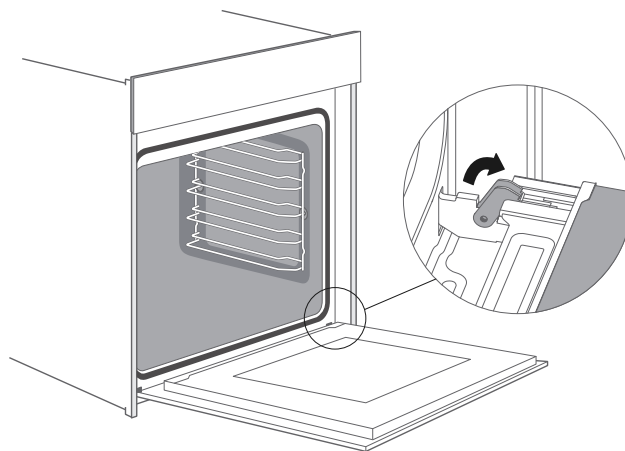

Re-fitting the appliance door in the opposite sequence to removal.

When attaching the appliance door, ensure that both hinges are placed right into the installing holes at the front panel of the cavity. Ensure that the hinges are inserted into the correct position. You must be able to insert them easily and without resistance. If you can feel any resistance, check that the hinges are inserted into the holes properly.

Open the appliance door fully. If you are unable to fully open the door, double check the hinges are in the right position by referereng the the above step. Fold both locking levers closed again. Close the oven door. Ensure the air vents are not covered up. Please remove and refit the door if they are covered.

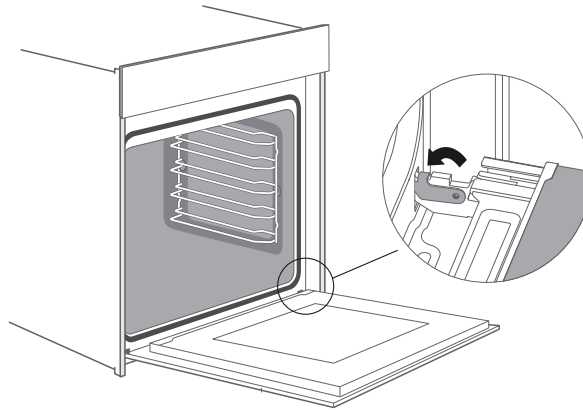

Removing the door cover

The door cover can be removed for thorough cleaning. First remove the appliance door as per above instructions. Then press on the right and left side of the cover. Remove the cover. After cleaning, put the cover back in place and press on it until it clicks audibly into place. Re-fit the appliance door and close it.

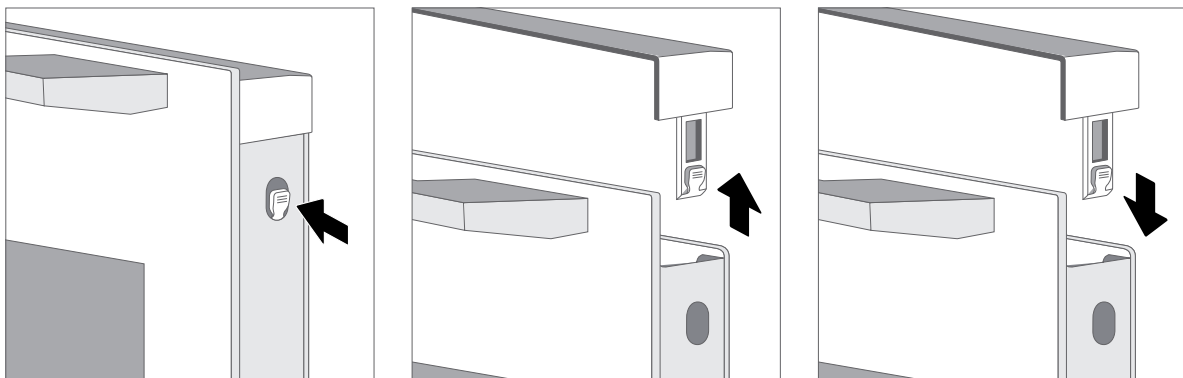

6) REMOVING THE OVEN RAILS

The rails inside the cooking chamber can be removed as per image for cleaning.

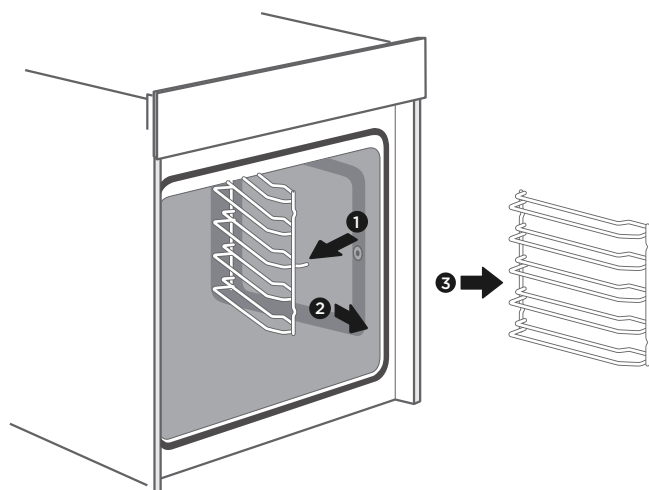

7) REMOVING THE OVEN TELESCOPIC RUNNERS

(Take the left side for example) Lift up one end of the telescopic runner. Then lift up the whole telescopic runner.

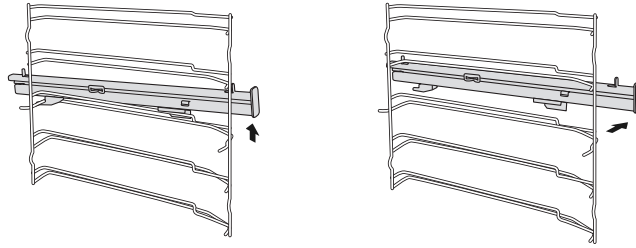

Attach the telescopic runner (left rail as example)

First put the point A and B of the telescopic runners horizontally on the outer wire. Rotate the telescopic runners anti-clockwise (clockwise for right rail) by 90degrees. Push forward the telescopic runners, make the point C buckled onto the lower wire and point D buckled onto the upper wire.

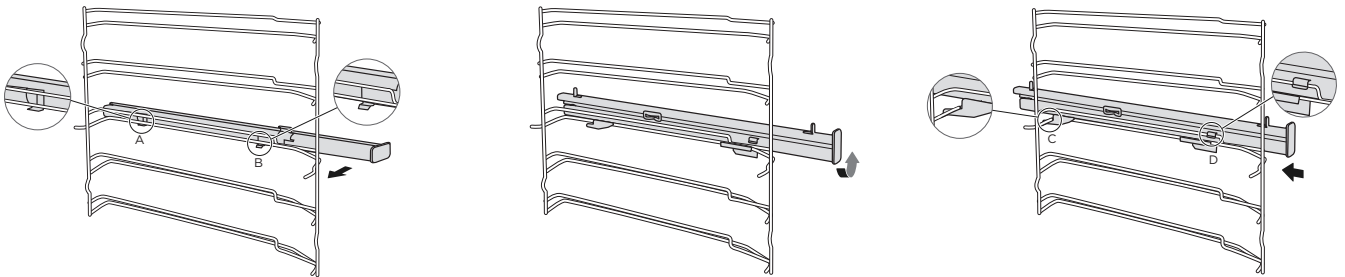

WARNINGS!

1. ACCESSIBLE PARTS MAY BECOME HOT DURING USE. YOUNG CHILDREN SHOULD BE KEPT AWAY.
2. ALL FIXED WIRINGS SHOULD BE CORRECTLY DONE, WELL INSULATED AND PROTECTED OR CONCEALED.
3. NEVER LINE THE OVEN ENAMEL WITH ALUMINIUM FOIL AS THIS WILL LEAD TO EXCESSIVE HEAT ACCUMULATION AND LEAD TO DAMAGE TO THE OVEN ENAMEL.
4. THE BOTTOM OF THE OVEN DOOR SHOULD BE HIGHER THAN 85MM FROM THE FLOOR.
5. AN ISOLATION SWITCH COMPLETE WITH A 15A PLUG SOCKET MUST BE INCORPORATED IN THE FIXED WIRING. THIS IS TO ENSURE THE APPLIANCE CAN BE SAFELY SWITCHED OFF AND DISCONNECTED FOR SERVICE.
6. WHEN IT IS IN USE THE APPLIANCE BECOMES HOT. CARE SHOULD BE TAKEN TO AVOID TOUCHING THE HEATING ELEMENTS INSIDE THE OVEN.
7. THE CONTROL PANEL IS DESIGNED TO BE CONNECTED TO SPECIFIC HEATING ELEMENTS ONLY. FITTING THE APPLIANCE WITH OTHER THAN ORIGINAL DILUSSO SPARES PART OR CARRYING OUT MODIFICATIONS MAY POSE POSSIBLE HAZZARDS
8. THE APPLIANCE IS NOT INTENDED FOR USE BY PERSON (INCLUDING CHILDREN) WITH REDUCED CAPABILITIES OR LACK OF EXPERIENCE AND KNOWLEDGE, UNLESS UNDER SUPERVISION BY A PERSON RESPONSIBLE FOR THEIR SAFETY.
9. ALWAYS MAKE SURE THE OVEN CONTROL KNOBS ARE IN Always make sure the knobs are in the "0" POSITION WHEN THE APPLIANCE IS NOT IN USE.

NOTE : To protect the surrounding furniture cabinets, after cooking is completed, the cooling fan may stay on until the oven has cooled down sufficiently.

Troubleshooting

If a fault occurs, before calling the after-sales service, please ensure that is not because of incorrect operations and refer to the below table.

| Fault | Possible Causes | Solution |
|--|--|---|
| The appliance does not work | Faulty fuse. | Check the circuit breaker in the fuse box. |
| | Power cut. | Check whether the kitchen light or other kitchen appliances are working. |
| Knobs have fallen out of the shaft in the control panel | Knobs have been accidentally disengaged. | Knobs can be removed. Simply place the knobs back in their shaft in the control panel and push them in so that they engage and can be turned as usual. |
| Knobs can no longer turned easily. | There is dirt under knobs. | Knobs can be removed. To disengaged knobs, simply remove them from the knob shaft. Alternatively, press on the outer edge of the knobs so that they tip and can be picked up easily. Carefully clean the knobs using a cloth and soapy water. Dry with soft cloth. Do not use any sharp or abrasive materials. Do not soak or clean in a dishwasher. Do not remove knobs too often to keep the shaft stable. |
| Fan does not work all the time in the "Fan Assist" mode. | This is normal, due to the best possible heat distribution and best possible performance in the oven. | |
| After cooking, a noise can be heard and air flow can be observed near the control panel. | The cooling fan is still working to prevent high moisture conditions in the cavity and to cool down the oven. The cooling fan will switch off automatically. | |
| The food is not sufficiently cooked in the time given by the recipe. | A temperature difference from the recipe is used. Double check the temperatures. The ingredient quantities are different to the recipe. Double check the recipe. | |
| Uneven browning. | The temperature setting is too high, or the shelf level could be optimised. Double check the recipe and settings. The surface finish and/or colour and/or material of the baking ware can also affect heat distribution. | |
| The light does not turn on | The light bulb needs to be replaced. | |

Warning! Risk of electric shock!

Incorrect repairs are dangerous. Repairs should always be carried out by a qualified service agent.

Maximum operating time

The maximum operating time of this appliance is 9 hours.

Replacing the oven light

If the cavity light fails, it must be replaced.

Heat resistant, 25W, 230Vac halogen lights are available from the after sales service agents. When handling the halogen light, use a dry cloth so that it will increase the service life of the light.

Once the oven has been electrically disconnected, unscrew the glass cover and pull out the halogen bulb.

Replace it with another one suitable for high temperatures of up to 300°C.

When inserting the new light bulb, making sure that the pins are in the correct position. Push the bulb in firmly.

Reassemble the glass cover and reconnect the oven.

