



Built-In Ceramic Hob

CC302GC

Installation and Operating Manual

CONTENTS:

Part 1: Safety warnings	Installation	3
	Operation & Maintenance	4
Part 2: Installation	Installation Instructions	7
Part 3: Operating Instructions	Product Overview	12
	Using your Hob	14
	Child Lock	15
	Pause Function	16
	Using the Timer	16
	Warning Indicators and Safety Mechanisms	18
Part 4: Cleaning and Maintenance	Cooking Guidelines	19
	Cleaning and Maintenance	21
	Troubleshooting	22

User: This manual contains advice, descriptions of functions and correct procedures for cleaning and maintaining the appliance.

Installer: This manual is for qualified technicians to correctly install the appliance and test its' operations. Please leave the manual for the User.

Congratulations on the purchase of your new hob and thank you for choosing our product.

Please read all the safety instructions carefully before use and keep this Manual for future reference.

Part 1. Safety Warnings

Your safety is important to us. Please read below information carefully before installing or using your Hob.

Installation

Electrical Shock Hazard

- Disconnect the appliance from the mains electricity supply before carrying out any work or maintenance on it.
- It is essential and mandatory that the appliance wiring system is earthed.
- Alterations to the wiring system must only be made by a qualified electrician.
- Failure to follow this advice may result in electrical shock and lead to serious consequences.

Cut Hazard

- Take care - panel edges are sharp.
- Failure to use caution could result in injury or cuts.

Important safety instructions

- Read these instructions carefully before installing or using this appliance.
- No combustible material or products should be placed on this appliance at any time.
- Please make this manual available to the person responsible for installing the hob, to avoid any potential hazards to the installer, the user and also damage to the appliance or home electrical system.
- In order to avoid a hazard, this appliance must be installed according to these instructions for installation.

- This appliance is to be properly installed and earthed only by a suitably qualified person.
- This appliance should be connected to a circuit which incorporates an isolating switch providing full disconnection from the power supply.
- Failure to install the appliance correctly could invalidate any warranty or liability claims.

Operation and Maintenance

Electrical Shock Hazard

- Do not use if the glass surface is broken or cracked. If the hob surface should break or crack, switch off the electrical power supply (isolation switch) and contact the service centre.
- Switch off the electrical power supply (isolation switch) before cleaning or maintenance.
- Failure to follow this advice may result in electrical shock or serious consequences.

Health Hazard

- This appliance complies with electromagnetic safety standards.
- However, persons with cardiac pacemakers or other electrical implants (such as insulin pumps) must consult with their doctor or implant manufacturer before using this appliance to make sure that their implants will not be affected by the electromagnetic field.
- Failure to follow this advice may result in serious consequences.

Hot Surface Hazard

- During use, accessible parts of this appliance will become hot enough to cause burns.
- Do not let your body, clothing or any item other than suitable cookware contact the glass surface until it is cool.
- Metallic objects such as knives, forks, spoons and lids should not be placed on the hob surface as they can get hot.
- Keep children away.

- Handles of saucepans may be hot to touch. Check saucepan handles do not overhang other cooking zones. Keep handles out of reach of children.
- Failure to follow this advice could result in burns and scalds.

Important safety instructions

- Never leave the appliance unattended when in use. Boil over causes smoking and greasy spillovers that may ignite.
- Never use your appliance as a work or storage surface.
- Never leave any objects or utensils on the appliance.
- Do not place or leave any magnetisable objects (e.g. credit cards, memory cards) or electronic devices (e.g. computers, MP3 players) near the appliance, as they may be affected by its electromagnetic field.
- Never use your appliance for warming or heating the room.
- After use, always turn off the cooking zones and the hob as described in this manual. Do not rely on the pan detection feature to turn off the cooking zones when you remove the pans.
- Do not allow children to play with the appliance or sit, stand, or climb on it.
- Do not store items of interest to children in cabinets above the hob. Children climbing on the hob could be seriously injured.
- Do not leave children alone or unattended in the area where the appliance is in use.
- Children or persons with a disability which limits their ability to use the appliance should have a responsible and competent person to instruct them in its use. The instructor should be satisfied that they can use the appliance without danger to themselves or their surroundings.
- Do not repair or replace any part of the appliance unless specifically recommended in the manual. All other servicing should be done by a qualified technician.
- Do not use a steam cleaner to clean the hob.
- Do not place or drop heavy objects on the hob.
- Do not stand on your hob.
- Do not use pans with jagged edges or drag pans across the glass surface as this can scratch the glass.
- Do not use scourers or any other harsh abrasive cleaning agents to clean your

hob, as these can scratch the ceramic glass.

- If the power supply cable is damaged, it must only be replaced by qualified technician.
- This appliance is intended to be used in domestic or similar applications such as:
 - staff kitchen areas in non-commercial kitchens; farm houses; by clients in hotels, motels and other residential type environments; bed and breakfast type environments.
- This appliance can be used by children aged from 8 years and above and by persons with reduced physical, sensory or mental capabilities or lack of experience and knowledge if they have been given supervision or instructions concerning use of the appliance in a safe way and understand the hazards involved. Children should not play with the appliance. Cleaning and user maintenance should not be made by children without supervision.
- This appliance is not intended to be operated by means of an external timer or separate remote control system.
- **WARNING:** Unattended cooking with fat or oil can be dangerous and may result in fire. NEVER try to extinguish a fire with water, but switch off the appliance and then cover flame with a lid or a fire blanket.
- **WARNING:** Do not store items on the cooking surface as this can become a fire hazard.
- **WARNING:** If the glass surface is cracked or any part of the electrical insulation is torn or damaged, immediately switch off the appliance to avoid possible electric shock.

Part 2. Installation

Installation Instructions

The appliance must be installed and connected in accordance with current regulations.

After unpacking the appliance, ensure there is no visible damage. If it has been damaged during transit, DO NOT USE, contact authorised seller immediately.

Worktop cutout

- The worktop must be of heat resistant material
- Ensure there is a minimum of 50mm worktop space around the cutout.
- The work surface should be a minimum thickness of 30mm. As shown below (measure by unit: mm):
- Cut out the work surface according to the sizes shown in the diagram below.

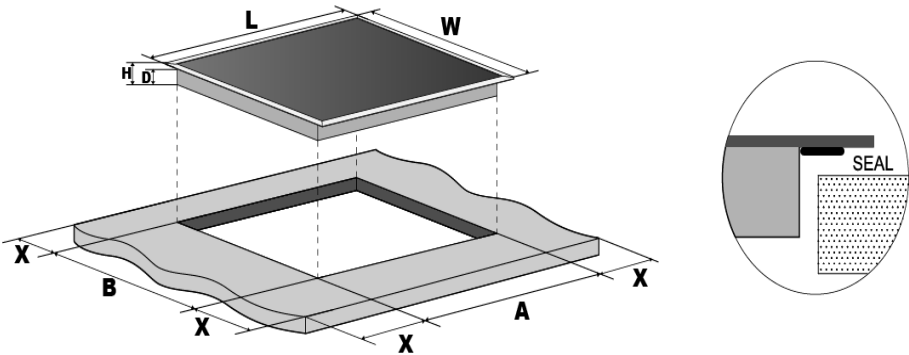

Dimensions in mm

Model	L	W	H	D	A	B	X
CC302GC	288	520	52	48	265+5 -0	495+5 -0	50 min

Under all circumstances, make sure the electric hob is well ventilated and the air inlet and outlet are not blocked. Ensure the electric hob is installed in a good working environment. Provide for adequate ventilation as shown in the diagram below.



Note: The safety distance between the hotplate and the cupboard above the hotplate should be at least 760mm.

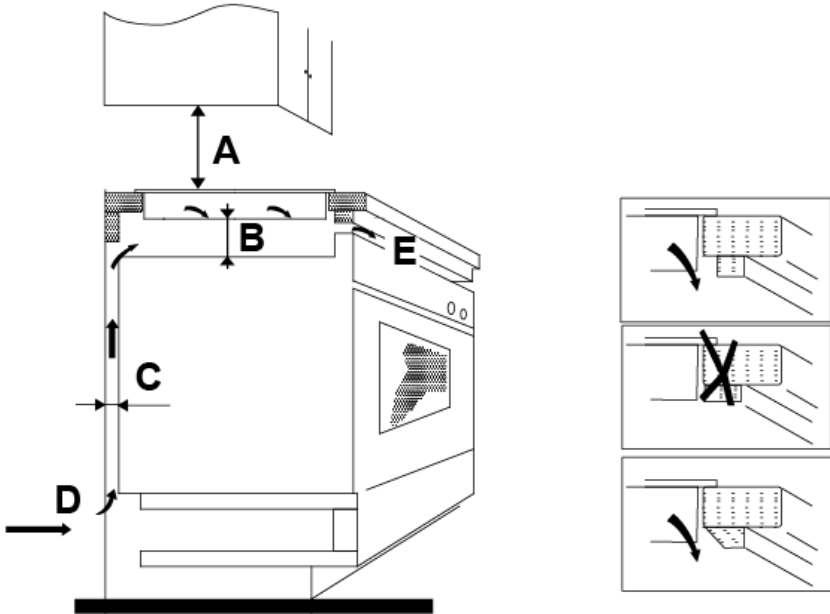

A(mm)	B(mm)	C(mm)	D	E
760mm	50mm min.	20mm min.	Air intake	Air outlet 5mm



Ensure cabinetry, rear and adjacent walls are able to resist temperatures up to 150°C

Installing the foam gasket

Before inserting the hob into the cabinetry cutout, the supplied foam gasket (in a plastic bag) must be attached to the lower side of the ceramic glass.



Do not install the hob without the foam gasket!

The gasket is to be attached with the following method:

- Remove the protection film from the gasket.
- Then attach the gasket to the lower side of the glass, next to the edge.
- The gasket must be attached along the entire length of the glass edge and should not overlap at the corners.
- When attaching the gasket, make sure that the glass does not come into contact with any sharp objects.

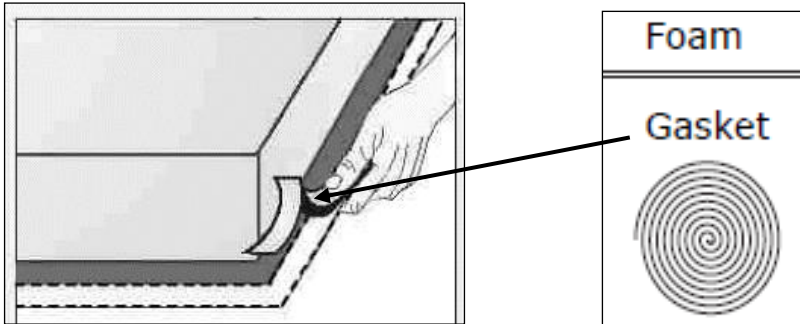

Installing the fixing brackets

The unit should be placed on a stable, smooth surface (use the packaging). Do not apply force onto the controls protruding from the hob.

Easy Fit kit

There is an easy fit kit included which includes fixing clips and screws (2pcs x clips and 2pcs x screws).

Fix clips to hob: Insert the fixing clips into fixing brackets located on both sides of the housing, fix clip to housing with screw, then insert hob into cabinet/work surface.

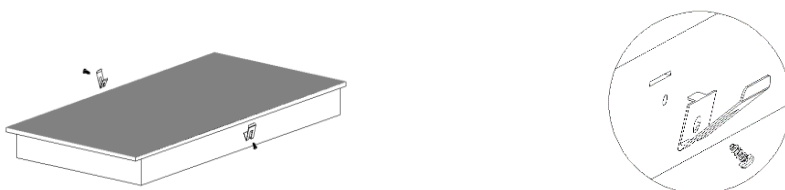

Fix hob to work surface: Insert the hob into the work surface as below diagrams, the fixing clips on the sides will secure your hob sturdily.

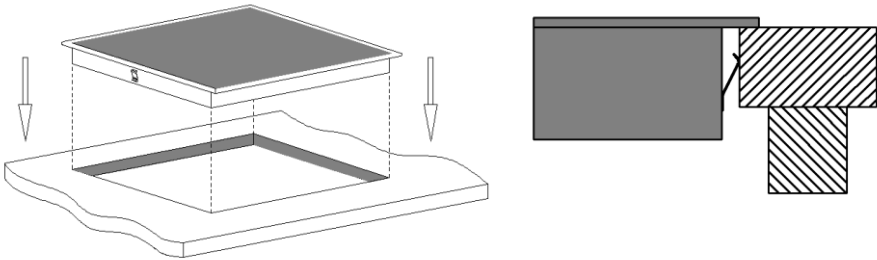

Connecting the hob to the mains power supply

The manufacturer will not be liable for any direct or indirect damaged caused by faulty installation. The installer must ensure the product installation and connections complies with local and general regulations in force.

The power supply should be connected in compliance with the current electrical rules and regulations. The appliance has a large power rating and must be connected by a Qualified Electrician.



This appliance must be earthed. An isolation circuit breaker switch with suitable amperage must be incorporated in the fixed wiring



Product Model	: CC302GC
Rated Voltage	: 240V~
Rated Frequency	: 50Hz
Max. Rated Input	: 3000W
Supply Connection	: 16A (double pole switched fused outlet with 3mm contact gap)

Notes:

1. If the cable is damaged or needs replacing, this should be done by an after-sales technician using the proper tools, so as to avoid any accidents.
2. If the appliance is being connected directly to the mains supply, an omni polar circuit breaker must be installed with a minimum gap of 3mm between the contacts.
3. The installer must ensure that the correct electrical connection has been made and that it complies with safety regulations.
4. The cable must not be bent or compressed.
5. The cable must be checked regularly and only replaced by qualified technician.

Cautions

1. **The hob must be installed by qualified personnel or technicians.** Please never conduct the operation by yourself.
2. The electric hob shall not be mounted to cooling equipment, dishwashers and rotary dryers.
3. The electric hob shall be installed whereby there is sufficient heat dissipation to ensure optimal performance and reliability.
4. The wall and induced heating zone above the work surface shall withstand heat.
5. To avoid any damage, any joinery/cabinetry in contact and adhesive used must be heat resistant.
6. A steam cleaner is not to be used.
7. This electric hob can be connected only to a supply with system impedance no more than 0.427 ohm. In case necessary, please consult your supply authority for system impedance information.

Part 3. Operating Instructions

Product Overview

Model: CC302GC

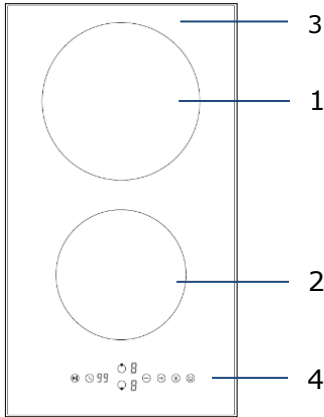

1. 1800W Cooking Zone
2. 1200W Cooking Zone
3. Glass plate
4. Control panel

Control Panel

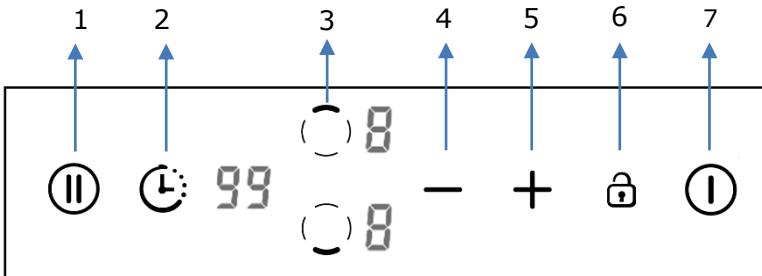

1. Pause button
2. Timer control button
3. Cooking Zone selection button
4. Heating level/Timer decrement button
5. Heating level/Timer increment button
6. Child Lock control button
7. ON/OFF button

Notes: Product diagrams in the manual for reference only, there might be slightly difference due to continually product improvements.

Before using your new Hob

- Read this guide, taking special note of the 'Safety Warnings' section.
- Remove any protective film that may still be on your new electric hob.

Using the Touch Controls

- The controls respond to touch, so you don't need to apply any pressure.
- Use the ball of your finger, not the tip.
- You will hear a beep each time a touch is registered.
- Make sure the controls are always clean, dry, and that there is no objects (e.g. a utensil or a cloth) covering them. Even a thin film of water may make the controls difficult to operate.

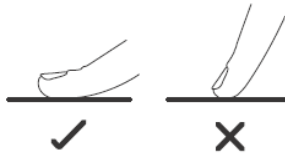

Choose the Right Cookware

Do not use cookware with jagged edges or a curved base.



Make sure that the base of your pan is smooth, sits flat against the glass, and is the same size as the cooking zone. If you use smaller pot efficiency could be less than expected. Always centre your pan on the cooking zone.

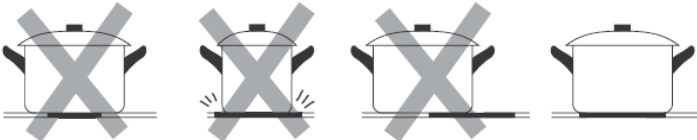

Always lift pans off the hob – do not slide, or it may scratch the glass.

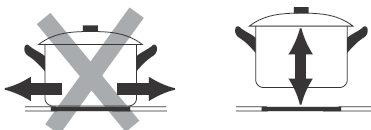

Using your Hob

To start cooking

1. After the hob be connected to the power supply.

Press and hold the ON/OFF  control button for about 3 seconds till you hear a "beep" to turn the hob on. Now the hob enters into Standby mode, all heat setting indicators and Timer setting indicators shows "-"



2. Place a suitable pan on the cooking zone you wish to use.

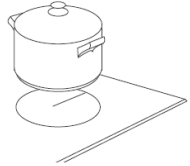

- Make sure the bottom of the pan and the surface of the cooking zone are clean and dry.



3. Select the cooking zone you wish to use.



-Touch control models:

- Adjust heat setting by touching the  or  button.
- Press and hold either of the adjustment buttons to adjust the setting rapidly.

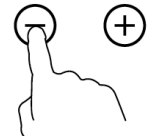



Notes:

1. When first connected to the power supply and turned power on, the hob will beep once, all indicators will light up for 1 second then go out.
2. When the hob is in Standby mode, and not used for 1 minute, the electric hob will automatically turn off, with the buzzer beeping once.
3. To turn on hob, press the ON/OFF control button and hold on for about 3 seconds; To turn it off, press ON/OFF button again.
4. The heating level can be adjusted from 0 to 9, default setting is level 5.
5. The indicator for the selected zone will flash when the temperature is being adjusted. After adjusting, the flashing will continue for 5 seconds then stop, the setting is confirmed.

To turn off the Hob

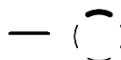
1. You can turn the cooking zone off by selecting the zone (if you are using more than one zone at a time) then adjust the heat setting to level 0 indicated by “-” sign



2. You can also turn the whole hob off by selecting the ON/OFF  control button.



Note: If there is a power outage during cooking, all settings will be cancelled.

Note: The cooling fan of induction hob will remain on for about 1 minute after the hob is turned off.

Child Lock Safety Control

- You can lock the controls to prevent unintended use (for example children accidentally turning the cooking zones on) by activating the Child Lock function.
- When the controls are locked, all touch control buttons are disabled except for the ON/OFF control button and Child Lock control button.

To lock the controls

Touch the Child Lock control button  once . The timer indicator will show “Lo”, and the Child Lock function is active.

To unlock the controls

1. Make sure the electric hob is turned on.
2. Touch and hold the Child Lock control button  for 3 seconds, the buzzer beeps once and “Lo” disappears from the timer indicator, the Child Lock is deactivated
3. You can now start using your electric hob.



Under the child lock mode, all controls button be disable except the ON/OFF button  and child lock  button.

You can always turn the hob off with the ON/OFF  control in an emergency, but you will need to unlock the hob first for further operation.

Note: Under Child Lock function, if the hob is turned off without deactivating the Child Lock function, the Child Lock function will still be active when the hob is turned back on.

Pause function

- This function can be used when you are being interrupted whilst cooking or you need to leave the cooking area temporarily.
- The **Pause function** can turn off all zones. With one more touch of the button  , the hob restarts with the previous settings to carry on cooking.

1. Activate Pause function

To activate **Pause** function, you can press the **Pause** function button once. Then all programmed settings will be on hold, the hob will stop heating and all heat setting indicators will show "P".

2. Deactivate Pause function

To cancel **Pause** function, you can press the **Pause** function again. Then all programmed settings will return to what they were, indicator "P" disappears.



When **Pause** function is active, all control buttons are disabled except the ON/OFF and Pause button.

Note: The hob will automatically turn off, if Pause function is active for more than 10 minutes.

Using the Timer

When the hob is turned on, you can use the timer in two different ways:

- You can use it as a minute minder. In this case, the timer will not turn any cooking zone off when the set time is up.
- You can set it to turn either one or more cooking zones off.

Note : The minute minder/timer can be set for up to 99 minutes.

Timer overview

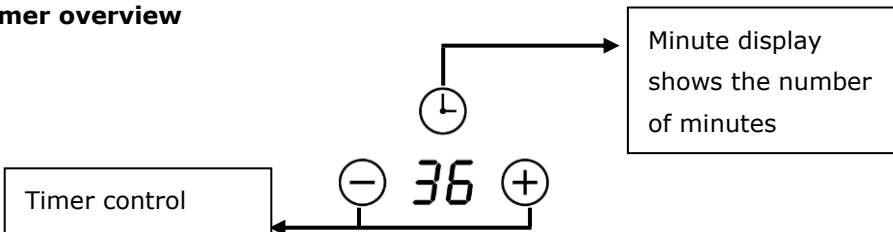



Using the Timer as a Minute Minder

If you have not selected any cooking zones

1. Touch the timer control button  , the number in timer indicator flashes.
2. Adjust the minute minder setting as follow:



Touch control models:

- Set heat setting by touching the  or  button.
- Press and hold either of the adjustment buttons to adjust the setting rapidly.

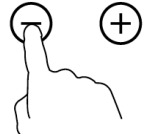

Note: When the timer indicator is flashing, touch timer control button one more time, to quickly confirm the timer setting.

3. When the minute minder is set, it will begin to count down immediately, the display will show the remaining time.
4. Buzzer will beep for 30 seconds and timer indicator shows "--" when the setting time finished. Any efficient touching of control buttons during it, would end up the buzzer beeps.

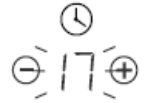



Setting the timer to turn cooking zone off

1. Select the cooking zone you wish to set timer for.
2. Touch the timer control button , a number in the timer indicator will flash.
3. Adjust Timer setting



Touch control models:

- Set timer setting by touching the  or  button.
- Press and hold either of the adjustment buttons to adjust the setting rapidly.

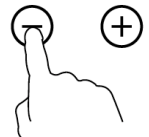

Note: When the timer indicator is flashing, touch timer control button one more time, to quickly confirm the timer setting.

4. When the timer is set, it will begin to count down immediately, the display will show the remaining time.

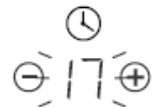

Note: The red dot next to zone indicator will illuminate for those zones set with a timer. You can check the timer settings of different cooking zones, by activating the cooking zone.

NOTE: If more than one heating zone has a timer setting, the timer indicator will show the shortest set time. The red dot next to the applicable zone indicator will flash.

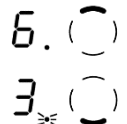

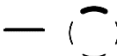
5. When cooking timer elapses, the corresponding cooking zone  will switch off automatically.

Note: The default setting of the minute reminder and timer is 30 minutes.

Note: After adjusting, the timer indicator will flashing for 5 seconds and when flashing is stop, the setting is registered.

Note: The minute reminder and timer can be used at the same time, timer indicator shows the lowest time setting. If the lowest setting is minute minder, the red dot next to timer indicator will flash. If the lowest setting is timer setting, the red dot of the corresponding cooking zone power level indicator will flash.

Note: If indicator shows timer setting, to check the minute minder setting, press the timer control button , the indicator will show minute minder setting.

Warning Indicators & Safety Mechanisms

Residual Heat Warning

Beware of hot surfaces

When the hob has been operating for a period of time, there will be some residual heat. The letter " H "appears in power setting indicator to warn you to keep away from it.

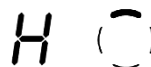

Auto Shutdown

Another safety feature of the hob is auto shutdown. This occurs whenever you forget to switch off a cooking zone. The default shutdown times as below table:

Power level	1	2	3	4	5	6	7	8	9
Default working timer (hour)	8	8	8	4	4	4	2	2	2

Over-heat Protection

A temperature sensor monitors the temperature inside the hob. When excessive temperature is registered, the hob will auto stop operations.

Over-flow Protection

For your safety, the hob will auto shutdown if liquid boils over or a wet cloth touches the control panel. All control buttons became deactivated except ON/OFF and Child Lock button until you wipe the touch control area dry.

Cooking Guidelines

Take care when frying as the oil and fat heat up quickly. At extremely high temperatures oil and fat can ignite spontaneously and present a risk of fire.

Cooking Tips

- When food comes to the boil, reduce the power setting.
- Using a lid will reduce cooking times and save energy by retaining the heat.
- Minimize the amount of liquid or fat to reduce cooking times.
- Start cooking on a high setting and reduce the setting when the food has heated through.

Simmering

- Simmering occurs below boiling point, at around 85°C, when bubbles are just rising occasionally to the surface of the cooking liquid. It is the key to delicious soups and tender stews because flavors develop without overcooking the food. You should also cook egg-based and flour thickened sauces below boiling point.

Searing steak

To cook juicy flavorsome steaks:

1. Stand the meat at room temperature for about 20 minutes before cooking.
2. Heat up a heavy-based frying pan.
3. Brush both sides of the steak with oil. Drizzle a small amount of oil into the hot pan and then lower the meat onto the hot pan.
4. Turn the steak only once during cooking. The exact cooking time will depend on the thickness of the steak and how cooked you want it. Times may vary from about 2 – 8 minutes per side. Press the steak to gauge how cooked it is – the firmer it feels the more 'well done' it will be.
5. Leave the steak to rest on a warm plate for a few minutes to allow it to relax and become tender before serving.

For stir-frying

1. Choose a induction compatible flat-based wok or a large frying pan.
2. Have all the ingredients and equipment ready. Stir-frying should be quick. If cooking large quantities, cook the food in several smaller batches.
3. Preheat the pan briefly and add two tablespoons of oil.
4. Cook any meat first, put it aside and keep warm.
5. Stir-fry the vegetables. When they are hot but still crisp, turn the cooking zone to a lower setting, return the meat to the pan and add your sauce.
6. Stir the ingredients gently to make sure they are heated through.
7. Serve immediately.

Heat Settings

The settings below are guidelines only. The exact setting will depend on factors including your cookware and the amount you are cooking. Experiment with the hob to find the settings that best suit you.

Heat setting	Suitability
1 - 2	<ul style="list-style-type: none">• delicate warming for small amounts of food• melting chocolate, butter, and foods that burn quickly• gentle simmering• slow warming
3 - 4	<ul style="list-style-type: none">• reheating• rapid simmering• cooking rice
5 - 6	<ul style="list-style-type: none">• pancakes
7 - 8	<ul style="list-style-type: none">• sautéing• cooking pasta
9	<ul style="list-style-type: none">• stir-frying• searing• bringing soup to the boil• boiling water

Part 4. Cleaning and Maintenance

Cleaning and Maintenance

Important: Before any maintenance or cleaning work is carried out, **DISCONNECT** the appliance from power supply and ensure the appliance is completely cool.

Cleaning the Hob Surface

Clean spillages from the hob surface as soon as possible after use. Always ensure the surface is cool enough before cleaning.

Use a soft cloth or kitchen paper to clean the surface. If the spillage has dried on the surface, you may need to use a special vitro-ceramic glass cleaner, which is available for most of supermarkets.

Do not use other abrasive cleaners and/or wire wool ect., as it may scratch the ceramic glass surface of your hob.

Damage from Sugary Spills and Melted Plastic

Special care should be taken when removing hot substances to avoid permanent damage of the glass surface.

Sugary spillovers (such as jellies, fudge, candy, syrups) or melted plastics can cause pitting of the surface of your cooktop (not covered by the warranty) unless the spill is removed while still hot. Special care should be taken when removing hot substances.

Hints and Tips

What?	How?	Important!
Everyday soiling on glass (fingerprints, marks, stains left by food or non-sugary spillovers on the glass)	<ol style="list-style-type: none">1. Switch off the power supply.2. Apply a vitro-ceramic glass cleaner while the glass is still warm (but not hot!)3. Rinse and wipe dry with a clean cloth or paper towel.4. Switch on the power supply to the hob.	<ul style="list-style-type: none">• When the power supply of the hob is turned off, there may be no 'hot surface' indication but the cooking zone may still be hot! Take extreme care.• Heavy-duty scourers, some nylon scourers and harsh/abrasive cleaning agents may scratch the glass. Always read the label to check if your cleaner or scourer is suitable.• Never leave cleaning residue on the hob glass surface: the glass may become stained.

<p>Boil over, melts, and hot sugary spills on the glass</p>	<p>Remove these immediately with a scraper suitable for ceramic glass of hobs, but beware of hot cooking zone surfaces:</p> <ol style="list-style-type: none"> 1. Switch off the power supply. 2. Hold the utensil at a 30° angle and scrape the soiling or spill to a cool area of the hob. 3. Clean the soiling or spill up with a dish cloth or paper towel. 4. Follow steps 2 to 4 for 'Everyday soiling on glass' above. 	<ul style="list-style-type: none"> • Remove stains left by melts and sugary food or spillovers as soon as possible. If left to cool on the glass, they may be difficult to remove or even permanently damage the glass surface. • Cut hazard: when the safety cover is retracted, the blade in a scraper is razor-sharp. Use with extreme care and always store safely and out of reach of children.
<p>Spillovers on the touch controls</p>	<ol style="list-style-type: none"> 1. Switch off the power supply. 2. Soak up the spill 3. Wipe the touch control area with a clean damp sponge or cloth. 4. Wipe the area completely dry with a paper towel. 5. Switch on the power supply to the hob. 	<ul style="list-style-type: none"> • The hob may beep and turn itself off, and the touch controls may not function while there is liquid on them. Make sure you wipe the touch control area dry before turning the hob back on.

Troubleshooting

Before you contact the service centre, the below actions may resolve the issue:

1. There is no power to the appliance:

- Check whether there is a power failure in your area;
- Check whether the appliance be connected to power supply and mains switched on;
- Has the timer setting elapsed;
- Check whether it has reached the longest cooking time setting and has auto shut off;
- Check whether there is liquid touching the control panel and the overflow protection device has automatically shut down the hob.

2. The touch control panel buttons cannot be activated:

- Check if it's under "Child Lock", whereby a "Lo" shows in timer display;
- Check whether liquid/wet cloth is over the touch control panel and overflow protection has been activated. Wipe dry area;

3. After cooking there is "H" shows on display:

- This is normal. The hob is with Residual Heat Warning safety features. It will remain on until the surface is cool enough for touch.

4. After turn off, the fan of induction hob remains working for a while:

- This is normal, this is to help appliances completely cool down.

5. Some pans make crackling or clicking noises during use of induction hob:

- This is normal, it's the sound of induction coils during working, and with different composition of cookware, the clicking might be slightly different.

6. The glass is scratched:

- Check whether you used unsuitable cookware, like rough-edged cookware.
- Check whether unsuitable, abrasive scourer or cleaning products have been used.

7. The heating element of ceramic hob turns on and off alternately when working:

- This is normal and natural feature for ceramic hob. Programmer of ceramic hob, together with the thermostat or thermocouple in heating element, could control the hob work at set power level and avoid overheat by heating element work on/off alternately.
- If working at highest power level, heating element will continue turn on for a certain time then on/off alternately.
- If working at other lower power level, heating element will on/off alternately at certain frequency since beginning based on power setting of the cooking zone.

Important Note:



DISPOSAL: Do not dispose this product as unsorted municipal waste. Collection of such waste separately for special treatment is necessary.

This appliance is labeled in compliance with European directive 2002/96/EC for Waste Electrical and Electronic Equipment (WEEE). By ensuring that this appliance is disposed of correctly, you will help prevent any possible damage to the environment and to human health, which might otherwise be caused if it were disposed of in the wrong way.

The symbol on the product indicates that it may not be treated as normal household waste. It should be taken to a collection point for the recycling of electrical and electronic goods.

This appliance requires specialist waste disposal. For further information regarding the treatment, recovery and recycling of this product please contact your local council, your household waste disposal service, or the shop where you purchased it.

For more detailed information about treatment, recovery and recycling of this product, please contact your local city office, your household waste disposal service or the shop where you purchased the product.