

**GL** LED US LIGHTING

Signage Lighting Products Catalog 2023





## CONTENT

---

Custom Neon Sign.....	01
LED Module Light.....	03
LED Ladder Light .....	05
LED Pixels Light Sheet - Single Color .....	07
LED Pixels Light Sheet - RGBW 4 IN 1.....	09
120V Dimmable LED Strip Light .....	11
120V RGB LED Neon .....	13
LED 3D Neon Light .....	15
LED Side Bend Neon Light - Wint.....	17
Color Changing RGB Controller.....	19
LED Power Supplies 12V .....	23

# Custom Neon Sign

## What's included

Custom Neon Sign

LED NEON LIGHT



Transformer



Suspension Kit



Wall Mounting Kit

## Colors Options

### 4/6/8mm wide NEON

#### Acrylic Color Options



## Acrylic Shape Options



A whole square board

A whole board with round corner

Cutting along the shape

Cutting along the letter

## Customizable Different Fonts

Font Name	Font Effect & Backing Shape		
Bayshore	<i>Bayshore</i>	<i>Bayshore</i>	<i>Bayshore</i>
Hesterica	<i>Hesterica</i>	<i>Hesterica</i>	<i>Hesterica</i>
Gruenewald	<i>Gruenewald</i>	<i>Gruenewald</i>	<i>Gruenewald</i>
Southampton	<i>Southampton</i>	<i>Southampton</i>	<i>Southampton</i>
Rocket Clouds	<i>Rocket Clouds</i>	<i>Rocket Clouds</i>	<i>Rocket Clouds</i>
Strude	<i>Stoner</i>	<i>Stoner</i>	<i>Stoner</i>
Quinzey	<i>Quinzey</i>	<i>Quinzey</i>	<i>Quinzey</i>
Neoneon	NEONEON	NEONEON	NEONEON
Kabel	KABEL	KABEL	KABEL
TimeBurner	TimeBurner	TimeBurner	TimeBurner
Northwell	<i>Northwell</i>	<i>Northwell</i>	<i>Northwell</i>
Shutter Stone	<i>Shutter Stone</i>	<i>Shutter Stone</i>	<i>Shutter Stone</i>
Linoleo Script	<i>Linoleo Script</i>	<i>Linoleo Script</i>	<i>Linoleo Script</i>
Nickainley	<i>Nickainley</i>	<i>Nickainley</i>	<i>Nickainley</i>
Brittany Signature	<i>Brittany Signature</i>	<i>Brittany Signature</i>	<i>Brittany Signature</i>
Ottawa	<i>Ottawa</i>	<i>Ottawa</i>	<i>Ottawa</i>
Shutter Stone	<i>Shutter Stone</i>	<i>Shutter Stone</i>	<i>Shutter Stone</i>
Ostrich Sans	OSTRICH SANS	OSTRICH SANS	OSTRICH SANS
Poiret One	Poiret One	Poiret One	Poiret One
Novecento wide	NOVECENTO	NOVECENTO	NOVECENTO



# LED Module Light

LED modules have excellent transmissivity and uniformity, making module lights perfect to illuminate low profile channel letters.

# Ming X



## LED Single Color Module Light



Input Voltage: 12VDC  
Wire Size: 18 AWG, 2 wires

Dimensions: 2.7" x 0.6" x 0.4"  
Length: 2 modules/ft



Model	Watts/Module	Color Temperature	Lens	Viewing Angle	Qty/Bag
Z3V-05-O3-a7-072-S2	0.72	3000K	Clear	140°	200
Z3V-05-W6-a7-120-S2	1.2	6500K	Frosted	170°	200
Z3V-05-W9-a4-120-S2	1.2	9000K	Clear	140°	200
Z3V-05-W9-a7-120-S2	1.2	9000K	Frosted	170°	200
Z3V-05-R-a7-072-K2	0.72	Red	Clear	140°	200
Z3V-05-G-a7-072-K2	0.72	Green	Clear	140°	200
Z3V-05-B-a4-072-K2	0.72	Blue	Clear	140°	200
Z3V-05-Y-a4-072-K2	0.72	Yellow	Clear	140°	200
Z3V-05-T-a7-072-K2	0.72	Turquoise	Clear	170°	200
Z3V-05-P-a7-072-K2	0.72	Pink	Clear	170°	200



Input Voltage: 12VDC  
Wire Size: 18 AWG, 2 wires

Dimensions: 0.47" x 0.31" x 0.19"  
Length: 8 modules/ft



Model	Watts/Module	Color Temperature	Lens	Viewing Angle	Lumen/Module	Qty/Bag
Z1U-V05-W(S)-a6-024-3	0.24W	6500K	Frosted	160°	25	200



Input Voltage: 12VDC  
Wire Size: 20 AWG, 2 wires

Dimensions: 1.69" x 1.69" x 0.27"  
Length: 2 modules/ft



Model	Watts/Module	Color Temperature	Lens	Viewing Angle	Lumen/Module	Qty/Bag
Z4U-V05-W-a4-144-1	1.44W	11000K	Clear	140°	117	100

## LED Color Changing RGB Module Light



Input Voltage: 12VDC  
Wire Size: 18 AWG, 4 wires  
Length: 2 modules/ft

Dimensions:  
Z3V-5F-F-a6-072-K5: 2.7" x 0.6" x 0.4"  
Z3V-5F-F-a6-144-K2: 1.69" x 1.69" x 0.27"



Model	Watts/Module	Color Temperature	LED	Lens	Viewing Angle	Qty/Bag
Z3V-5F-F-a6-072-K5	0.72W	RGB	3	Clear	160°	100
Z3V-5F-F-a6-144-K2	1.44W	RGB	4	Clear	160°	100



# LED Ladder Light

GL LED offers LED ladder lights with energy efficiency, affordability, and outstanding performances. Rows of strips with LED chips are stacked together to form a ladder-like light, and this product is a perfect backlighting solution for a wide range of applications, including sign boards, fabric displays, letter channels, and other general backlighting usages.

## Features

- Ladder design for easy installation
- Special secondary light dissipation lens for uniform illumination
- Adopted aluminum PCB for a better heat dissipation
- 160° lens for perfectly diffused light
- 3M double sided tape on the back of buckle position;
- 1ft (30cm) lead wires on top and bottom
- Available in 2 models: JYD2-C-4305-V2, covering 21”(W) x 50”(H); JYD2-C-9310-V2, covering 42”(W) x 50”(H)
- UL certified
- Limited 3 years warranty

## Application

The LED Ladder light is an excellent choice for backlighting. Its configured 160° lens ensures perfectly diffused light. With a depth of 2 inches away from an illuminated surface, no dark spots will be observed.

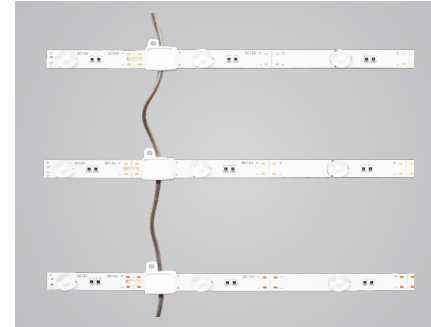

## Specification

Model	JYD2-C-4305-5-V2	JYD2-C-9310-10-V2
CCT	6500K	
Brightness	99.51 lm/W, 5550 lm	99.14 lm/W, 10338 lm
Power Consumption	4.8W/Row, 57.6W per unit	9.6W/Row, 115.2W per unit
Input Voltage	12VDC	12VDC
LED Per Unit	5 LEDs/Row, 12 rows	10 LEDs/Row, 12 rows
View Angle	160°	160°
CRI	80+	80+
Dimension	16 <sup>30</sup> / <sub>32</sub> ”(W) x 45”(H) x 1 <sup>1</sup> / <sub>32</sub> ”(D)	36 <sup>20</sup> / <sub>32</sub> ”(W) x 45”(H) x 1 <sup>1</sup> / <sub>32</sub> ”(D)
Location	Dry	
Dimmable	Yes	
Warranty	3 YEAR WARRANTY	



# LED Pixels Light Sheet - Single Color NEW

This LED pixels light sheet provides uniform illumination. It is great for backlighting applications where it can be easily bended to fit into thin and irregular surfaces and spaces. Pixel light sheet is very easy to cut (single color: cuttable by each individual LED chip) and the feature allows customers to design their own shapes of light with great flexibility.

## Features

- Flexible and cuttable design allows for easy installation and illuminates every edge with light
- Ideal for a backlight of showcases, billboards, translucent walls, and signage light boxes
- Easy installation with 300 LSE 3M tape backing
- A minimum distance of 1.18 in is recommended between the light sheet and a diffuser to achieve a spotless effect
- Able to achieve spotless effect when used for a 1.12" thick onyx at a 0" distance
- Each LED pixels light sheet contains 1 piece of power lead wire and 1 piece of jumper wire
- Limited 5 years warranty

1.18 inches deep with no dark spots.

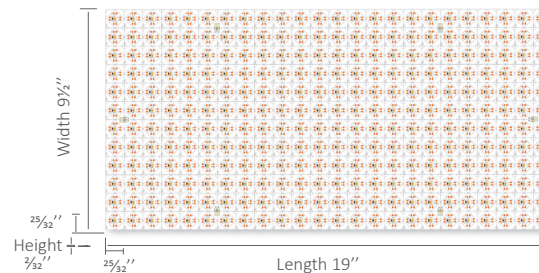

## Specifications

Input Voltage	LED Quantity	Cut Point	CRI	Location	Dimmable	Warranty
24VDC	288 LEDs/sheet	1 LED/cut	90+	Dry	Yes	5 years

Model	Color Temperature	Brightness	Power Consumption	Max Run Without Voltage Drop	Light Efficiency
GL-PLS-288-125-24V-10W-2700K	2700K	909 lm/sheet	10W/sheet	12 Sheets Max	91 lm/W
GL-PLS-288-125-24V-10W-3000K	3000K	960 lm/sheet	10W/sheet	12 Sheets Max	96 lm/W
GL-PLS-288-125-24V-10W-4000K	4000K	1010 lm/sheet	10W/sheet	12 Sheets Max	101 lm/W
GL-PLS-288-125-24V-10W-5000K	5000K	1010 lm/sheet	10W/sheet	12 Sheets Max	101 lm/W
GL-PLS-288-125-24V-30W-2700K	2700K	2646 lm/sheet	30W/sheet	4 Sheets Max	88 lm/W
GL-PLS-288-125-24V-30W-3000K	3000K	2793 lm/sheet	30W/sheet	4 Sheets Max	93 lm/W
GL-PLS-288-125-24V-30W-4000K	4000K	2940 lm/sheet	30W/sheet	4 Sheets Max	98 lm/W
GL-PLS-288-125-24V-30W-5000K	5000K	2940 lm/sheet	30W/sheet	4 Sheets Max	98 lm/W

## Accessories

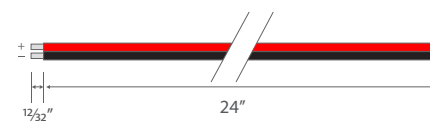

Power Lead Wire  
GL-PLS-PLW-S-24

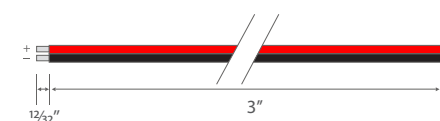

Jumper Wire  
GL-PLS-JW-S-3



# LED Pixels Light Sheet - RGBW 4 IN 1 NEW

This LED pixels RGBW light sheet is a fully customizable, flexible and color changing LED sheet with uniform illumination. It is great for backlighting applications where it can be easily bended to fit into thin and irregular surfaces and spaces. The pixels light sheet can be cut by 18 LED and the feature allows customers to design their own shapes of light with great flexibility. Multiple sheets can be easily linked together using onboard wago connectors or soldering connectors.

## Features

- Good for a backlight of showcases, billboards, translucent walls, and signage light boxes
- Linkable by onboard wago connectors or soldering connectors
- Easy installation with 300 LSE 3M tape backing
- Color-changing and dimmable with optional DMX controllers
- A minimum distance of 1.18 in is recommended between the light sheet and a diffuser to achieve a spotless effect
- Able to achieve a spotless effect when used as backlight for onyx surfaces with a distance of 0 in
- UL listed, 50,000h long lifespan with 5 years limited warranty
- Each LED pixels light sheet contains 1 piece of power lead wire and 1 piece of jumper wire
- Limited 5 years warranty

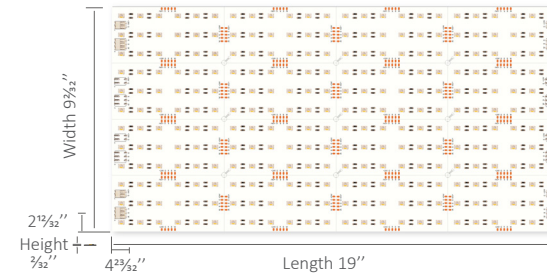

## Specifications

Input Voltage	LED Quantity	Cut Point	Location	Dimmable	Warranty
24VDC	288 LEDs/sheet	18 LEDs/cut	Dry	Yes	5 years

Model	Color Temperature	Brightness	Power Consumption	Max Run Without Voltage Drop
GL-PLS-288-125-24V-40W-RGBW-3000K	Red	440 lm/sheet	40W/sheet	6 Sheets
	Green	940 lm/sheet		
	Blue	184 lm/sheet		
	3000K	980 lm/sheet		
	RGB	1550 lm/sheet		
	RGBW	2506 lm/sheet		

## Accessories

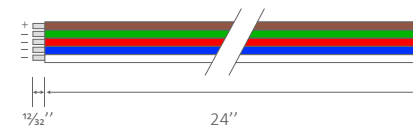

Power Lead Wire  
GL-PLS-PLW-RGBW-24

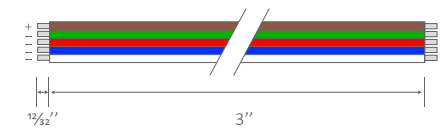

Jumper Wire  
GL-PLS-JW-RGBW-3





# 120V Dimmable LED Strip Light

## Features

- 120V AC operation (no additional power supply required)
- IP65- Suitable for wet locations
- ELV dimmer compatible
- Can span long run up to 50m/164ft
- High lumens output and high PF
- Viewing angle 120°
- Overvoltage protection
- Over temperature protection
- Customized lengths
- Minimum cutting distance: 4" for PRO-S; 12" for PRO-H
- Fast and easy installation to save labor costs
- ETL, FCC certified
- Limited 5 years warranty



# 120V Dimmable LED Strip Light

## Specifications

Operation Voltage	Location	Dimmable	Warranty
120VAC	Dry/Wet	Yes	5 years

	Model	CCT	Brightness	Power Consumption	Light Efficiency	LED Quantity	No Voltage Drop
PRO-S	GL-LV-2835WWC-96H-120-2700K	2700K	380 lm/ft	4.5W/ft	84 lm/W	24 LEDs/ft	100 ft Max
	GL-LV-2835WWC-96H-120-3000K	3000K	400 lm/ft	4.5W/ft	88 lm/W	24 LEDs/ft	100 ft Max
	GL-LV-2835WWC-96H-120-4000K	4000K	420 lm/ft	4.5W/ft	93 lm/W	24 LEDs/ft	100 ft Max
PRO-H	GL-LV-2835NWC-144H-120	4000K	320 lm/ft	4W/ft	80 lm/W	36 LEDs/ft	164 ft Max
	GL-LV-2835B-144F-120	Blue	60 lm/ft	4W/ft	15 lm/W	36 LEDs/ft	164 ft Max
	GL-LV-2835R-144F-120	Red	34 lm/ft	4W/ft	9 lm/W	36 LEDs/ft	164 ft Max

## Dimension

120V Dimmable LED Strip Light - PRO-S

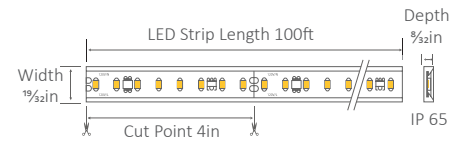

120V Dimmable LED Strip Light - PRO-H

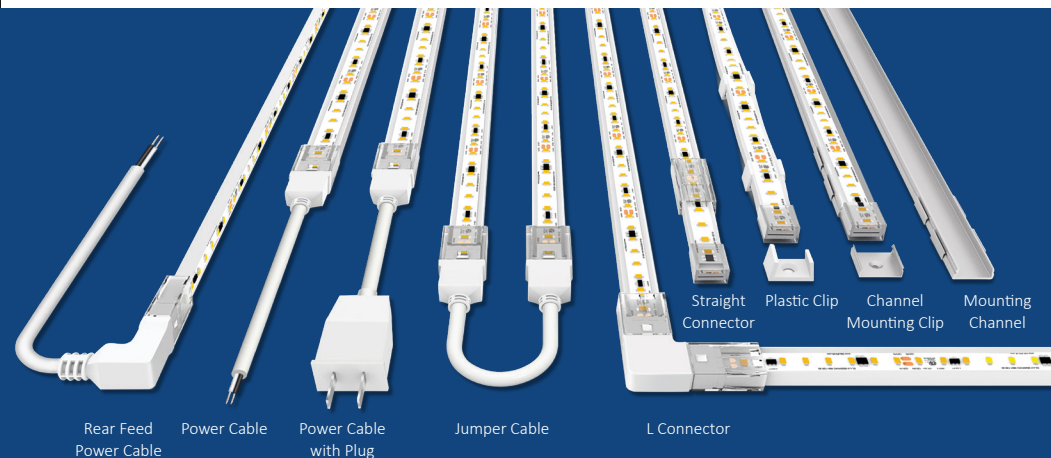
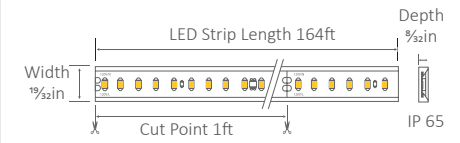

# 120V RGB LED Neon

120V RGB LED Neon light is a color changing driverless LED light that can run maximum to 150ft with a 120VAC power input. It can be used for both interior and exterior environments. This flexible RGB LED Neon light is suitable for building and structure outline, cove lighting, accent lighting, curve/round shape lighting, signage and art work.



## 120V RGB LED Neon



### Features

- 120V AC direct plug in or hardwire connection
- Color changing for different decoration requirements
- Flexible for any complex shapes
- Can span long run up to 150ft
- Suitable for wet location IP65
- Customized cut available
- Limited 3 years warranty



### Specifications

Model	Input	Power	Min. Section	One Run Maximum
GL-NE-59-RGB-120V-IP65	AC-120V	2.7W/ft	18inch	150ft

### Dimension

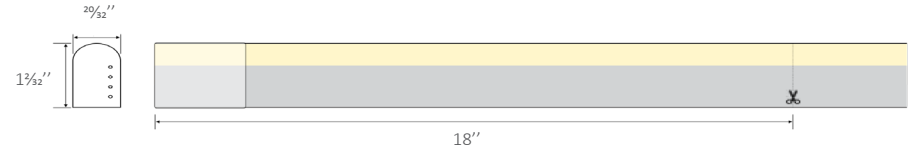

### Accessories



Mounting Clip  
GL-NE-59-RGB-120V-MCL



Mounting Channel  
GL-NE-59-RGB-120V-MCH



# LED 3D Neon Light

Compared with traditional neon lights, this product has an ultra-smooth linear light output, and it is safe and flexible to create all kinds of shapes with a low voltage power input. It is three sides illuminated and looks beautiful from every angle. Our proprietary rapid connectors can be used for customers to easily link and create beautiful neon lights without a soldering process.

This dimmable, dot free, and flexible 3D neon light is good for both residential and commercial applications in a dry or wet environment.

## Features

- Dot free, uniform, and smooth illumination with no hotspots
- Top bend, 3-dimensional light emitting
- Flexible with a 4.72 in (120mm) minimum bending diameter
- Suitable for wet and dry locations
- UL certified
- Limited 3 years warranty

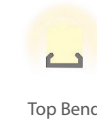
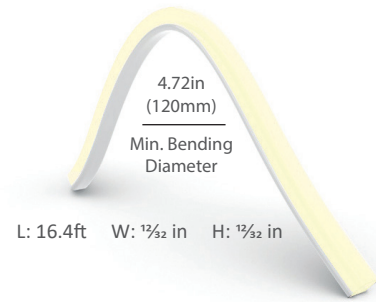

## Specifications

- Input Voltage: 24VDC
- Power Consumption: 4.4W/ft
- Cut Increment: 4in
- Wet location IP65
- Max Run Without Voltage Drop: 16.4 ft
- Limited 3 years warranty
- Dimming Method: PWM, Forward phase, Triac, 0-10V, MLV, ELV

Model	Color Temperature	Brightness	CRI
GL-3DN-2216-240-3000K-24V-IP65	3000K	414lm/ft	90+
GL-3DN-2216-240-6500K-24V-IP65	6500K	427lm/ft	90+
GL-3DN-2216-240-R-24V-IP65	Red	54.7lm/ft	N/A
GL-3DN-2216-240-B-24V-IP65	Blue	103.4lm/ft	N/A
GL-3DN-3535-120-RGB-24V-IP65	RGB	183.4lm/ft	N/A

## Dimension

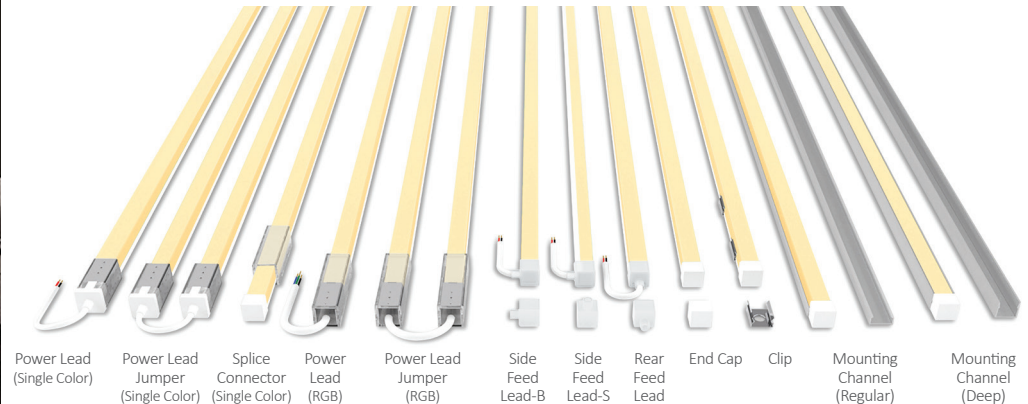
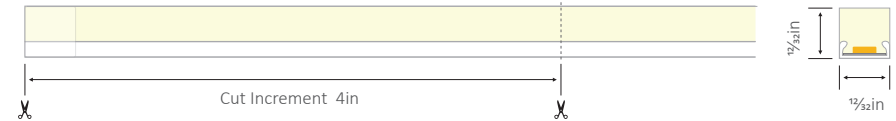



# LED Side Bend Neon Light - WINT

This LED WINT neon light is cuttable at any point (single color model), and super flexible to be bended with a dome profile. With a side bend design, it provides brilliant outlines from both front and side directions. The WINT neon light produces uniform, dot-free, smooth, and comfortable illumination, possesses strong impact and high weather resistances, and allows flexibility in installations with three different orientations of the lead wire end caps. This dimmable and flexible WINT neon light is good for both residential and commercial applications in a dry or wet environment.

## Features

- Dot free, uniform, and smooth illumination with no hotspot
- Side bend providing smooth outlines
- Single color model can be cut at any point
- Flexible with a 1.18 in (30mm) minimum bending diameter
- Suitable for both wet and dry locations
- UL certified
- Limited 5 years warranty



Min. Bending Diameter  
1.18in (30mm)



Side Bend



L: 16.4ft W: 1/2 in H: 1/2 in

## Specifications

- Input Voltage: 24VDC
- Power Consumption: 4.4W/ft
- Cut Increment: Single Color: Any point  
RGB: 3 1/2 in
- Wet location IP67
- Max Run Without Voltage Drop: 16.4 ft
- Limited 5 years warranty
- Dimming Method: PWM, Forward phase, Triac, 0-10V, MLV, ELV

Model	Color Temperature	Brightness
GL-WINT-2835CVAW-14-3000K	3000K (White Jacket)	115lm/ft
GL-WINT-2835CVAW-14-6500K	6500K (White Jacket)	127.6lm/ft
GL-WINT-2835CVAR-14	Red (Red Jacket)	24.2lm/ft
GL-WINT-2835CVAB-14	Blue (Blue Jacket)	3.5lm/ft
GL-WINT-2835CVAW-14(B)	Blue (White Jacket)	16.3lm/ft
GL-WINT-2835CVFM-14	RGB (White Jacket)	35.8lm/ft

## Dimension

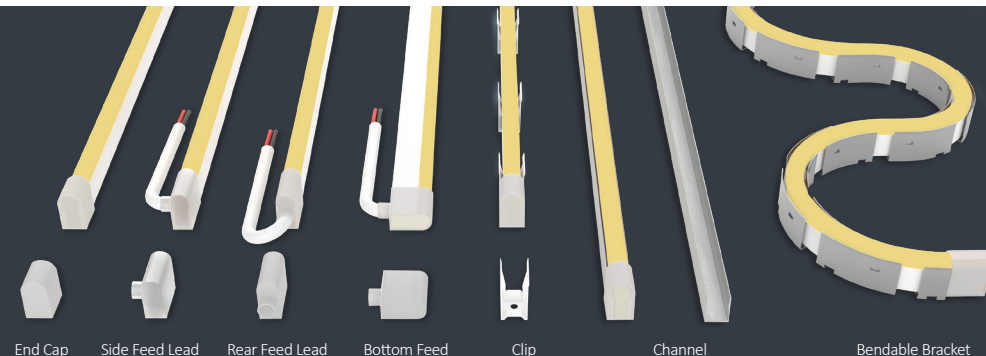
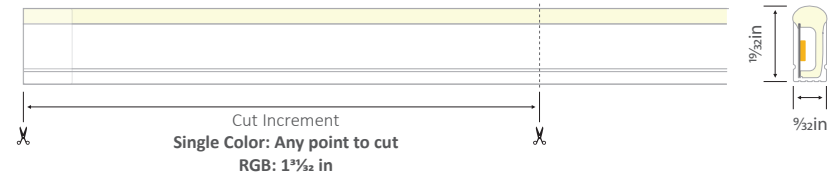

End Cap Side Feed Lead Rear Feed Lead Bottom Feed Clip Channel Bendable Bracket

# Color Changing RGB Controller

LED control system provides as much as you can imagine for any LED lighting output.

GL LED provides different kinds of LED controllers. LED Controllers and dimmers allow you to achieve the exact brightness, lighting effects and color levels desired from LED lighting. We offer a large selection of LED sensor switches, dimmers, color changing RGB controllers, DMX controllers, amplifiers, and more.

# Yong GL



## Wireless - ZIP Series



ZIP RGBW Remote Controller 4 Zones  
ZIP-RGB-RM-T-4Z-B



### Features

- Operating Voltage: AAA Battery
- Control method: RF Control
- Dry location IP20
- Certification: TUV, CE, FC, ROHS, UL
- Limited 5 years warranty

### Specifications

Mounting	Control Zones	Operation Voltage	Color
Portable	4 zone	AAA Battery	Black

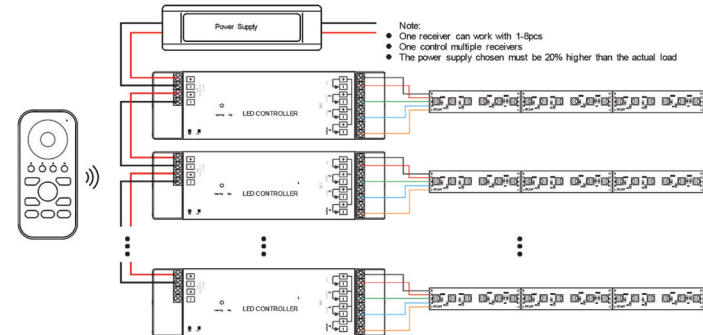

**Wired - DMX Series**



DMX controllers have a color-selection wheel for thousands of color options, 0-100% dimming, no flickering, on/off controls, and 4 color-specific channel controls for red, green, blue, and white. No flickering, Please note that the DMX Color Changing Controllers must be used with a DMX decoder in order to control LED lights.

**DMX RGBW Wall Mount Controller 1 Zone**

DMX-RGB-WM-T-1Z-W

**Features**

- Operating Voltage: 12V or 24V
- Control method: DMX
- Standard DMX512 Signal output
- Dry location IP20
- Certification: TUV, CE, FC, ROHS, UL
- Limited 5 years warranty

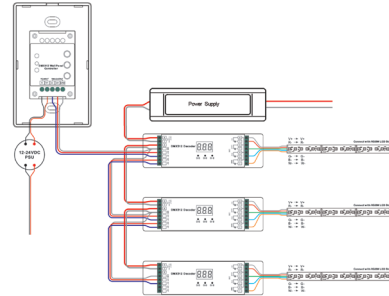

**Specifications**

Mounting	Control Zones	Operation Voltage	Color
Wall Mount	1 zone	12-24VDC	White

**DMX RGBW Wall Mount Controller 3 Zones**

DMX-RGB-WM-T-3Z-W

**Features**

- Operating Voltage: 12V or 24V
- Control method: DMX
- Standard DMX512 Signal output
- Dry location IP20
- Certification: TUV, CE, FC, ROHS, UL
- Limited 5 years warranty

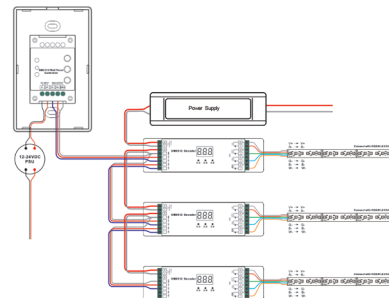

**Specifications**

Mounting	Control Zones	Operation Voltage	Color
Wall Mount	3 zones	12-24VDC	White

**Wired - Knob Series**



**Knob RGBW Controller**



**Features**

- Operating Voltage: 12V or 24V
- Control method: Hard wire
- Dry location IP20
- Certification: TUV, CE, FC, ROHS, UL, RU
- Limited 5 years warranty

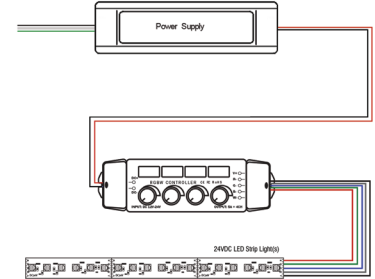

**Specifications**

Mounting	Control Zones	Operation Voltage	Max. Load	Color
Wall Mount	1 zone	12-24VDC	5A x 4CH	White

**Wired - SIM Series**

Modern and sleek design with flexibility and convenience



**SIM Wall Mount RGB Controller**

SIM-RGB-WM-T-1Z-W/B

**Features**

- Operating Voltage: 12V or 24V
- Control method: Hard Wire
- Dry location IP20
- Certification: CE
- Limited 2 years warranty

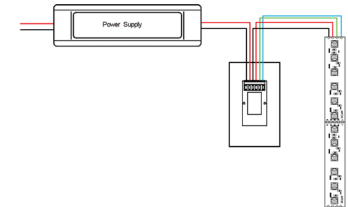

**Specifications**

Mounting	Control Zones	Operation Voltage	Max. Load	Color
Wall Mount	1 zone	12-24VDC	4A x 3CH	White, Black



# LED Power Supplies 12V

A power supply, also referred to as a driver or transformer, is responsible for providing adequate voltage output and power to illuminate LED lights. Our range of LED transformers includes options such as dimmable or non-dimmable, waterproof or non-waterproof, and plug-in or hard-wired connections, suitable for both residential and commercial applications.



## V SERIES

Low cost and small size



Junction Box



Power Cord  
(Black, White)

Compatible Junction Box & Power Cord are available

### Specifications

Model	Input Voltage	Output Voltage	Wattage	Rated Current	Location	Warranty
APV-8W-12V	90-264VAC	12VDC	8W	0.67A	Dry	2 Years
APV-35W-12V	90-264VAC		35W	3A		
FP-60W-12V	90-277VAC		60W	5A	Wet	

## H SERIES

High efficiency and reliability



Junction Box



Power Cord  
(Black, White)

Compatible Junction Box & Power Cord are available

### Specifications

Model	Input Voltage	Output Voltage	Wattage	Rated Current	Location	Warranty
XLG-100W-12V	100-305VAC	12VDC	100W	8A	Wet	5 Years
XLG-150W-12V			150W	12.5A		

## Y SERIES

Simple plug in



### Specifications

Model	Input Voltage	Output Voltage	Wattage	Rated Current	Location	Warranty
DVE-12W-12V	100-240VAC	12VDC	12W	1A	Dry	2 Years
TPS-36W-12V			36W	3A		
TPZ-60W-12V			60W	5A		
TPZ-96W-12V			96W	7A		



[WWW.GLLEDUS.COM](http://WWW.GLLEDUS.COM)

501 W 18TH ST, CHICAGO, IL 60616

312.600.9363

[admin@gllledus.com](mailto:admin@gllledus.com)

