

# LED Track Light - STANDARD 22W-4000K



## Product Description

LED track light is specially designed for task and accent lighting. Provide a variety of easily interchangeable lenses. High quality lighting with efficient brightness. Low UGR.

Compatible Track system: Halo

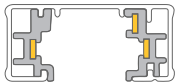

## Features

- Interchangeable Beam: 15°, 24°, 40°, 60°
- CAMETA anti-glare design and with shielding angle to reduce wide beam angle glare lights
- Integral driver, isolated circuit
- 350° rotation (horizontal), 90° adjustable (vertical)
- Self-cleaning thanks to the cylinder shape
- Lifespan (hrs): 50,000hr
- 5 year warranty
- Passive cooling achieved by innovative thermal design.

## Specification

<b>Input Voltage</b>	120VAC, 50/60Hz
<b>Power</b>	22W
<b>Power Factor</b>	0.98
<b>Color</b>	4000K
<b>Light Source</b>	Sharp COB LED

<b>Adapter</b>	H-Type (HALO), 3 Wire, 1 Circuit
<b>Dimmable</b>	Triac dimming
<b>Construction</b>	Die-cast aluminum with removable front cap for lenses or accessories
<b>Finish</b>	Powder coated Black and White

## Models

Track	Model No.	CCT Adjustable	Brightness (LM) Adjustable	CRI	Beam Angle	Finish
H Track	GL-TR-STD-22-H-B-4000K-40	4000K	1638LM	95+	40 °	Black
H Track	GL-TR-STD-22-H-W-4000K-40	4000K	1638LM	95+	40 °	White

## Packaging

Unit Box	Length x Width x Height	Net Weight
	7 <sup>3</sup> / <sub>16</sub> X 5 <sup>17</sup> / <sub>32</sub> X 4 <sup>11</sup> / <sub>32</sub> in	1.54lb

## Dimension

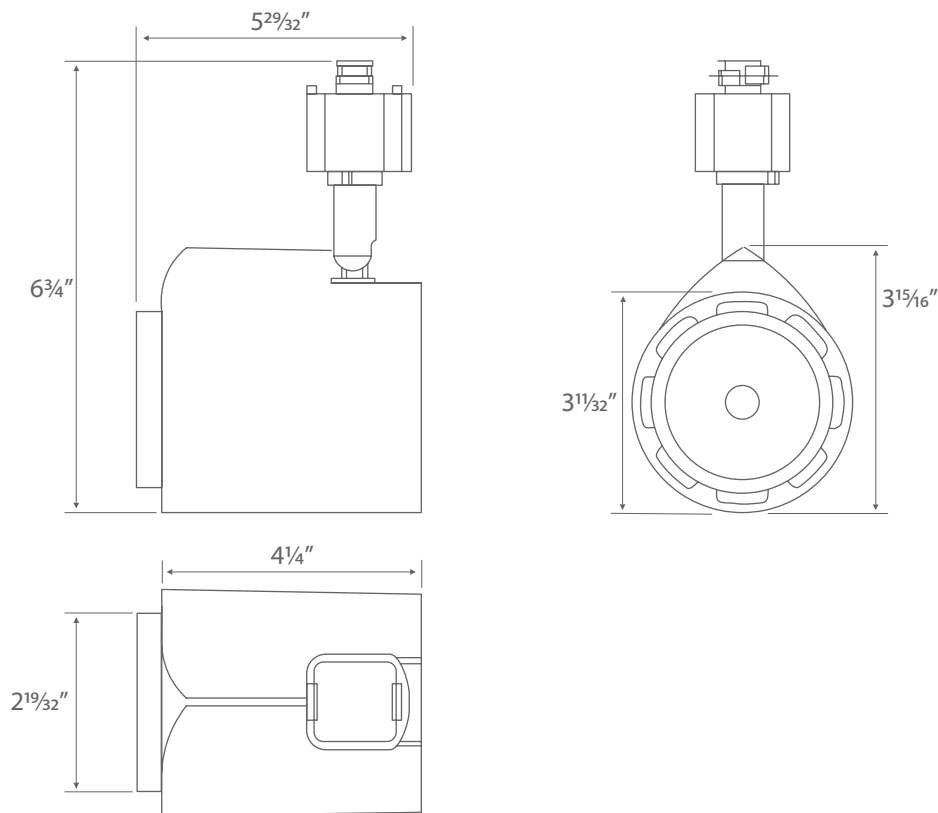

## Accessories (Sold Separately)

Lens can be changed with different beam angles.



Barn Door  
TK-BD1-B  
TK-BD1-W



Oval Snoot  
TK-OS1-B  
TK-OS1-W



Honeycomb  
TK-HC1-B  
TK-HC1-W



Snoot  
TK-SN1-B  
TK-SN1-W



15°, 24°, 60° Lens  
GL-TR-LENS-14W-22W-15  
GL-TR-LENS-14W-22W-24  
GL-TR-LENS-14W-22W-60