

LED Strip Light - White SPI

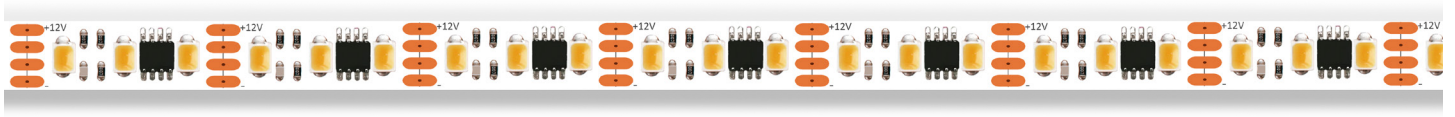

GL LED White SPI strip light features Smart IC Technology, enabling dynamic, water flowing, customizable lighting patterns and effects. Its slim 10mm design fits seamlessly into different mounting channels, catering to various lighting needs. The SPI strip light processes advanced breakpoint continuation transfer function to ensure the best overall lighting effects. This versatile SPI strip light is ideal for enhancing spaces such as display cases, retail shelving, outdoor billboards, signs, hotel lobbies, garden paths, hallway corridors, ceiling accents, architectural coves, theater aisles, and elevator interiors, etc.

Features

- Top-quality materials for enhanced durability and long-life span.
- Integrated with the external smart IC VS16703 on board, allowing for precise control of LEDs.
- Advanced breakpoint continuation transfer function - ensuring that any damaged individual LED will not affect the performance of the subsequent sections.
- High intensity of LEDs: 36 LEDs/ft.
- Dimmable with the PWM method; compatible with the SPI controller and DMX-SPI decoder.
- Easy installation featuring 3M VHB adhesive backing.
- 50,000-hour lifespan with a 5-year limited warranty.
- UL listed.



Specification

Input Voltage	12VDC		
Dimmable	SPI Signal		
Lead Wire	20 AWG, 2ft		
Color Temperature	2700K	3000K	4000K
Brightness	272 lm/ft	286 lm/ft	301 lm/ft
Light Efficacy	62 lm/W	65 lm/W	68 lm/W
Power Consumption	4.4W/ft		

LED Quantity	36 LEDs/ft
No Voltage Drop	16.4ft Max
LED Chip	2835
Operating Temperature	-4°F~113°F
Lumen Maintenance	50,000 hrs
CRI	90+
IP Rating	IP20 (Dry location)

Dimension

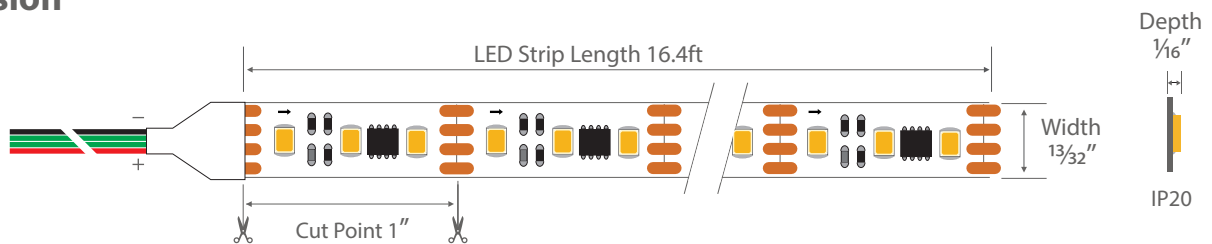

Important notice for wiring: the SPI data signal must be transferred from DI to DO strictly following the arrow printing on FPC, it can't be made by reverse connection, otherwise the strip will be out of control and even damaged.

Order Information

Series	Color Temperature	Voltage	IP Rating	Special Features
GL - 2835-120	27K-2700K 30K-3000K 40K-4000K	12V	IP20	SPI9643

GL LED US LIGHTING reserves the right to modify this specification without prior notices.

Voltage Drop Guidance Chart

This table provides general guidelines for determining Wire Gauge based on total load and distance from LED transformer to beginning of luminaire.

12V Voltage Drop & Wire Length Distance Chart (3% Drop or 11.64V)

Wire Gauge (AWG)	10W 0.83A	20W 1.7A	30W 2.5A	40W 3.3A	50W 4.2A	60W 5A
20	18ft	9ft	6ft	5ft	4ft	3ft
18	34ft	17ft	11ft	8ft	6ft	5ft
16	54ft	27ft	18ft	13ft	10ft	9ft











Step 1: Calculate Total Load: Check the power consumption of the LED light (e.g. 3W/ft). Calculate the total load of the LED light based on the light length (e.g. 10ft). The total load is 3W/ft x 10ft = 30W.

Step 2: Find Distance from Transformer to the Light Beginning: Check the distance between the transformer to the beginning of the light onsite. Let's assume it is 10ft. Round up to the nearest one on the table (Column 30W), which is 11ft.

Step 3: Choose Suitable Wire Gauge: According to the table (Column 30W & Row 11ft), it's recommended to use 18AWG or up wire between the transformer and LED light to eliminate voltage drop.

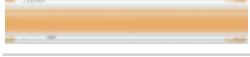
Note: This table is calculated based on the theoretical voltage drop formula. The wire quality, the LED light technology and environment conditions affect the result also. This table is only for reference.

LED Strip Light Comparison Chart

	Series	Features	Color Temperature	Input Voltage	Lumen Output	No Voltage Drop	Power	CRI
	DIM TO WARM	Light Efficiency 105LM/W	1800K~3000K	24VDC	Up to 462 lm/ft	16.4ft Max	4.4W/ft	97+
	INFINITE	Max Run 65.6ft	2700K, 3000K, 3500K, 4000K	24VDC	Up to 234 lm/ft	65.6ft Max	3W/ft	90+
	ECO	Cost Effective	2700K, 3000K, 4000K	12VDC	Up to 226 lm/ft	16.4ft Max	3W/ft	90+
	PRO	73 LEDs/ft	2700K, 3000K, 4000K	24VDC	Up to 575 lm/ft	16.4ft Max	4.4W/ft	90+
	LEGEND	Brightest CRI 94+	1800K, 2700K, 3000K, 4000K, 6500K, Blue, Red	24VDC	Up to 848 lm/ft	16.4ft Max	7W/ft	97+
	NARROW	0.2in Width	2700K, 3000K, 4000K	12VDC	Up to 339 lm/ft	16.4ft Max	3W/ft	90+
	COB	Seamless	2700K, 3000K, 4000K, 6500K	24VDC	Up to 416 lm/ft	16.4ft Max	4.4W/ft	90+
	FOR SAUNA	High temperature Resistance	2700K, 3000K, 4000K, 6000K	24VDC	Up to 287 lm/ft	16.4ft Max	3W/ft	90+
	SIDE BEND	Bendable & Cut Flexible	2700K, 3000K, 4000K, 6500K	12VDC	Up to 457 lm/ft	16.4ft Max	4.4W/ft	90+
	SPI	Light Chasing	2700K, 3000K, 4000K	12VDC	Up to 301 lm/ft	16.4ft Max	4.4W/ft	90+
	FOR BREAD	Fresh Bread	2500K	12VDC	Up to 200 lm/ft	16.4ft Max	4.4W/ft	97+
	FOR MEAT	Fresh Meat	2900K	12VDC	Up to 200 lm/ft	16.4ft Max	4.4W/ft	97+

Recommended Transformer (Sold Separately)

LED Non-Dimmable Transformer

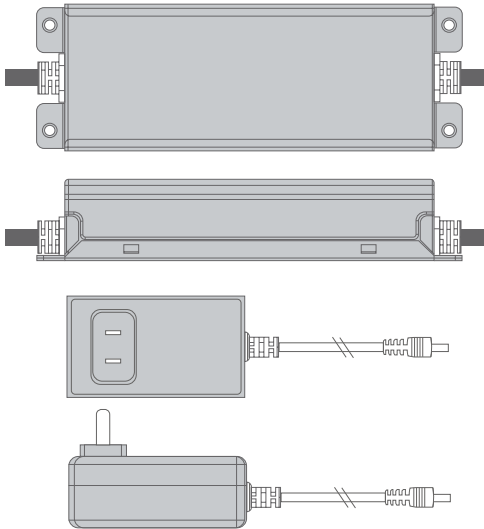

Model No.	Output Voltage	Wattage	Dimensions (L x W x H)	Certificates
APV-8W-12V	12V	8W	2.30x1.20x0.90in	CE, RU, Class 2
APV-35W-12V	12V	35W	3.30x2.20x1.20in	CE, RU, Class 2
FP-60W-12V	12V	60W	6.60x1.80x1.30in	CE, RU, Class 2
XLG-100W-12V	12V	100W	5.51x2.48x1.26in	CE, RU
XLG-150W-12V	12V	150W	7.09x2.48x1.40in	CE, RU

Model No.	Output Voltage	Wattage	Dimensions (L x W x H)	Certificates
DVE-12W-12V	12V	12W	3.70x1.70x1.80in	UL, FCC, CE
TPS-36W-12V	12V	36W	3.70x1.70x1.80in	UL, FCC, CE
TPZ-60W-12V	12V	60W	3.70x1.70x1.80in	UL, FCC, CE
TPZ-96W-12V	12V	96W	7.00x3.10x1.80in	UL, FCC, CE

Parallel Connection

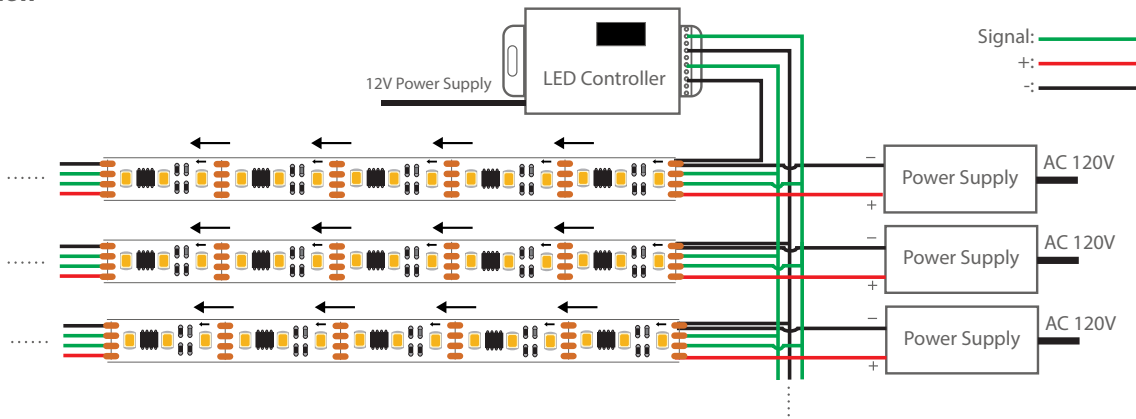

Series Connection

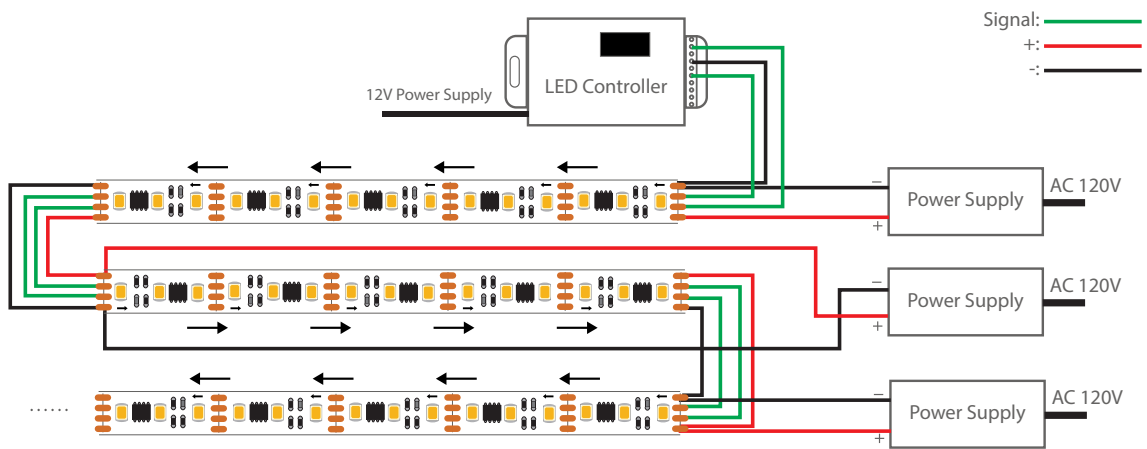

*Depending on the types of SPI controllers, a single controller can manage a specific number of ICs. If there is a need to control more ICs than a single controller can handle, additional controllers will be required.

Aluminum Channel Options (Sold Separately)

