

LED Strip Light - RGB SPI

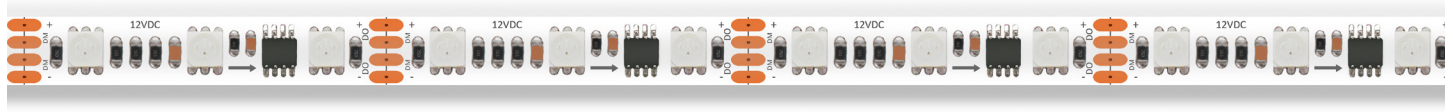

This SPI design LED RGB strip light is great for party, entertainments, and decoration. The 3M VHB adhesive backing makes it easy for installation.

Features

- Slim, flexible and cuttable design allows for easy installation and illuminates every edge with light.
- SPI design LED RGB strip light.
- Easy installation featuring 3M VHB adhesive backing.
- High brightness with color changing output, suitable for party, entertainment and decoration.
- 50,000h long lifespan with 5 years limited warranty.
- UL listed.



Specification

Input Voltage	12VDC
Controller	RGB SPI Controller
Lead Wire	20 AWG, 2ft (6 wires)
Color	RGB
Brightness	Up to 144lm/ft
Light Efficacy	Up to 33lm/W
Power Consumption	4.4W/ft

LED Quantity	18 LEDs/ft
No Voltage Drop	16.4 ft Max
LED Chip	5050
Operating Temperature	-13°F~104°F
Lumen Maintenance	50,000 hrs
IP Rating	IP20 (Dry location)

Dimension

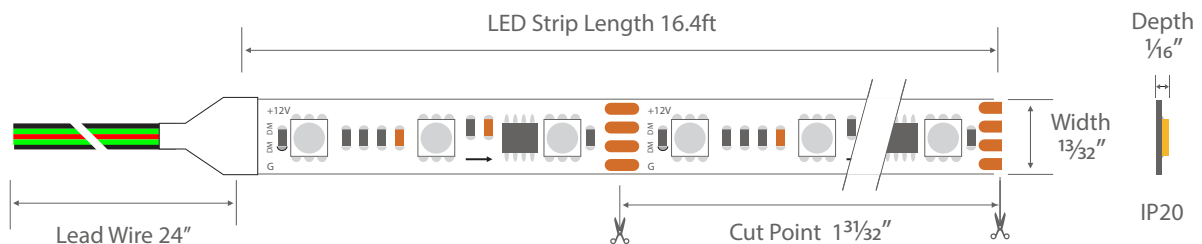

Order Information

GL — **LED Type** — **LED Quantity per Meter** — **Color** — **Voltage** — **IP Rate**

Voltage Drop Guidance Chart

This table provides general guidelines for determining Wire Gauge based on total load and distance from LED transformer to beginning of luminaire.

12V Voltage Drop & Wire Length Distance Chart (3% Drop or 11.64V)

Wire Gauge (AWG)	10W 0.83A	20W 1.7A	30W 2.5A	40W 3.3A	50W 4.2A	60W 5A
20	18ft	9ft	6ft	5ft	4ft	3ft
18	34ft	17ft	11ft	8ft	6ft	5ft
16	54ft	27ft	18ft	13ft	10ft	9ft





Step 1: Calculate Total Load: Check the power consumption of the LED light (e.g. 3W/ft). Calculate the total load of the LED light based on the light length (e.g. 10ft). The total load is 3W/ft x 10ft = 30W.

Step 2: Find Distance from Transformer to the Light Beginning: Check the distance between the transformer to the beginning of the light onsite. Let's assume it is 10ft. Round up to the nearest one on the table (Column 30W), which is 11ft.

Step 3: Choose Suitable Wire Gauge: According to the table (Column 30W & Row 11ft), it's recommended to use 18AWG or up wire between the transformer and LED light to eliminate voltage drop.

Note: This table is calculated based on the theoretical voltage drop formula. The wire quality, the LED light technology and environment conditions affect the result also. This table is only for reference.

LED Strip Light Comparison

	Series	Features	Color	Input Voltage	Lumen Output	No Voltage Drop	Power
	RGB HIGH BRIGHT	12V/24V	RGB	24VDC	Up to 144 lm/ft	16.4ft Max	4.4W/ft
	RGB SUPER BRIGHT	Brightest High Density	RGB	24VDC	Up to 221 lm/ft	16.4ft Max	7W/ft
	RGBW	RGB with White	RGB+ 2900K ~ 3200K, RGB+ 6000K ~ 6500K	24VDC	Up to 295 lm/ft	16.4ft Max	7W/ft
	RGB SPI	Color Chasing	RGB	12VDC	Up to 144 lm/ft	16.4ft Max	4.4W/ft

Recommended Transformer (Sold Separately)

LED Non-Dimmable Transformer

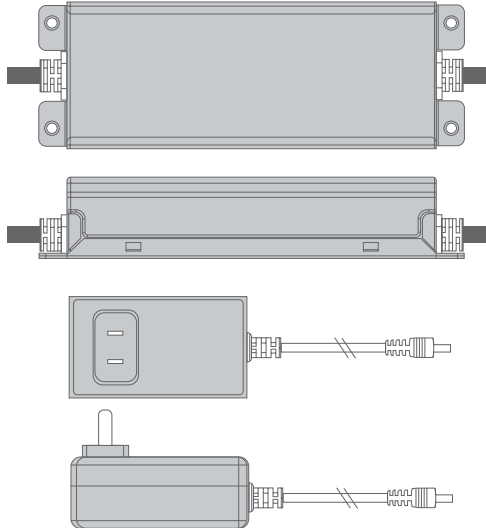

Model No.	Output Voltage	Wattage	Dimensions (L x W x H)	Certificates
APV-8W-12V	12V	8W	2.30x1.20x0.90in	CE, RU, Class 2
APV-35W-12V	12V	35W	3.30x2.20x1.20in	CE, RU, Class 2
FP-60W-12V	12V	60W	6.60x1.80x1.30in	CE, RU, Class 2
XLG-100W-12V	12V	100W	5.51x2.48x1.26in	CE, RU
XLG-150W-12V	12V	150W	7.09x2.48x1.40in	CE, RU

Model No.	Output Voltage	Wattage	Dimensions (L x W x H)	Certificates
DVE-12W-12V	12V	12W	3.70x1.70x1.80in	UL, FCC, CE
TPS-36W-12V	12V	36W	3.70x1.70x1.80in	UL, FCC, CE
TPZ-60W-12V	12V	60W	3.70x1.70x1.80in	UL, FCC, CE
TPZ-96W-12V	12V	96W	7.00x3.10x1.80in	UL, FCC, CE

Parallel Connection

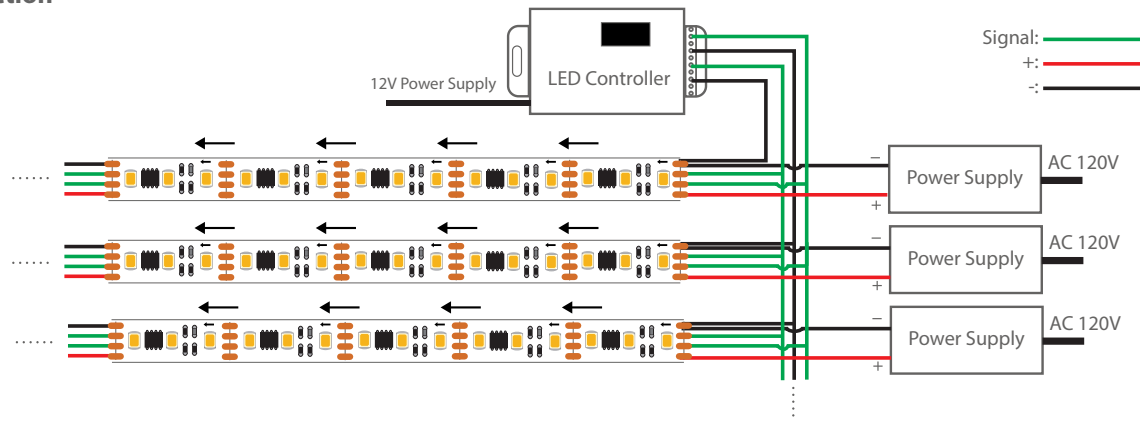

Series Connection

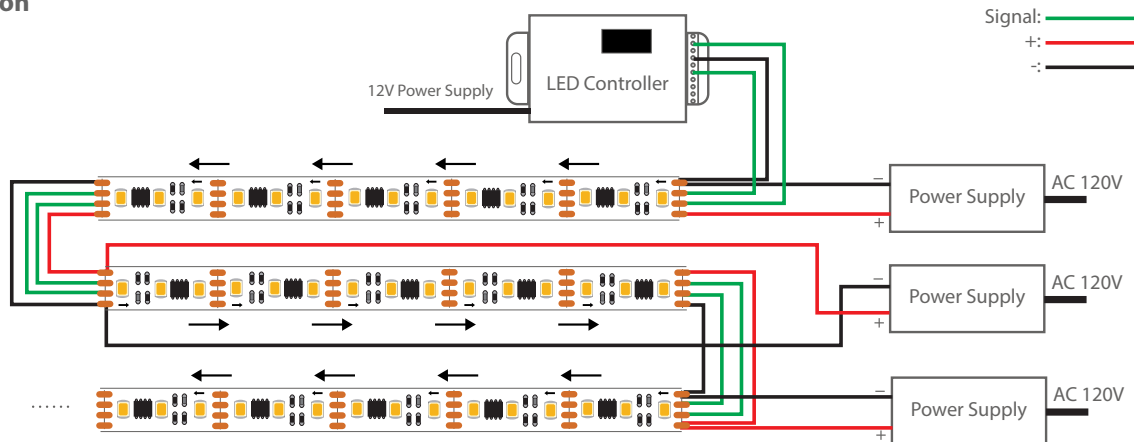

Non-Dimmable Transformer Diagram with RGB Digital Controller

*This diagram is for references only. Please see the LED RGB Controller Specification for a more accurate diagram.

Aluminum Channel Options (Sold Separately)

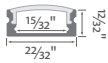

ES 1709 / YD 1205

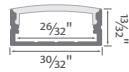

YD 2002

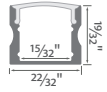

ES 1715

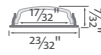

YD 1806



ES 1616 / YD 1002

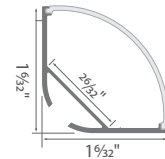

YD 2004

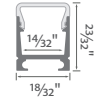

YD 1418

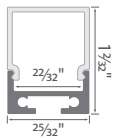

YD 1604

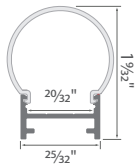

A 2033

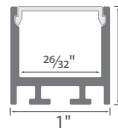

A 2525

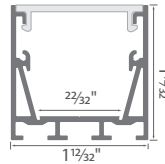

ES 3535

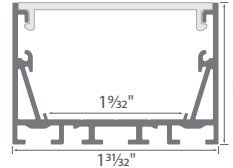

ES 5035

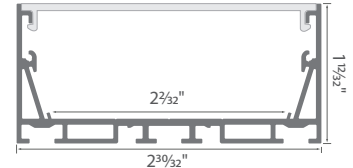

ES 7535

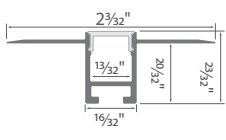

GL 079

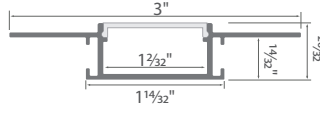

YD 7615

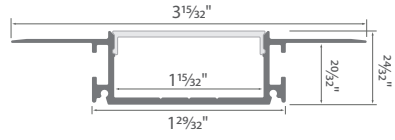

GL 081

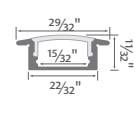

ES 2309

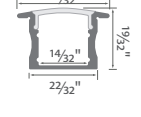

ES 2315 / YD 1201

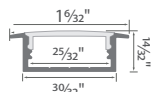

ES 3011

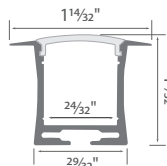

GL 031

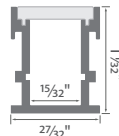

GL 034

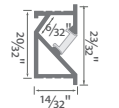

JH 1716

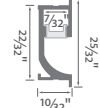

JH 1722

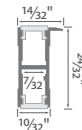

JH 1713

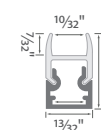

JH 1686

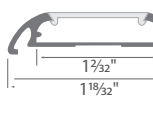

YD 2601

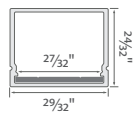

A 2319

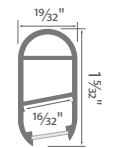

YD 1401

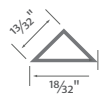

LX 1410

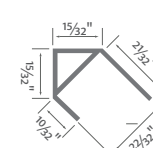

LX 1420

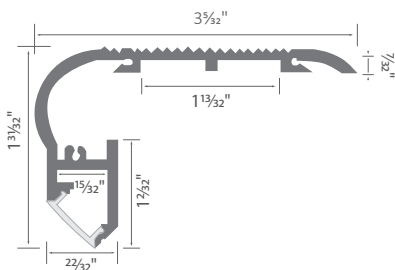

GL 024

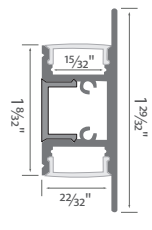

GL 050

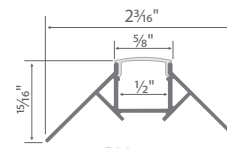

BY 5324

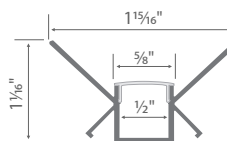

BY 5026

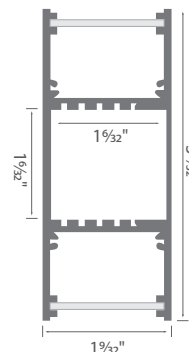

GL 049

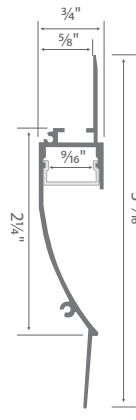

BY 9819

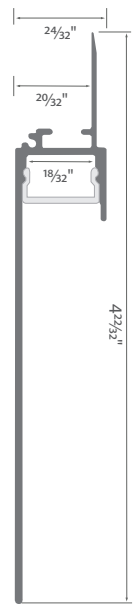

GL 085