

LED Aluminum Channel - SLIM FLAT ES 1709

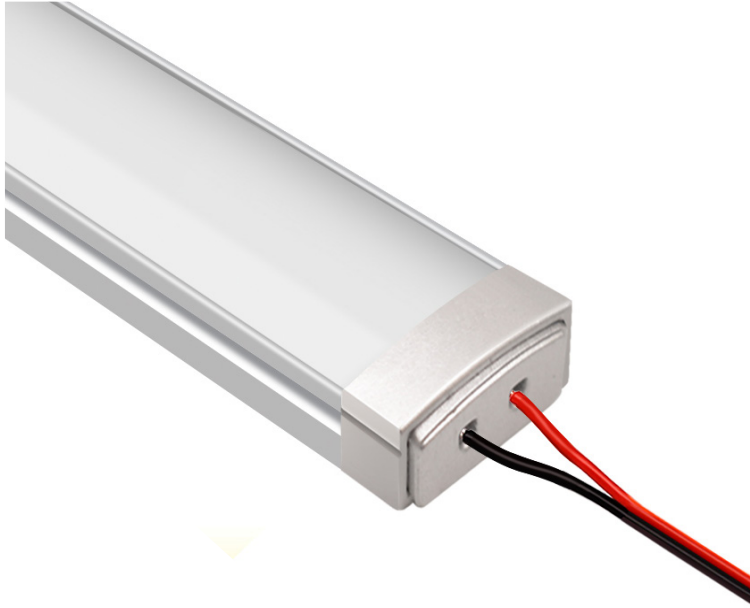

Slim Flat ES 1709 is ideal for general low-profile surface mounting of LED strip light. With silver finishing and milky diffuser, ES 1709 complements a wide variety of applications.

Features

- Slim and Flat
- Customizable.
- Anodized finish.
- Slim, low profile design.
- Covers and protect LED strip light.
- Manufactured with a patented frosted diffuser for maximum lumen output and wider beam distribution.

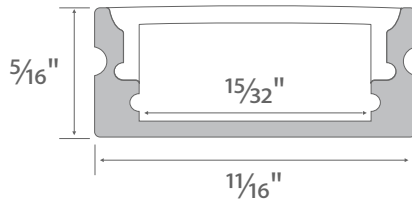

Specification

Length	94in
Internal width	0.49in
Finish	Silver
Diffuser	Milky
Material	Anodized Aluminum
Installation	Surface Mount
Accessories	End cap, Mounting clip

Models

Model No.	Finish Color	Diffuser Type	Dimension (L x W xH)	Application
ES-1709-AL-8-M	Silver	Milky	94x0.68x0.28in	Indoor, Outdoor

Accessories (Sold Separately)

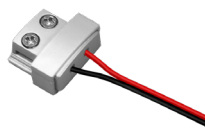

Solder Free End Caps
ES-1709-EC



ES 1709 Mounting Clip
ES-1709-MC

Installation Diagram

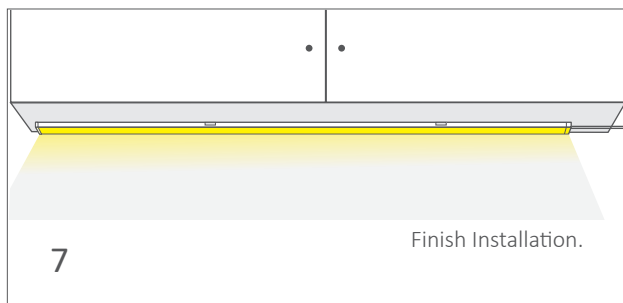
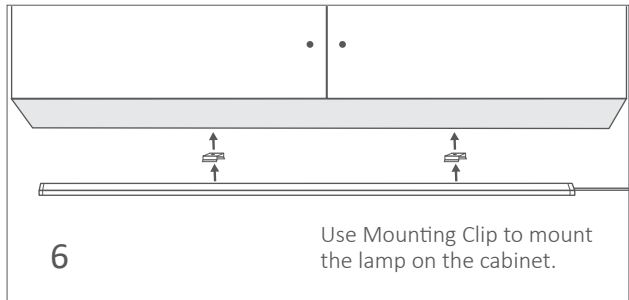
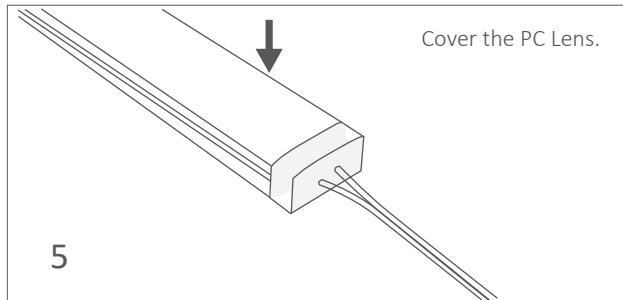
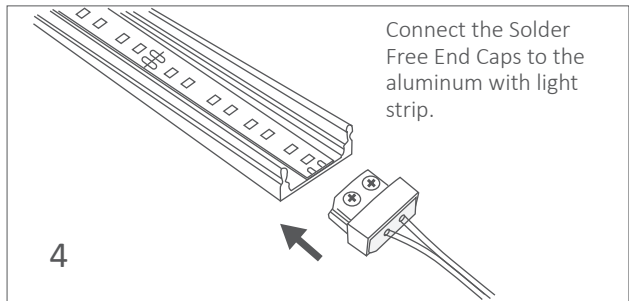
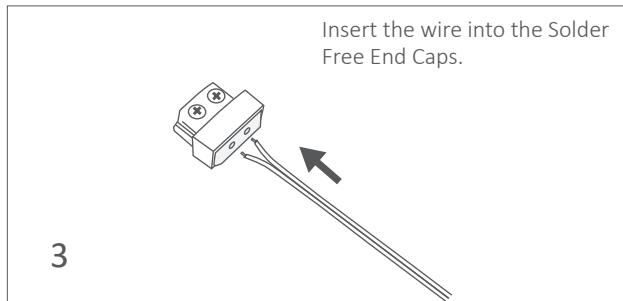
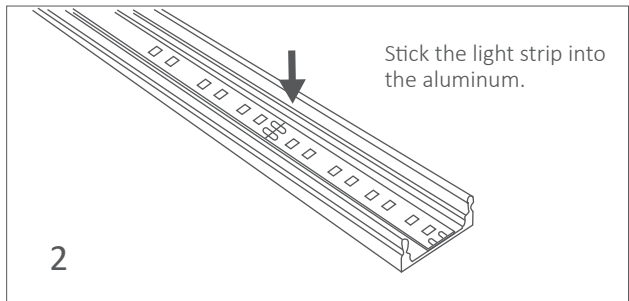
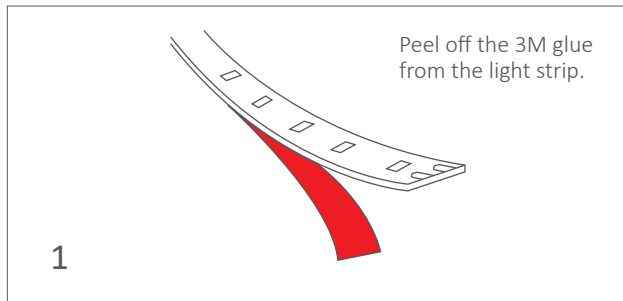

Mounting Options

Surface Mount

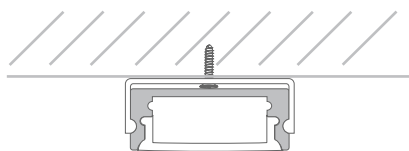

Surface mounting with Mounting Clips

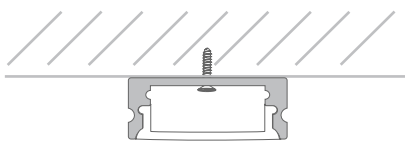



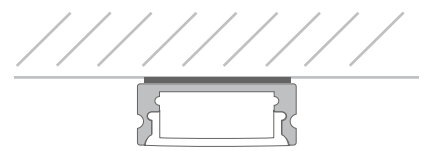







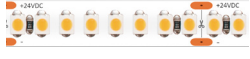

Surface mounting with Screws

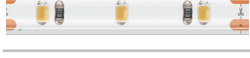

Surface mounting with 3M Tape

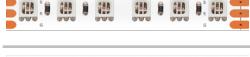
Compatible LED Strip Lights

	Series	Model No.	Width	LED Quantity	Light Filling Level	Hotspots Level
	INFINITE	GL-3528-120-xxxxK-24V-IP20-CC	0.39in	34 LEDs/ft	Full	Hotspot
	ECO	GL-3528-112-xxxxK-xxV-IPxx	0.39in	34 LEDs/ft	Full	Hotspot
	PRO	GL-3528-240-xxxxK-24V-IPxx	0.39in	73 LEDs/ft	Full	No Hotspot
	LEGEND	GL-2835-240-xxxxK-24V-IPxx	0.39in	73 LEDs/ft	Full	No Hotspot
	NARROW	GL-3528-120-xxxxK-12V-IP20-5MM	0.2in	36 LEDs/ft	Full	Hotspot
	COB	GL-COB-480-xxxxK-24V-IP20	0.39in	145 LEDs/ft	Full	No Hotspot
	TUNABLE WHITE	GL-2835-240-CCT-24V-IP20	0.39in	73 LEDs/ft	Full	Hotspot
	FOR BREAD	GL-2835-60-2500K-12V-IP20-B	0.39in	18 LEDs/ft	Full	Hotspot
	FOR MEAT	GL-2835-60-2900K-12V-IP67-M	0.39in	18 LEDs/ft	Full	Hotspot
	RGB HIGH BRIGHT	GL-5050-60-RGB-xxV-IPxx	0.39in	18 LEDs/ft	Full	Hotspot
	RGB SUPER BRIGHT	GL-3535-120-RGB-24V-IPxx	0.39in	34 LEDs/ft	Full	Hotspot
	RGBW	GL-5050-96-RGB+xxxxK-24V-IP20	0.47in	29 LEDs/ft	Full	Hotspot
	RGB DIGITAL	GL-5050-60-DIG-12V-IPxx	0.39in	18 LEDs/ft	Full	Hotspot

Light Filling Level



Full



Partial

Hotspots Visible Level



No Hotspot



Partial Hotspot



Hotspot

Note:

We recommend to use two, or more, LED strips in a shallow channel that has internal width that is greater than .8in to prevent partial filling.

Note:

When LEDs are used with aluminum channel there may be hot spots. The more depth of a channel, and/or density of a LED, can help reduce visible hot spots