

LED Strip Light -- LEGEND Series



This LED Light strip is perfect for retail shops, jewelry cases, supermarkets, food and meat cases, museums, galleries, videography, under-cabinet lighting, or any indoor applications where presentation, appearance, and depth of color are critical.

Features

- Slim, flexible and cuttable design allows for easy installation and illuminates every edge with light.
- Superior brightness output and no hotspot with high density LEDs for commercial-grade lighting at 97+ CRI.
- Easy installation featuring 3M VHB adhesive backing.
- Dimmable available with PWM, Forward phase, Triac, 0-10V, MLV, ELV.
- 50,000h long lifespan with 5 years limited warranty.
- UL listed.



Specification

Input Voltage	24VDC						
Dimmable	PWM, Forward phase, Triac, 0-10V, MLV, ELV						
Lead Wire	20 AWG, 2ft (2 Wires)						
Color Temperature	1800K	2700K	3200K	4000K	6500K	Blue	Red
Brightness	736lm/ft	806lm/ft	806lm/ft	848lm/ft	820lm/ft	40lm/ft	91lm/ft
Light Efficacy	105lm/W	115lm/W	115lm/W	121lm/W	117lm/W	6lm/W	13lm/W
CRI	97+					N/A	

LED Quantity	73 LEDs/ft
No Voltage Drop	16.4 ft Max
LED Chip	2835
Operating Temperature	-13°F~104°F
Lumen Maintenance	50,000 hrs
Power Consumption	7W/ft
IP Rating	IP20 (Dry location)

Dimension

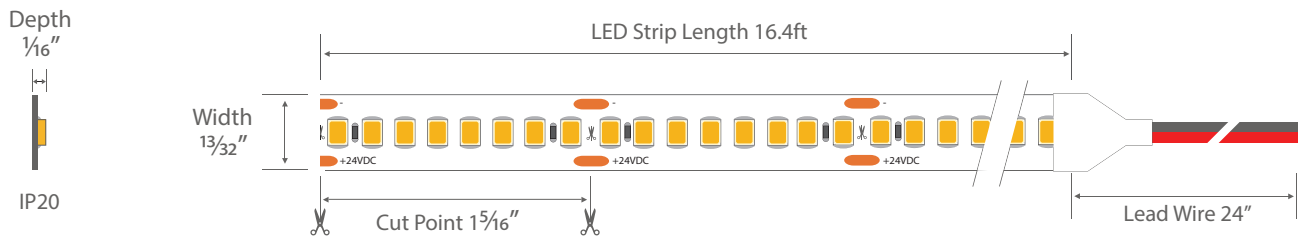

Order Information

LED Type	LED Quantity per Meter	Color Temperature	Voltage	IP Rate
GL - 2835	240	1800K 2700K 3200K 4000K 6500K BLUE RED	24-24VDC	IP20-Nonwaterproof

GL LED US LIGHTING reserves the right to modify this specification without prior notices.

Voltage Drop Guidance Chart

This table provides general guidelines for determining Wire Gauge based on total load and distance from LED transformer to beginning of luminaire.

24V Voltage Drop & Wire Length Distance Chart (3% Drop or 23.28V)

Wire Gauge (AWG)	10W 0.42A	20W 0.83A	30W 1.3A	40W 1.7A	50W 2.1A	60W 2.5A	70W 2.9A	80W 3.3A	90W 3.75A	100W 4.2A
20	85ft	43ft	27ft	21ft	17ft	14ft	12ft	11ft	9ft	8ft
18	134ft	68ft	45ft	33ft	27ft	22ft	19ft	17ft	15ft	14ft
16	215ft	109ft	72ft	54ft	43ft	36ft	31ft	27ft	24ft	22ft







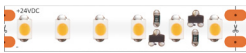

Step 1: Calculate Total Load: Check the power consumption of the LED light (e.g. 3W/ft). Calculate the total load of the LED light based on the light length (e.g. 10ft). The total load is 3W/ft x 10ft = 30W.

Step 2: Find Distance from Transformer to the Light Beginning: Check the distance between the transformer to the beginning of the light onsite. Let's assume it is 40ft. Round up to the nearest one on the table (Column 30W), which is 45ft.

Step 3: Choose Suitable Wire Gauge: According to the table (Column 30W & Row 45ft), it's recommended to use 18AWG or up wire between the transformer and LED light to eliminate voltage drop.

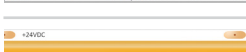
Note: This table is calculated based on the theoretical voltage drop formula. The wire quality, the LED light technology and environment conditions affect the result also. This table is only for reference.

LED Strip Light Comparison Chart

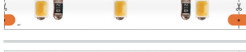
	Series	Features	Color Temperature	Input Voltage	Lumen Output	No Voltage Drop	Power	CRI
	DIM TO WARM	Light Efficiency 105LM/W	1800K~3000K	24VDC	Up to 462 lm/ft	16.4ft Max	4.4W/ft	97+
	INFINITE	Max Run 65.6ft	2700K, 3000K, 3500K, 4000K	24VDC	Up to 234 lm/ft	65.6ft Max	3W/ft	90+
	ECO	Cost Effective	2700K, 3000K, 4000K	12VDC	Up to 226 lm/ft	16.4ft Max	3W/ft	90+
	PRO	73 LEDs/ft	2700K, 3000K, 4000K	24VDC	Up to 575 lm/ft	16.4ft Max	4.4W/ft	90+
	LEGEND	Brightest CRI 94+	1800K, 2700K, 3000K, 4000K, 6500K, Blue, Red	24VDC	Up to 848 lm/ft	16.4ft Max	7W/ft	97+
	NARROW	0.2in Width	2700K, 3000K, 4000K	12VDC	Up to 339 lm/ft	16.4ft Max	3W/ft	90+
	COB	Seamless	2700K, 3000K, 4000K, 6500K	24VDC	Up to 416 lm/ft	16.4ft Max	4.4W/ft	90+
	FOR SAUNA	High temperature Resistance	2700K, 3000K, 4000K, 6000K	24VDC	Up to 287 lm/ft	16.4ft Max	3W/ft	90+
	SIDE BEND	Bendable & Cut Flexible	2700K, 3000K, 4000K, 6500K	12VDC	Up to 457 lm/ft	16.4ft Max	4.4W/ft	90+
	TUNABLE WHITE	Tunable	1800K-6500K	24VDC	Up to 498 lm/ft	16.4ft Max	7W/ft	97+
	FOR BREAD	Fresh Bread	2500K	12VDC	Up to 200 lm/ft	16.4ft Max	4.4W/ft	97+
	FOR MEAT	Fresh Meat	2900K	12VDC	Up to 200 lm/ft	16.4ft Max	4.4W/ft	97+

Accessories (Sold Separately)

STA3 Series provide an easier and more secure connection for Low Voltage LED strip lights.

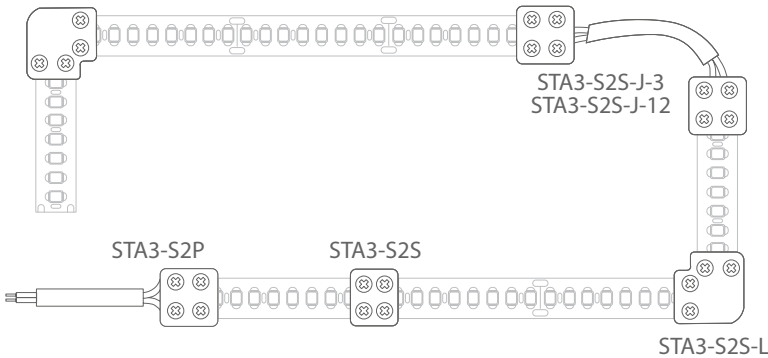
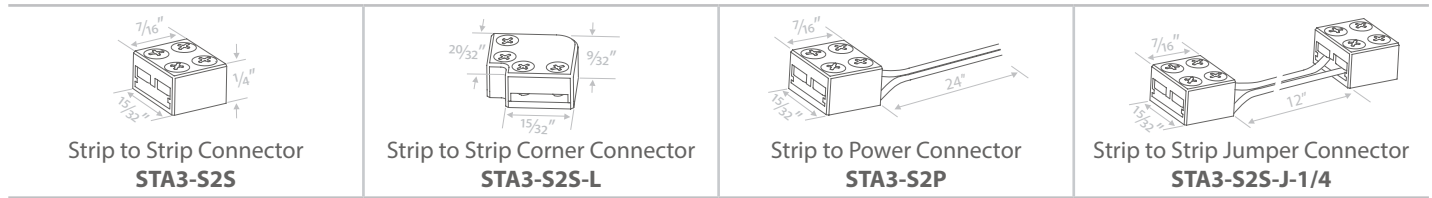

- Solderless screw tight.
- Load large current, up to 10A.
- Suitable for width 0.31 and 0.39in LED strip light.
- Suitable for both low density and high density LED strip light.
- All STA3 connectors are **Non-Waterproof**. Extra steps are needed when connecting waterproof strip lights.

Recommended Transformer (Sold Separately)

LED Dimmable Transformer - 5 in 1 dimming
G Series

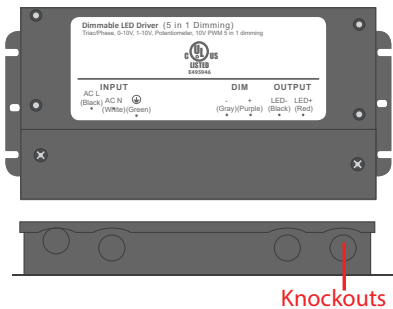

Model No.	Output Voltage	Wattage	Dimensions (L x W x H)	Certificates
G-60W-24V	24V	60W	7 ¹ / ₃₂ "x3 ³ / ₄ "x1 ³ / ₄ "	FCC, UL, Class 2
G-96W-24V	24V	96W	8 ² / ₃₂ "x3 ³ / ₄ "x1 ²³ / ₃₂ "	FCC, UL, Class 2
G-150W-24V	24V	150W	10 ⁹ / ₃₂ "x4 ⁵ / ₃₂ "x1 ¹⁵ / ₁₆ "	FCC, UL, Class 2
G-200W-24V	24V	200W	10 ⁹ / ₃₂ "x4 ⁵ / ₃₂ "x1 ¹⁵ / ₁₆ "	FCC, UL, Class 2
G-300W-24V	24V	300W	10 ⁹ / ₃₂ "x4 ⁵ / ₃₂ "x1 ¹⁵ / ₁₆ "	FCC, UL, Class 2

LED Non-Dimmable Transformer

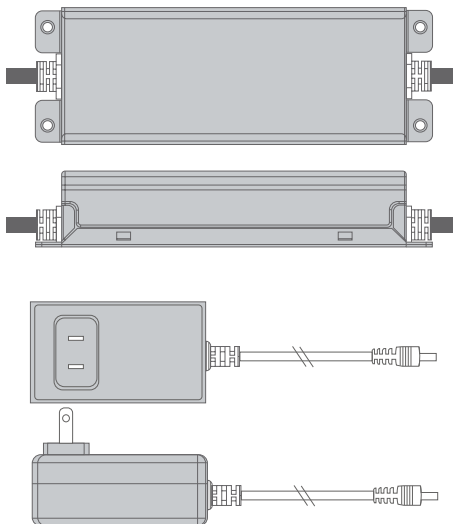

Model No.	Output Voltage	Wattage	Dimensions (L x W x H)	Certificates
APV-8W-24V	24V	8W	2.30x1.20x0.90in	CE, RU, Class 2
APV-35W-24V	24V	35W	3.30x2.20x1.20in	CE, RU, Class 2
LPV-60W-24V	24V	60W	6.40x1.70x1.30in	CE, RU, Class 2
XLG-100W-24V	24V	100W	5.50x2.50x1.25in	CE, RU
XLG-150W-24V	24V	150W	5.51x2.48x1.26in	CE, RU
XLG-200W-24V	24V	200W	7.09x2.48x1.40in	CE, RU
HLG-320W-24V	24V	320W	9.90x3.50x1.70in	CE, RU
HLG-600W-24V	24V	600W	11.00x5.70x1.90in	CE, RU

Model No.	Output Voltage	Wattage	Dimensions (L x W x H)	Certificates
YHY-36W-24V	24V	36W	3.40x1.90x1.25in	UL, FCC, CE
YHY-60W-24V	24V	60W	4.50x1.90x1.20in	UL, FCC, CE
TPZ-96W-24V	24V	96W	7.00x3.10x1.80in	UL, FCC, CE

Aluminum Channel Options (Sold Separately)

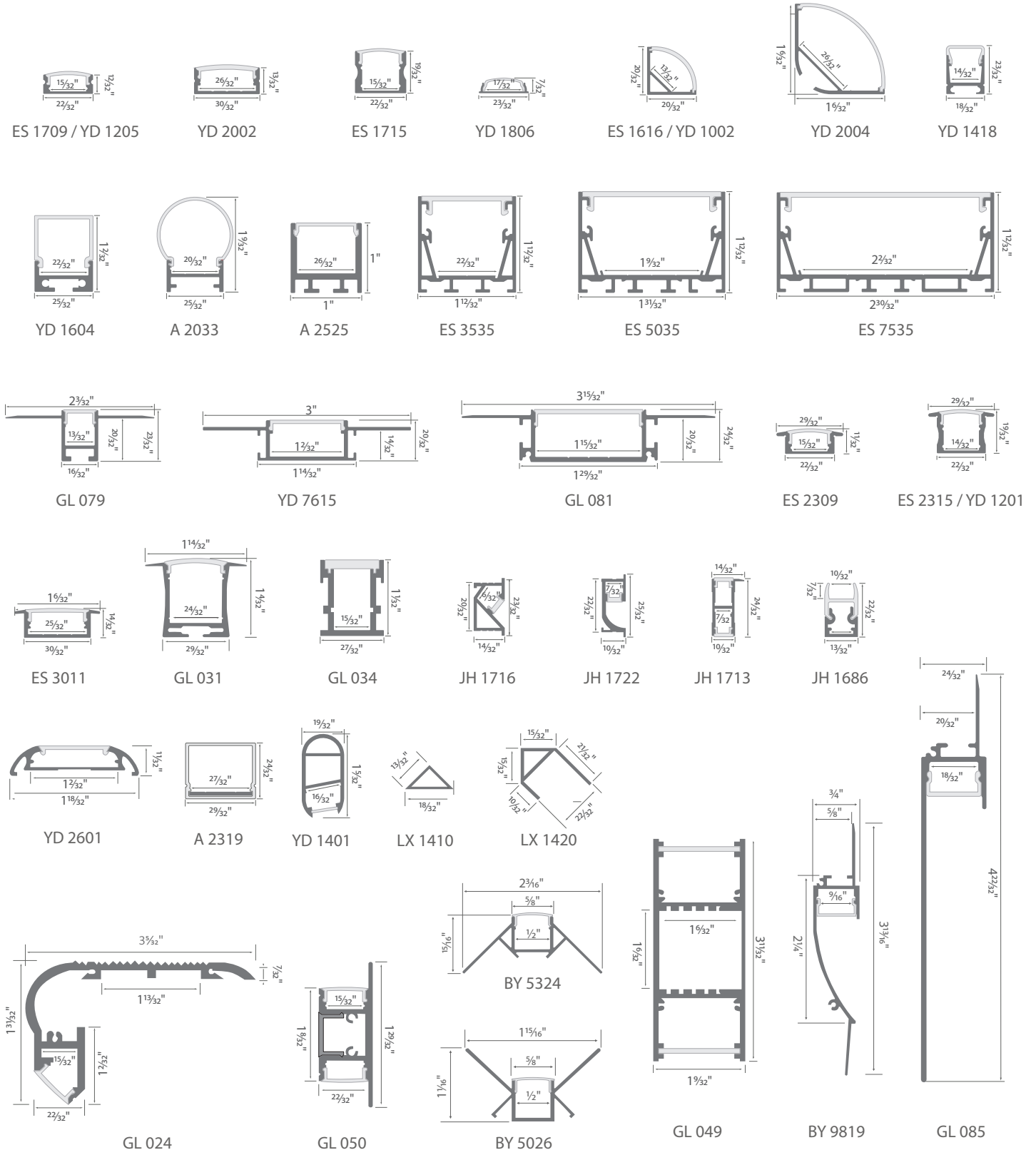

GL LED US LIGHTING reserves the right to modify this specification without prior notices.