

120V LED Strip Light - COB Series

The GL LED 120V COB Strip Light, a premium and driverless lighting product, seamlessly integrates with line voltage to provide consistent, dot-free lighting with a superior CRI (>90). Capable of extending up to 100 feet using a single power source without any voltage drop, this strip light is ideal for both indoor and outdoor settings, as well as for direct and indirect lighting needs, making it perfect for extensive cove lighting and backlighting projects.

Features

- Provides a seamless, dot-free linear LED light.
- Features constant current and overvoltage protection.
- Direct line voltage connection, eliminating the need for an AC to DC transformer.
- Compatible with ELV dimmers.
- Constructed with IP65 PVC extrusion; available in minimum 6-inch sections, extendable up to 100 feet without voltage drop.
- Easy installation with one-sided power cord.
- UL certified, 5-year indoor and 3-year outdoor warranty.



Specification

Input Voltage	120VAC		
Dimmable	ELV		
Color	2700K	3000K	4000K
Brightness	247lm/ft	280lm/ft	282lm/ft
Light Efficacy	55lm/W	62lm/W	63lm/W
Power Consumption	4.5W/ft		
CRI	90+		

LED Quantity	180 LEDs/ft
One Run Max	100ft
LED Chip	COB 9V
Operating Temperature	-4°F ~ 107°F
Lumen Maintenance	50,000 hrs
IP Rating	IP65 (Wet location)

Dimension

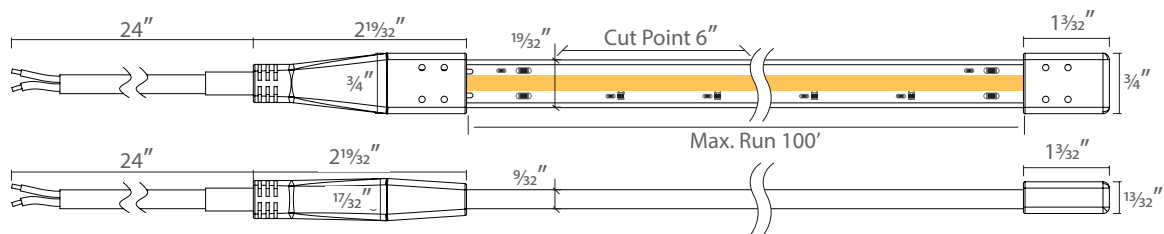

Order Information

Series	Voltage	Color Temperature	Power Cable	Length(ft)	Length(in)
GL - LV-COB	120V	27K-2700K 30K-3000K 40K-4000K	RF-Rear Feed Hard Wire RFP-Rear Feed with Plug BF-Bottom Feed Hard Wire	0-0ft 1-1ft 2-2ft 3-3ft 4-4ft ... 100-100ft	0-0in 6-6in

GL LED US LIGHTING reserves the right to modify this specification without prior notices.

Connecting Accessories

Since the 120V Strip Light is a **customized** light with factory cut and assembling, the connection accessories are not sold separately. Please add the required quantity in the order.

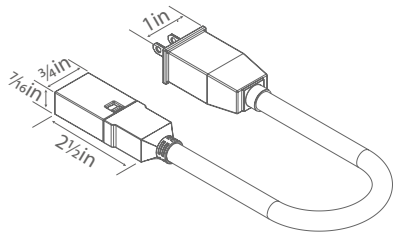

Plug-in Power Cable
GL-LV-PC

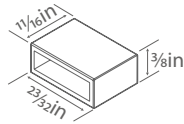

End Cap
GL-LV-EC

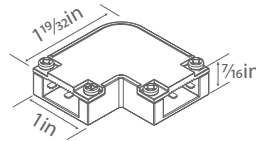

Corner Connector
GL-LV-CC

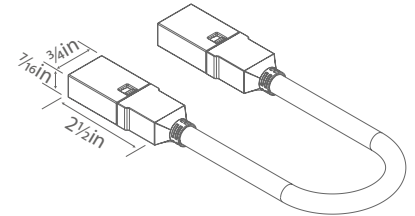

Jumper Cable
GL-LV-JP-1/2
GL-LV-JP-2

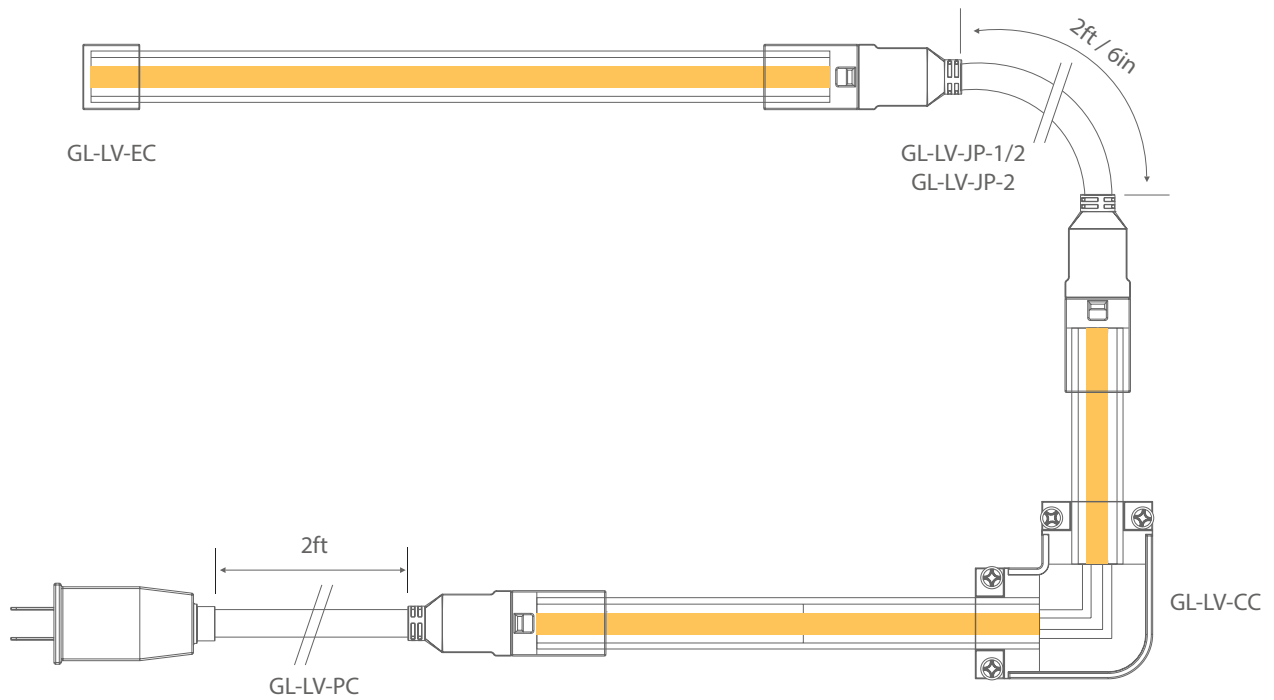

Installation Accessories (Sold Separately)

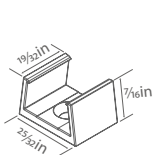

Mounting Clip
GL-LV-MCL-V2

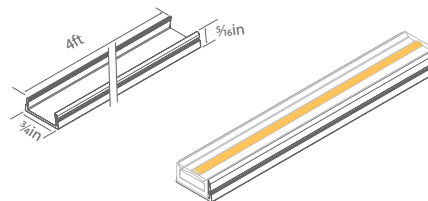

Mounting Channel
GL-LV-MCH-4

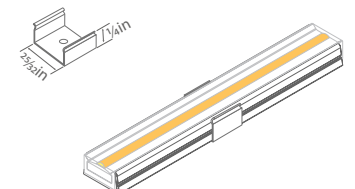

Channel Mounting Clip
GL-LV-MCHC

Compatible Aluminum Channel (Sold Separately)

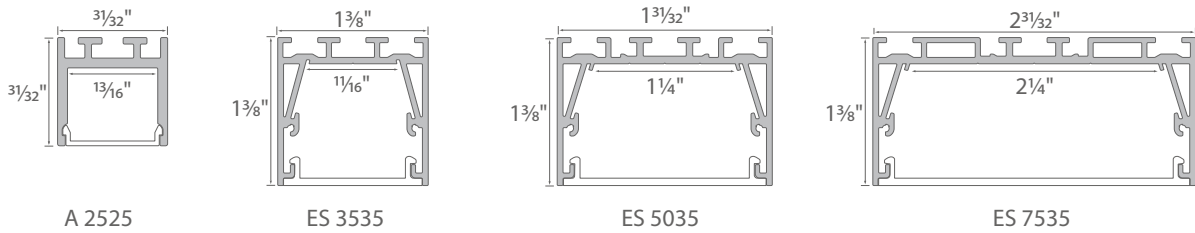

Aluminum Channel	Series	Model No.	Accessories	Hotspot	Recommended # of Strips
A2525 LINEAR	A 2525	A-2525-AL-8-M	End cap, Mounting	No Hotspots	1 strip
3535 LINEAR	ES 3535	ES-3535-AL-8-M	End cap, Mounting, Connecting	No Hotspots	1 strip
5035 LINEAR	ES 5035	ES-5035-AL-8-M	End cap, Mounting, Connecting	No Hotspots	2 strips
7535 LINEAR	ES 7535	ES-7535-AL-8-M	End cap, Mounting, Connecting	No Hotspots	3 strips

Special Assesories (For A 2525 Only)

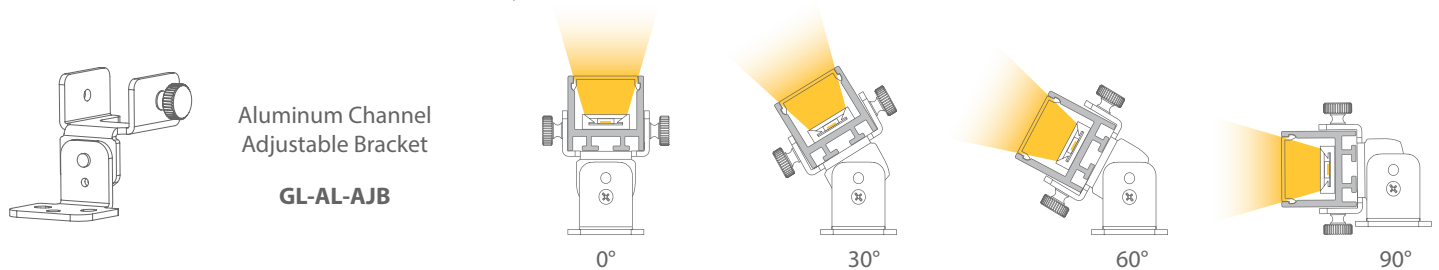

Aluminum Channel Mounting Options

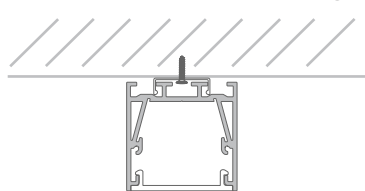

Surface Mounting

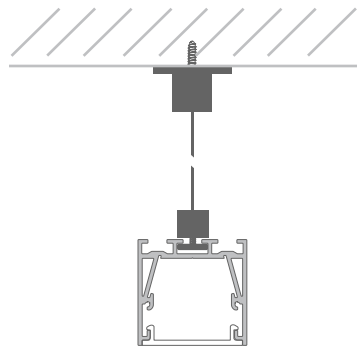

Suspended Mounting

*For more detailed Aluminum channel information, please see LED aluminum channel specification of each series.

Bending Options & Precautions

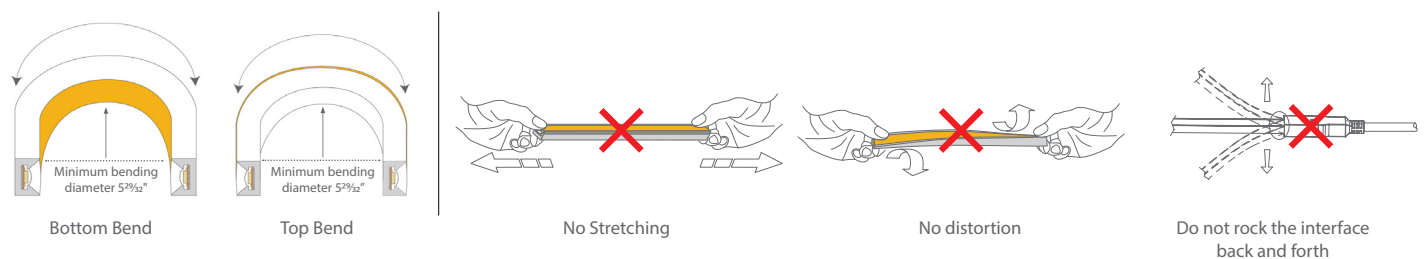

GL LED US LIGHTING reserves the right to modify this specification without prior notices.