

PRINT INSTRUCTION

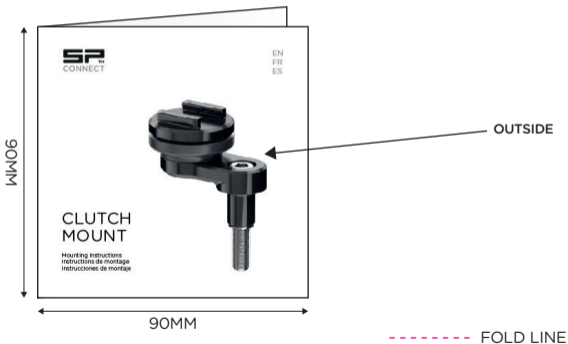

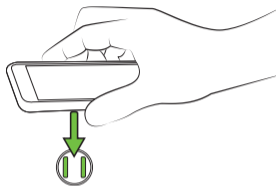

SP Connect is a registered trademark © 2018 SP United / PATENT PENDING SYSTEM / All rights reserved FR: SP Connect est une marque déposée © 2018 SP United / système avec brevet en instance / Tous droits réservés ES: SP Connect es una marca registrada © 2018 SP United / sistema con patentes pendientes / Todos los derechos reservados

SPTM
CONNECT

EN
FR
ES

CLUTCH MOUNT

Mounting instructions
Instructions de montage
Instrucciones de montaje



1. Choose correct screw for motorcycle type (M6 or UNC 1/4" - 20)
Choisissez la bonne vis pour le type de moto
Elija el tornillo correcto para el tipo de motocicleta

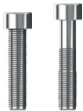

Tighten screw to motorcycle manufacturer guidelines
Serrez la vis selon les instructions du fabricant de la moto
Apretar el tornillo de acuerdo con las instrucciones del fabricante de la motocicleta

2. Choose mounting position
Choisir position
Elegir la posición

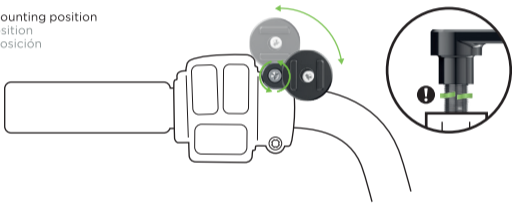

3. Adjust Micro Rail Head
Ajuster la tête
Ajustar la cabeza

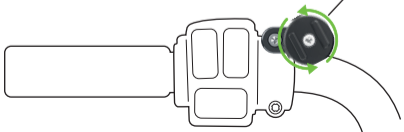

4. Place Phone
Placez le téléphone
Coloque el teléfono

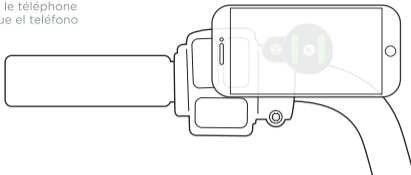

5. Turn 90° Clockwise
Tournez le à 90 degrés
Giralo 90°

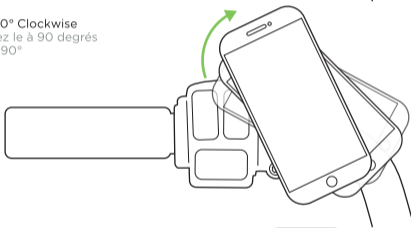

6. Locked!
Serrure
Bloquear

