



INSTALLATION & OPERATION MANUAL

LOW VOLTAGE PANS & BURNERS



**SQUARE DROP-IN PAN &
SQUARE SS BULLET BURNER**
OPT-BP24SQDSSE12



**ROUND FLAT PAN &
TRIPLE 'S' SS BULLET BURNER**
OPT-BFP24RSSE12



**RECTANGULAR DROP-IN PAN &
'H' SS BULLET BURNER**
OPT-BP1260RDSSE12

! DANGER: FIRE OR EXPLOSION HAZARD

If you smell gas:

- » **Shut off gas to the appliance.**
- » **Extinguish any open flame.**
- » **If odor continues, leave the area immediately.**
- » **After leaving the area, call your gas supplier or fire department.**

Failure to follow these instructions could result in fire or explosion, which could cause property damage, personal injury, or death.

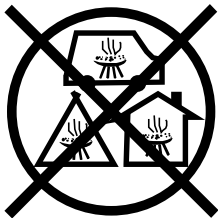

! DANGER: Carbon Monoxide Hazard

This appliance can produce carbon monoxide which has no odor. Using it in an enclosed space can kill you.

Never use this appliance in an enclosed space such as a camper, tent, car or home.

NATIONAL
FIREPLACE
INSTITUTE



Installation

We suggest that our products be installed by professionals that are locally licensed by the authority having jurisdiction in gas piping.

Service

We suggest that our products be serviced by a professional certified in the US by the National Fireplace Institute (NFI) as NFI Gas Specialists.



SECTION 1

WARNINGS

THIS SECTION OUTLINES WARNING ASSOCIATED WITH INSTALLATION, USE, AND OPERATION.



This is a Safety Alert Symbol

When you see this symbol on the fire pit insert, or in this manual, look for one of the following signal word panels alerting you to the potential for personal injury, death or major property damage.

 **WARNING: FOR OUTDOOR USE ONLY**

Installation and service must be performed by a qualified installer, service agency, or the gas supplier.

 **WARNING:** Do not store or use gasoline or other flammable vapors and liquids, In the vicinity of this or any other appliance.

An LP-Cylinder not connected for use shall not be stored in the vicinity of this or any other appliance.

For use with Natural or Propane gas only. NO SOLID FUELS TO BE USED WITH THIS SYSTEM.

 **WARNING:** If the information in this manual is not followed exactly, a fire or explosion may result causing property damage, personal injury, or loss of life.

 **DANGER - FIRE OR EXPLOSION HAZARD**

If you smell gas:

1. Shut off gas to appliance.
2. Extinguish any open flame.
3. If odor continues, leave the area immediately.
4. After leaving the area, call your gas supplier or Fire department.

Failure to follow these instructions could result in fire or explosion, which could cause property damage, personal injury, or death.

 **CALIFORNIA PROPOSITION 65 WARNING** 

This product can expose you to Carbon Monoxide, which is known to the state of California to cause cancer and birth defects or other reproductive harm. (For more information, go to: www.p65warnings.ca.gov)

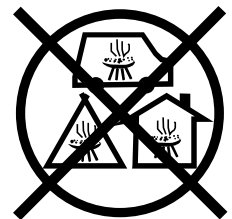

WARNINGS CONT'D.

THIS SECTION OUTLINES WARNING ASSOCIATED WITH INSTALLATION, USE, AND OPERATION.

▲ DANGER • FLAMMABLE GAS UNDER PRESSURE.
LEAKING LP-GAS MAY CAUSE A FIRE OR EXPLOSION IF IGNITED
CAUSING SERIOUS BODILY INJURY OR DEATH.
CONTACT LP GAS SUPPLIER FOR REPAIRS, OR DISPOSAL OF THIS
CYLINDER OR UNUSED LP-GAS.

▲ WARNING • FOR OUTDOOR USE ONLY.*
DO NOT USE OR STORE CYLINDER IN A BUILDING,
GARAGE OR ENCLOSED AREA.

▲ WARNING:

- Know the odor of LP-gas. If you hear, see or smell leaking LP-gas, immediately get everyone away from the cylinder and call the Fire Department. Do not attempt repairs.
- Caution your LP-gas supplier to:
 - Be certain cylinder is purged of trapped air prior to first filling.
 - Be certain not to over fill the cylinder.
 - Be certain cylinder requalification date is checked.
- LP-gas is heavier than air and may settle in low places while dissipating.
- Contact with the liquid contents of cylinder will cause freeze burns to the skin.
- Do not allow children to tamper or play with cylinder.
- When not connected for use, keep cylinder valve turned off. Self contained appliances shall be limited to a cylinder of 30 lb capacity or less.
- Do not use, store or transport cylinder where it would be exposed to high temperatures. Relief valve may open allowing a large amount of flammable gas to escape.
- When transporting, keep cylinder secured in an upright position with cylinder valve turned off.

WHEN CONNECTING FOR USE:

- Use only in compliance with applicable codes.
- Read and follow manufacturer's instructions.
- Consult manufacturer's instructions concerning the cylinder connection provided with your appliance.
- Be sure regulator vent is not pointing up.
- Turn off all valves on the appliance.
- Do not check for gas leaks with a match or open flame. Apply soapy water at areas marked "X". Open cylinder valve. If bubble appears, close valve and have LP-gas service person make needed repairs. Also, check appliance valves and connections to make sure they do not leak before lighting appliance.
- Light appliance(s) following manufacturer's instructions.
- When appliance is not in use, keep the cylinder valve closed.

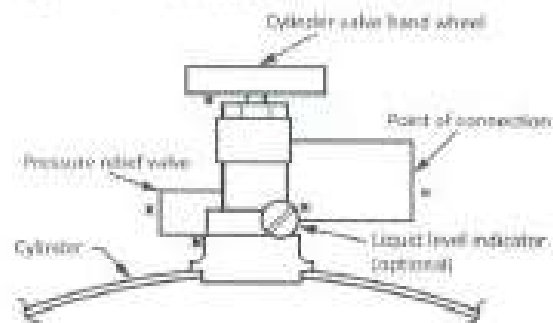

DO NOT REMOVE, DEFACE, OR OBLITERATE THIS LABEL
*** EXCEPT AS AUTHORIZED BY ANSI Z223.1 / NFPA 58**

▲ DANGER. Do not store a spare LP cylinder under or near a barbecue grill, or other heat sources. NEVER fill an LP cylinder beyond 80% full; a fire causing death or serious injury may occur.

IMPORTANT SAFETY INFORMATION

TECHNICAL SUPPORT, SYMBOL LEGEND, SAFETY INFORMATION FOR INSTALLERS & END-USERS.

Instructions are also available at theoutdoorplus.com, Please carefully follow the instructions in this manual to prevent personal injury or property loss. Instructions are updated as needed. It is the installer's responsibility to periodically review instruction for applicable updates.

The steps listed as:

WARNINGS: Contains information critical to the safe installation and operation of the fire pit.

WARRANTY REQUIREMENT: Must be strictly followed to qualify for product warranty. Warranty will be void if not followed.

IMPORTANT: Are notes and insights to help ensure product satisfaction and serviceability.

WARNINGS:

- It is the installer's responsibility to ensure a safe installation and to educate the end user as to proper operation. Leave this manual with the end user.
- Never alter product or configuration in any way.
- We suggest that our products be installed by professionals that are locally licensed by the authority having jurisdiction in gas piping. We suggest that our products be serviced annually by a professional certified in the US by the National Fireplace Institute (NFI) as NFI Gas Specialists or in Canada by WETT (Wood Energy Technical Training). Installer must follow all instructions carefully to ensure proper performance and safety.
- The Outdoor Plus Company, Inc. is not responsible for your actions.
- Product is not intended to be a starter for wood or any other combustibles.
- Only use gas/fuel type specified for this fire pit see label on the fire pit control Box.
- Verify correct gas/fuel type and pressure. Never use an alternative fuel to include bio-fuel, ethanol, lighter fluid or any other fuel.
- Gas pressure and type should be checked prior to use and installation.
- DO NOT USE this appliance if any part has been under water. Immediately call a qualified service technician to inspect the appliance and to replace any part of the control system and any gas control which has been under water.
- For the safety of yourself and others, ensure that the Transformer is plugged into a GFCI Outlet.

IT IS THE RESPONSIBILITY OF THE INSTALLER TO FOLLOW:

- The National Fuel Gas Code, ANSI Z223.1/NFPA 54 or International Fuel Gas Code.
- The National Electrical Code, ANSI/NFPA 70.
- Local Codes

SUPPLY PRESSURE MIN/MAX:

Natural Gas:

Supply Pressure:

Minimum: 3.5" W.C. .87 kPa

Nominal: 7" W.C. 1.74 kPa

Maximum: 14" W.C. 3.48 kPa

Liquid Propane Gas:

Supply Pressure:

Minimum: 8" W.C. 1.99 kPa

Nominal: 11" W.C. 2.73 kPa

Maximum: 14" W.C. 3.48 kPa

TABLE OF CONTENTS

DIRECTORY OF PAGES & SECTIONS



THE OUTDOOR PLUS

USA MANUFACTURER OF FIRE & WATER PRODUCTS

SECTION 1 WARNINGS	1
SECTION 2 IMPORTANT SAFETY INFORMATION	4
SECTION 3 COMPONENTS OVERVIEW	6
SECTION 4 OPERATION SEQUENCE	8
SECTION 5 SELECTING THE LOCATION	9
SECTION 6 ENCLOSURE CONSTRUCTION	10
SECTION 7 PRE-PLANNING CHECKLIST	12
SECTION 8 INSTALLATION INSTRUCTIONS	13
SECTION 9 FIRE MEDIA USAGE	19
SECTION 10 PARTS LIST	21
SECTION 11 OPERATION & USAGE	22
SECTION 12 TROUBLESHOOTING	25
SECTION 13 MAINTENANCE	28
SECTION 14 REPLACEMENT PARTS	30
SECTION 15 CLEARANCE FROM COMBUSTIBLES	31
SECTION 16 WARRANTY INFORMATION	34



COMPONENTS OVERVIEW

THIS SECTION OUTLINES THE FEATURES OF THE LOW VOLTAGE PANS & BURNERS

Installation must conform with local codes or, in the absence of local codes, with the National Fuel Gas Code, ANSI Z223.1 / NFPA 54, or International Fuel Gas Code.

The appliance when installed, must be electrically grounded in accordance with local codes, or in the absence of local codes, with the National Electrical Code, ANSI/NFPA 70; or the Canadian Electrical Code, CSA C22.1, if applicable.

When an appliance is for connection to a fixed piping system, the installation must conform with local codes, or in the absence of local codes with the National Fuel Gas Code, ANSI Z223.1 * NFPA 54; National Fuel Gas Code; Natural Gas and Propane Installation Code, CSA B149.1; or Propane Storage and Handling Code, CSA B149.2, as applicable.

COMPONENTS OVERVIEW

- » Certified to ANSI Z21.97-(2017) / CSA 2.41-(2017)
- » -20° to 175° temperature range.
- » Durable connections designed to resist outdoor conditions.
- » TC Flame-sense system.
- » Hot Surface Igniter (HSI).
- » LED diagnostics.

ELECTRONICS

- » Electronics are certified for CAN/CSA-E60730-1, ANSI Z21.20-2014, CAN/CSA-C22.22 No.60730-2-5-14, UL 60730-2-5 Edition 3, & UL 60730-1.
- » 12 or 14 VAC for installations within 5 feet of water.
- » Transformer to GFCI Outlet connection for safety.
- » Potted control module to protect against moisture and damage.
- » Hot Surface Ignition (HSI), provides stable burner ignition in harsh conditions.
- » Thermocouple Flame Sense, fast responding and resistant to wind, moisture and corrosion.
- » LED diagnostics for field service and troubleshooting.

GAS VALVE AND PILOT COMPONENTS

- » The manual key valve is CSA Certified to ANSI Z21.15/CSA9.1
- » The pilot is CSA Certified to ANSI Z21.20
- » Coils are encapsulated to protect against moisture.
- » Pilot has robust flame pattern, wind resistant.
- » Pilot injectors are stainless steel.
- » Thermocouple is nickel plated for durability.
- » Hot Surface Igniter (HSI) with protective cage.
- » Hot Surface Igniter (HSI) connection is waterproof.
- » The Power Wire connector is waterproof.

COMPONENTS OVERVIEW CONT'D.

THIS SECTION OUTLINES THE FEATURES OF THE LOW VOLTAGE PANS & BURNERS

GAS CONNECTION

Installation or repair should be performed by a qualified service technician who is locally licensed. The appliance should be inspected before use and at least annually by a qualified technician.

DO NOT remove any decal/rating plates from the Electronic Ignition Valve. A gas shut off must be installed outside the exterior of the fire feature for emergency shut off and maintenance. A sediment trap is highly recommended to alleviate any problems from debris or sediment in the gas line. It is the installers responsibility to ensure the fuel supply and line are adequate to supply the maximum BTU for the burner used.

Note: a heat shield/plate **MUST** be installed between the Electronic Ignition Valve and the burner ring to avoid over heating.

The Electronic Ignition Valve box is pre-mounted to the burner or burner & pan combination.

The Electronic Ignition Valve is designed to automatically close the gas valve and shut down should temperatures exceed 175° Fahrenheit. To keep the unit cool, proper ventilation and a heat shield must be provided.

The Outdoor Plus Recommends a Stainless Steel Whistle-Free Flex Hose to eliminate the noise.

PILOT ASSEMBLY CONNECTIONS

We pre-assemble the pilot on top of the burner pan and in that configuration, the pilot line, thermocouple and igniter lead should be lowered through a hole in the pan prior to connecting to the control box. The pilot comes pre-assembled from the factory, so the installer can simply connect the assembly to the main control box. The igniter has a “shaped” push on waterproof connector ensuring that it can only be connected the correct way. Push this black plastic connector parts firmly together until it locks in place. Gently tug on wires to assure connection is secure. The flexible corrugated pilot tube has a flare fitting that should be connected 1/4 turn past hand tight. Please double check to ensure the fitting is snug both into the control box and the flare connection. The thermocouple should now be connected. It screws onto the 11/32” brass fitting on the control box closest to the black connector. It should be snug, but do not over-tighten.

Next, you may mount the pilot to the burner pan. The shield is designed with perforated material which you can use to secure to the pan with self tapping screws. The installer can determine the best placement for the pilot depending on the burner configuration keeping the pilot within 1” from a burner port for quick ignition. Once all connections are complete, it is highly recommended to perform a leak test. Turn on the gas supply and using gas test solution or soapy water solution, spray the gas connections on the Electronic Ignition Valve including the pilot connector to ensure it is leak free.

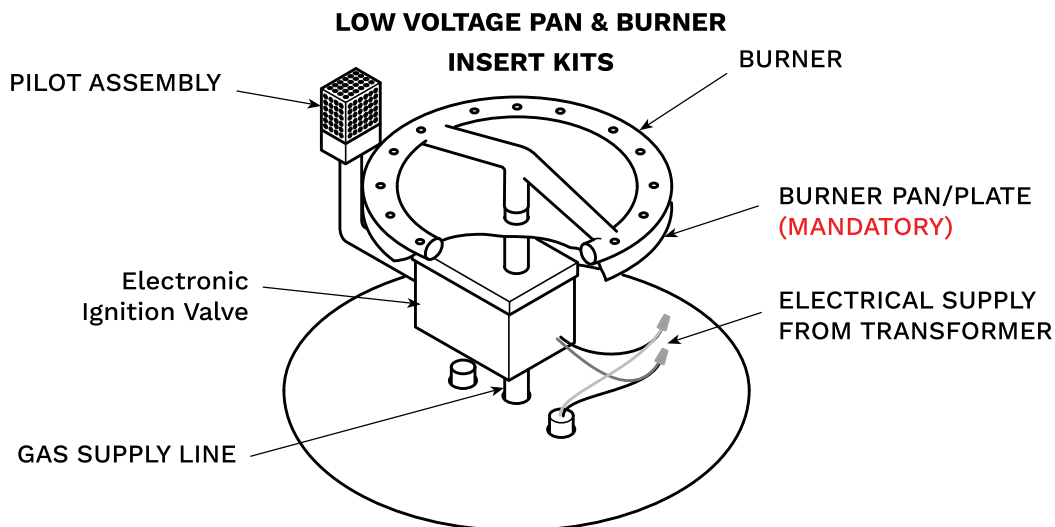

OPERATION SEQUENCE

THIS SECTION DEMONSTRATES THE OPERATION SEQUENCE OF OUR LOW VOLTAGE PANS & BURNERS.

Sequence of Operation

When powered, indicating a call for heat, the unit will wait for Pre-Purge time. The HSI will be energized for warm up time, then the pilot gas valve will energize for Trial-for-Ignition time. The HSI will turn off after Ignition Time. If the flame is detected on the thermocouple before the end of the trial for ignition time, the HSI will turn off. The main valve will turn on and the pilot valve will remain on until power is removed or flame signal is lost. If flame is lost, the control will turn off the gas valve, and after the flame loss recycle delay, restart

the ignition sequence. If a flame is not detected during the Trial-for-Ignition time and Trials-for-Ignition remain, the pilot and HSI will turn off and wait for Inter-Purge time before starting the next ignition attempt. If a flame is detected prior to turning on the gas valve, the control will stop sequence and remain in safety shutdown until the flame signal is below minimum threshold, or drops continuously by minimum threshold value before continuing.

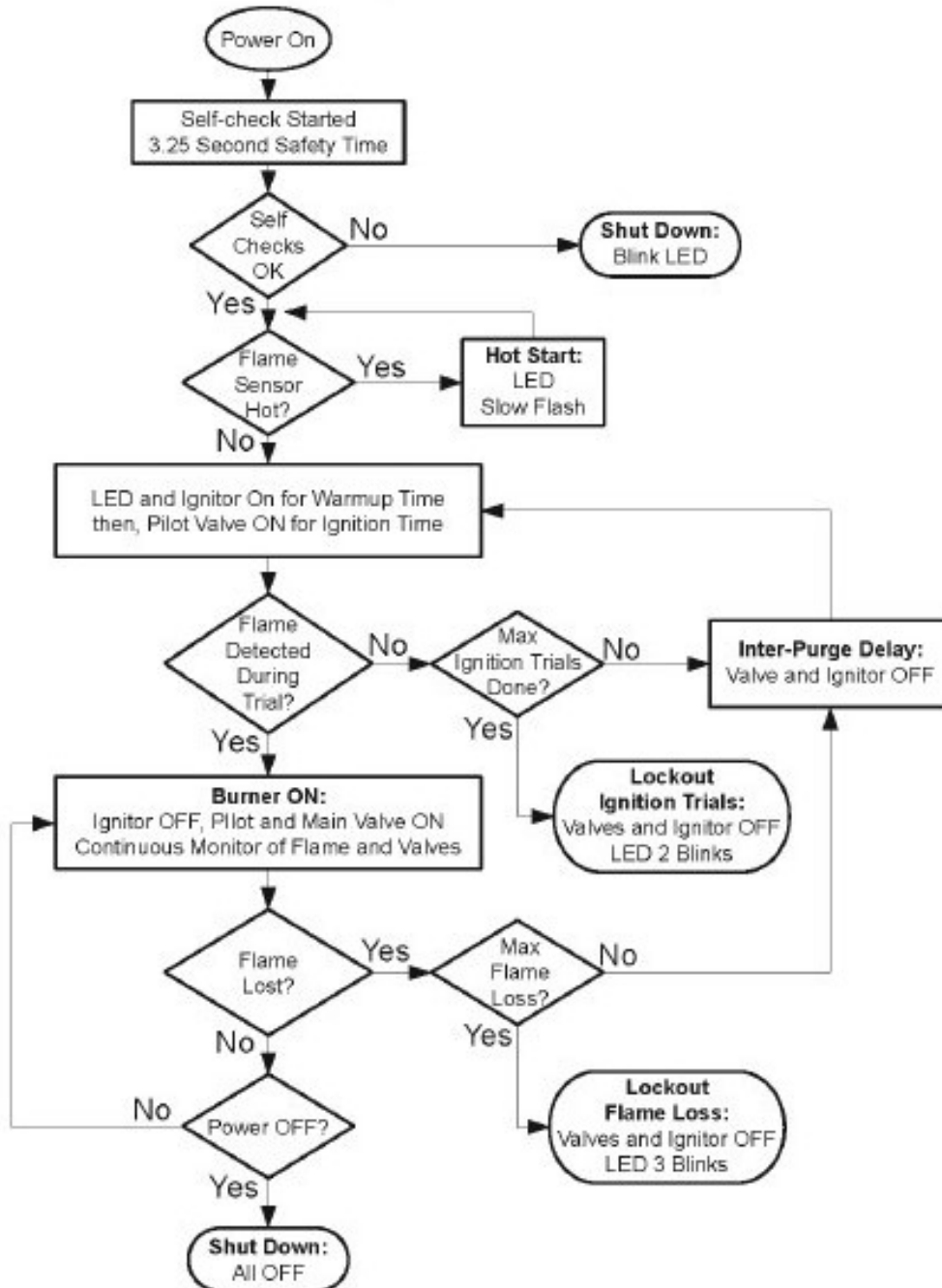

SELECTING THE LOCATION

⚠️ WARNINGS:

- All fire pits, match lit kits, spark ignition, safety pilot and Electronic Ignition Components are designed and intended for outdoor use only.
- All fire pits must have a gas shutoff on the outside of the exterior of the fire pit to allow for emergency shut off and maintenance. **DO NOT PLACE ON TOP OF NON-COMBUSTIBLE FLOORING.**
- Select a location where the fire pit can be attended during operation. Never leave an operating fire pit unattended or by someone not familiar with its operation or emergency shut off locations.
- Both children and adults should be alerted to the hazards of high surface temperatures and should stay away to avoid burns and clothing ignition.
- Young children should be carefully supervised when they are in the area of fire pit.
- Clothing or other flammable materials should not be placed on or near fire pit.
- Fire pits create very high temperatures - Combustibles must be located far enough away that there is no risk of ignition.

⚠️ IMPORTANT:

- It is recommended that material such as granite, marble or other dense stone be kept away from heat and especially flame due to risk of cracking. Manufacturer is not responsible for damage.

CLEARANCE FROM COMBUSTIBLES | UP TO 65K BTUS | SEE SECTION 15

Under Valve Box When Applicable	2" For Drainage
Sides Surrounding Fire Pit	36" From Structure or Combustibles
Overhead Clearance	Min. 84" Overhead Clearance

CLEARANCE FROM COMBUSTIBLES | 66K TO 200K BTUS | SEE SECTION 15

Under Valve Box When Applicable	2" For Drainage
Sides Surrounding Fire Pit	48" From Structure or Combustibles
Overhead Clearance	NO OVERHEAD CONSTRUCTION

CLEARANCE FROM COMBUSTIBLES | 201K TO 400K BTUS | SEE SECTION 15

Under Valve Box When Applicable	2" For Drainage
Sides Surrounding Fire Pit	48" From Structure or Combustibles
Overhead Clearance	NO OVERHEAD CONSTRUCTION

- Select a location with proper drainage.
- Choose a location that allows easy access for installation and maintenance of the fire pit.
- Pick a location that allows sufficient horizontal room to enjoy the fire pit while allowing a safe distance from the heat and flame.

⚠️ WARNING: Venting is required to dissipate heat and any residual fuel. Failure to provide proper ventilation could result in overheating and or explosion. See **Proper Venting** topic in the **Enclosure Construction** Section.

ENCLOSURE CONSTRUCTION

THIS SECTION OUTLINES THE CONSTRUCTION OF THE FIRE FEATURE ENCLOSURE REQUIREMENTS & WARNINGS

WARNINGS:

- All fire pits must have a gas shutoff on the outside of the exterior of the fire pit to allow for emergency shut off and maintenance.
- Always use proper materials and construction for gas supply, power and enclosure.
- The interior void space of the enclosure surrounding the valve box cannot be filled with any material (gravel, crushed rock, concrete, etc.)- It is a requirement to have a minimum of 2” under the valve box for proper ventilation and drainage.
- Select materials that are non-combustible in both initial installations as well as over time.
- The fire pit assembly should be recessed a minimum of 2.25” from the top of the enclosure to protect flame from being blown out. Some areas may require more- 4 to 6” is not uncommon.

WARRANTY REQUIREMENT:

- The enclosure must be constructed on a stable surface. The weight of the fire pit must be supported by the pan and not by any control/valve box. For Electronic Ignition Components the control/valve box must be above grade with adequate drainage to prevent water damage to the controls inside the box.

IMPORTANT:

- Make sure that the structure is level. We recommend the use of the installation collar (optional) that may be mortared into the surround.
- The Outdoor Plus recommends that the pan lip is recessed on trough (linear). The Outdoor Plus cannot guarantee the lip on all of our products will be perfectly flat and will not warp due to heat.
- Product must be accessible for service.

PROPER VENTING

- Certain fire pit enclosures may require extra ventilation depending on size, material or extended use.
- 1 Square Inch of ventilation is REQUIRED for every 25,000 BTUs.
- This is especially important for propane units, as propane gas is heavier than air and can pool in the bottom of an enclosure.

 **WARNING:** Venting is required to dissipate heat and any residual fuel. Failure to provide proper ventilation could result in overheating and or explosion.

ENCLOSURE CONSTRUCTION

THIS SECTION OUTLINES THE CONSTRUCTION OF THE FIRE FEATURE ENCLOSURE REQUIREMENTS & WARNINGS

ENCLOSURE CONSTRUCTION FOR SELF-CONTAINED PROPANE GAS SUPPLY SYSTEMS

An enclosure for a propane gas cylinder shall be ventilated by openings at both the upper and lower levels of the enclosure. This shall be accompanied by one of the following:

- one side of the enclosure shall be completely open; or
- for an enclosure having four sides, a top, and a bottom:
 1. at least two ventilation openings shall be provided in the sidewalls of the enclosure, located within 5 in (217 mm) of the top of the enclosure, equally sized, spaced at a minimum of 90 degrees (1.57 rad), and unobstructed. The opening(s) shall have a total free area of not less than 1 in²lb (14.2 cm²kg) of stored fuel capacity;
 2. ventilation opening(s) shall be provided at floor level of the enclosure and shall have a total free area of not less than ½ in²•lb (7.1 cm²• kg) of stored fuel capacity. If ventilation openings at floor level are in a sidewall, there shall be at least two openings. The bottom of the openings shall be 1 in (25.4 mm) or less from the floor level and the upper edge no more than 5 in (127 mm) above the floor level. The openings shall be equally sized, spaced at a minimum of 90 degrees (1.57 rad), and unobstructed;
 3. every opening shall have minimum dimensions so as to permit the entrance of a 1/8 in (3.2 mm) diameter rod;
 4. ventilation openings in sidewalls shall not communicate directly with other enclosures of the appliance.

The cylinder valve shall be readily accessible for hand operation. A door on the enclosure to gain access to the cylinder valves is acceptable, provided it is non-locking, and can be opened without the use of tools. Designs using a cover to gain access to the cylinder and cylinder valve shall be provided with handles or equivalent at a minimum of 180 degrees apart to facilitate lifting of the cover.

The enclosure for the propane gas cylinder shall isolate the cylinder from the burner compartment to provide:

- shielding from radiation;
- a flame barrier; and
- protection from foreign material.

There shall be a minimum clearance of 2 in (50.8 mm) between the floor of the non-disposable propane gas cylinder enclosure and the ground.

The design of the appliance shall be such that:

- a non-disposable propane gas cylinder can be connected, disconnected, and the connections
- inspected and tested outside the cylinder enclosure; and
- connections, which could be disturbed when installing the cylinder in the enclosure, can be leak tested inside the enclosure.

PRE-PLANNING CHECKLIST

THIS SECTION DEMONSTRATES THE PROPER INSTALLATION AND TESTING OF THE Low Voltage Pans & Burners.

TO ENSURE PROPER INSTALLATION PLEASE USE THIS PRE-PLANNING CHECKLIST:

- Recommended Tools:
 - General Plumbing Tools (Pipe Wrench, Crescent Wrench, Pipe Cutters, etc.)
 - Manometer (To test static & dynamic gas pressure)
 - Voltmeter (To check voltage & amperage to unit)
 - Gloves
 - Mini-Butane Torch
 - Cordless Drill
 - Dielectric Grease or Silicone (For waterproofing wire nuts)
 - Whistle-free Stainless Steel Flex Gas Hoses (TOP does not recommend using the standard yellow corrugated flex gas hoses as those cause a loud persistent whistle sound to occur when using the fire feature)
- Ensure the location is free of combustibles (See section 11 for more information.)
- Measure & record distances of gas piping & electrical conduit runs, these will be useful for calculating gas pressure and proper wiring. The distance and wire gauge DIRECTLY affects the performance of the Electronic Ignition Component.
- The Fire Feature is delivered on a pallet via freight and placed in front of your home. Please have a team of movers ready to help move the unit from the curbside/driveway to the desired location. ALWAYS inspect the pallet for damage or missing pieces, if there is damage or missing pieces please DO NOT sign for the pallet and call our support team immediately to help resolve any problems.
- All fire features require a hollow area underneath the pan for serviceability of the unit, DO NOT FILL the hollow basin with sand or any other media.
- Gas Risers should come up to a maximum height of 2” from the ground and use a 90-degree fitting to help reduce the basin height and allow for easy servicing.
- TOP DOES NOT RECOMMEND to use the standard yellow corrugated gas flex hoses with its fire features, TOP recommends to use a Whistle-Free Stainless Steel Gas Flex Hose in order to help eliminate any whistling sounds.
- Ensure you use the Home-run method for connecting multiple Electronic Ignition Component units, DO NOT DAISY CHAIN these units.
- Ensure you ordered the right gas type and ignition type for your installation.

INSTALLATION INSTRUCTIONS

THIS SECTION DEMONSTRATES THE PROPER INSTALLATION AND TESTING OF THE Low Voltage Pans & Burners.

STEP 1 | SELECTING A LOCATION

- Please **see Section 5** on Selecting a location for instructions.

STEP 2 | VENTILATION & ENCLOSURE CONSTRUCTION

- Please **see Sections 6 & 10** on ventilation & enclosure construction instructions.
- Confirm mounting brackets are used with bowls (mortared bowls will prevent proper venting and will cause electronics to prematurely quit working).
- Ensure lava rock media is not overfilled and do NOT cover the pilot for electronic systems.

STEP 3 | GAS CONNECTION

- Please **see Section 3** for warnings.
- Place a ball valve close to the gas piping coming from the building for safety purposes.
- Gas Flow Pressure Requirements | **See Figure 1**
 - Please reference figure 1 on the next page – We are looking for 7” (Natural Gas) or 11” (Propane) Dynamic for optimum flow.
 - Check dynamic & static gas flow pressure before the Electronic Valve Box with supplied “T”. **See Figure 2** for a visual reference. ***Note: “T” Only Available with Bowls, for all other units please test static & dynamic gas pressure from gas riser.**
 - “T” goes in between the gas riser and the electronic valve box. Use the provided hoses to connect, ensure all gas fittings are tightly secured to prevent to gas leakage.
- If the unit has a manifold please **See Figure 6**, allow space in your design for at minimum 10 inch height basin for the manifold.
- **For appliances for use with a fixed fuel piping system and equipped with an appliance gas pressure regulator, the appliance and its individual shutoff valve must be disconnected from the gas supply piping system during any pressure testing of the system at test pressures in excess of ½ psi (3.5kPa)**
- **The appliance must be isolated from the gas supply piping system by closing its individual manual shutoff valve(s) during any pressure testing of the gas supply piping system at the pressures equal to or less that ½ psi (3.5 kPa)**

STEP 4 | IGNITION OPTIONS

- There are numerous options available to turn on/off your fire feature, you may hard wire the provided transformer to a UL certified light switch, pool controller, smart home hub, wireless remote light switch, etc.
- Please **See Figure 4** for a visual reference on the ignition options.

STEP 5 | ELECTRICAL CONNECTION & TESTING

- Place the transformer closer to the fire features (at minimum 5ft away from water & 1ft above ground on a wall). **DO NOT CONNECT 110V DIRECTLY TO THE LOW VOLTAGE VALVE BOX.**
- Check for incoming (110V) and outgoing voltage (14V) (confirm wire to 14V lead, typically blue wire is 14V / **See Page 16 for Transformer Chart & Guidelines.**)
- Confirm that appropriate wire gauge is being used, if larger gauge wire is recommended to be

INSTALLATION INSTRUCTIONS CONT'D.

THIS SECTION DEMONSTRATES THE PROPER INSTALLATION AND TESTING OF THE Low Voltage Pans & Burners.

used, test first with your supplied transformer (**See Figure 3**)

- Confirm that a 300W transformer is being used, the provided transformer can power up to 4 Low Voltage Pans & Burners units.
- The Low Voltage Pans & Burners has a red and a black wire protruding from it. These are the power wires. When multiple Low Voltage Pans & Burners Systems are connected, the polarity between them must be the same. To achieve this, all of the red wires must be connected to the same wire from the transformer and all of the black wires connected to the other wire from the transformer.
- Confirm that appropriate voltage and amps (minimum amperage required 2.0-2.2 amps)
- The Transformer must be connected to a GFCI Outlet for safety.

STEP 6 | APPLYING FIRE MEDIA

- Please **see Section 8** on Fire Media Usage
- **WARNING:** TOP **does NOT** recommend you use media on propane fire features, Liquid Propane is heavier than Natural Gas and can pool up in the burn area and potentially cause a backfire.

STEP 7 | OPERATION INSTRUCTIONS

- Please **see Section 9** on Operation Instructions, this section outlines how to operate your Low Voltage Pans & Burners fire feature.

Figure 1

GAS PRESSURE REQUIREMENTS		
Pressure	Natural Gas	Propane Gas
Minimum	3.5" W.C. / .87 kPa	8" W.C. / 1.99 kPa
Nominal	7" W.C. / 1.74 kPa	8" W.C. / 2.73 kPa
Maximum	14" W.C. / 3.48 kPa	8" W.C. / 3.48 kPa

Figure 2



Figure 3

120 VAC Primary Input - 300 W Output

Distance* Feet	2#6AWG	2#8AWG	2#10AWG	2#12AWG
5 ft.	12 VAC	12 VAC	12 VAC	12 VAC
10 ft.	12 VAC	12 VAC	12 VAC	13 VAC
20 ft.	12 VAC	12 VAC	13 VAC	13 VAC
30 ft.	12 VAC	13 VAC	13 VAC	14 VAC
40 ft.	13 VAC	13 VAC	14 VAC	
50 ft.	13 VAC	13 VAC	14 VAC	
60 ft.	13 VAC	14 VAC		
70 ft.	13 VAC	14 VAC		
80 ft.	13 VAC	14 VAC		
90 ft.	14 VAC			
100 ft.	14 VAC			
110 ft.	14 VAC			

* Length of run to light from transformer.

INSTALLATION INSTRUCTIONS CONT'D.

THIS SECTION DEMONSTRATES THE PROPER INSTALLATION AND TESTING OF THE Low Voltage Pans & Burners.

Figure 4

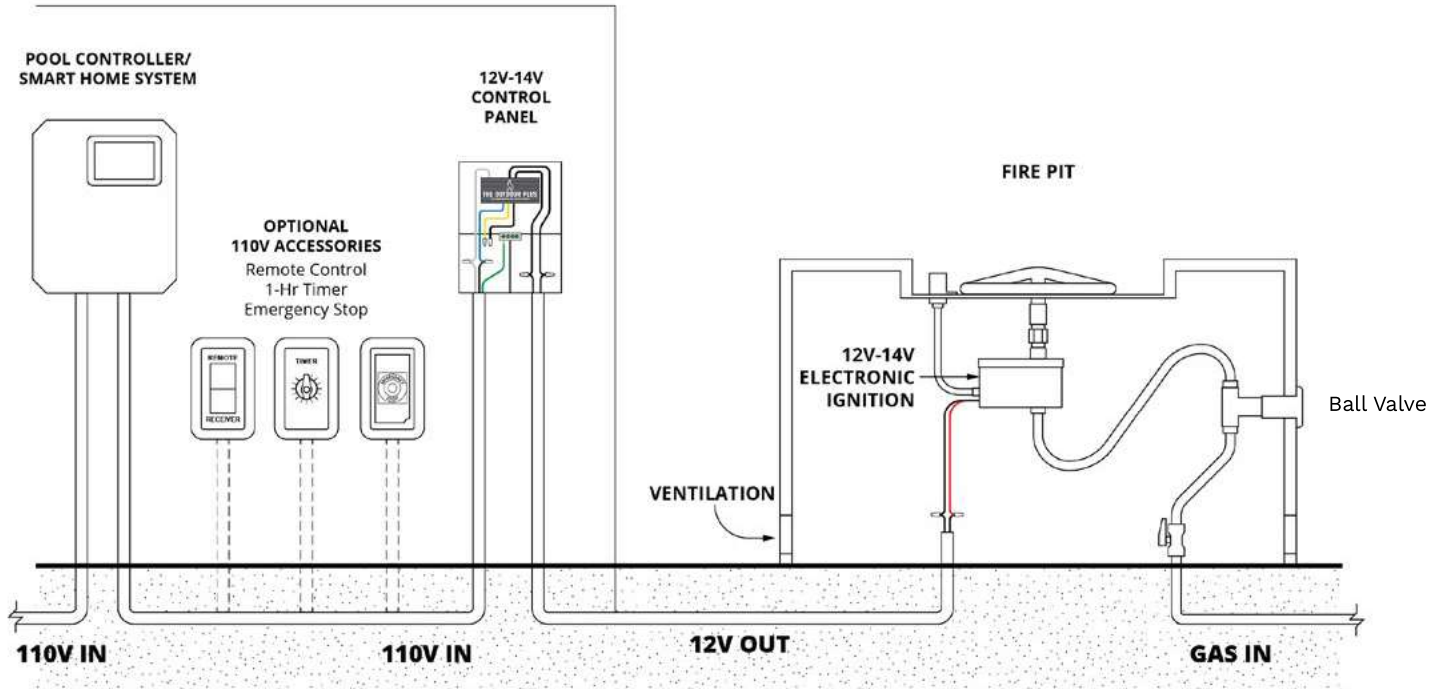

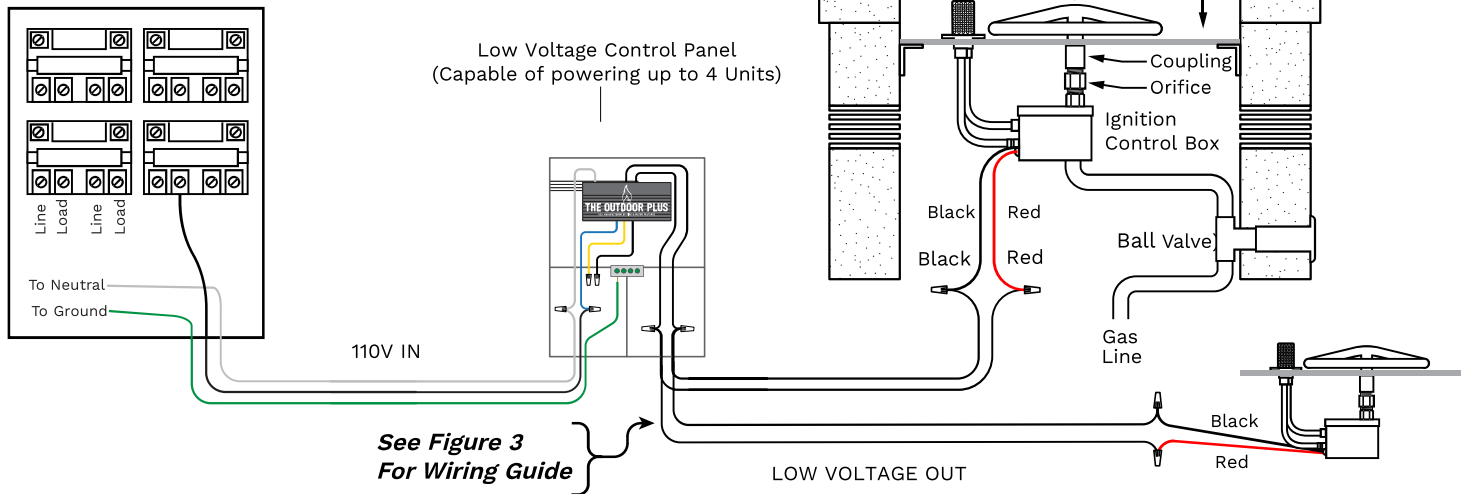

Figure 5

AUTOMATED POOL CONTROLLER
Aqualink, Pentair, Intellitouch

 Air Mixer for Propane Is Recommended for Propane Burners. See Instructions included with the appliance

 Minimum 18 in. of Cross Ventilation on Each Side of the Enclosure



INSTALLATION INSTRUCTIONS CONT'D.

THIS SECTION DEMONSTRATES THE PROPER INSTALLATION AND TESTING OF THE Low Voltage Pans & Burners.

Figure 6
Manifold Connection

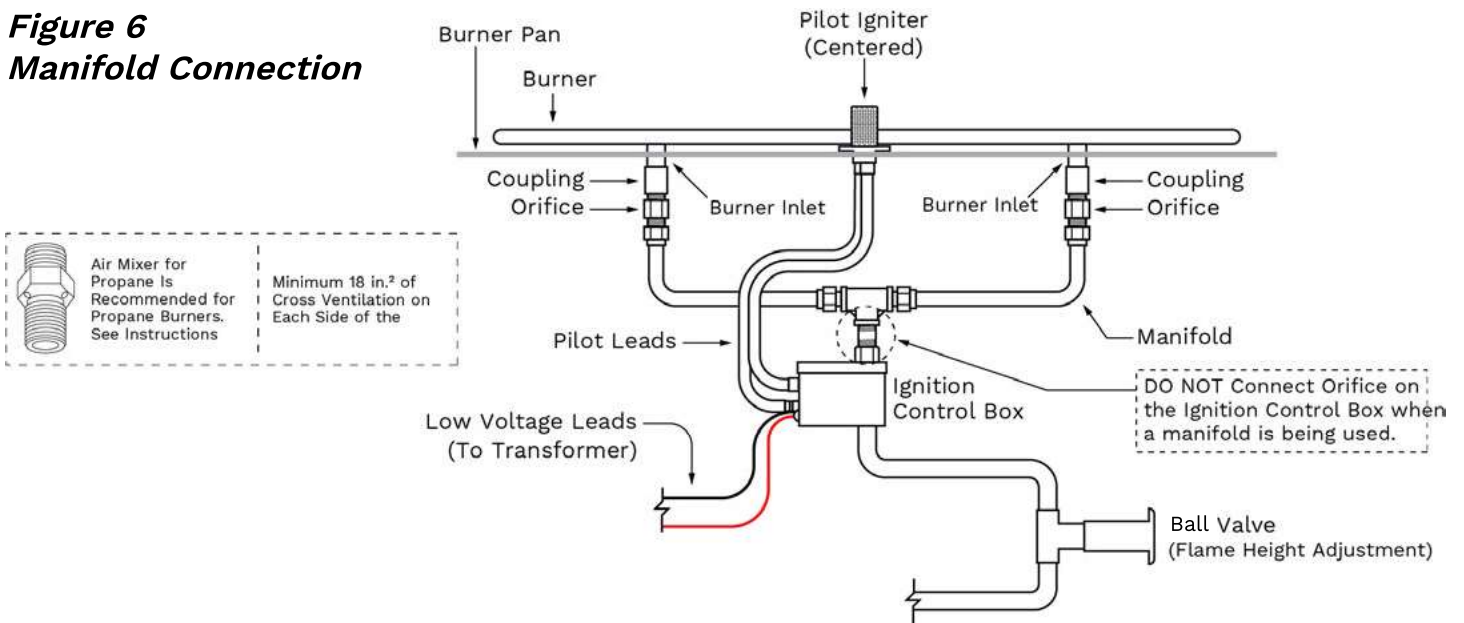

■ **WARNING: Failure to position the parts in accordance with these diagrams or failure to use only parts specifically approved with this appliance may result in property damage or personal injury.**

For Propane Installations (See below & continued on next page):

1. Cross ventilation is REQUIRED! A minimum of 1 square inch of ventilation is required for every 25,000 BTUs on each side of the installation. Air flow is your friend!
2. Propane Tank must be placed in/on a propane tank retainer/non-tip base to ensure the propane tank will not tip over.
3. NOTE: Propane cylinder NOT included. Make sure to properly locate the gas hose including locating the hose out of pathways where people may trip over it or in areas where the hose may be subject to accidental damage.

INSTALLATION INSTRUCTIONS CONT'D.

THIS SECTION DEMONSTRATES THE PROPER INSTALLATION AND TESTING OF THE Plug & Play to Low Voltage Pans & Burners

NOTE: Propane cylinder NOT included. Make sure to properly locate the gas hose including locating the hose out of pathways where people may trip over it or in areas where the hose may be subject to accidental damage.

<p>LEGEND</p> <p>— Hot / 110V</p> <p>— Ground</p> <p>— Neutral</p>	 <p>Air Mixer for Propane Is Recommended for Propane Burners. See Instructions included with the appliance</p>	<p>1 square inch of ventilation required for every 25,000 BTUs</p>
---	---	--

Figure 7

If you are using a remote propane gas supply system please see the following two diagrams. For internal storage the construction of the enclosure should comply with all ventilation and non-combustible enclosure requirements. See section 8 on page 11 for more details.

*Propane tank & LP enclosure are not supplied. Please see SECTION 6 - Enclosure Construction

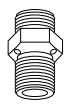
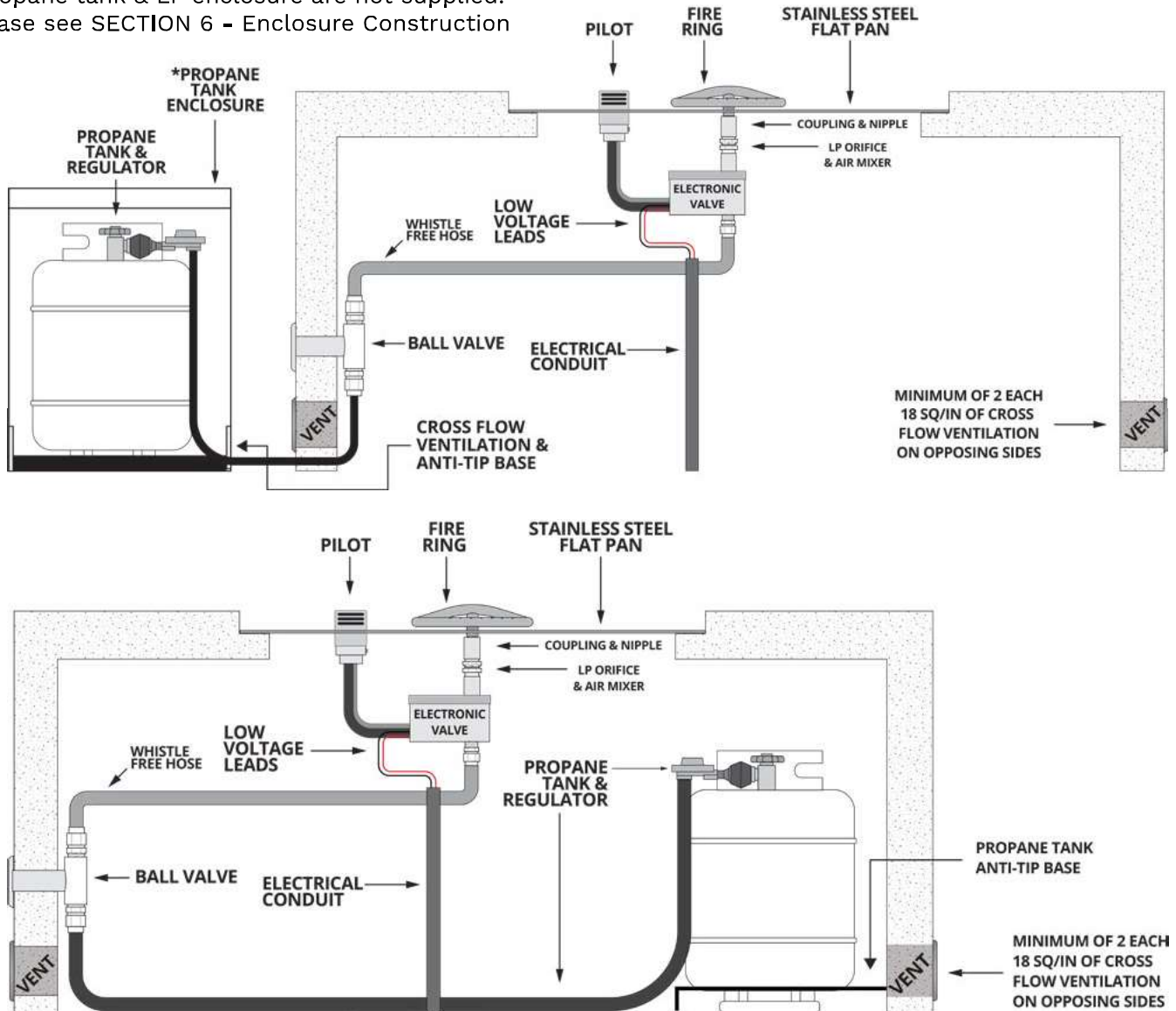

SECTION 8

INSTALLATION INSTRUCTIONS CONT'D.

THIS SECTION DEMONSTRATES THE PROPER INSTALLATION AND TESTING OF THE Low Voltage Pans & Burners.

WARNING - Risk of Fire or Electrical Shock

- Do NOT submerge transformer
- Do NOT connect two or more transformers in parallel
- Do NOT use with dimmers'
- This transformer must be installed according to the National Electrical Code (NEC) and local code requirements (For US installations article 680 and for Canadian installations, section 68 of the CEC). Important: This installation must be installed by a qualified electrician and is subject to approval by the local inspection authority
- Use copper conductors only
- Do NOT exceed the maximum ratings of individual components, wiring devices and current carrying capacity of conductors.
- Do NOT install this equipment within 5 feet (3 meters) reach paths of water.
- May be used with certified no-niche submersible luminaires or equivalent.
- Not for use with self-contained spas or hot tubs.
- For Canadian installations, supply circuit must be protected by a ground fault circuit interrupter.

MOUNT AT LEAST 1FT. (30 cm) ABOVE GROUND, WITH ARROWS UP

GENERAL INFO

These Safety Transformers are specifically designed to supply 12 volts to pool/spa lights, submersible fixtures and outdoor garden lights. The built-in circuit protection will disconnect power to the transformer in case of defect or overload. These transformers are suitable for direct connection to underwater Pool and Spa lights.

Enclosure Size: 7.25" High x 5.25" Wide x 4.5" Deep
Mounting Brackets on Top and Bottom

Knockouts: Total of Ten 0.5"-0.75" Combination
(4) bottom, (2) right, (2) Left, (2) Back

Model	Input 60 Hz.	Secondary Output	
		Lamp Watts(W)*	Voltage (VAC)
100W	120VAC	300 Max.	12, 13 or 14

Output	120v Input Multi-tap Primary Connection
12V	Black to 12V / White to Neutral
13V	Yellow to 13V / White to Neutral
14V	Blue to 14V / White to Neutral

Note: PX100 is for single bowls & PX300 is for multiple bowls

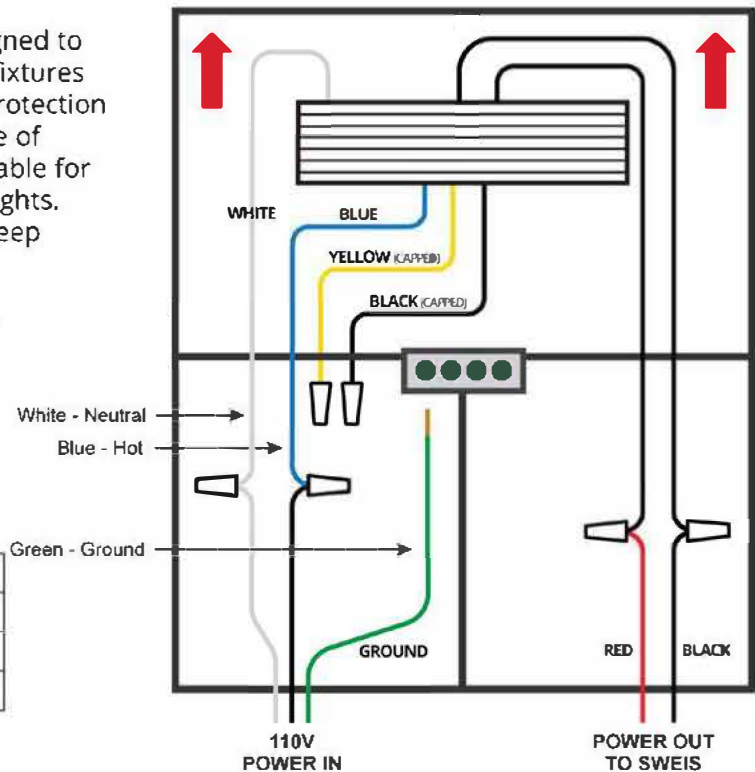

INSTALLATION

For field wiring information, please refer to the instructions attached to inside of front cover.

- Make sure that all unused taps (leads) are separately insulated.
 - Use the following tables as a guide to determine the correct wire size.
 - The voltage at lamp terminals after installation should be 12 ± 0.3 VAC.
 - Voltages above 12.3 VAC at the light may cause the internal safety fuse of the transformer to switch off and on. To prevent this from happening follow chart below for correct voltage and wire gauge selection.
1. Select power source by combining Bulb wattage.
 2. Determine length of cable run(s).
 3. Determine wire gauge needed to deliver necessary power.
 4. Connect cable to output tap of transformer given in table.

Note: The Transformer must be connected to a GFCI Outlet for safety.

120 VAC Primary Input - 100 W Output

Distance	6 Gauge	8 Gauge	10 Gauge	12 Gauge
10 ft.	12 VAC	12 VAC	12 VAC	13 VAC
20 ft.	12 VAC	12 VAC	13 VAC	13 VAC
30 ft.	12 VAC	13 VAC	13 VAC	14 VAC
40 ft.	13 VAC	13 VAC	14 VAC	
50 ft.	13 VAC	13 VAC	14 VAC	
60 ft.	13 VAC	14 VAC		
70 ft.	13 VAC	14 VAC		
80 ft.	13 VAC	14 VAC		
90 ft.+	14 VAC			

ENSURE ALL UNUSED LEADS ARE INSULATED (CAPPED)

FIRE MEDIA USAGE

THIS SECTION DEMONSTRATES HOW FIRE MEDIA SHOULD BE INSTALLED & WARNINGS

! WARNING: Do not use any other material as media in the fire feature other than: Lava rock no smaller than 1/2” average diameter.

- » DO NOT USE FIRE GLASS
- » DO NOT USE: Stones of man made materials
- » DO NOT USE: SAND, DO NOT FILL HOLLOW AREAS.
- » **DO NOT USE ANY FIRE MEDIA FOR PROPANE APPLICATIONS**

Media used in the fire feature enhances the look of the flame and improves the fire pit performance. As gas is emitted from the burner, the media helps mix air with fuel resulting in a more uniform flame and a cleaner burn. The media will also help spread the flame across all areas of the burner resulting in faster and more even ignition.

The media covering the burner should never exceed 2”. With all media, the pilot burner **MUST** be left open to the air for proper ignition. When the media is placed correctly, you should see the top of the pilot burner shield. If ignition is delayed or inconsistent, you may need to remove some media from the pilot burner area. When using propane gas it is important to check for back pressure created by excessive use of media that could result in gas being forced back through the air mixer.

! WARNING: If the information in this manual is not followed exactly, a fire or explosion may result causing property damage, personal injury, or loss of life.

! WARNING: Placement of media (lava, stone, etc.) **MUST NOT** cover the pilot assembly. **DO NOT USE SAND OR SMALL MEDIA!**

**DO NOT COVER PILOTS WITH SAND!
USE ONLY PROVIDED MEDIA**

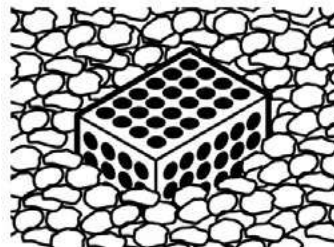

Pilot - Correct Installation

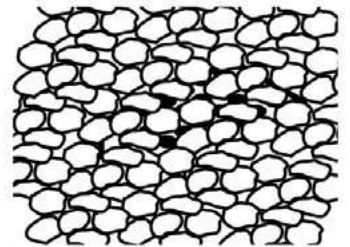

Pilot - Incorrect Installation

FIRE MEDIA USAGE

THIS SECTION DEMONSTRATES HOW FIRE MEDIA SHOULD BE INSTALLED & WARNINGS

MUST READ! BURNING MEDIA INSTALLATION



CORRECT INSTALLATION

- » ONLY FIRE-RATED MEDIA
- » PAN TO HOLD MEDIA
- » PROPER VENTING & CAVITY

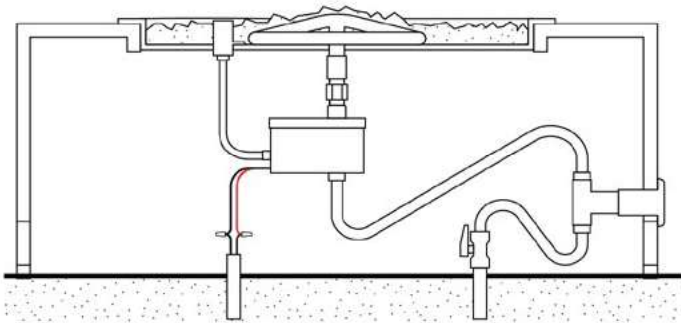
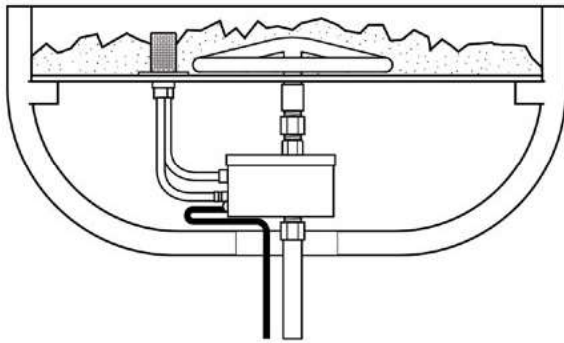

WRONG INSTALLATION

- » NO PAN TO HOLD MEDIA
- » IMPROPER VENTING
- » COVERS PILOT IGNITER

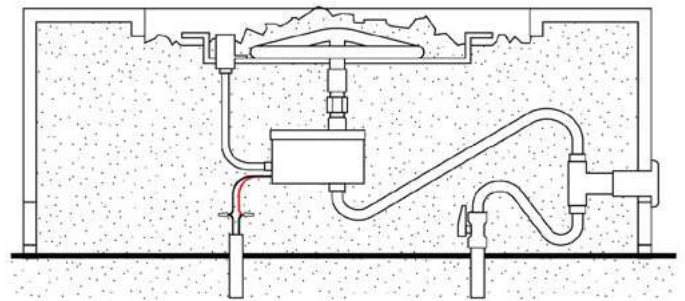
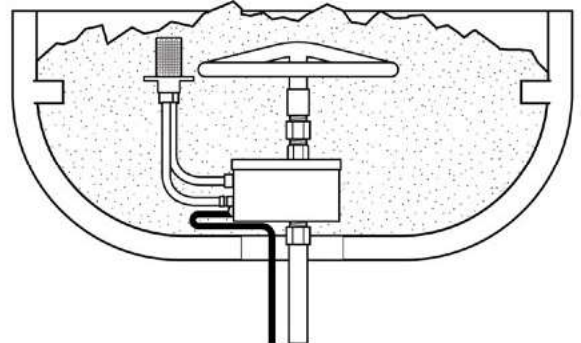

■ **WARNING:** Failure to position the parts in accordance with these diagrams or failure to use only parts specifically approved with this appliance may result in property damage or personal injury.

PARTS LIST

THIS SECTION OUTLINES THE LIST OF REPLACEABLE PARTS

FLAT FIRE PAN

- Hidden Pan
- Great for Natural Stone
- Custom Sizing Available

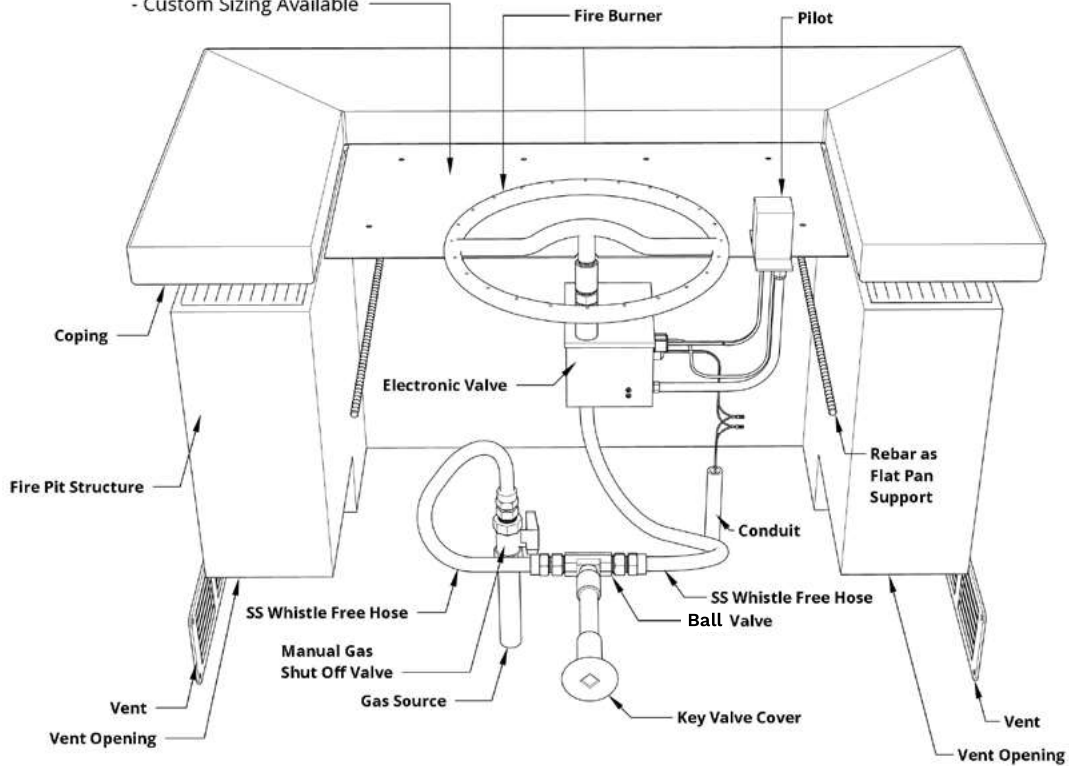

DROP-IN FIRE PAN

- Built in Support / 1" Flange
- Great for Flat Surfaces
- Custom Sizing Available

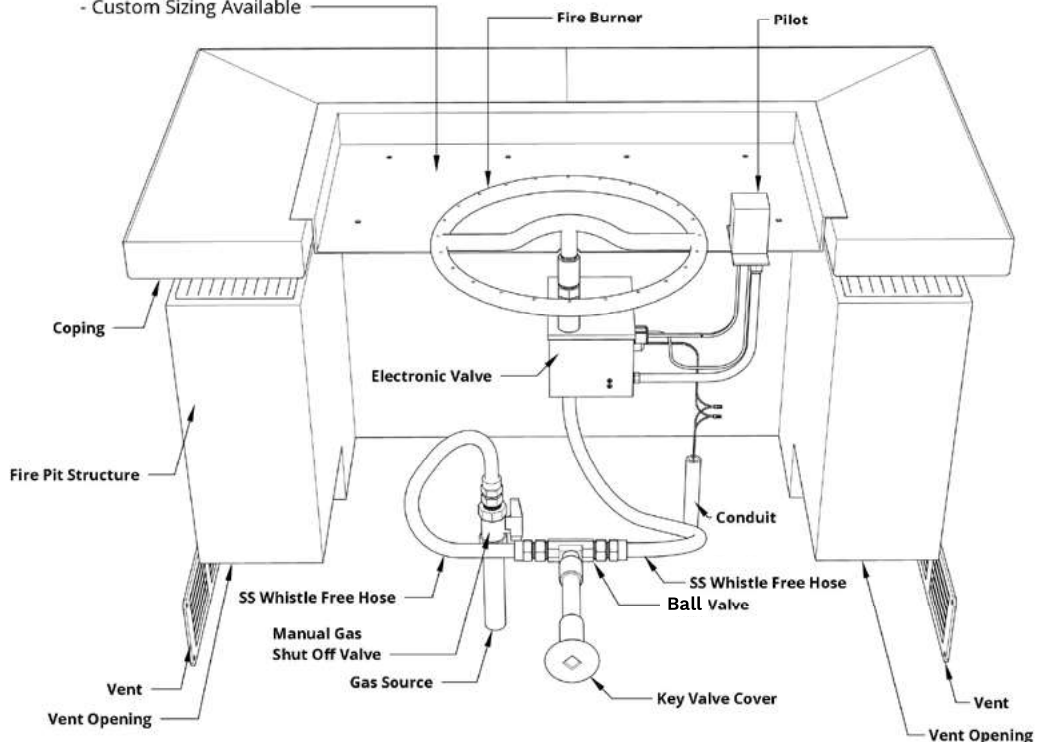

OPERATION & USAGE

THIS SECTION EXPLAINS HOW TO OPERATE THE FIRE FEATURE.

Congratulations on getting your new fire feature installed! Let's get started with how to operate and use your new Low Voltage Pans & Burners fire feature!

Your fire feature should have one of the following methods to turn on and off the fire feature:

Light Switch

- Simply flick the light switch to turn on or off the fire feature, you may leave the key valve in the open position since the electronic valve automatically opens and closes to allow gas flow.

Dial Timer

- Turn the dial timer knob clockwise to the desired run time and the feature will turn on.
- To shut off the fire feature turn the dial counter-clockwise to the off position.

Pool Controller

- Our Low Voltage Pans & Burners fire features work with many of the top brands and models of pool controllers, please reference your pool controller manual for operation of fire features.
- You may have multiple fire features turn on with a single button when utilizing the provided low voltage transformer or have dedicated button for each fire feature if you purchase multiple transformers for the low voltage electronic fire features.

Smart Hub/Home Automation

- Our Low Voltage Pans & Burners fire features work with many of the top brands and models of Smart Hubs and Home Automation systems, please reference your smart hub/home automation manual(s) for operation of fire features.
- You may have multiple fire features turn on with a single button when utilizing the provided low voltage transformer or have dedicated button for each fire feature if you purchase multiple transformers for the low voltage electronic fire features.

OPERATION & USAGE CONT'D

THIS SECTION EXPLAINS HOW TO OPERATE THE FIRE FEATURE.

Starting Up Your Electronic Ignition Component

- Startup: A few “On/Off” Cycles may be required in order to properly air within the gas lines after installation. The Fire Pit will lockout after 10 attempts to light the pilot - If this happens, power OFF then ON to restart.

Sequence of Operations

1. The hot wire igniter will glow red (meaning that it is powered) for 5 seconds before the pilot valve opens
2. The hot wire igniter will only become powered for the initial 15 seconds of the 60-second pilot cycle. This sequence repeats up to 10 times (approx. 15 minutes) before going into lockout
3. Pilot flame will ignite and warm the thermocouple, taking approximately 30 seconds to get hot. If it is not hot within 60 seconds, the system will shut down and you will restart from Step 1.
4. Once the thermocouple is hot, the main valve will open & allow the burner to ignite.
5. If the pilot flame is blown out at any point, the Electronic Ignition Components will shut down and will restart from Step 1

IMPORTANT

- If power to the fire pit is turned off & immediately turned back on, the system will go into lockout mode. To reset, turn off, wait 5 minutes, then turn on.
 - To Reset after lockout, power the unit down & restart after the 5 minute cooldown period.
 - Once the fire pit has been ignited **DO NOT** leave unattended.

FIRE PIT SHUT-DOWN

- Turn off the fire pit using your designated powering source - either remote control or wall switch.
 - IMPORTANT: For Remote Control use: You must also turn off the power to the electrical outlet or gas to the fire pit in order to prevent an accidental start.
- Once the fire pit is cooled, you may put the appropriate cover over your feature for protection.

Warning

OVERHEATING: The Fire Pit will automatically close the gas valve if temperatures exceed 175° F inside the valve box to prevent component damage. When the unit cools below 175° F it will automatically restart. To correct overheating, ensure that the enclosure has adequate ventilation.

OPERATION & USAGE CONT'D.

HELPFUL TIPS FOR PROPER OPERATION

1. Cross ventilation is REQUIRED! A minimum of 1 square inch of ventilation is required for every 25,000 BTUs on each side of the installation. Air flow is your friend!
2. Media (lava rock) minimum of 1/2" and no larger than 2" in diameter.
3. Media must not cover the pilot. The pilot needs air. Avoid packing media against the pilot.
4. Media must be approved by the appliance manufacturer.
5. A heat shield/Pan MUST be installed between the burner and Electronic Ignition Valve
6. The Electronic Ignition Valve has a temperature safety shutoff at 175° F.
7. Be sure the gas shut off valve is open.
8. If using wire nuts, be sure they are weather proof and use dielectric grease on the wires.
9. The unit is water resistant. NOT water proof! DO NOT PUT IN WATER OR SUBMERGE.

LED DIAGNOSTIC CODES

LED DIAGNOSTIC CODES	
OFF	NO POWER / INTERNAL FAULT
ON	NORMAL OPERATION
1 FLASH	HOT START, THERMOCOUPLE HOT AT POWER UP
2 FLASHES	TRIAL LOCKOUT, MAXIMUM IGNITION TRIALS EXCEEDED WITHOUT FLAME DETECTION
3 FLASHES	FLAME LOSS LOCKOUT, EXCEEDED MAXIMUM LOSSES OF FLAME AFTER PROVING BURNER ON.
4 FLASHES	FLAME SENSE FAULT
5 FLASHES	VALVE FAULT
FAST FLASH	SAFETY SHUTDOWN

WIRE GAUGE CHART

120 VAC Primary Input - 300 W Output

Distance* Feet	2#6AWG	2#8AWG	2#10AWG	2#12AWG
5 ft.	12 VAC	12 VAC	12 VAC	12 VAC
10 ft.	12 VAC	12 VAC	12 VAC	13 VAC
20 ft.	12 VAC	12 VAC	13 VAC	13 VAC
30 ft.	12 VAC	13 VAC	13 VAC	14 VAC
40 ft.	13 VAC	13 VAC	14 VAC	
50 ft.	13 VAC	13 VAC	14 VAC	
60 ft.	13 VAC	14 VAC		
70 ft.	13 VAC	14 VAC		
80 ft.	13 VAC	14 VAC		
90 ft.	14 VAC			
100 ft.	14 VAC			
110 ft.	14 VAC			

* Length of run to light from transformer.

Control Timing (control used in TOP-500EIS)

Pre-Purge	3.25 seconds
HSI Warm Up	5 seconds
Trial for Ignition	10 seconds
Flame Failure Response	10 seconds Max
Inter-Purge	5 seconds
Flame Loss Recycles	10 seconds
Flame Loss Recycle Delay	None

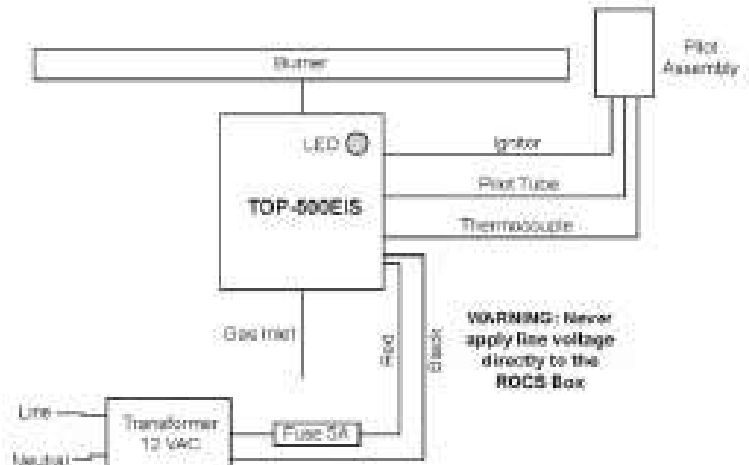

TROUBLESHOOTING

SEQUENCE OF OPERATION	FAULT	CHECK	RESULT	ACTION(S)
Power ON	No Function / No LED Indication	Check for 14V at Transformer	No or low voltage	Make sure transformer is powered. If so, replace transformer.
		Check for 14V at Control Box	No or low voltage	Check wiring for continuity, replace if broken. Ensure wire is <50 feet long and 12AWG minimum (smaller number is bigger wire). Replace with larger wire or shorten length. Replace with correct wiring if incorrect.
Igniter Warm-up	LED on, No Ignition	Check for breaks in Pilot Igniter	Broken	Replace Pilot Igniter.
		Check Pilot Igniter wiring & Connector	Damaged or Broken	Repair.
Trial for Ignition	Igniter ON, does not light Control goes through all ignition attempts then enters 2 LED flash lockout	Is pilot valve opening?	No. Pilot gas flow	Check input gas pressure. Maximum pressure 1/2 PSI. Install regulator if higher.
				Check voltage to pilot valve. Voltage should read >10.2VDC. Check "No or Low Voltage" above if less.
				Check pilot coil for open circuit. Replace pilot valve if open.
			Ensure air has been bled from gas line	
			Consult burner manufacturer for minimum gas pressure	
			If natural gas, ensure pilot jet is not for LP	
	Pilot lights but goes off at end of trial without main burner. 2 flash lockout after end of trials. Flame is not detected.	Is the thermocouple securely connected to the control box?	No	Check pilot injector for clogged jet. Clean or replace.
				If pilot can be lit with a match, check igniter position and adjust, or check "No or Low Voltage" above.
			Check for clogged pilot or injector and clean.	
			Check for correct pilot injector. (LP or NG)	
Burner ON	Units shuts down after flame detected	LED flashing 3 times, no recycle?	Yes	Maximum flame losses per heat cycle exceeded. Recycle power to reset. Ensure pilot flame is impinging on the thermocouple and is adequately sheltered from the wind. If impingement is consistent and no wind present, replace thermocouple.
		LED flashing 4 times, no recycle? (Flame sense fault)	Yes	Turn power off for 10 seconds and back on. If persistent, replace control module.
		LED flashing 5 times, no recycle? (Valve Fault)	Yes	Turn power off for 10 seconds and back on. If persistent, check "No or Low Voltage" above. If voltage is okay, replace control module.
		Shuts down before main burner lights	Yes	Check "No or Low Voltage" above.
		Shuts down after being on for several minutes or hours and does not re-light	Yes	Over temperature - ensure control compartment remains under 175° F. If continued operation above this temperature, life of product will be reduced.
		Unit shuts down for 1 minute every 24 hours	Yes	This is normal operation for validation of safety circuitry.

TROUBLESHOOTING CONT'D

THIS SECTION DEMONSTRATES POTENTIAL ISSUES & COUNTERMEASURES TO REPAIR YOUR UNIT

THE ELECTRONIC IGNITION VALVE IS INSTALLED BUT WHEN TURNED ON NOTHING HAPPENS: The most common cause is an electrical wiring or power issue. Inspect all electrical connections carefully to confirm all wires from the transformer to the fire feature are connected properly. If wiring is properly connected, disconnect the wires at the fire feature and use a multimeter to confirm a minimum of 12 volts when the fire feature is turned on. If there is not a minimum of 12 volts at the fire feature, conduct the same test at the transformer to determine if the transformer is truly producing a minimum of 12 volts. If you do have a minimum of 12 volts at the fire feature contact us for further assistance.

THE ELECTRONIC IGNITION VALVE IS TURNED ON, THE IGNITER GLOWS ORANGE AND GAS CAN BE HEARD FLOWING, BUT DOES NOT IGNITE: The two most common causes to this fault are; Air in the Gas Line or low Electrical Current to the fire feature.

Air in the Gas Line:

New gas line installations often have air trapped inside that must be removed or purged prior to installing the Electronic Ignition Valve. If the line has not been properly purged, it may take several cycles of turning the fire feature on and off before the all the air is purged from the gas line.

Understanding how the Electronic Ignition Valve operates will help you go through the purging process. When you turn on the Electronic Ignition Valve, the igniter will begin to glow, followed by the pilot gas valve opening 4 seconds later. During next 3 minutes the igniter will cycle on and off every 30 seconds while the pilot gas valve will remain on the entire time. Accordingly, if you are attempting to purge air from the gas line, engage the system and leave it on for approximately 3 minutes. Next turn it off and then back on. Let the system run for an additional 3 minutes. When purging air from a new gas line, you may need to cycle the power several times as described above before gas begins to flow. If at any point you smell gas and still don't have ignition, you should attempt to light the pilot flame with a hand held lighter. If ignition occurs when you light it by hand, please read the section titled **Electrical Current**.

Electrical Current:

If purging the gas line does not solve the problem, the ignition failure is most likely that the igniter is not getting hot enough to light the gas. The main reason an igniter will not reach full temperature is low amperage.

Electricians will commonly check the electrical power, note there are a minimum of 12 volts and think everything is fine electrically, so there must be a problem with the Electronic Ignition Valve.

The deficiency is not in the volts but rather the amps.

Amperage reaching the fire feature is dependent on the gauge wire used between the transformer and the fire feature. Our installation instructions require no less than 12 gauge wire up to 50 feet and 10 gauge for installs over 50 feet. Smaller wire size will often be the problem in ignition. Steps to check for sufficient amperage:

TROUBLESHOOTING CONT'D

THIS SECTION DEMONSTRATES POTENTIAL ISSUES & COUNTERMEASURES TO REPAIR YOUR UNIT

- » CAUTION: Turn off the gas supply before proceeding.
- » Utilizing clamp on ammeter, clamp the ammeter around one of the wires providing power to the Electronic Ignition Valve.
- » Turn on the fire feature.
- » Amperage should range between 1.4 to 1.6 amps initially. Four seconds after being turned on the amperage will jump to approximately 2.0 amps.

If the amperage listed previously is not present AND the wire gauge used was less than listed above, change the wiring. Otherwise contact us for further assistance.

THE FIRE FEATURE WAS TURNED OFF, BUT SMALL FLAMES CAN STILL BE SEEN FLICKERING FROM THE FIRE FEATURE: Turn the fire feature back on, let the main burner light and then turn it off again. You may need to do this several times. Small pieces of debris in the gas line may get caught in the main or pilot valve preventing it from completely closing. This is common a new gas line. By cycling power you can often dislodge the debris. If cycling power does not rectify the problem, turn the gas off using the manual gas shutoff and contact us for further assistance.

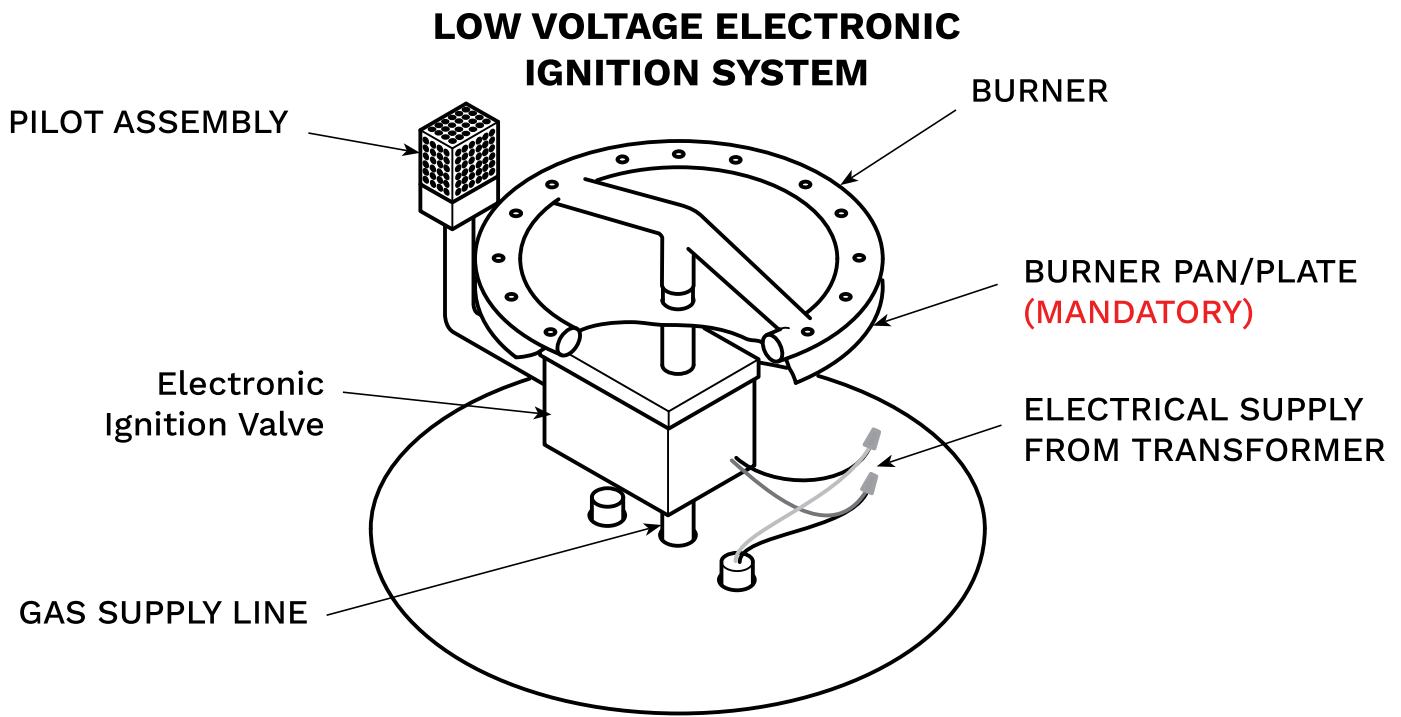

MAINTENANCE

THIS SECTION SHOWS YOU HOW TO MAINTAIN AND UPKEEP THE FIRE FEATURE

CLEANING

Inspect the appliance before initial use. Clean the appliance at least annually and have it inspected by a qualified field service person.

Periodically examine the burner. If the burner is dirty, clean it with a soft wire brush. Remove any dirt or debris in this area. This will ensure long life and trouble-free operation.

The easiest way to clean the fire pit is to let it cool completely off. Spray the enclosure off with water. Note: Do NOT spray water directly onto the burner and igniter and wipe clean with a dry cloth.

When not in use and after cooling, cover your fire pit with a full length cover. The cover will help protect your fire pit from detrimental effects of weather and environmental pollutants (see your local The Outdoor Plus dealer for details).

Before placing the cover on the fire pit, make sure the unit is shut off, that the gas lines are disconnected and that the unit has had sufficient time to cool.

More frequent cleaning may be required as necessary. It is imperative the control compartment, burner and circulation air passageways of the appliance be kept clean and free.

MAINTENANCE

Annually have a Licensed Gas Plumbing Technician check the hose connecting the propane gas cylinder to ensure it is not cracked or damaged in any way. All natural gas hook-ups should be serviced and inspected only by qualified installers only.

Spiders and other insects can nest in the burners and block the gas and airflow to the burner ports. This creates a dangerous condition that can result in a fire from behind the valve panel. Inspect and clean the

burners periodically.

Any guard or other protective device removed for servicing the appliance must be replaced prior to operating the appliance.

Inspect the fuel supply connection for signs of leakage (including the hose for propane models) before each use of the appliance.

Do not repair or replace any part of your fire pit. Have a qualified technician perform all service. Any repairs made by a non-approved service technician will void your warranty.

STORAGE

When your fire pit is not in use, turn off the gas at the source.

This appliance can be store indoors only if it has been disconnected from its fuel supply.

Store propane cylinders outdoors in a well-ventilated area out of reach of children. Disconnected cylinders must have threaded valve plugs tightly installed and must not be stored in a building, garage, or any other enclosed area.

To extend the life of your fire pit, protect and cover it from the elements when not in use. **(See Figure 7)** Ensure the appliance has ample time to cool off after use and prior to installing storage cover. Damage caused to storage cover due to heat or burns are not covered by warranty.



Figure 7

MAINTENANCE CONT'D

THIS SECTION SHOWS YOU HOW TO MAINTAIN AND UPKEEP THE FIRE FEATURE



**VISUALLY INSPECT
THE PILOT.**

REMOVAL OF DEBRIS

- Do NOT perform the maintenance until surfaces of the fire feature are cool to the touch. The Outdoor Plus recommends leaving the fire pit off for at least 1 hour prior to servicing.
- Remove any debris on or around the fire feature such as spider webs, dirt, etc. by using a dry brush or compressed air.
- Pilot debris removal: Unscrew the pilot cover from the igniter. Use a dry brush or compressed air to clean out the pilot igniter. Place the pilot cover back on with the screw, after pilot igniter is cleaned.
- Cleaning soot off of the Thermocouple: Once every six months or as needed. Remove media around pilot, then the pilot hood lid by unscrewing the two screws. Clean thermocouple of any soot using soft brush. Be careful not to damage hot wire element. Place media back in, see Section 9 – Fire Media Usage.
- Visually inspect the pilot. The pilot flame should cover 3/8 inch to 1/2 inch of the thermocouple. Cleaning of the pilot orifice may be required by removing pilot hood screws, pilot hood, and removing the brass orifice.
- **WARNING: Failure to position the parts in accordance with these diagrams or failure to use only parts specifically approved with this appliance may result in property damage or personal injury.**



REPLACEMENT PARTS

THIS SECTION SHOWS REPLACEMENT PARTS YOU MAY ORDER TO REPAIR A Low Voltage Pans & Burners SYSTEM



**12V/13V/14V
TRANSFORMER**
OPT-12V



**BLUETOOTH
CONTROLLER**
TOP-500BLU



**24" PILOT IGNITER
ASSEMBLY**

TOP-500PIR
MINI & STANDARD CAPACITY UNITS

TOP-500PIRHC
HIGH CAPACITY UNITS



**PILOT IGNITER
COVER**
TOP-PIC



**PILOT IGNITER
GLOW PLUG**
TOP-PIGP



PILOT ORIFICE(S)

TOP-PI23 | #23 ORIFICE
MINI CAPACITY UNITS

TOP-PI39 | #39 ORIFICE
STANDARD & HIGH CAPACITY UNITS

CLEARANCE FROM COMBUSTIBLES

THIS SECTION OUTLINES THE CLEARANCE FROM COMBUSTIBLES REQUIREMENTS FOR SAFE OPERATION

Clearance for units with up to 65,000 BTUs - For Outdoor Use Only

Flooring

All fire pits and fire features must be installed on non-combustible flooring. If the fire feature is installed on a combustible floor, such as wood decking, a non-combustible floor paneling MUST be properly installed underneath.

Installation

We suggest that our products be installed by professionals that are locally licensed by the authority having jurisdiction in gas piping.

Service

We suggest that our products be serviced by a professional certified in the US by the National Fireplace Institute (NFI) as NFI Gas Specialists

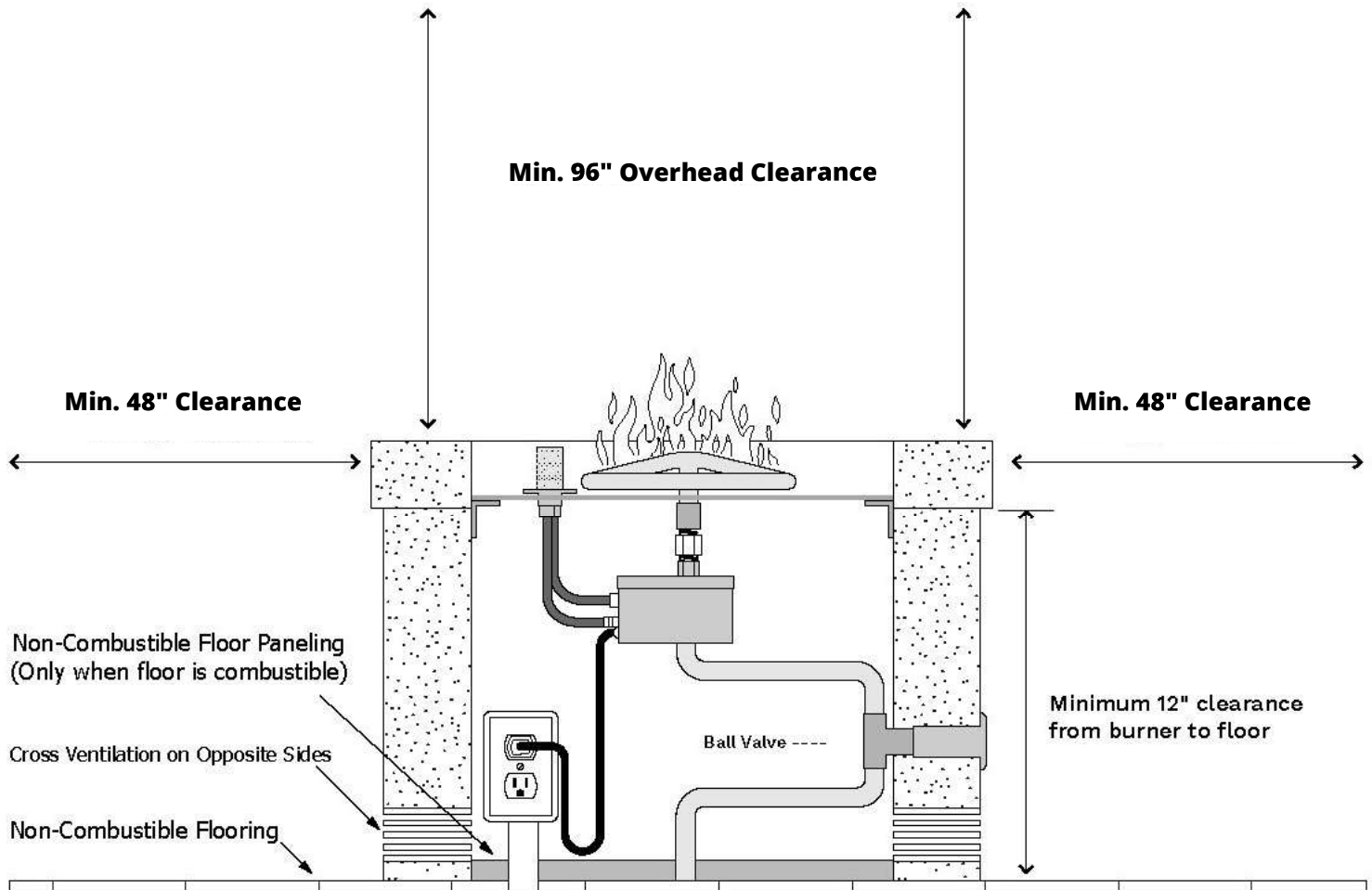

CLEARANCE FROM COMBUSTIBLES

THIS SECTION OUTLINES THE CLEARANCE FROM COMBUSTIBLES REQUIREMENTS FOR SAFE OPERATION

Clearance for units 66k to 200k BTUs - For Outdoor Use Only

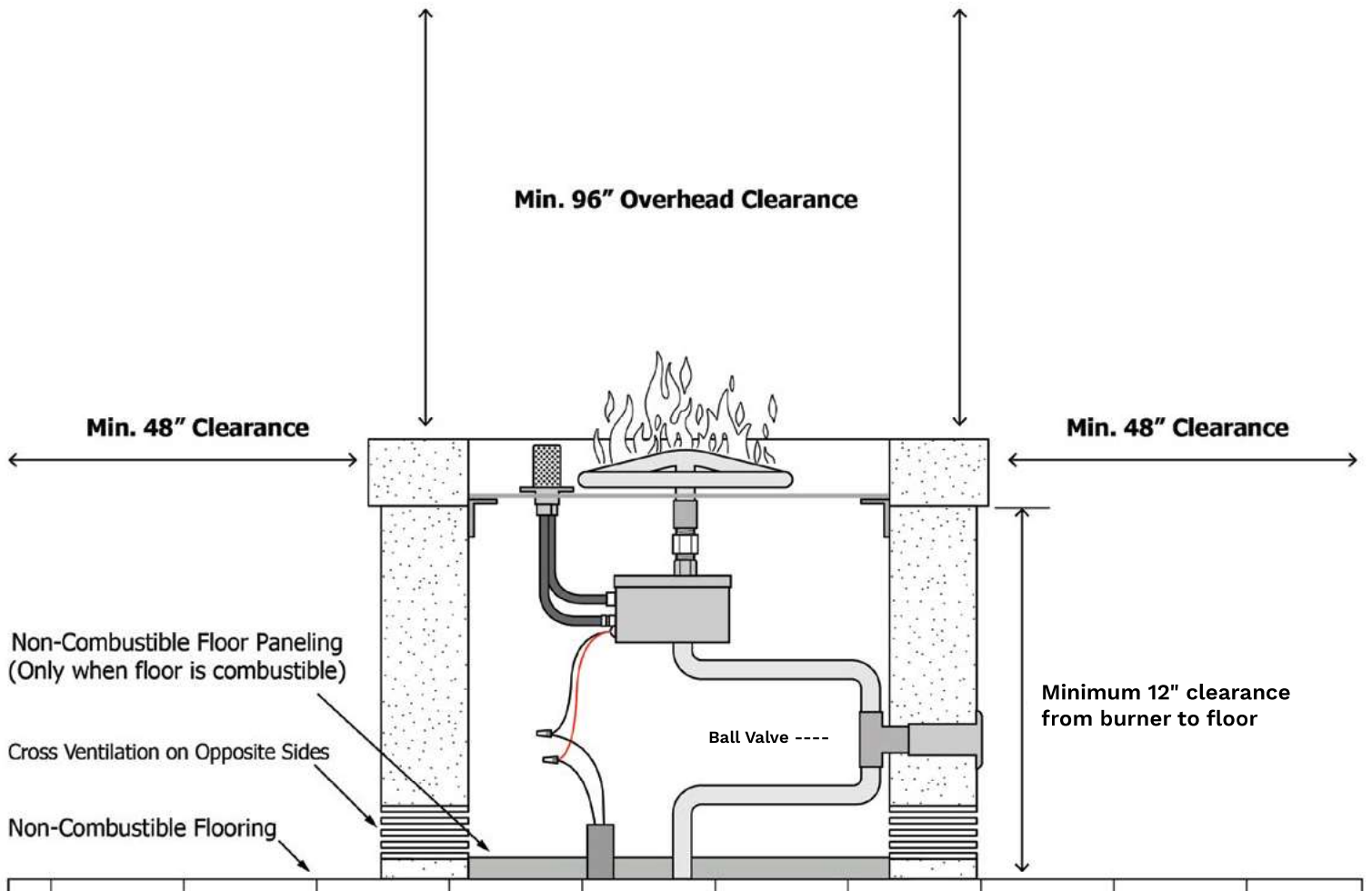

CLEARANCE FROM COMBUSTIBLES

THIS SECTION OUTLINES THE CLEARANCE FROM COMBUSTIBLES REQUIREMENTS FOR SAFE OPERATION

Clearance for units 201k to 400k BTUs - For Outdoor Use Only

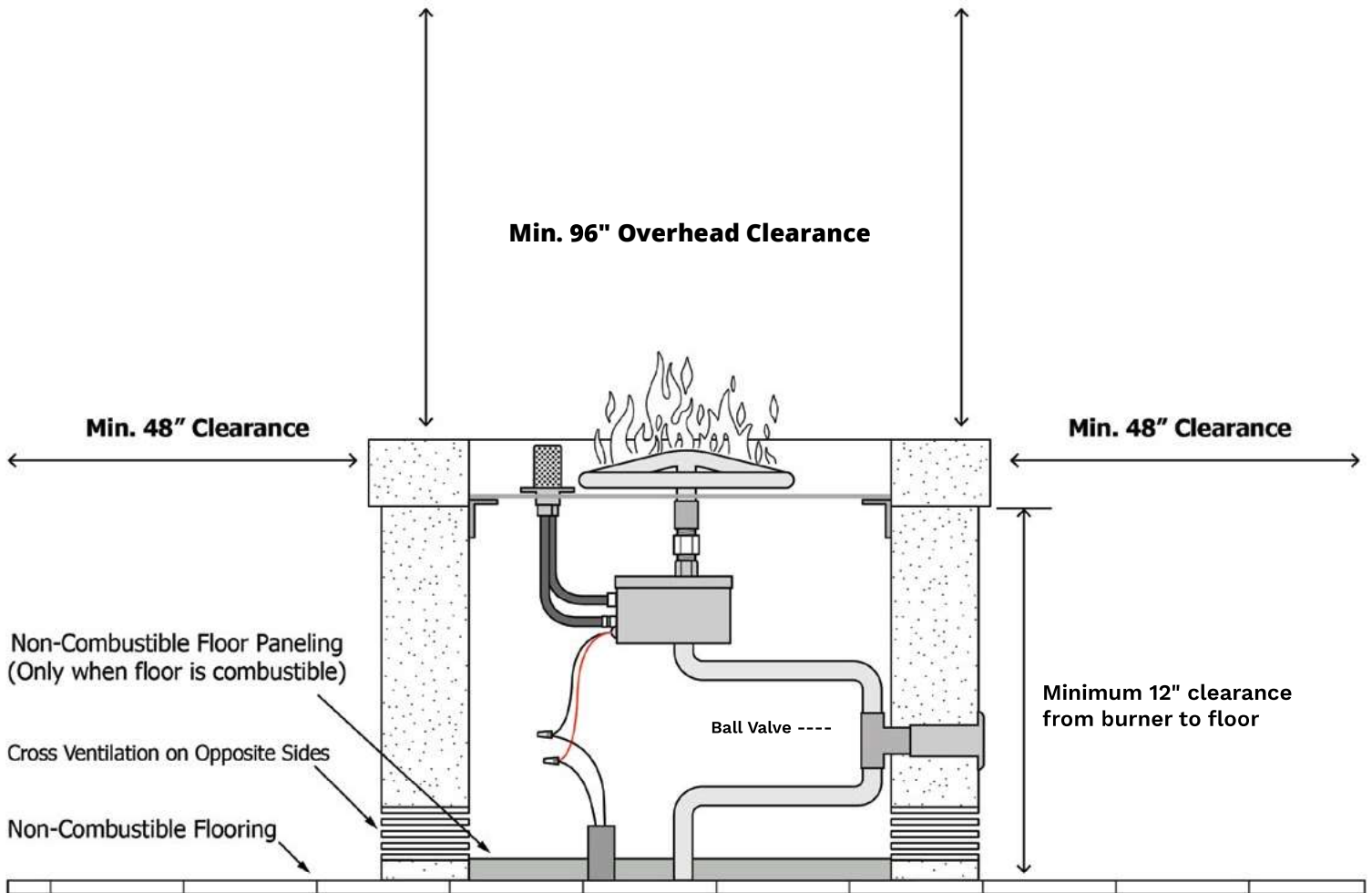

CLEARANCE FROM COMBUSTIBLES

THIS SECTION OUTLINES THE CLEARANCE FROM COMBUSTIBLES REQUIREMENTS FOR SAFE OPERATION

Clearance for units 401K BTUs and up - For Outdoor Use Only

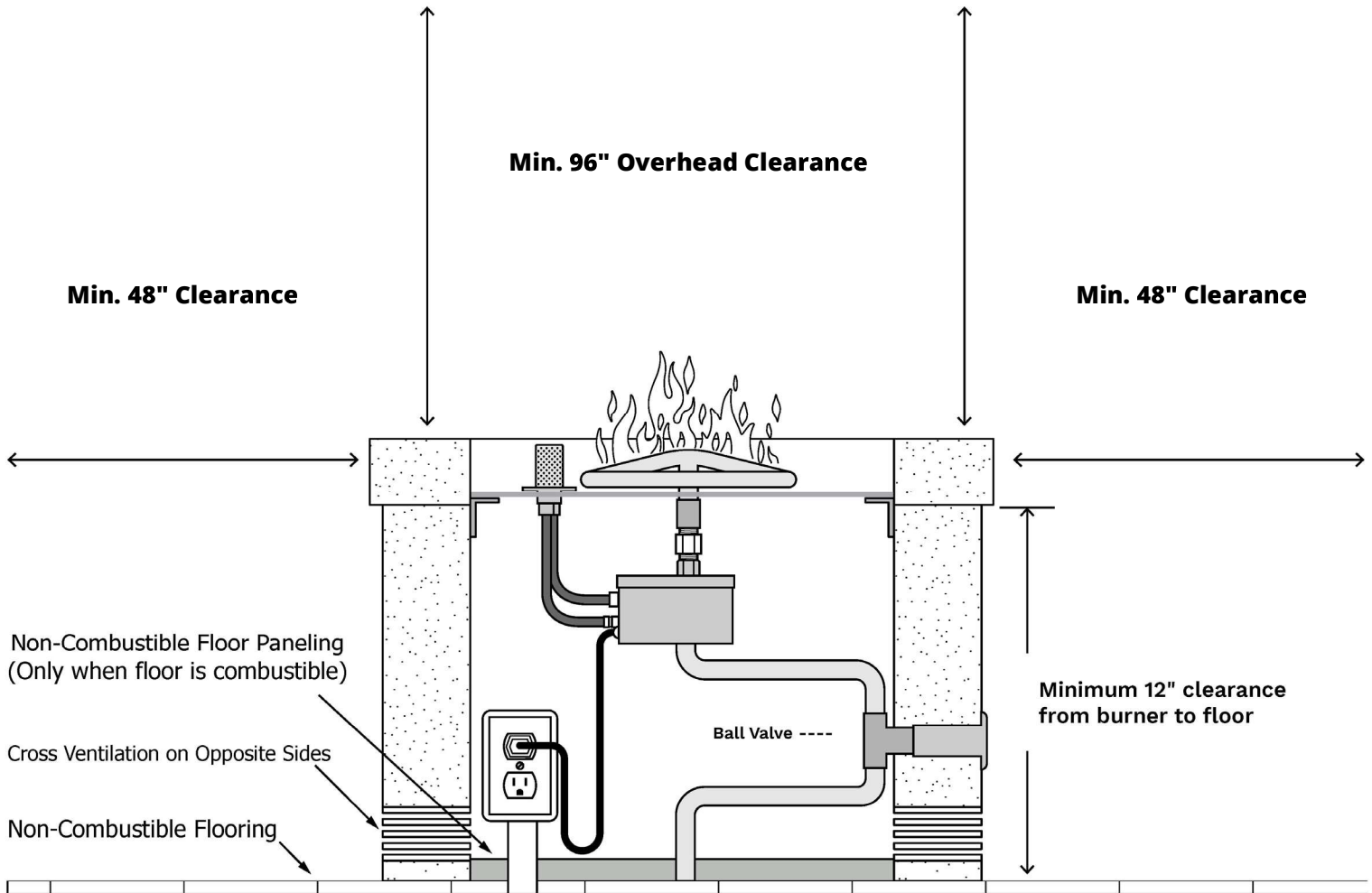

WARRANTY INFORMATION

THIS SECTION OUTLINES THE WARRANTY OFFERED BY THE OUTDOOR PLUS

The Outdoor Plus Company (TOP) warranties its products against manufacturing defects that prevent safe and proper functioning as follows:

Electronics, Gas Valves, & Pilot Assembly:

Commercial - 6 Months ; Residential - 1 Year

Stainless Steel & Aluminum Pans:

Commercial - 1 year; Residential - 5 years

Burner Ring & Burner Bars:

Lifetime Warranty

Electrodes & Spark Igniters

Not Warrantied (due to lifespan)

- This commences from the date of original sale / shipment from The Outdoor Plus
- The warranty on parts and in-house labor will apply only to claims presented to us by T.O.P's original customer and is in lieu of all other warranties expressed or implied.
- The defective product must be sent back to TOP with a Return Merchandise Authorization (RMA) issued by TOP for that specific product which states the nature of the defect or warranty claim. The original purchase information will be required.
- Product to be returned should be packed carefully. The Outdoor Plus is not responsible for shipping damage on returned items.
- RMA's are only valid for 30 days which states the nature of the defect or warranty claim after the expiration date.
- The RMA number must be indicated on the outside of the return package and a copy of the RMA should be placed in the package with product.
- TOP is not responsible for damaged caused by overheating, modification, abuse, improper storage, installation, or maintenance.
- TOP is not responsible for surface level rust on metal products.
- TOP is not responsible for the actions including negligence of the installer.
- Any labor involving installation or maintenance with the unit is not covered.
- This warranty does not cover claims for incidental or consequential damage and indirect collateral expenses arising from product defects or warranty repairs. Products manufactured by TOP include cLCus, UL, or CSA Certified models, of which cannot be altered or modified in any way.

- TOP is not responsible for local codes and will not accept a return on any product that is not approved for installation. Please check with your local authorities or governing agencies for proper approvals before purchasing.

PRODUCT RETURN POLICY

- No returns on made-to-order goods.
- No returns on custom features, NO EXCEPTIONS.
- If a product is delivered incorrectly, it is the recipients responsibility to notify TOP within 48 hours. TOP is not responsible for incorrect or damaged packages and shipments 48 hours after they have been received. Please call (909) 460-5579 or email support@theoutdoorplus.com for help with warranty, replacements, returns, or if you have any support related questions.

PRODUCT TESTING PROGRAM

If you believe a unit or component you received is defective, The Outdoor Plus will gladly test any component at T.O.P's facility. TOP will cover shipping back to you.

DEFECTIVE

If an item is found to be defective it will be repaired or replaced at T.O.P's discretion. TOP will absorb all costs of outgoing freight and replacement costs if product is in warranty.

NON-DEFECTIVE

If the product is found to be non-defective it will be returned to the customer - no credit will be given.

TOP ERROR

If a return is needed due to a mistake on T.O.P's part, we will issue a RMA and Return Services Label. When products are received at TOP, credit will be issued for the products and the outgoing freight on the original invoice.

CUSTOMER ERROR

If an RMA is asked for and covers current new products in the original package, we will authorize the return. The customer is responsible for the return shipping. When products are received we will issue credit for the original customer cost less a 25% restocking charge. Custom orders do not apply.

FREIGHT POLICY

All orders will be shipped FOB Ontario, California, with a standard shipping carrier selected by TOP unless customer specifically requests their own carrier and account. A freight quote may be requested in advance. TOP works diligently with standard carriers to achieve the best discounts available.