

# Béfon

FIRE PIT COLLECTION  
By Starfire Designs®

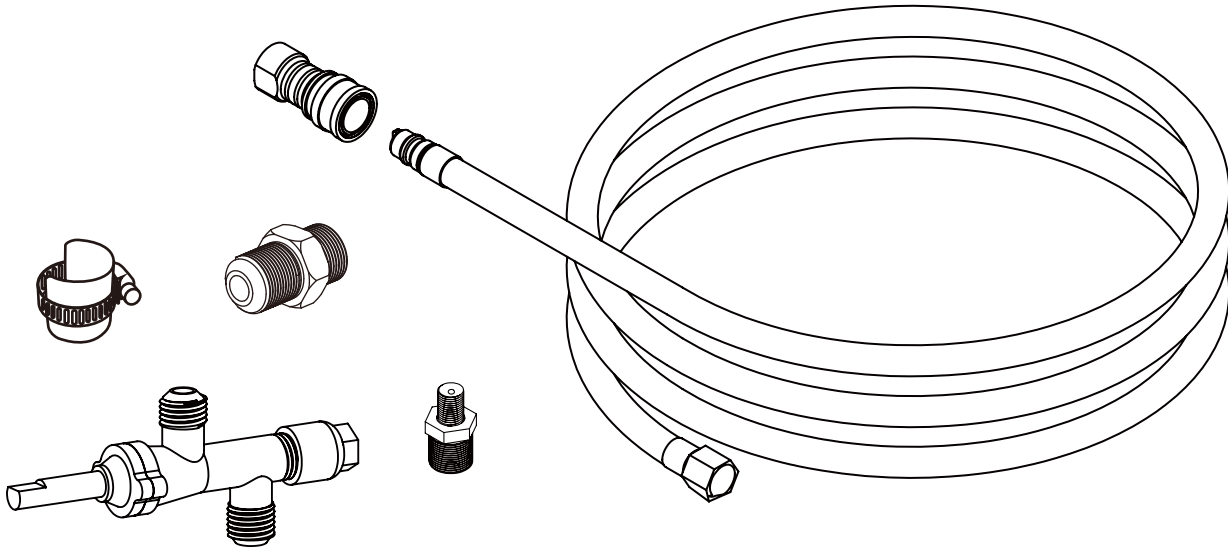

## Natural Gas Conversion Kit Manual

### **⚠ WARNING**

This conversion kit shall be installed by a qualified service agency in accordance with the manufacturer's instructions and all applicable codes and requirements of the Authority Having Jurisdiction. If the information in these instructions is not followed exactly, a fire, explosion or production of carbon monoxide may result causing property damage, personal injury or loss of life. The qualified service agency is responsible for the proper installation of this kit. The installation is not proper and complete until the operation of the converted appliance is checked as specified in the manufacturer's instructions supplied with the kit.

### **⚠ IMPORTANT**

INSTALLER:  
Leave this manual with the appliance.  
CONSUMER:  
Retain this manual for future reference.

### **⚠ DANGER**

#### FIRE OR EXPLOSION HAZARD

If you smell gas:



- Shut off gas to the appliance.
- Extinguish any open flame.
- If odor continues, leave the area immediately.
- After leaving the area, call your gas supplier or fire department.

Failure to follow these instructions could result in fire or explosion, which could cause property damage, personal injury, or death.



# TABLE OF CONTENTS

Important Safety Information .....	3
Parts List .....	4
Natural Gas Conversion Instruction .....	5
Pre-Use Instructions .....	12
Lighting Instructions .....	13
Warranty .....	14

 <b>DANGER</b>	<p><b>CARBON MONOXIDE HAZARD</b></p> <p>This appliance can produce carbon monoxide which has no odor.</p> <p>Using it in an enclosed space can kill you.</p> <p>Never use this appliance in an enclosed space such as a camper, tent, car or home.</p>
	

<p> <b>WARNING:</b> This product can expose you to Carbon monoxide, which is known to the Sate of California to cause birth defects or other reproductive harm. For more information go to <a href="http://www.P65Warnings.ca.gov">www.P65Warnings.ca.gov</a> .</p>
--

# IMPORTANT SAFETY INFORMATION



**WARNING** FIREPIT TABLE IS FOR OUTDOOR USE ONLY

## IF YOU SMELL GAS

- Shut off gas supply to the fire table.
- Extinguish any open flame.
- Do not try lighting any appliance.
- Do not touch any electrical switch; do not use any phone in your building.
- Immediately call your gas supplier from a neighbor's phone.
- Follow the gas supplier's instructions.
- If you cannot reach your gas supplier, call the fire department.

***Installation and repair should be done by a qualified service person. The appliance should be inspected before use and at least annually by a qualified service person. More frequent cleaning may be required as necessary. It is imperative that the control compartment, burners, and circulating air passageways of the appliance are kept clean.***

- **WARNING:** Installation and service must be performed by a qualified installer, service agency or gas supplier.
- **WARNING:** Failure to follow with the safety warnings and precautions in this manual may result in serious bodily injury or death, a fire or an explosion causing damage to property.
- **IMPORTANT NOTICE:** Read and understand all warnings and precautions prior to assembly and use your gas fire table. Improper installation, adjustment, alteration, service or maintenance can cause injury or property damage.



This conversion kit is for changing a liquefied Petroleum(LP) firepit table into a Natural Gas Firepit Table.

# PARTS LIST

- 1, Natural Gas Hose and Quick Disconnect x 1 pc
- 2, Natural Gas Orifice 4.5mm x 1 pc
- 3, Natural Gas Valve x 1 pc
- 4, Primary Air Mixer Sleeve x 1 pc
- 5, Brass Connector x 1 pc
- 6, Natural Gas Conversion Plaque x 1 pc
- 7, Cable Kit x 1 pc
- 8, Hexagon screwdriver( for knob use) x 1 pc

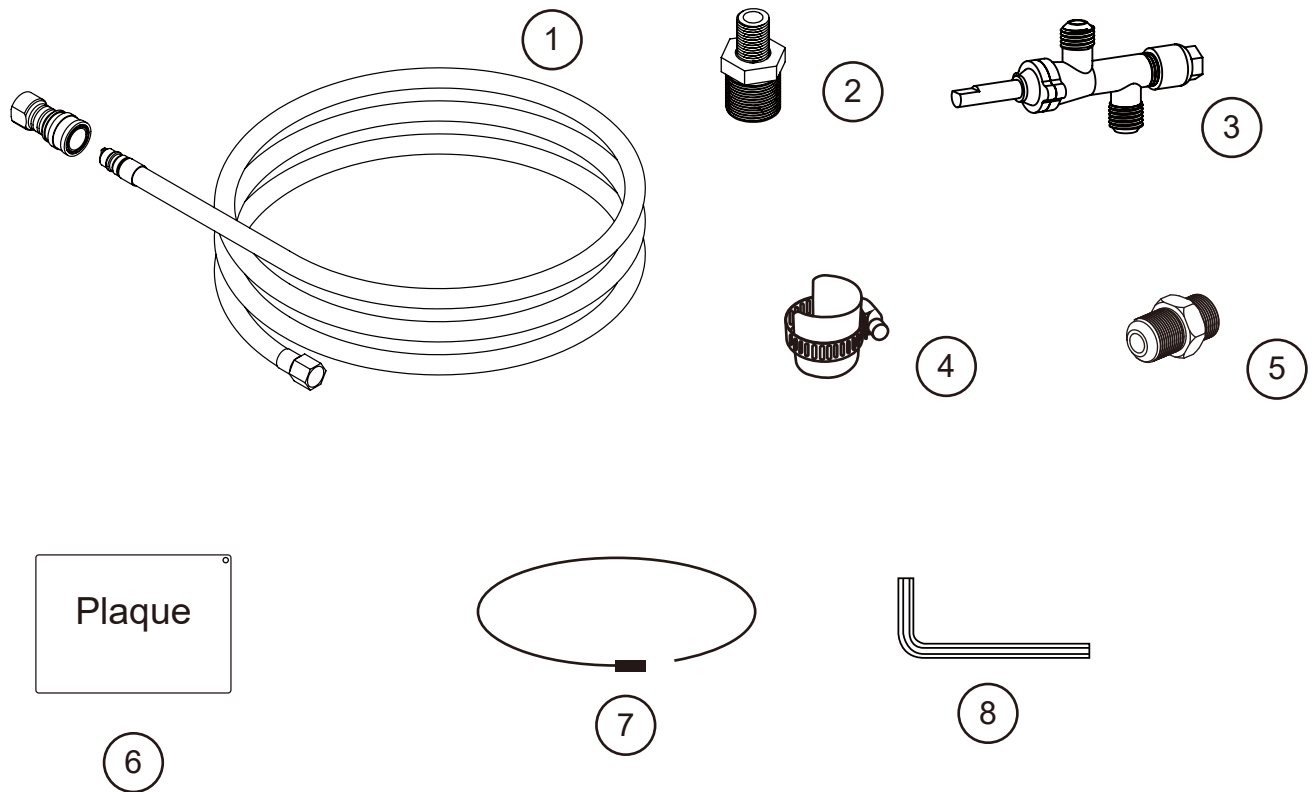

## Applicable Model:

2 pieces Models	CZYG092 LP	CZYG004 LP	CZYG387 LP	CZYG122 LP	CZYG091 LP	CZYS132 LP
	CZYS152 LP	CZYS306-178 LP	CZYS306-M190 LP			
	CZYS226-2 LP	CZYS216 LP	CZYS216-1 LP	CZYS216-2 LP	CZYS1580 LP	CZYS306 LP
1 piece Models	CZYG001 LP	CZYG106 LP	CZYG901 LP	CZYG086 LP	CZYG005 LP	CZYG019 LP
	CZYG221 LP	CZYG006 LP	CZYG248 LP	CZYG249 LP	CZYG186 LP	CZYG238 LP
	CZYG008 LP	CZYG102 LP	CZYG218 LP	CZYG002 LP	CZYG093 LP	CZYG227 LP
	CZYG007 LP	CZYG217 LP	CZYG222 LP	CZYS005 LP	CZYS020 LP	CZYS226 LP

# NATURAL GAS CONVERSION INSTRUCTIONS

1. Disconnect the black LP gas hose from the LP gas tank. Flip the fireplace upside down, placing it on a soft surface to avoid damaging the finish.

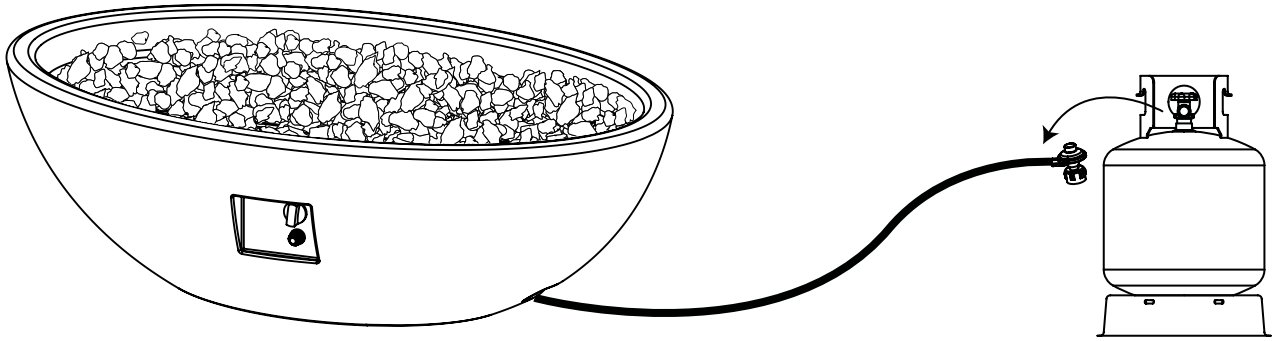

## WARNING

ENSURE THE UNIT IS OFF AND COMPLETELY COOL, AND THE GAS SUPPLY TO THE UNIT IS TURNED OFF.

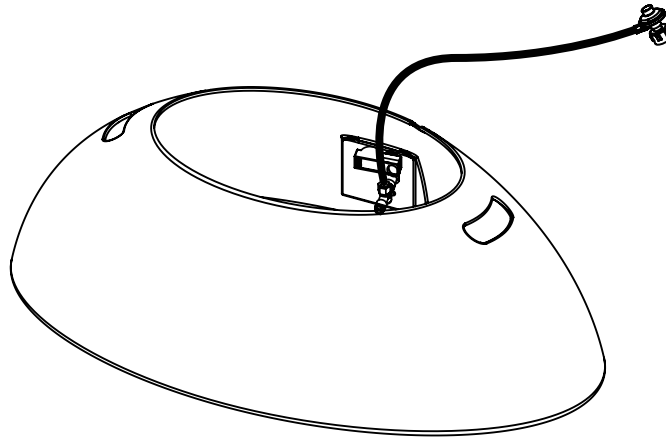

2. Remove the control knob and brass nut from the valve.

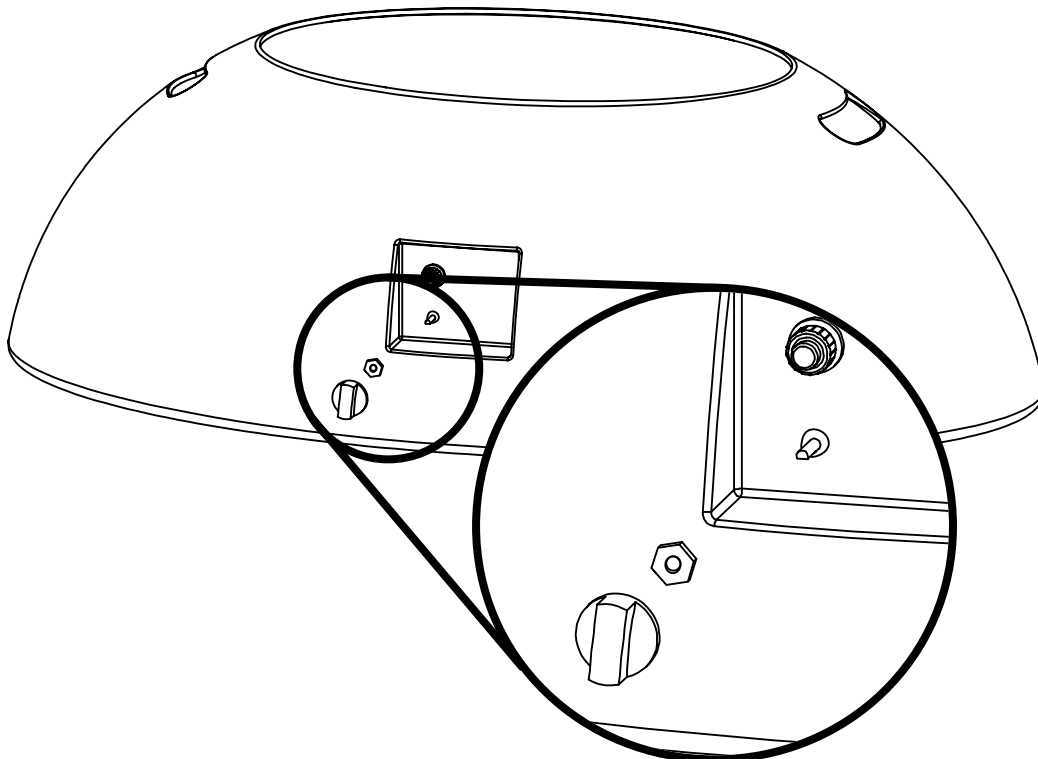

# NATURAL GAS CONVERSION INSTRUCTIONS

3. Disconnect the black LP gas hose from the input valve on the body of the fireplace. Remove flex line from output side of the valve along with the thermocouple.

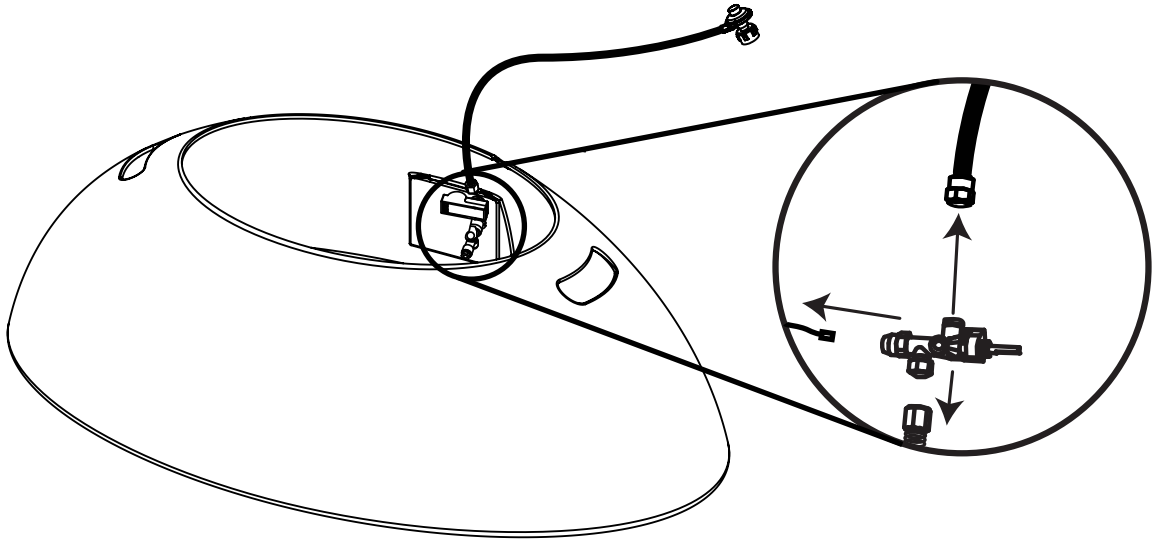

4. Disconnect the flex line from the burner tube inlet by unscrewing the nut at the end of the flex line.

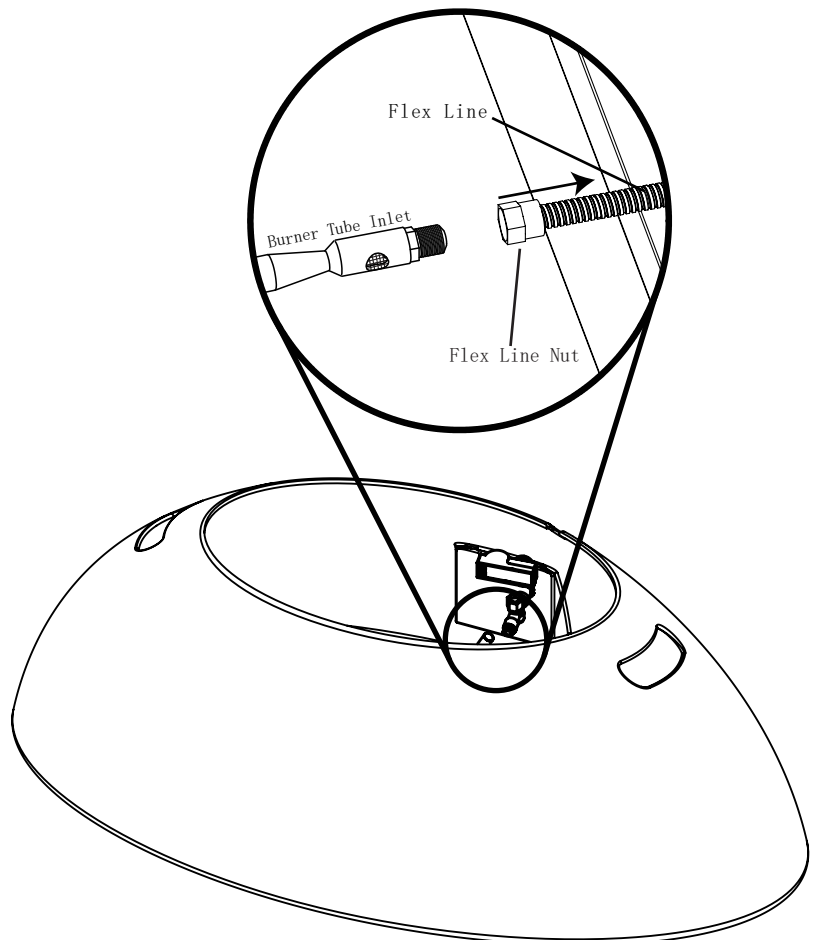

# NATURAL GAS CONVERSION INSTRUCTIONS

5. Remove the LP gas orifice spud from the burner tube inlet.

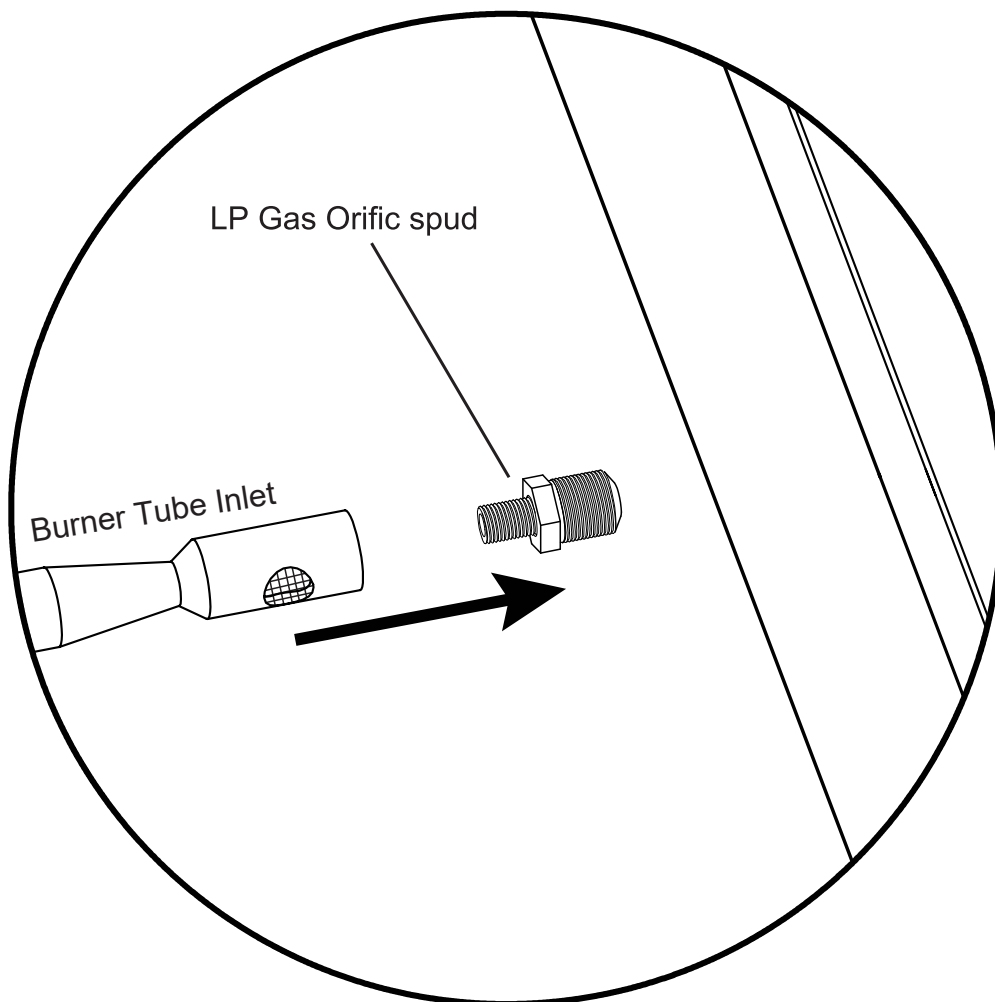

6. Locate the new NG orifice spud. Verify it is the correct number. The sign 4.50 mm should be on the end of the orifice spud.

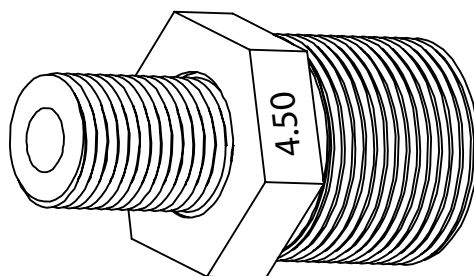

# NATURAL GAS CONVERSION INSTRUCTIONS

7. Slip the sleeve over the primary air opening (see Fig. 1). Next, screw the new NG orifice spud into the burner tube inlet (see Fig. 2).

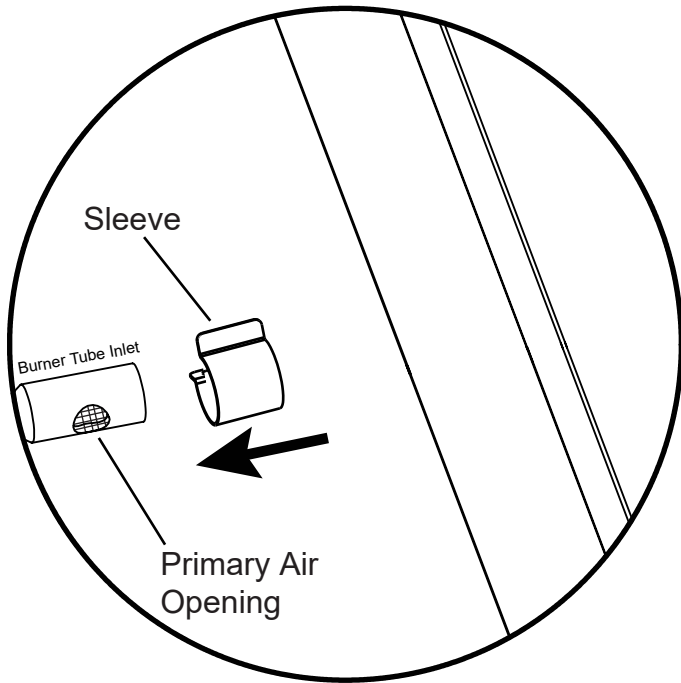

Fig. 1

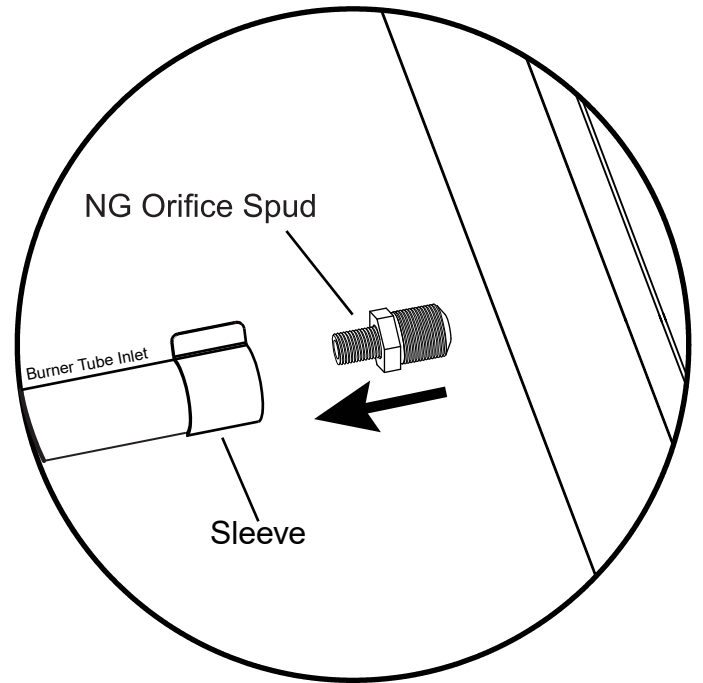
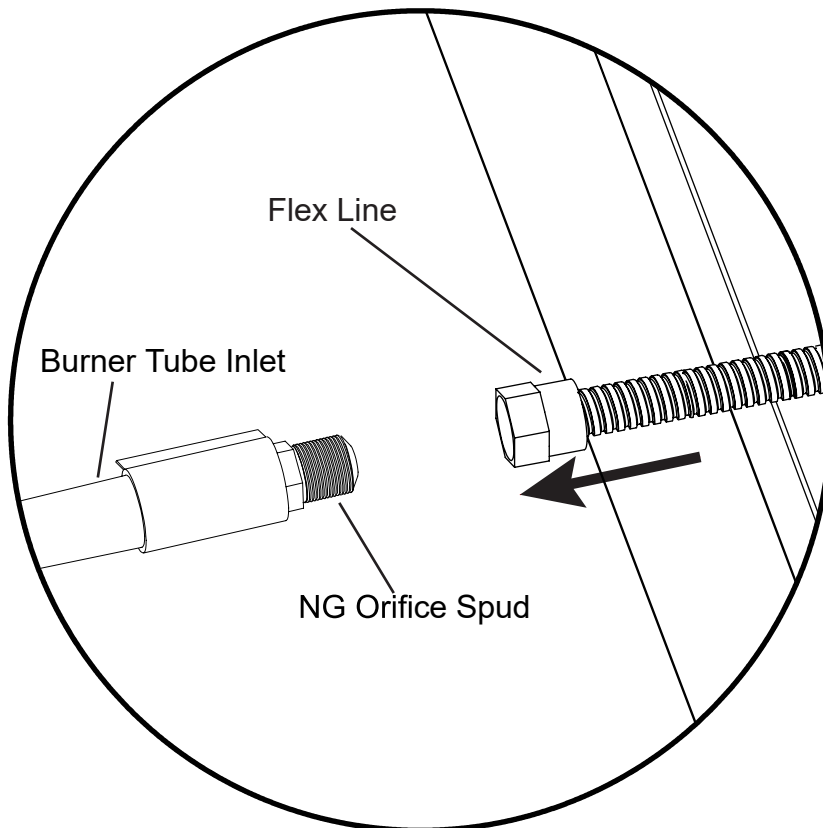

Fig. 2

8. Reattach the flex line to the burner tube inlet.





# NATURAL GAS CONVERSION INSTRUCTIONS

9. Attach the gray NG hose to the input side of the replacement valve on the body of the fireplace. Re-attach the flex line and thermocouple to the replacement valve.

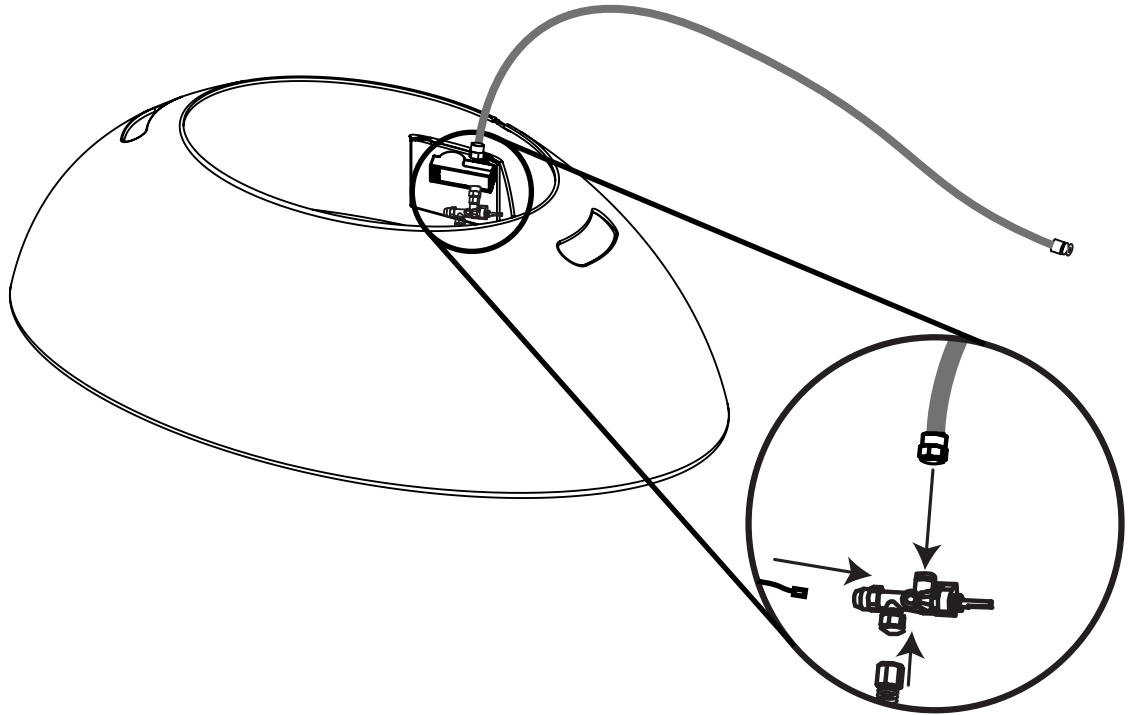

10. Re-attach valve with brass nut. Replace the control knob.

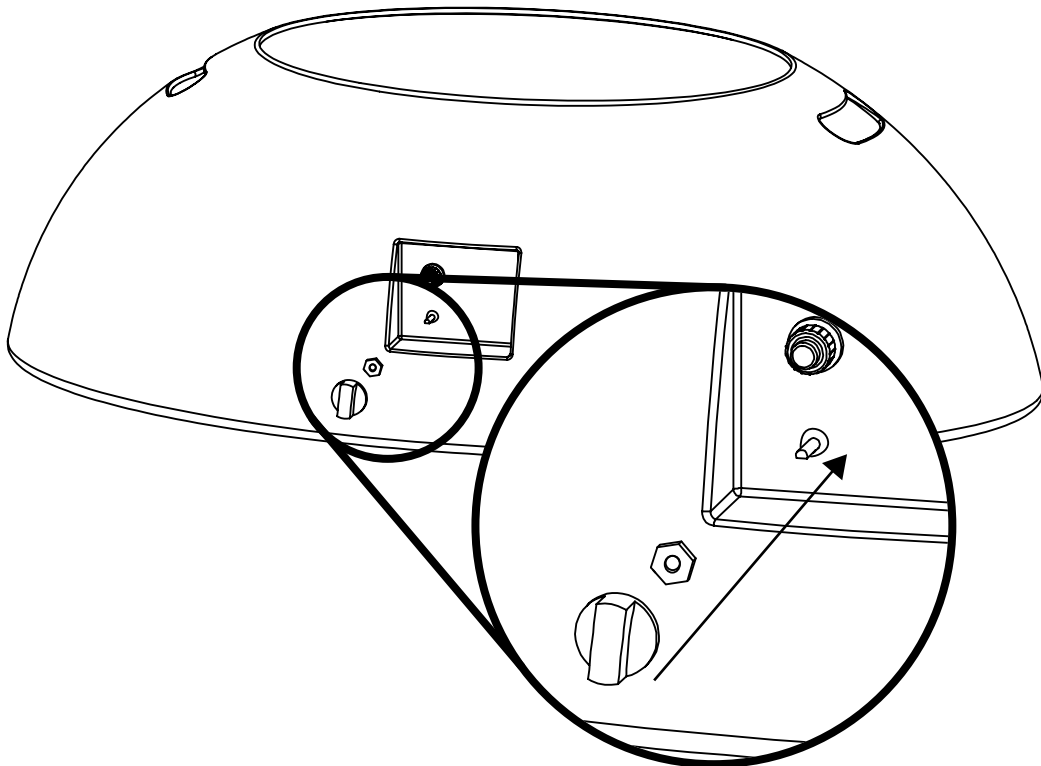

# NATURAL GAS CONVERSION INSTRUCTIONS

11. Attach the quick connect socket to the natural gas source.

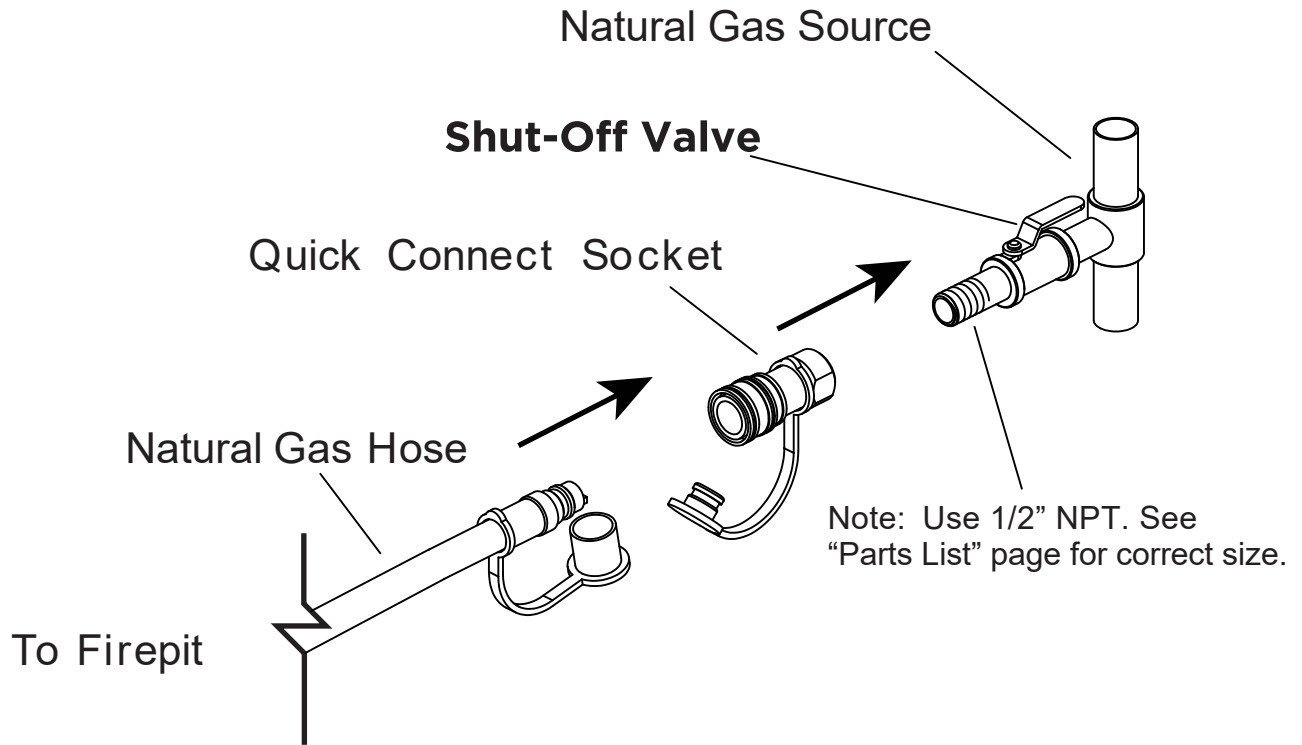

12. After installing the conversion kit, verify that the components are still correctly positioned (see diagram below).

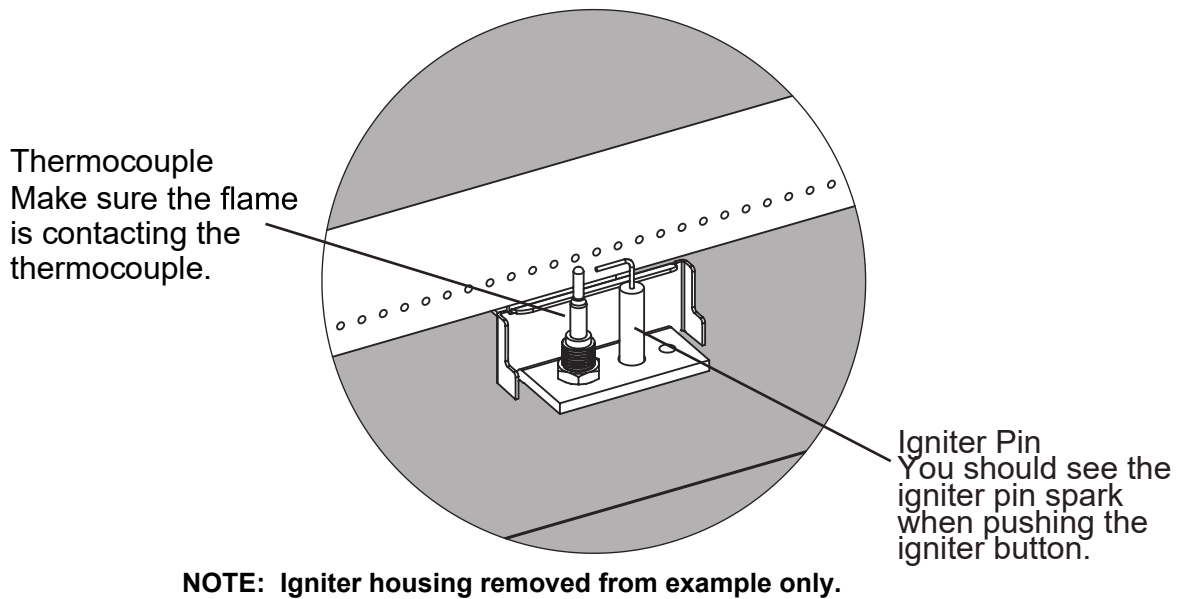

# PRE-USE INSTRUCTIONS

## Notes to Installation Technician

Verify the manifold pressure by using a 3/8" flared T-junction at the location marked in the diagram below. Then, using a digital manometer, verify that the pressure before the orifice is 7 W.C. (1.74 kPa). Also verify that the orifice spud has the 4.5 mm stamp. This will allow you to verify that the input rating of the firepit is correct.

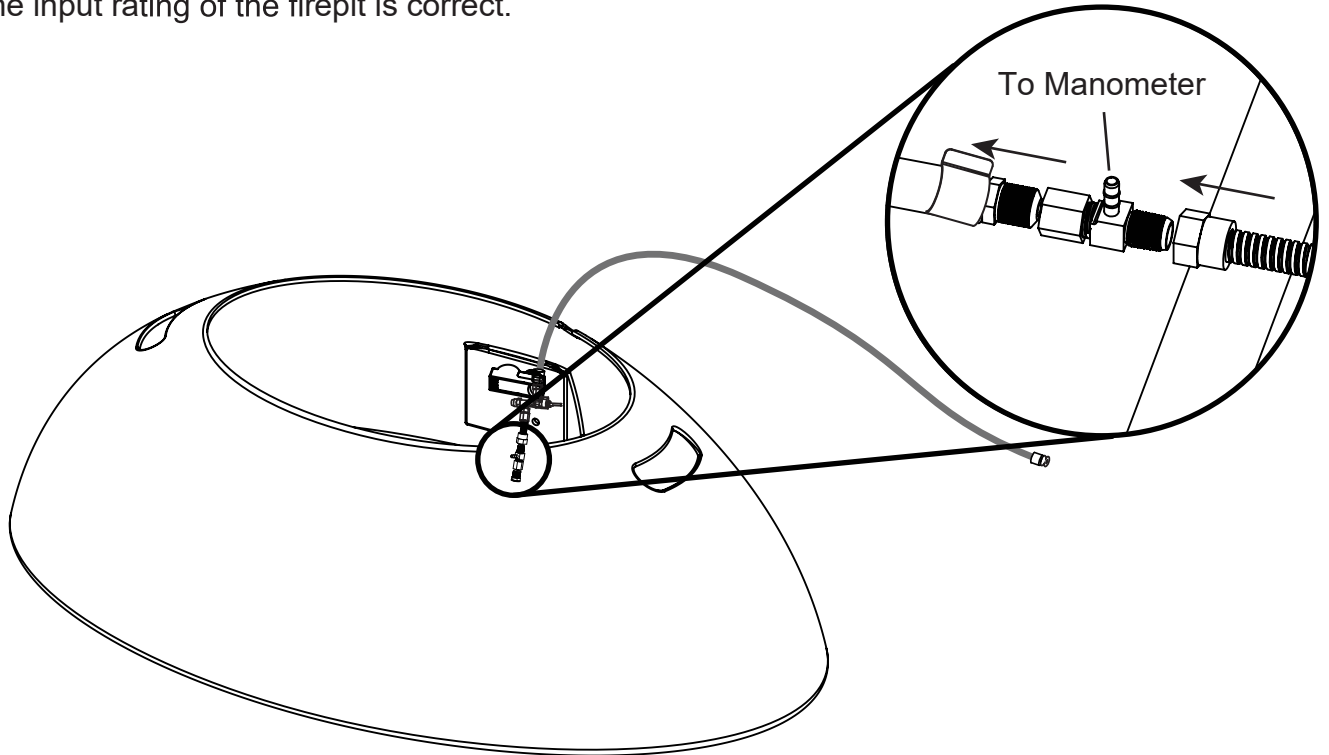

### Installing at Altitude

Installations at elevations above 2,000 ft (609.6 m) may require adjustment. Contact the supplier for further information.

**NOTE: The normal manifold pressure for this converted appliance is 7 inch water column.**

**NOTE: The maximum inlet gas pressure for this unit is 10.5 inch W.C (2.61 kPa).  
The minimum inlet gas pressure for this unit is 3.5 inch in W.C (0.87 kPa).**

# PRE-USE INSTRUCTIONS

## Checking For Leaks

---

1. Make a leak check solution by mixing 1 part dishwashing soap with 3 parts water in a spray bottle.
2. Make sure the control knob on the firepit is in the "OFF" position, then connect your firepit to the gas supply line and turn the gas on.
3. Spray the leak solution on the valve connections, paying particular attention to the areas indicated by arrows in the diagrams.
4. If bubbles appear, shut off the gas supply, disconnect the hose and inspect all connections making sure threads are clear of debris. Reconnect the hose, turn the gas supply on and retest. If you continue to see bubbles, turn the gas supply off, disconnect hose and call the supplier's Customer Service for assistance.
5. If no bubbles appear after 1 minute, wipe away excess leak solution and proceed to "Lighting Instructions."

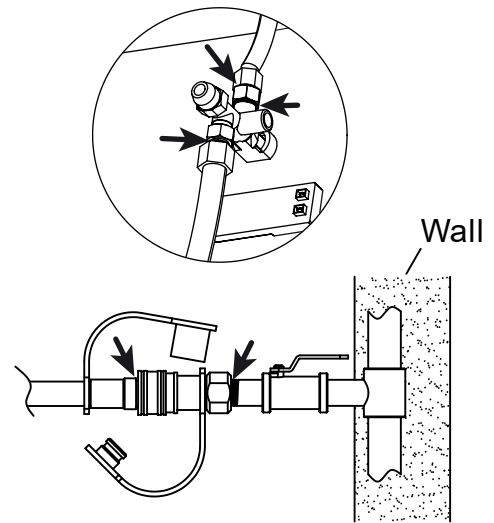

## Conversion Plaque

---

Using wire cutters, remove the plaques that are hanging from the control panel. Use the included cable kit to string all plaques together including NG conversion plaque and reattach them to the control panel.

# LIGHTING INSTRUCTIONS

## Using the Igniter

1. Read and understand all operating instructions before lighting.
2. Before beginning, make sure the control knob is in the "OFF" position.
3. Connect the quick connect socket to the gas supply (see previous pages).
4. Slowly turn the gas on.
5. Prepare to ignite your fireplace by placing one hand on the control knob and one hand on the igniter button (see diagram). **DO NOT** lean over any part of the burner. Verify that the area around the burner is free of hazards.
6. Push and hold the igniter button. You should hear a clicking sound.
7. While keeping the ignition button depressed, use your other hand to push in and turn control knob counter-clockwise to the "LIGHT" position.
8. Once the burner ignites, release the igniter button, but continue to keep the control knob pushed in for 15-20 seconds.

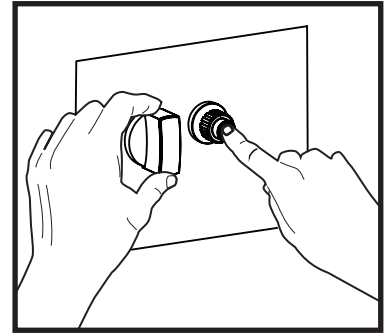

- WARNING:** If ignition does not occur in 20 seconds, turn the control knob to the "OFF" position and turn the gas off at its source. Make sure there is no source of ignition around the fireplace and wait at least 5 minutes until the gas has cleared to repeat the lighting procedure. Failure to do so could result in a large flashback of pooled gas, causing property damage, serious injury, or death.
9. After successfully lighting the fireplace, release the control knob and turn it to the "LOW" setting. Observe the flame and make sure that all the burner ports are lit.
  10. Adjust the flame to the desired height using the control knob.

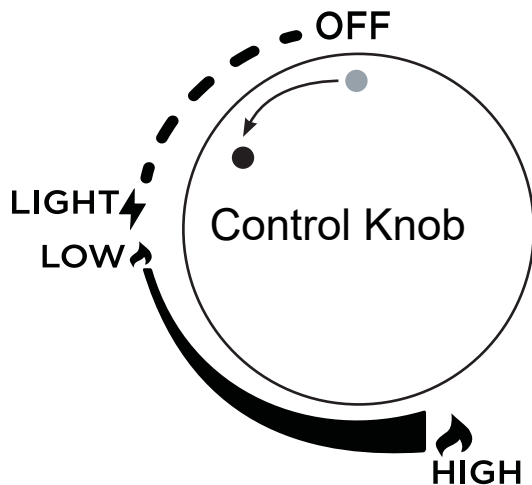

## Flame Height



8-14"
(20.3-35.5 cm)

## Shut-Off Instructions

1. Turn the control knob to the "OFF" position.
2. Turn off the gas supply at the source.

# Warranty

Fire pit's manufacturer, distributor and importer warrants fire features and accessories to be free from defects in parts and workmanship under normal use and service for a period of 2 years from the date of purchase. In the event of such defects, our company will, at its option, repair or replace the defective product. The foregoing is at the discretion of our side.

There will be no charge for the replacement parts or product, however it will be the consumer's responsibility to return the product to the original place of purchase.

We will not be responsible for consequential damages in excess of the purchase price of the product on which such liability is based and the warranty does not cover costs including freight, removal and re-installation.

This warranty is non-transferable and applies only for units that are for non-commercial personal use only.

Under this warranty agreement, all gas lines must be installed by a licensed gas fitter.

Damage caused by shipping, staining and abuse are not covered under this warranty. Dings, dents and scratches, fading and natural weathering are not covered under this warranty. Decorative rock is not covered under this warranty. Improper installations, repair or modifications made by anyone other than our company will void this warranty and any damage caused by such is also not covered under this warranty.

Minor chipping, weather fading, water staining and non-structural hairline cracks are typical of the material of this product and are not covered under this warranty. Some color and texture variation is typical of the material and finish for this product and is not covered under this warranty.

Cast concrete is a hand finished process. As such, this product's finish will vary by unit. There will be a color variance of up to 15% in each unit. There may also be uneven texture or pattern as well as small holes in the surface caused by air or water trapped on the surface during casting. This is a normal trait of cast concrete and is not covered under warranty.