

Gravity Collection | 36" x 36" x 16"

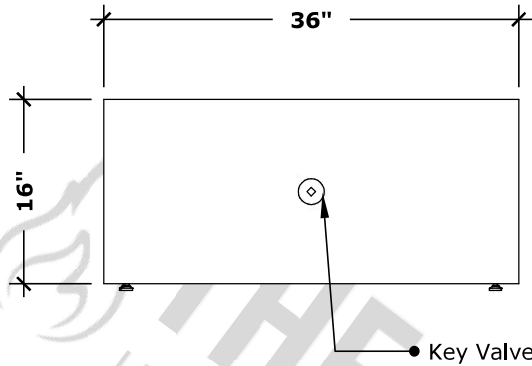

Manufactured By **THE OUTDOOR PLUS**
USA MANUFACTURER OF FIRE & WATER FEATURES



FRONT VIEW

scale: 1/2" = 1'-0" (1:24)

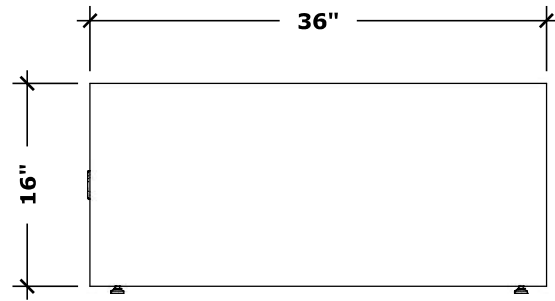

RIGHT VIEW

scale: 1/2" = 1'-0" (1:24)

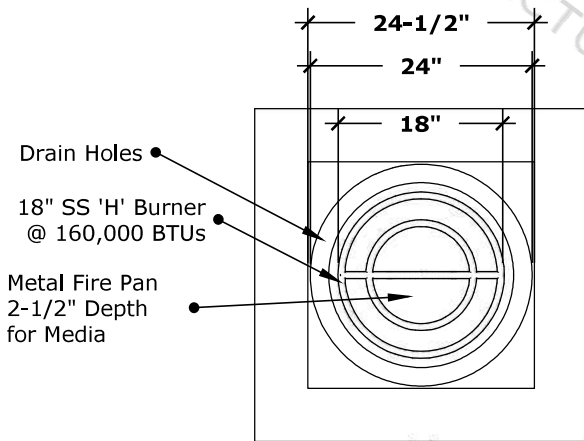

TOP VIEW

scale: 1/2" = 1'-0" (1:24)

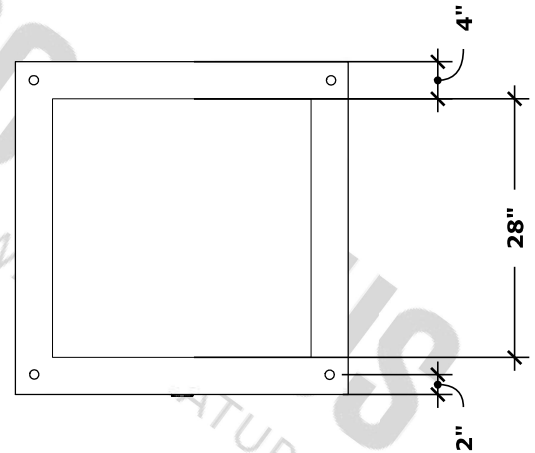

UNDERSIDE VIEW

scale: 1/2" = 1'-0" (1:24)

Fire Pit Material: Copper, Powder Coated Steel, Stainless Steel, or Corten Steel

Pan Material: 316 Stainless Steel

Burner Material: 316 Stainless Steel

Gas Type: Liquid Propane or Natural Gas

Match Lit Unit Includes: Pan, Burner, Gas Orifice, Gas Hoses, Key Valve, Key, & Lava Chunks.

110v Ignition Unit Includes: Pan, Burner, Gas Orifice, Gas Hoses, Key Valve, Key, Plug & Play Electronic Valve, Pilot Igniter.



110V ELECTRONIC IGNITION CERTIFICATION
 ANSI Z21.97-(2017) / CSA 2.41-(2017)