

4

3

2

1

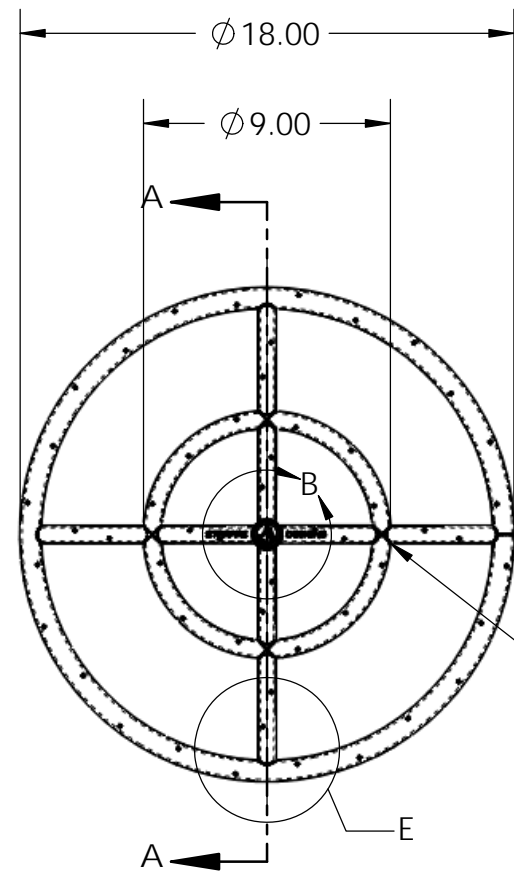

TOP VIEW

1/8" TYP ALL SEAMS
 1/8" TYP ALL JOINTS

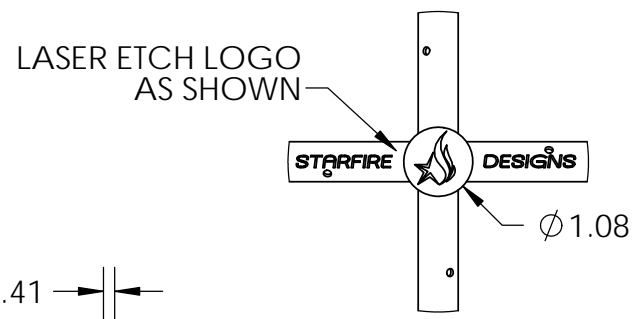

DETAIL B SCALE 1 : 3

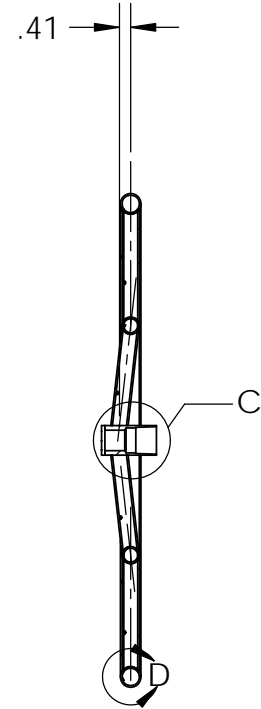

SECTION A-A

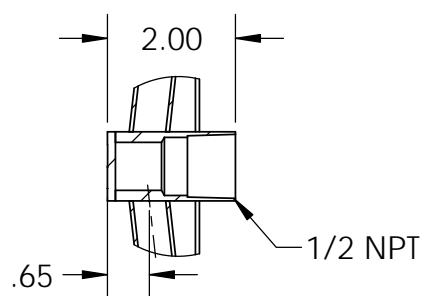

DETAIL C SCALE 1 : 3

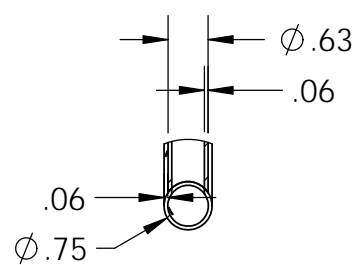

DETAIL D SCALE 1 : 3

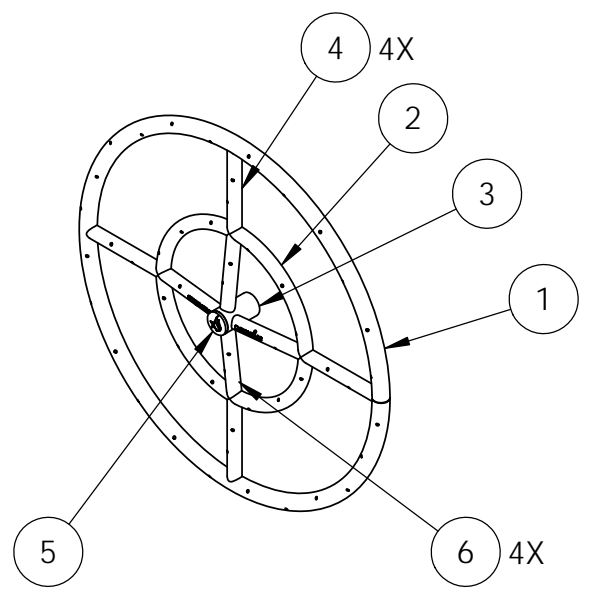

ISOMETRIC VIEW

NOTES:

- ALL DIMENSIONS ARE IN INCHES UNLESS OTHERWISE SPECIFIED.
- MATERIAL: 304SS
- UNIT WEIGHT: _____ LBS
- FOR OUTDOOR USE ONLY

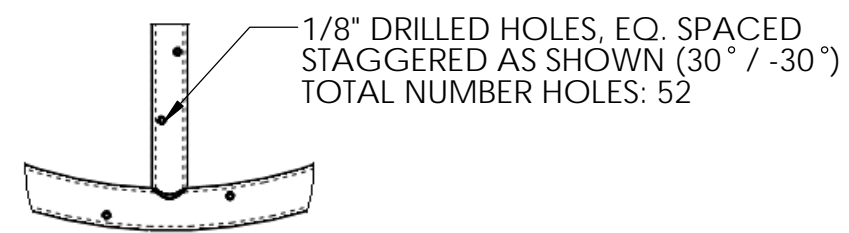

DETAIL E SCALE 2 : 7

1/8" DRILLED HOLES, EQ. SPACED
 STAGGERED AS SHOWN (30° / -30°)
 TOTAL NUMBER HOLES: 52

ITEM NO.	QTY.	DESCRIPTION	LENGTH
6	4	AI RND TUBE 0.625 OD x 0.058 Wall	3.77
5	1	END CAP, 1/8" THK	
4	4	AI RND TUBE 0.625 OD x 0.058 Wall	4.23
3	1	AI RND TUBE 1 OD x 0.095 Wall	1.88
2	1	AI RND TUBE 0.625 OD x 0.058 Wall	26.31
1	1	AI RND TUBE 0.75 OD x 0.058 Wall	54.19

PROPRIETARY AND CONFIDENTIAL
 THE INFORMATION CONTAINED IN THIS DRAWING IS THE SOLE PROPERTY OF STARFIRE DIRECT. ANY REPRODUCTION IN PART OR AS A WHOLE WITHOUT THE WRITTEN PERMISSION OF STARFIRE DIRECT IS PROHIBITED.

UNLESS OTHERWISE SPECIFIED:		NAME	DATE	TITLE:	
DIMENSIONS ARE IN INCHES TOLERANCES: FRACTIONAL ± 1/8" ANGULAR: MACH ± BEND ± TWO PLACE DECIMAL ± THREE PLACE DECIMAL ±		DRAWN		ROUND BURNER Ø 18" OD	
INTERPRET GEOMETRIC TOLERANCING PER:		CHECKED			
MATERIAL 304 SS		ENG APPR.			
FINISH		MFG APPR.			
NEXT ASSY	USED ON	Q.A.		SIZE B	DWG. NO. SD-FR-18
APPLICATION		DO NOT SCALE DRAWING		SCALE: 1:7	WEIGHT:
				REV A	SHEET 1 OF 1

4

3

2

1