

On/Off Bluetooth Control

Models: RF-BTSR1-(B,G)

INSTALLER: Leave these instructions with consumer.
CONSUMER: Retain for future reference.

PARTS LIST

Item	Description	Part No.	Qty.
1.	Bluetooth control w/ wire harness	RF-BTSR1	1
2.	Bluetooth control	BTC-1	1
3.	Bluetooth control wire harness	WH-BT-04	1
4.	Wood chunk (golden oak) or Wood chunk (white birch)	WRC-1 WBC-1	1 1
5.	Harness extension (02 Series w/ remote - G46 02 models only)	WH-BT-02	1
6.	Harness extension (02 Series w/ remote - all other 02 models)	WH-BT-01	1
7.	Harness extension (mSeries - Direct Vent models)	WH-BT-03	1
8.	Insulation tube (set of 2)	INT-01	1
9.	Battery (CR2450 3V) (not shown)	BATTERY-3	1
10.	Velcro strip	-	1
11.	Zip tie (not shown)	-	2



TABLE OF CONTENTS

Note: When viewing electronically, click on any section (blue hyperlink) to advance to it.

PARTS LIST	1
GETTING STARTED.....	3
<i>PRODUCT SPECIFICATIONS</i>	3
<i>VERIFY COMPATIBILITY</i>	3
<i>INSTALL BURNER SYSTEM / DIRECT VENT</i>	3
INSTALLATION AND BURNER CONFIGURATION.....	4
<i>INSTALL/REPLACE BATTERY</i>	4
<i>INSTALL BLUETOOTH CONTROL AND CONFIGURE BURNER</i>	4
APP SETUP	33
<i>CREATE AN ACCOUNT</i>	33
<i>CREATE AN INITIAL ZONE</i>	34
<i>ADD YOUR DEVICE</i>	34
<i>SETUP COMPLETE</i>	35
<i>FORGOT PASSWORD</i>	35
OPERATION	36
<i>BEFORE USE</i>	36
<i>TURNING ON THE BURNER</i>	36
<i>TURNING OFF THE BURNER</i>	36
<i>SETTINGS</i>	37
<i>ADDING, EDITING, DELETING A NEW ZONE OR DEVICE</i>	38
<i>LOGGING OUT</i>	38
TROUBLESHOOTING	39
<i>INSTALLATION OR APP USE ISSUES</i>	39
<i>TECHNICAL APP ISSUES</i>	39
<i>BURNER SYSTEM ISSUES</i>	39
NOTES PAGE	40

GETTING STARTED

PRODUCT SPECIFICATIONS

Note: This bluetooth device can only be controlled by one phone/tablet at a time.

Description	Specification
Dimensions	1.693" L x 1.29" W x .66"
Input voltage	3.0v (1 x CR2450 Coin Cell)
Operating temperature	0-50C (32F - 122F)
Bluetooth broadcast range	up to 10m / 30ft (line of sight)
Communications protocol	Bluetooth 4.0 LE
Warranty	24 months

Table 1 - Product Specifications

VERIFY COMPATIBILITY

This bluetooth control is compatible with select Real Fyre burner systems and electronic devices. See Table 2 and Table 3.

Note: Select models require a new harness extension to complete installation. The harnesses are included; use if needed for your setup. See the [PARTS LIST](#) for details.

Series	Burner Systems
	Vented
02	G22, G31, G45, G46, GR47, G52, PB, EPK-2, EPK-2M-AD
10	EC
11	G31, G45, G46, PB
	Unvented
12	G8E, G9, G10, G18, G19, G21
	Direct Vent
mSERIES	DVI

Table 2 - Burner System Compatibility

Electronic Device	Software Version	Models
Apple iPhone	iOS 10 & above	iPhone 5 & above
Apple iPad	2nd generation	iPad, iPad Mini, & iPad Pro
Android devices	Android 4.4 & above	All Android devices

Table 3 - Electronic Device Compatibility

INSTALL BURNER SYSTEM / DIRECT VENT

If not already done, follow the instruction manual(s) provided with your unit for proper installation. Be sure to shut off the gas supply once complete.

Then proceed to the following [INSTALLATION AND BURNER CONFIGURATION](#) section.

Videos and additional information are available online to assist with installation, app setup, and app operation.

Visit www.realfyre.com/bluetooth-control/ or simply scan the QR code on the right.



INSTALLATION AND BURNER CONFIGURATION

INSTALL/REPLACE BATTERY

Note: It is recommended to insert the battery after wire installation, and just prior to placing the wood chunk / locating the bluetooth control in the fireplace.

The supplied battery must be installed. Locate the bluetooth control. Gently pry open the control using a small and thin flathead screwdriver or similar. Then insert the 3V battery, **ensuring the positive side (+) is facing up as shown.**

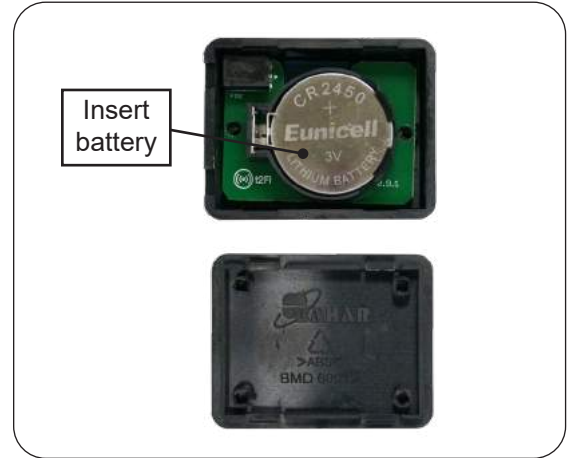

INSTALL BLUETOOTH CONTROL AND CONFIGURE BURNER

The bluetooth control requires installation to the burner, and the burner must be configured to be ready for use via the App. Locate the appropriate section for your particular unit:

Note: When viewing electronically, click on any section (blue hyperlink) to advance to it.

BURNER SYSTEMS	5
10,11, OR 12 VALVE: MANUAL SETUP	5
10,11, OR 12 VALVE: REMOTE SETUP	9
02 VALVE (G46 ONLY): MANUAL SETUP	13
02 VALVE (G46 ONLY): REMOTE SETUP	17
02 VALVE (COMMON): MANUAL SETUP	21
02 VALVE (COMMON): REMOTE SETUP	25
DIRECT VENT	29
DIRECT VENT MILLIVOLT (MSERIES) SETUP	29

10,11, or 12 valve: Manual Setup

Follow the steps on the next 3 pages to install the bluetooth control, and configure the burner for app use.

A wiring diagram is also available below for quick reference.

For a video on setup, visit www.realfyre.com/bluetooth-control/ and locate your model (as listed above).

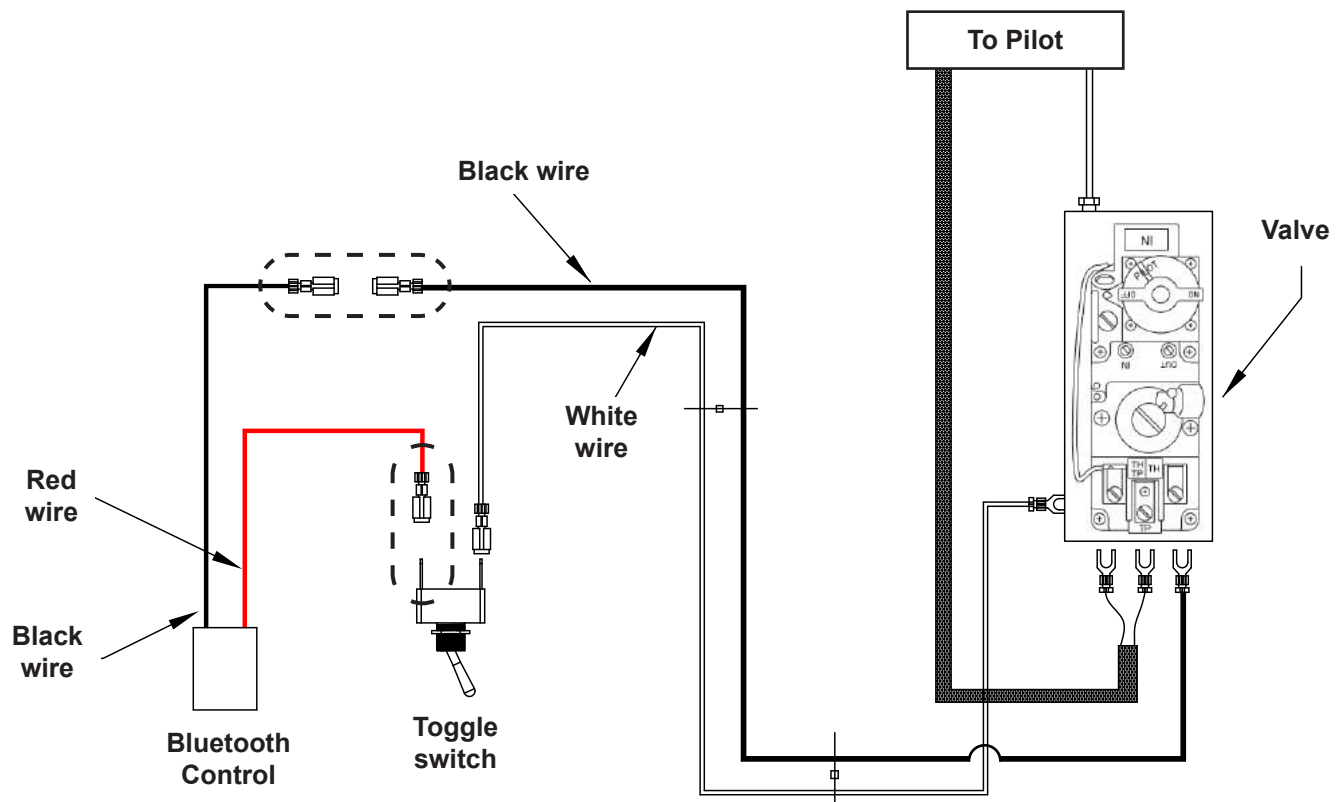

INSTALLATION AND BURNER CONFIGURATION (Cont.)

G45 burner with 11 valve shown - design may vary, installation is the same.

Disconnect black wire (and remove connector)

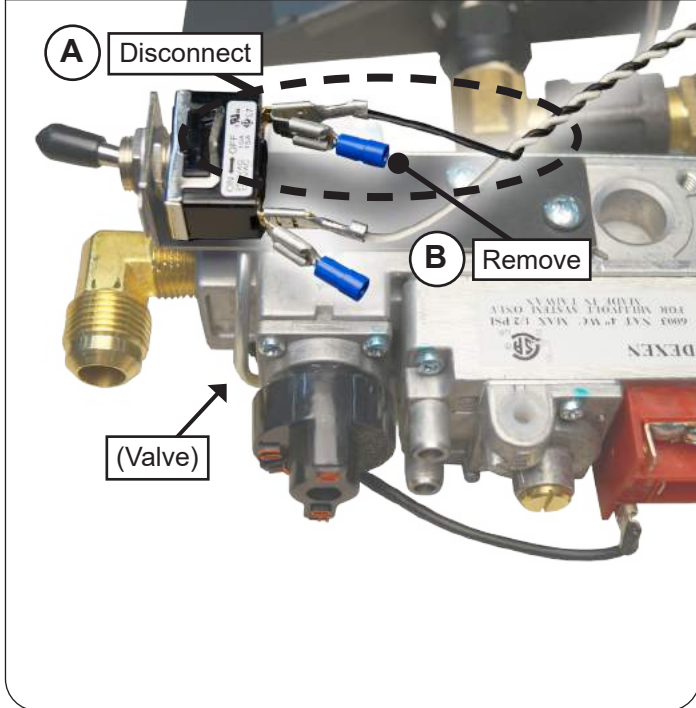

Plug wire harness into bluetooth control, put insulation on red wire



Connect red wire to switch on valve

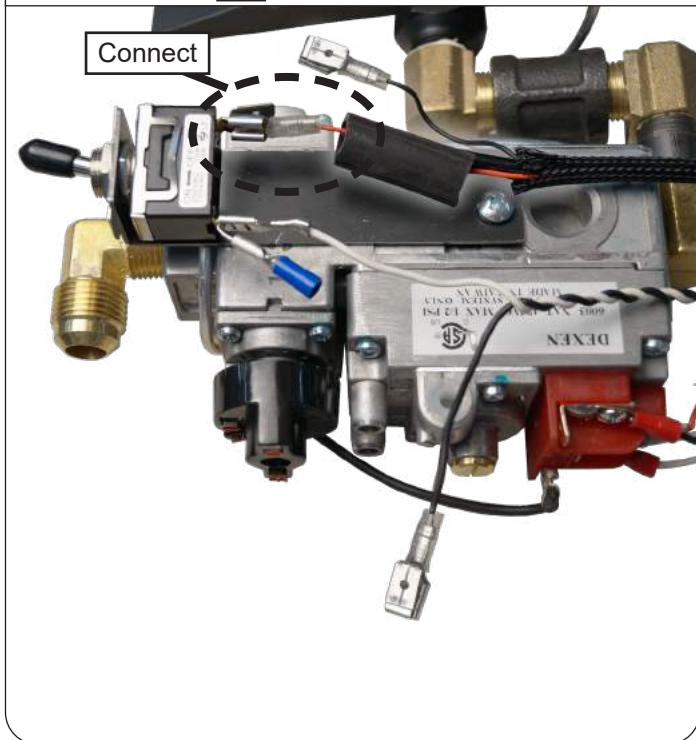

Slide insulation in place, connect valve black wire onto tab of bluetooth control black wire

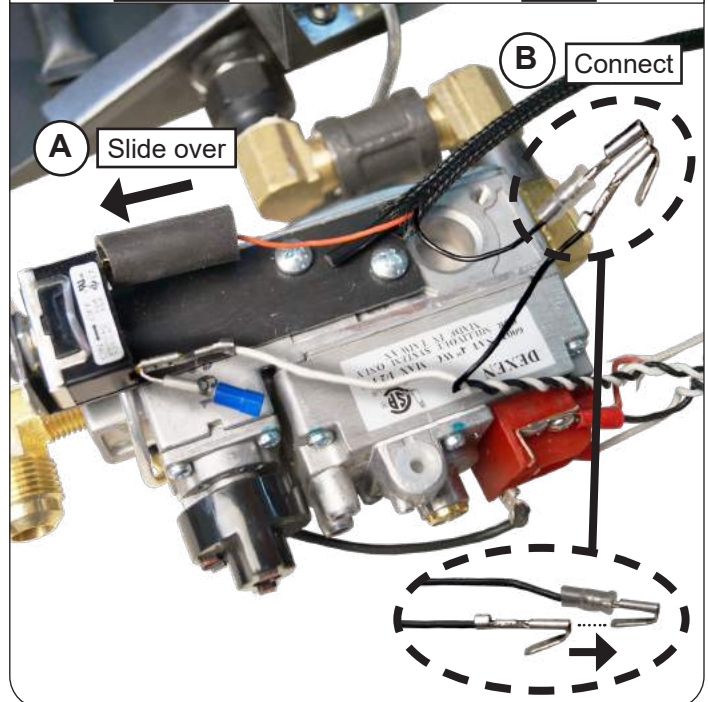

Installation continued on next page

INSTALLATION AND BURNER CONFIGURATION (Cont.)

Put insulation on new connection

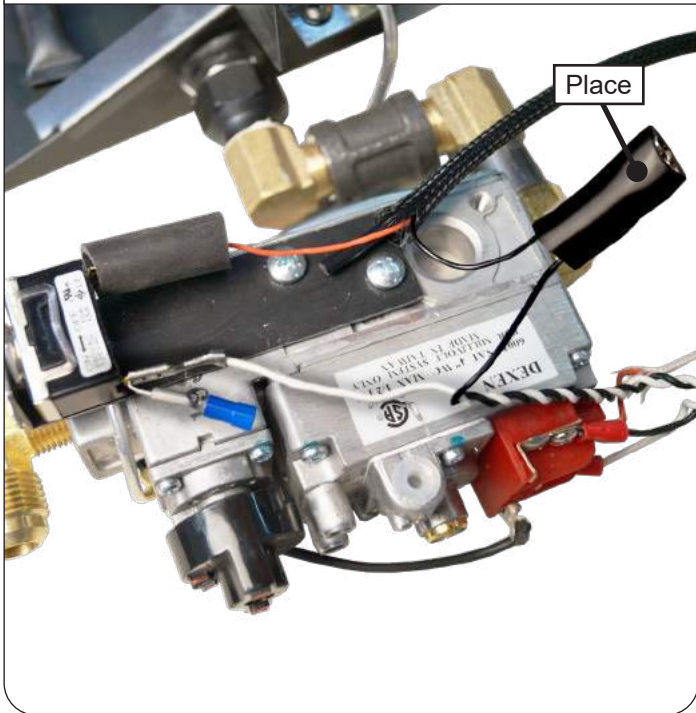

Secure assembly (to red wire) using zip tie

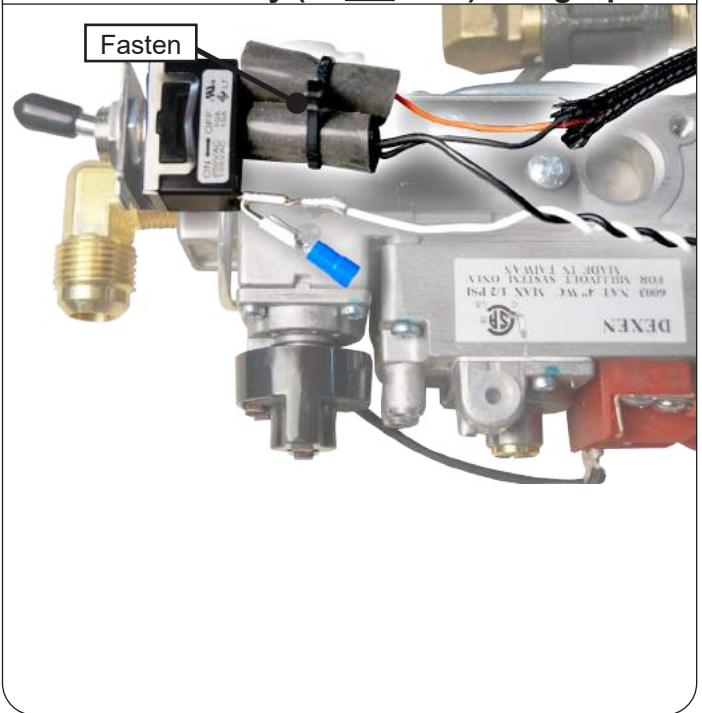

Place valve heat shield and wood chunk

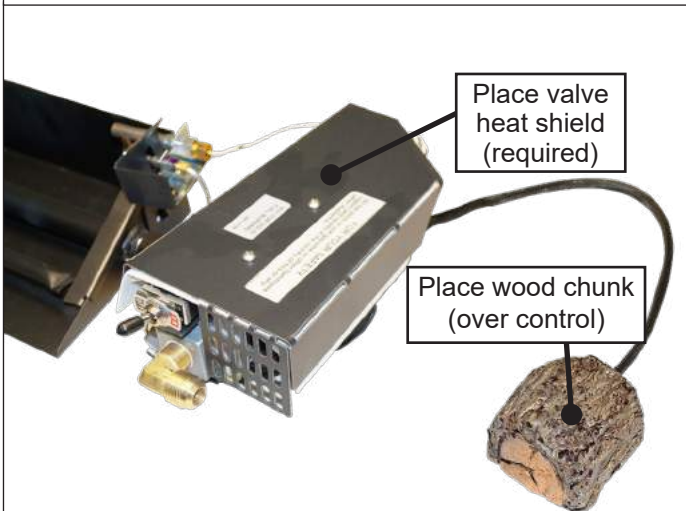

- The valve heat shield **MUST** be placed.
- See next figure for details on bluetooth control location, and wood chunk requirements.
- **Reminder:** ensure the battery is installed at this stage. Refer to the [INSTALL/REPLACE BATTERY](#) section.

Put control in an appropriate location

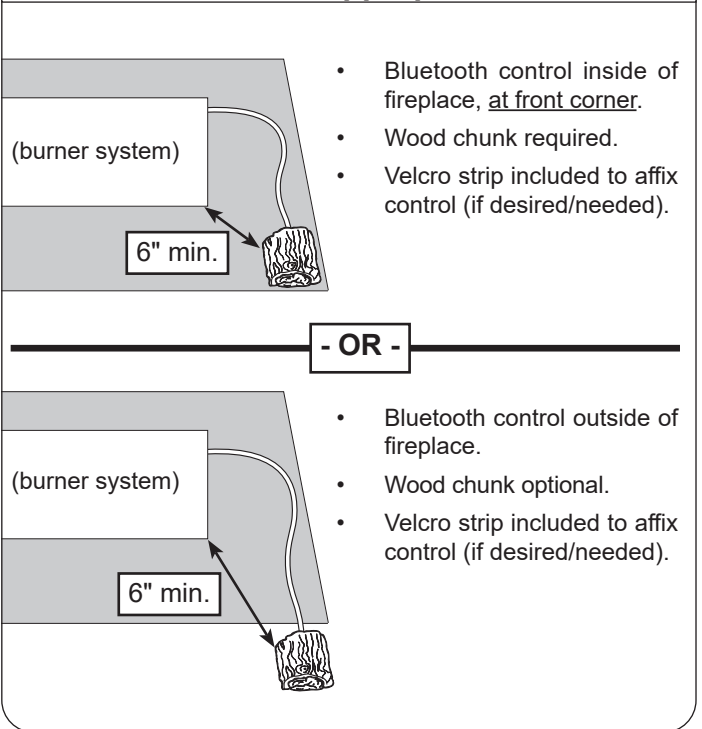

**Continue to next page for details on setting burner system to proper positions.
(To allow for use of remote app.)**

CONFIGURE BURNER FOR APP USE:

Refer to the LIGHTING INSTRUCTIONS in the burner owner's manual, ensuring that:

- the gas supply is turned back on
- the pilot is lit
- the valve is in the ON position
- the toggle switch is in the ON position

Note: This configuration does not allow for the burner to be manually lit via the toggle switch. The app must be used. If you desire original functionality to manually turn the unit on and off, disconnect the bluetooth control and return the wire connections to their original setup.

Installation is complete. Go to the [APP SETUP](#) section.

10,11, or 12 valve: Remote Setup

Follow the steps on the next 3 pages to install the bluetooth control, and configure the burner for app use.

A wiring diagram is also available below for quick reference.

For a video on setup, visit www.realfyre.com/bluetooth-control/ and locate your model (as listed above).

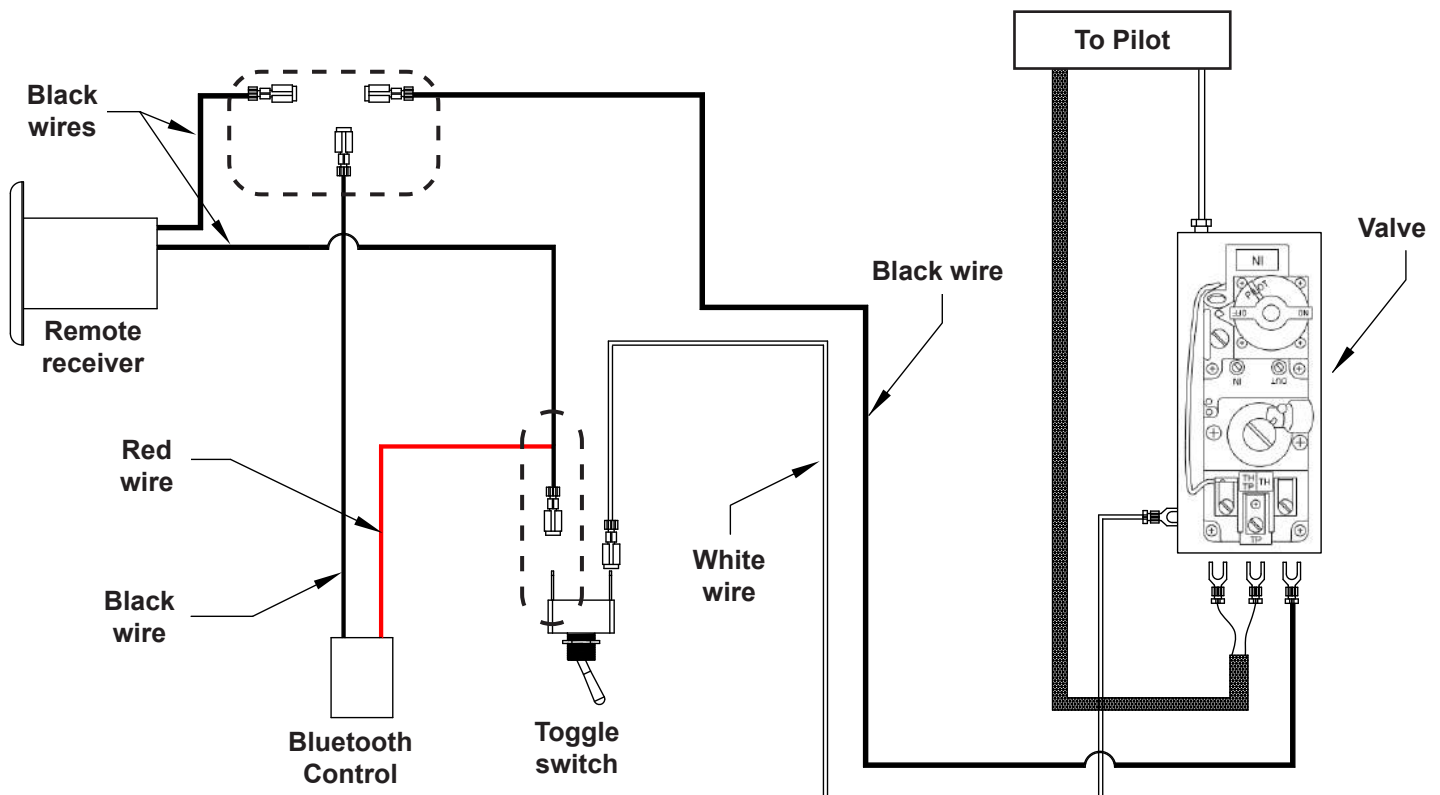

INSTALLATION AND BURNER CONFIGURATION (Cont.)

G45 burner with 11 valve shown - design may vary, installation is the same.

Disconnect black wire (and remove connector)

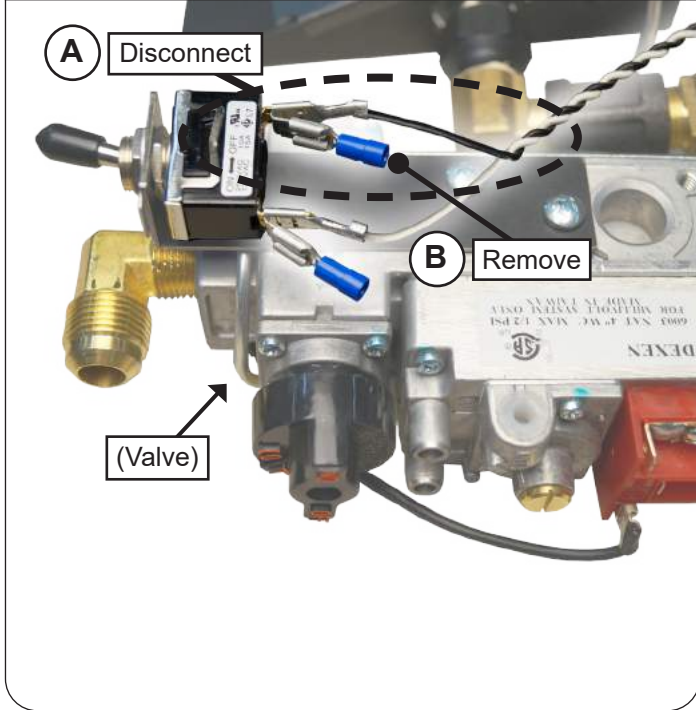

Plug wire harness, connect bluetooth control red wire onto tab of remote receiver black wire

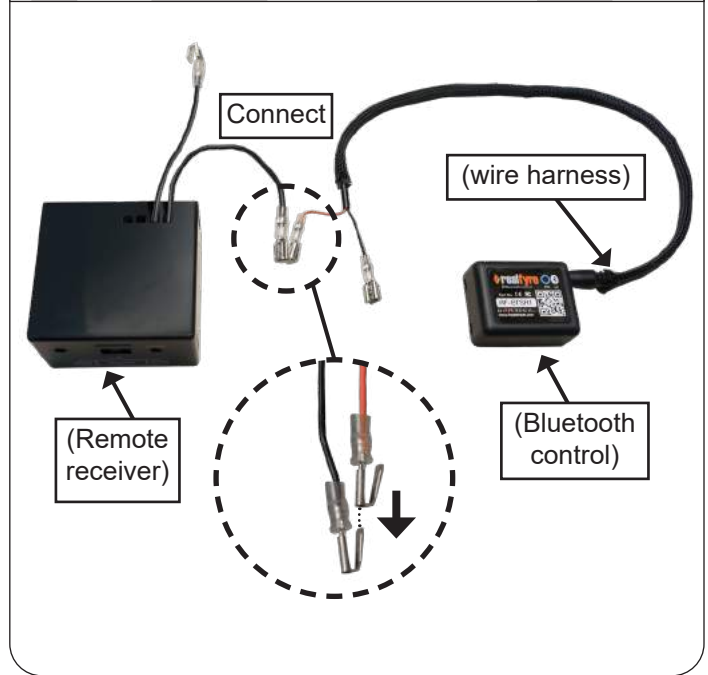

Put insulation on new connection

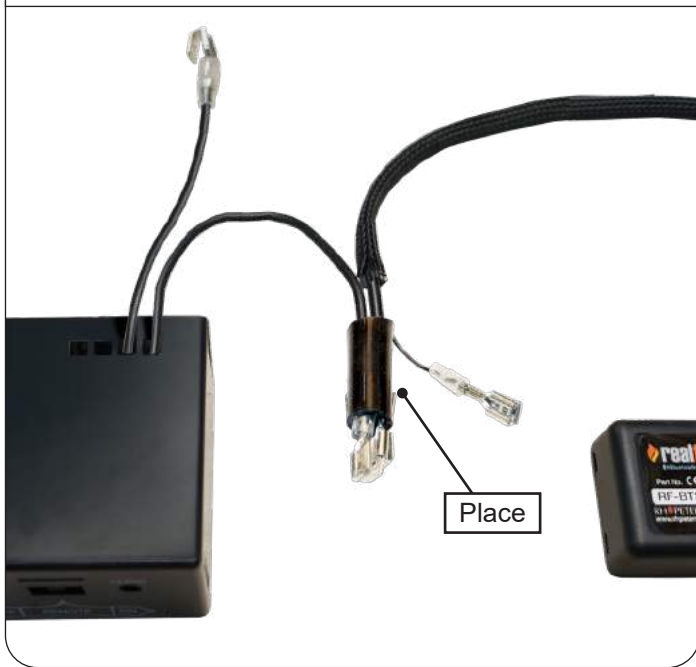

Connect assembly to switch on valve, slide insulation in place

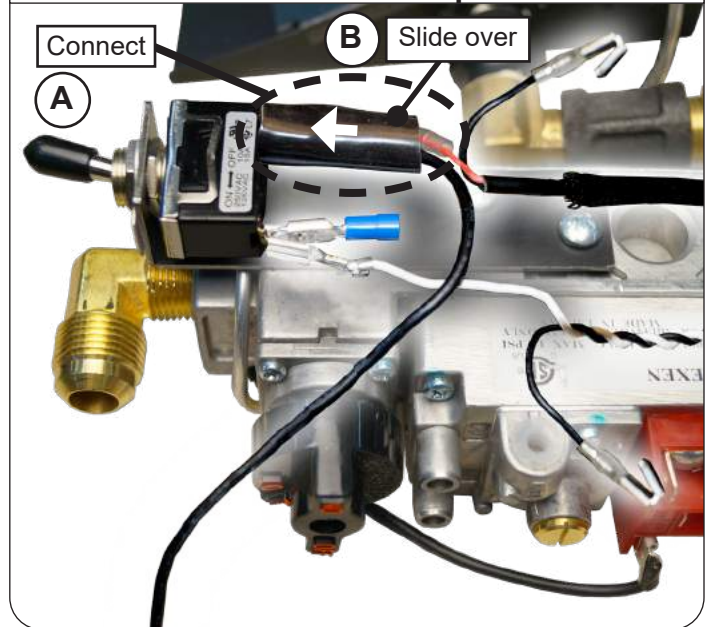

Installation continued on next page

INSTALLATION AND BURNER CONFIGURATION (Cont.)

Connect 3 exposed black wires from:
valve, bluetooth control, and remote receiver

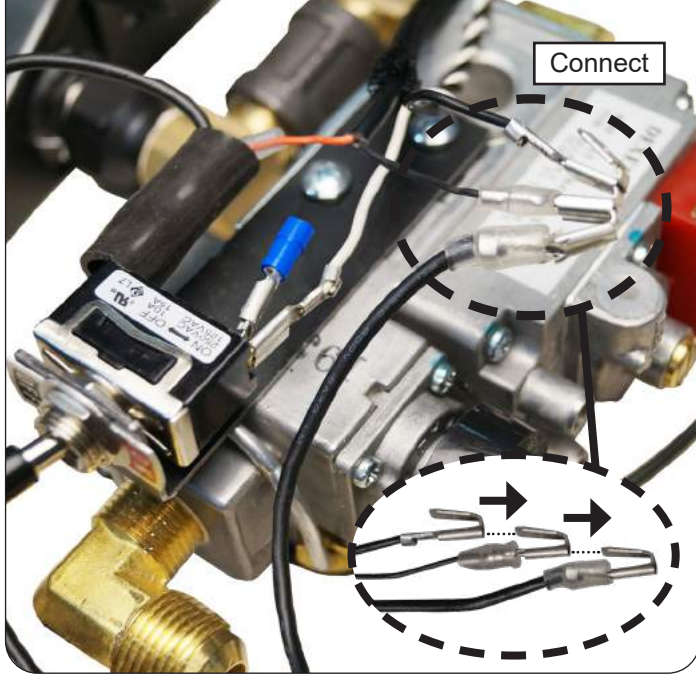

Put insulation on new connection

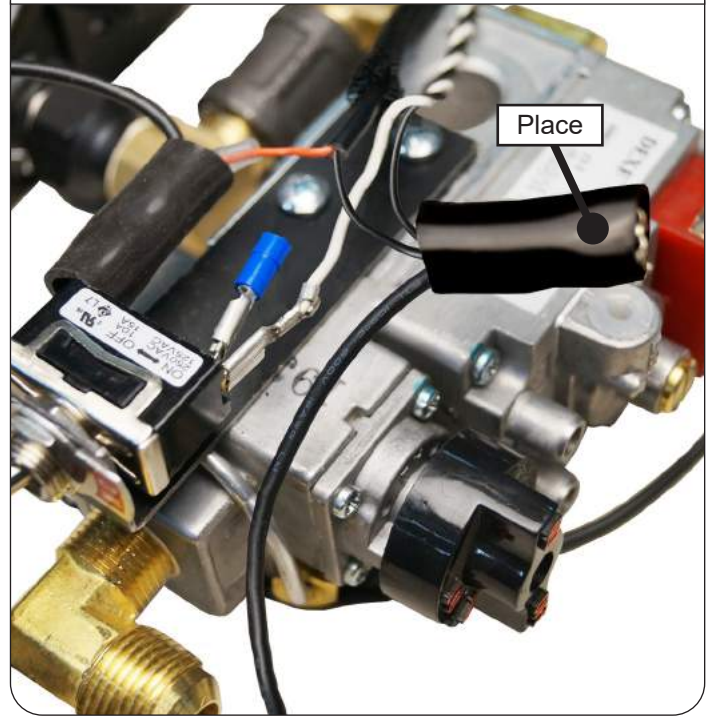

Secure assembly (to white wire) using zip tie



Installation continued on next page

INSTALLATION AND BURNER CONFIGURATION (Cont.)

Place heat shields and wood chunk

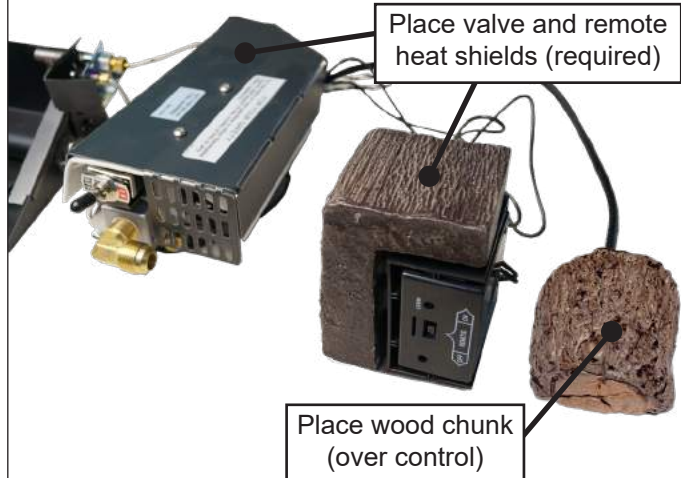

- The valve and remote heat shields **MUST** be placed.
- See next figure for details on bluetooth control location, and wood chunk requirements.
- **Reminder:** ensure the battery is installed at this stage. Refer to the [INSTALL/REPLACE BATTERY](#) section.
- Follow all instructions in owner's manual included with burner for complete details on proper remote placement.

Put control in an appropriate location

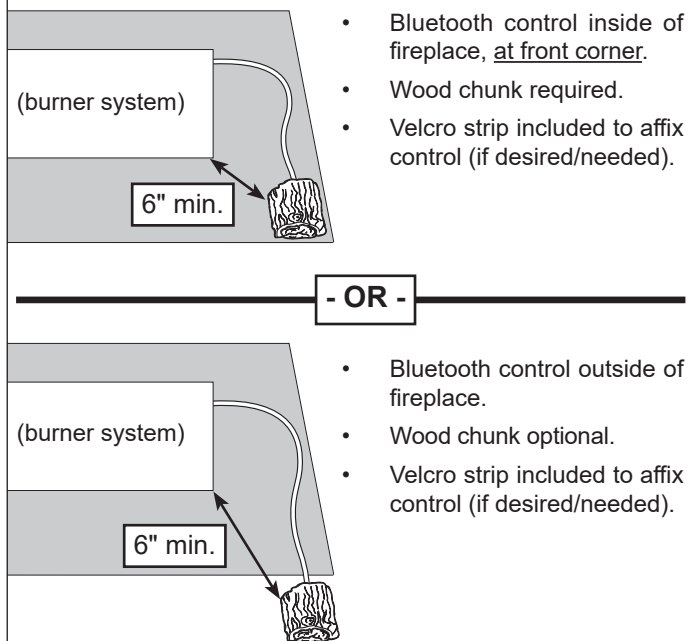

- Bluetooth control inside of fireplace, at front corner.
- Wood chunk required.
- Velcro strip included to affix control (if desired/needed).

- Bluetooth control outside of fireplace.
- Wood chunk optional.
- Velcro strip included to affix control (if desired/needed).

CONFIGURE BURNER FOR APP USE:

Refer to the LIGHTING INSTRUCTIONS in the burner owner's manual, ensuring that:

- the gas supply is turned back on
- the pilot is lit
- the valve is in the ON position
- the toggle switch is in the ON position
- the remote receiver is in the REMOTE position

Note: This configuration does not allow for the burner to be manually lit via the toggle switch. The app must be used. If you desire original functionality to manually turn the unit on and off, disconnect the bluetooth control and return the wire connections to their original setup.

Installation is complete. Go to the [APP SETUP](#) section.

02 valve (G46 Only): Manual Setup

Follow the steps on the next 3 pages to install the bluetooth control, and configure the burner for app use.

A wiring diagram is also available below for quick reference.

For a video on setup, visit www.realfyre.com/bluetooth-control/ and locate your model (as listed above).

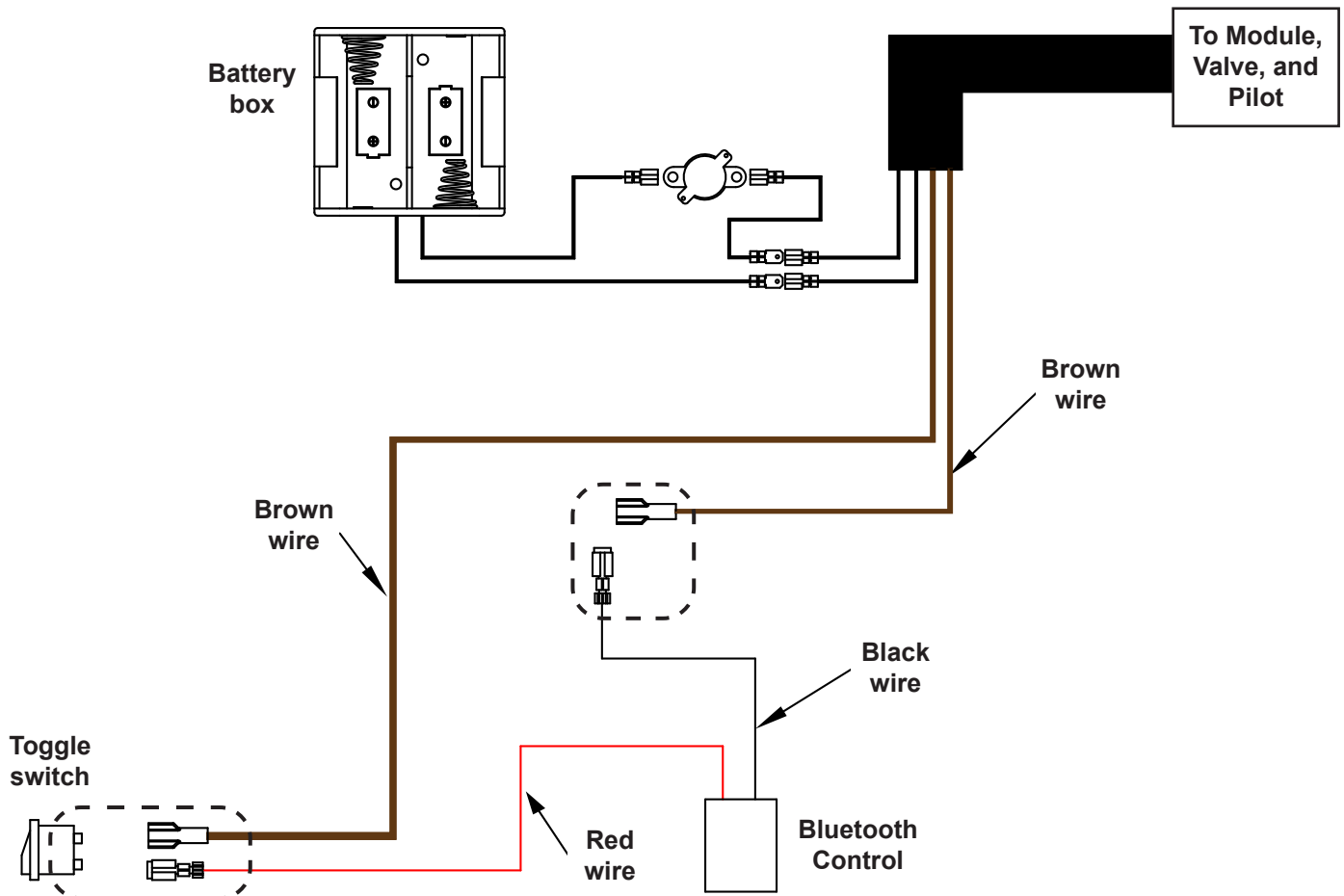

INSTALLATION AND BURNER CONFIGURATION (Cont.)

Important: Ensure batteries are removed prior to beginning.

Disconnect and remove harness

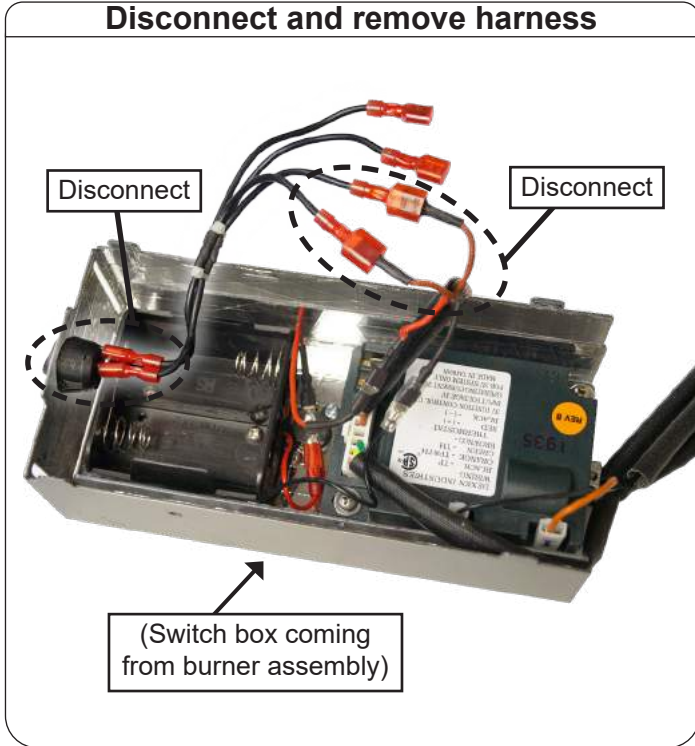

Connect one brown wire to switch

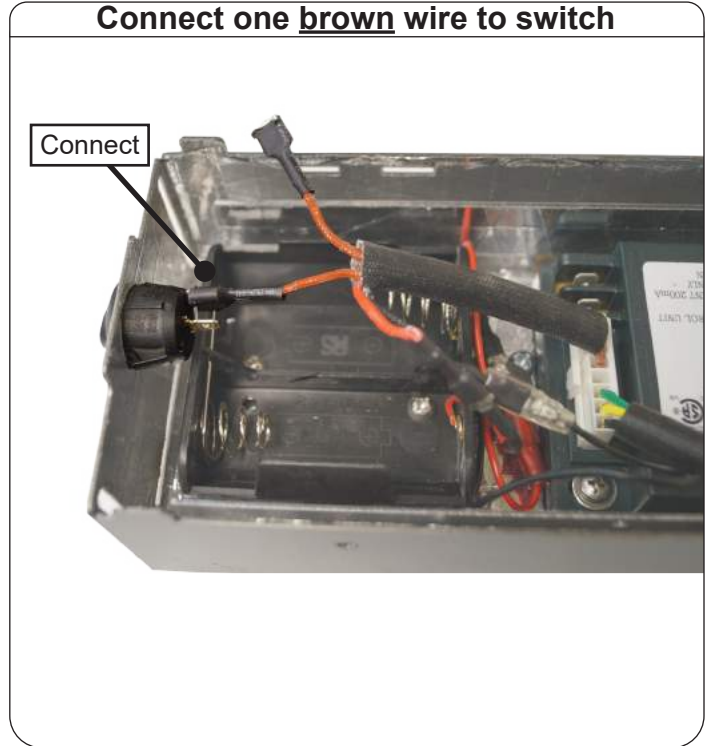

Plug wire harness into bluetooth control, put insulation on red wire

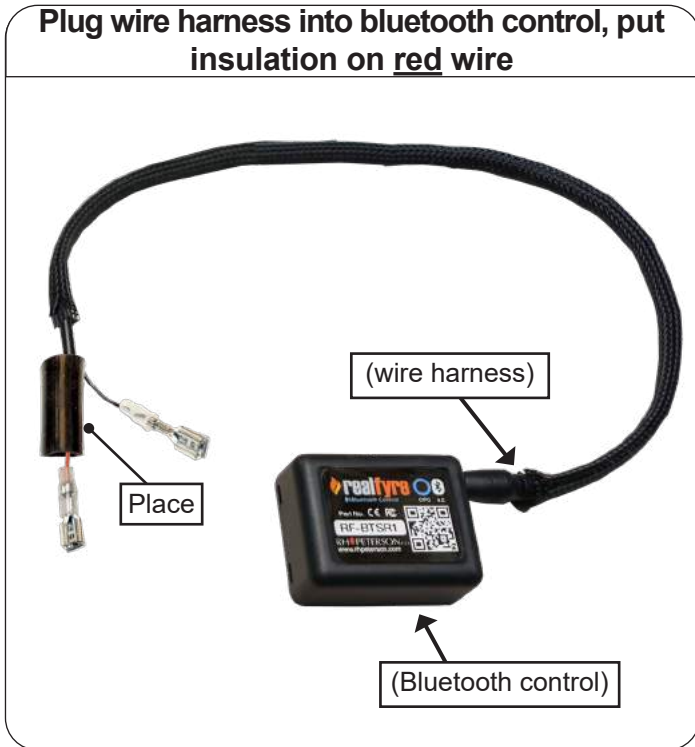

Connect bluetooth control red wire to switch



Installation continued on next page

INSTALLATION AND BURNER CONFIGURATION (Cont.)

Slide insulation in place

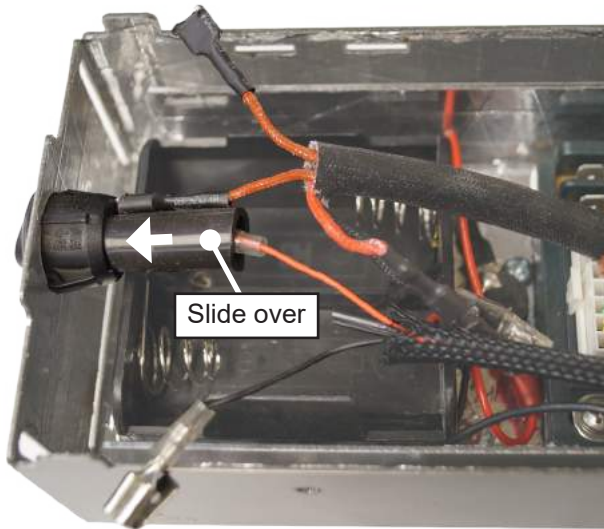

Connect brown wire onto
tab of bluetooth control black wire

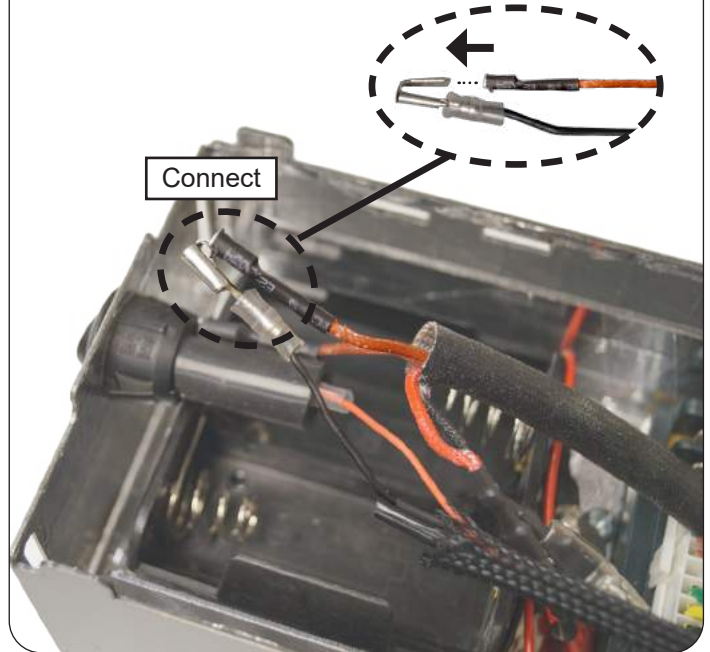

Put insulation on new connection,
position assembly within switch box



Installation continued on next page

INSTALLATION AND BURNER CONFIGURATION (Cont.)

Place switch box heat shield and wood chunk

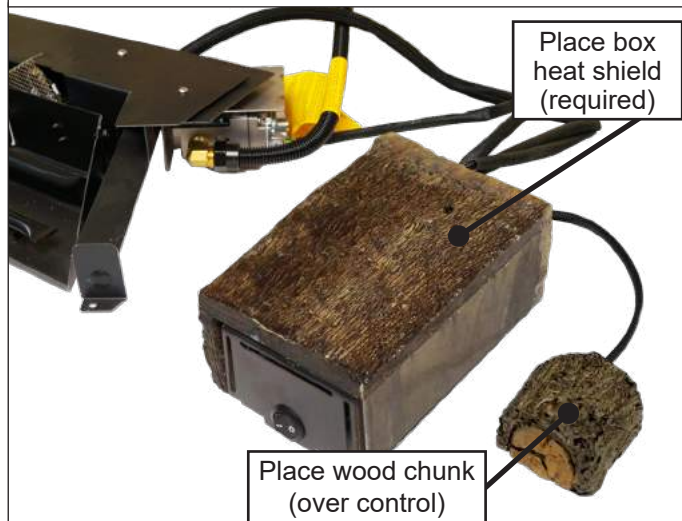

- The switch box heat shield **MUST** be placed.
- See next figure for details on bluetooth control location, and wood chunk requirements.
- Reminder: ensure the control battery is installed at this stage. Refer to the [INSTALL/REPLACE BATTERY](#) section. Also replace the box batteries.
- Follow all instructions in owner's manual included with burner for complete details on proper switch box placement.

Put control in an appropriate location

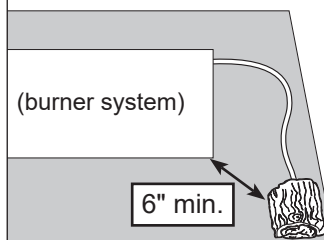

- Bluetooth control inside of fireplace, at front corner.
- Wood chunk required.
- Velcro strip included to affix control (if desired/needed).

- OR -

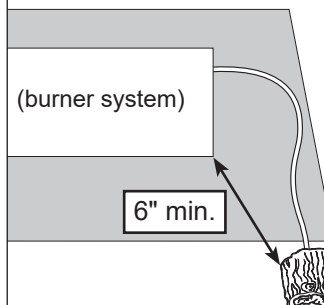

- Bluetooth control outside of fireplace.
- Wood chunk optional.
- Velcro strip included to affix control (if desired/needed).

CONFIGURE BURNER FOR APP USE:

Refer to the LIGHTING INSTRUCTIONS in the burner owner's manual, ensuring that:

- the gas supply is turned back on
- the ON/OFF switch is in the ON position

Note: This configuration does not allow for the burner to be manually lit via the ON/OFF switch. The app must be used. If you desire original functionality to manually turn the unit on and off, disconnect the bluetooth control and return the wire connections to their original setup.

Installation is complete. Go to the [APP SETUP](#) section.

02 valve (G46 Only): Remote Setup

Follow the steps on the next 3 pages to install the bluetooth control, and configure the burner for app use.

A wiring diagram is also available below for quick reference.

For a video on setup, visit www.realfyre.com/bluetooth-control/ and locate your model (as listed above).

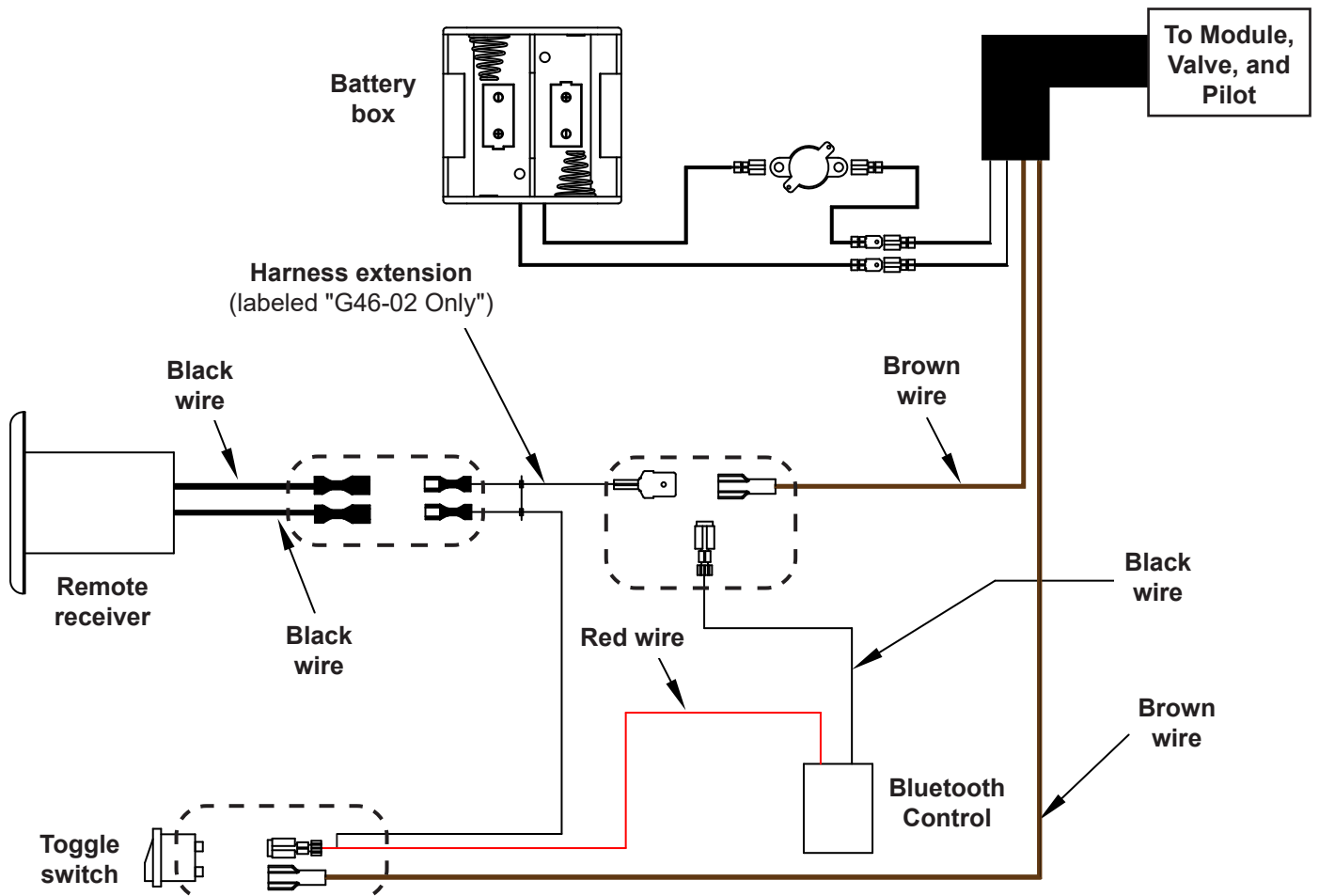

INSTALLATION AND BURNER CONFIGURATION (Cont.)

Important: Ensure batteries are removed prior to beginning.

Note: This model requires a new harness extension (included) to complete installation. See the [PARTS LIST](#), and use the correct extension labeled "G46-02 ONLY".

Disconnect and remove harness

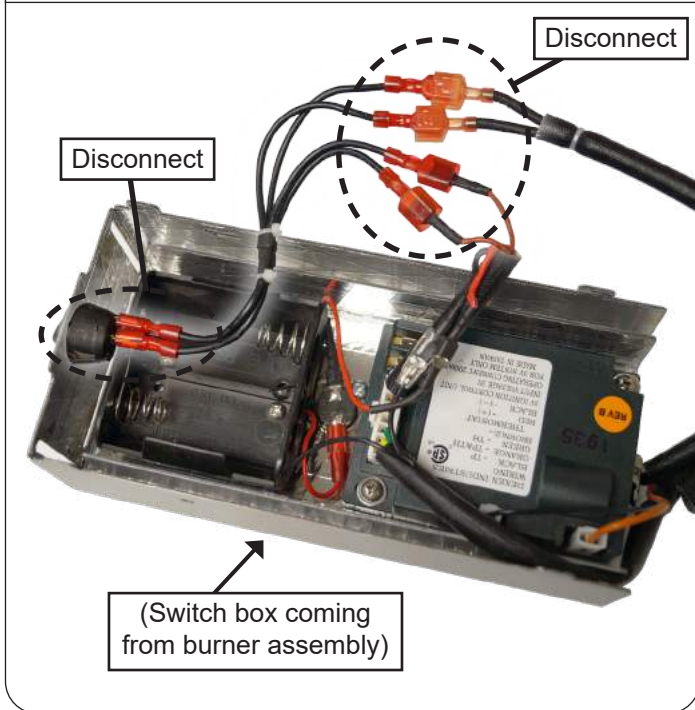

Connect one brown wire to switch

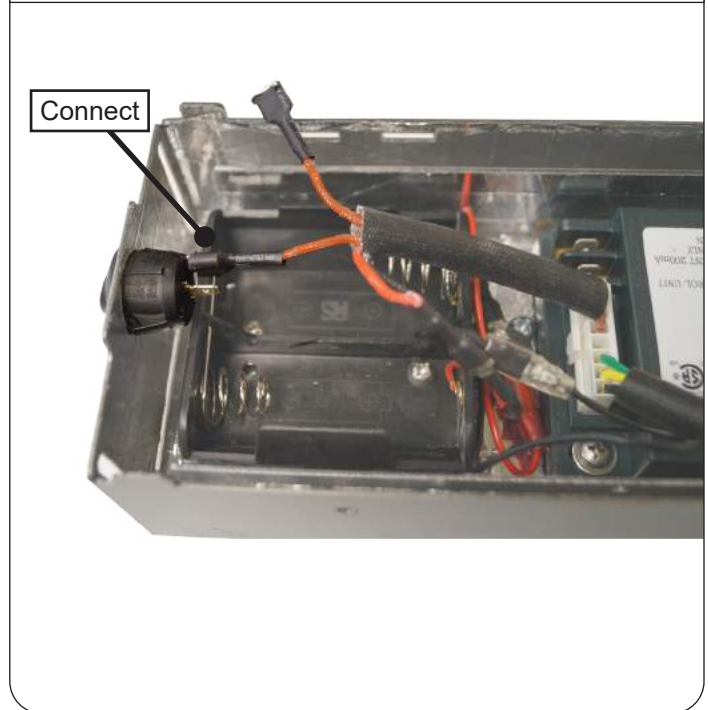

Connect new harness extension (included) to remote receiver wires

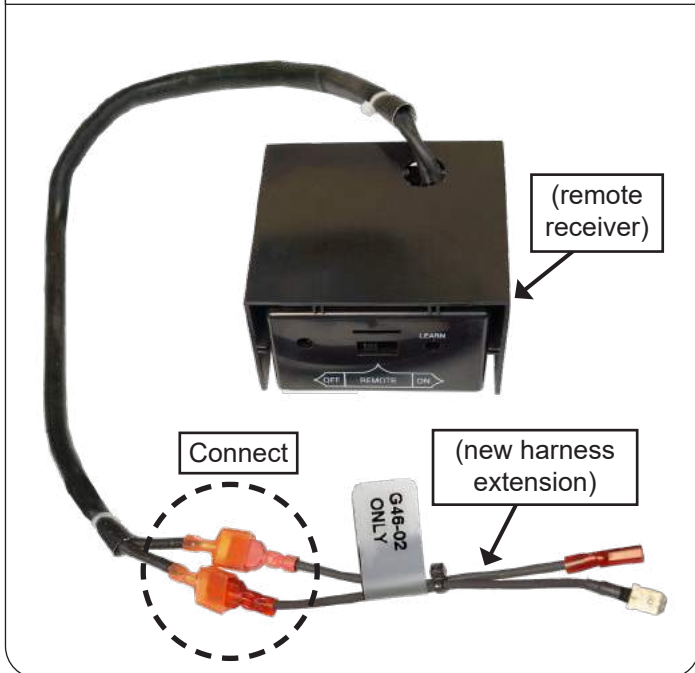

Connect female connector of new harness onto tab of bluetooth control red wire, put on insulation

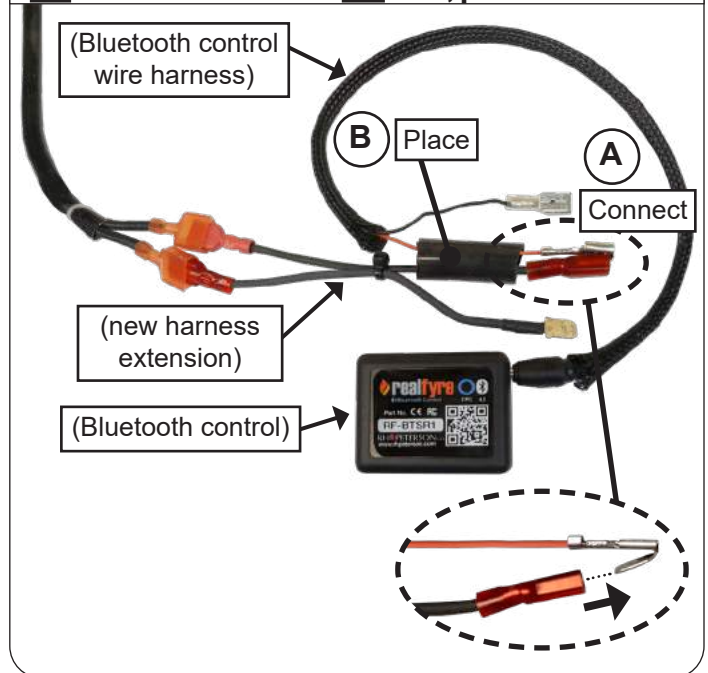

Installation continued on next page

INSTALLATION AND BURNER CONFIGURATION (Cont.)

Connect bluetooth control red wire to switch



Slide insulation, connect brown wire onto tab of bluetooth control wire, put on insulation

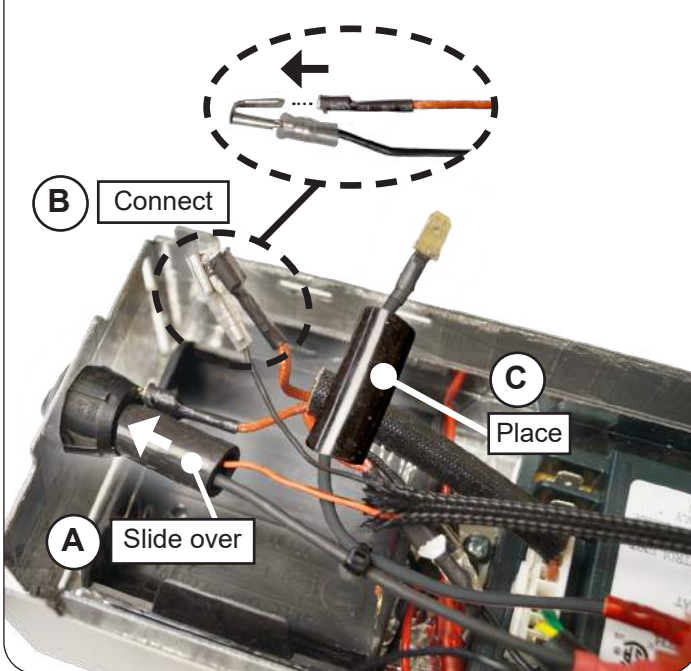

Insert black harness wire into bluetooth control black wire. Then slide insulation over.

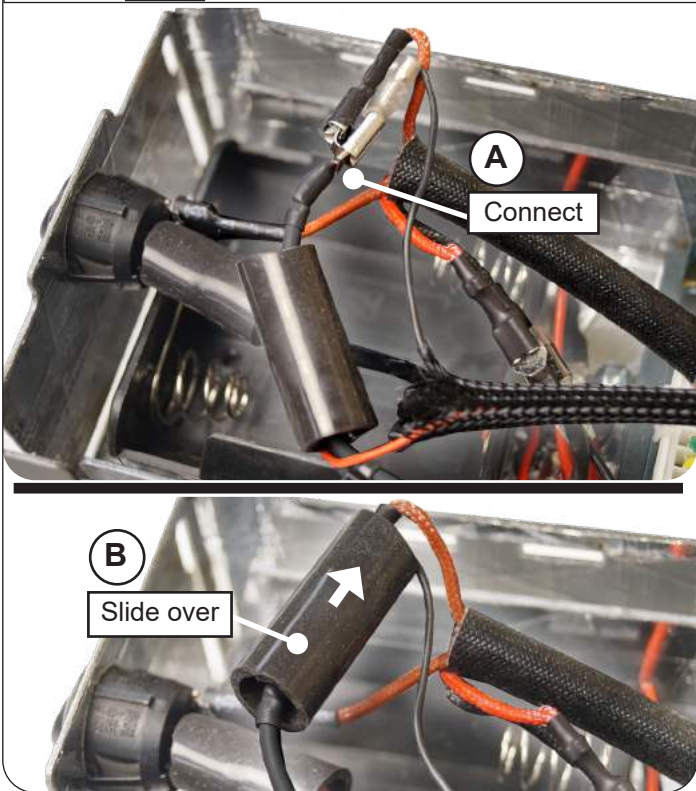

Installation continued on next page

INSTALLATION AND BURNER CONFIGURATION (Cont.)

Place heat shields and wood chunk

Place box and remote heat shields (required)

Note: Remote placed on left side - see instructions



- The box and remote heat shields **MUST** be placed.
- See next figure for details on bluetooth control location, and wood chunk requirements.
- Reminder: ensure the control battery is installed at this stage. Refer to the [INSTALL/REPLACE BATTERY](#) section. Also replace the box batteries.
- Follow all instructions in owner's manual included with burner for complete details on proper switch box and remote placement.

Put control in an appropriate location

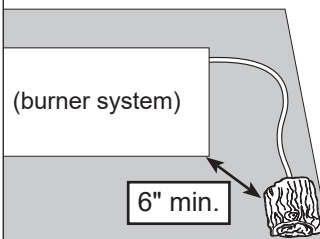

- Bluetooth control inside of fireplace, at front corner.
- Wood chunk required.
- Velcro strip included to affix control (if desired/needed).

- OR -

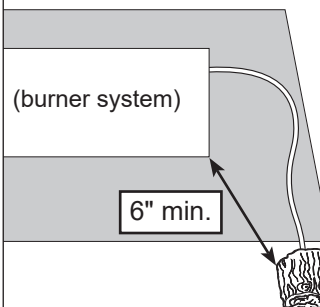

- Bluetooth control outside of fireplace.
- Wood chunk optional.
- Velcro strip included to affix control (if desired/needed).

CONFIGURE BURNER FOR APP USE:

Refer to the LIGHTING INSTRUCTIONS in the burner owner's manual, ensuring that:

- the gas supply is turned back on
- the remote receiver is in the REMOTE position.
- IN ADDITION, flip the ON/OFF switch to the ON position.

Note: This configuration does not allow for the burner to be manually lit via the ON/OFF switch. The app must be used. If you desire original functionality to manually turn the unit on and off, disconnect the bluetooth control and return the wire connections to their original setup.

Installation is complete. Go to the [APP SETUP](#) section.

02 valve (Common): Manual Setup

Follow the steps on the next 3 pages to install the bluetooth control, and configure the burner for app use.

A wiring diagram is also available below for quick reference.

For a video on setup, visit www.realfyre.com/bluetooth-control/ and locate your model (as listed above).

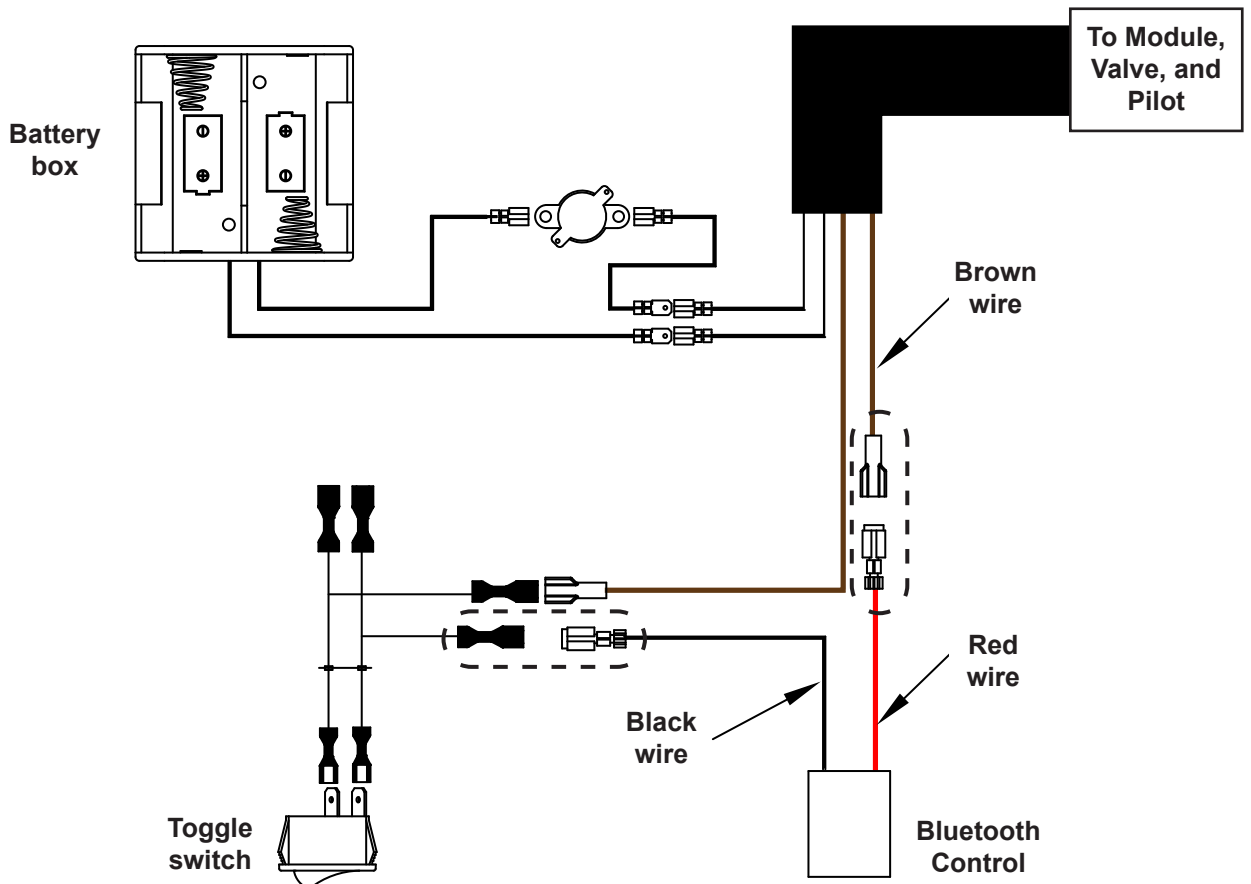

INSTALLATION AND BURNER CONFIGURATION (Cont.)

Important: Ensure batteries are removed prior to beginning.

Disconnect one brown wire from switch harness

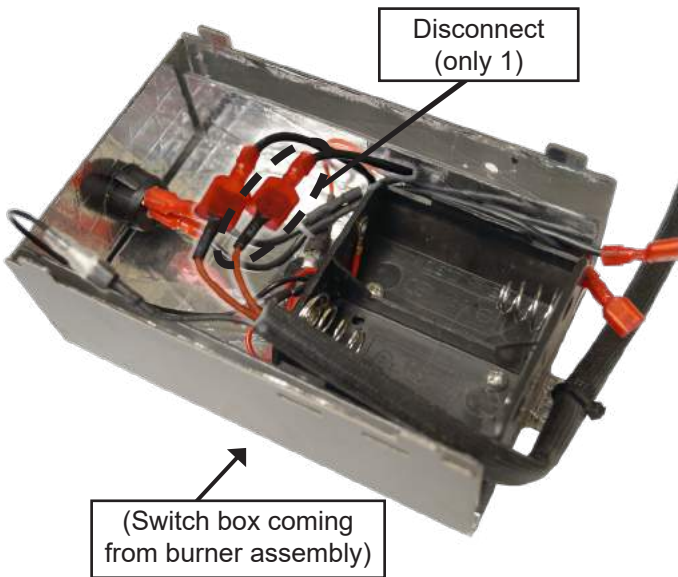

Plug wire harness into bluetooth control, connect switch harness wire to black wire

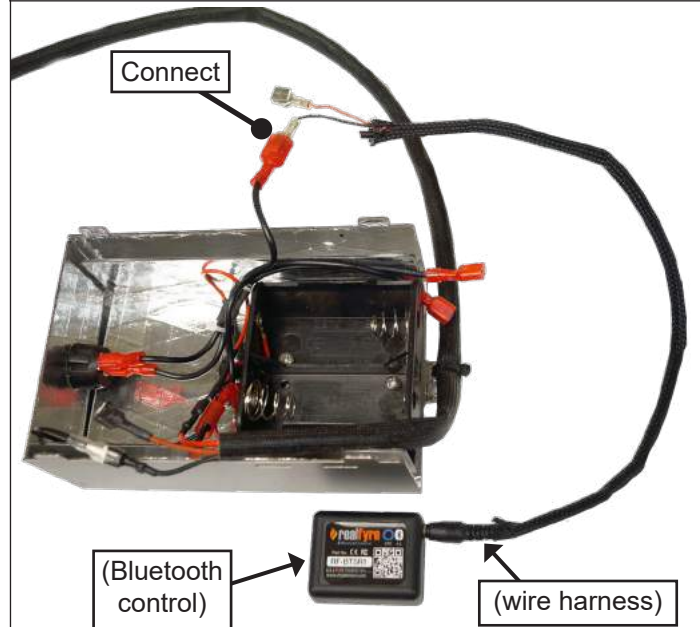

Connect brown wire onto tab of bluetooth control red wire

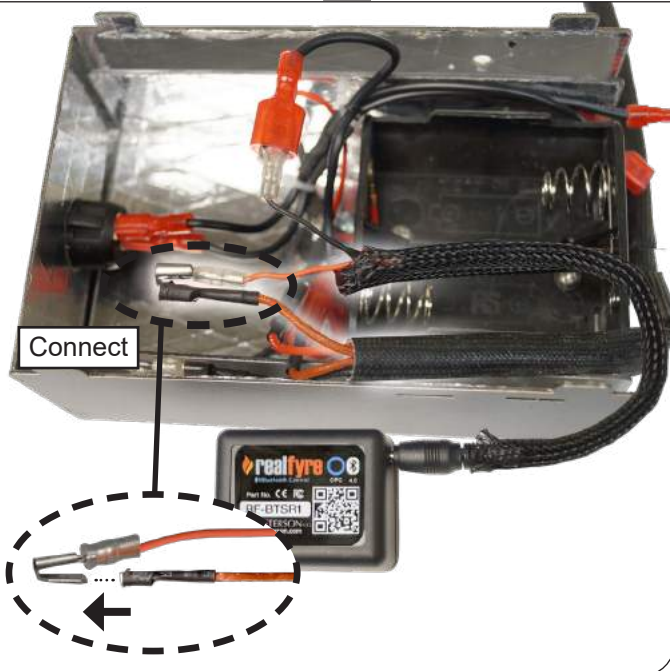

Put insulation on new connection



Installation continued on next page

INSTALLATION AND BURNER CONFIGURATION (Cont.)

Place heat shields and wood chunk

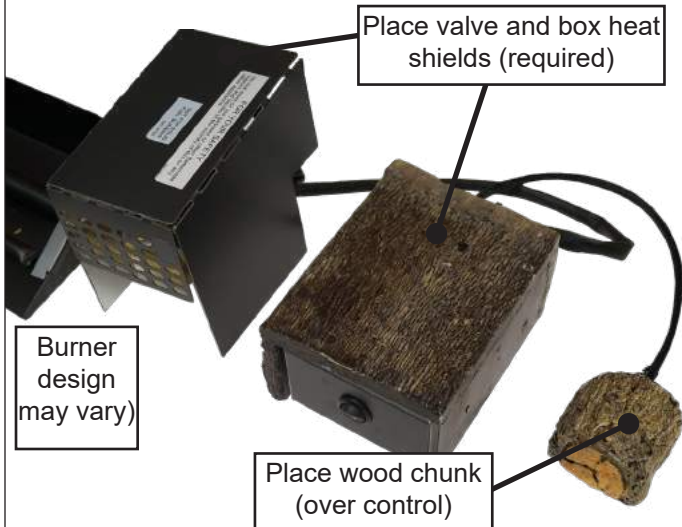

- The valve and switch box heat shields **MUST** be placed.
- See next figure for details on bluetooth control location, and wood chunk requirements.
- Reminder: ensure the control battery is installed at this stage. Refer to the [INSTALL/REPLACE BATTERY](#) section. Also replace the box batteries.
- Follow all instructions in owner's manual included with burner for complete details on proper switch box placement.

Put control in an appropriate location

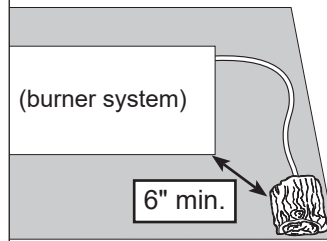

- Bluetooth control inside of fireplace, **at front corner.**
- Wood chunk required.
- Velcro strip included to affix control (if desired/needed).

- OR -

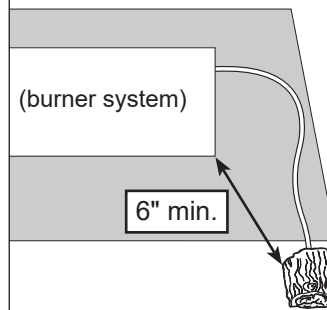

- Bluetooth control outside of fireplace.
- Wood chunk optional.
- Velcro strip included to affix control (if desired/needed).

**Continue to next page for details on setting burner system to proper positions.
(To allow for use of remote app.)**

CONFIGURE BURNER FOR APP USE:

Refer to the LIGHTING INSTRUCTIONS in the burner owner's manual, ensuring that:

- the gas supply is turned back on
- the ON/OFF switch is in the ON position

Note: This configuration does not allow for the burner to be manually lit via the ON/OFF switch. The app must be used. If you desire original functionality to manually turn the unit on and off, disconnect the bluetooth control and return the wire connections to their original setup.

Installation is complete. Go to the [APP SETUP](#) section.

02 valve (Common): Remote Setup

Follow the steps on the next 3 pages to install the bluetooth control, and configure the burner for app use.

A wiring diagram is also available below for quick reference.

For a video on setup, visit www.realfyre.com/bluetooth-control/ and locate your model (as listed above).

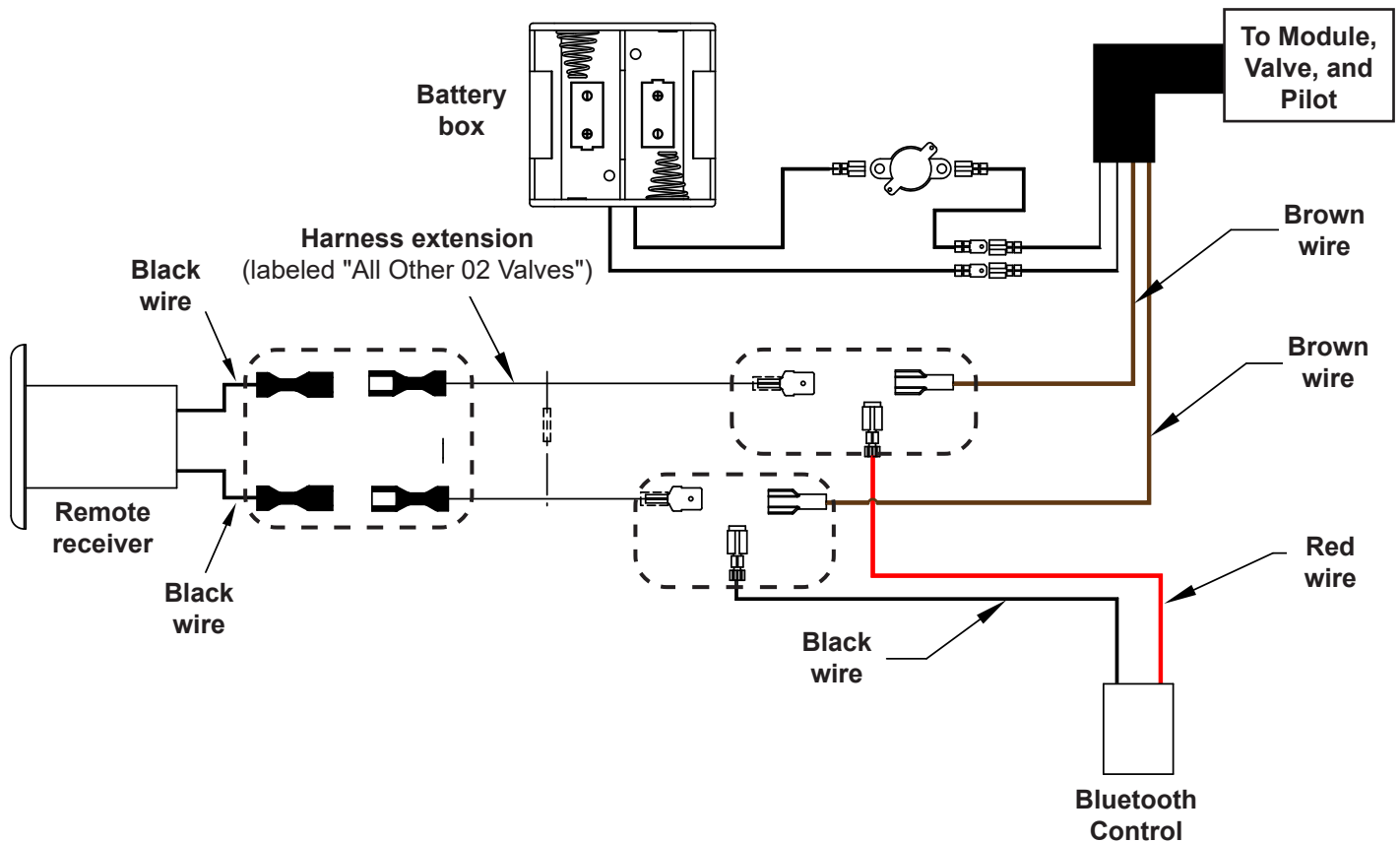

INSTALLATION AND BURNER CONFIGURATION (Cont.)

Important: Ensure batteries are removed prior to beginning.

Note: This model requires a new harness extension (included) to complete installation. See the [PARTS LIST](#), and use the correct extension labeled "ALL OTHER 02 VALVES".

Disconnect two brown wires from remote receiver wires

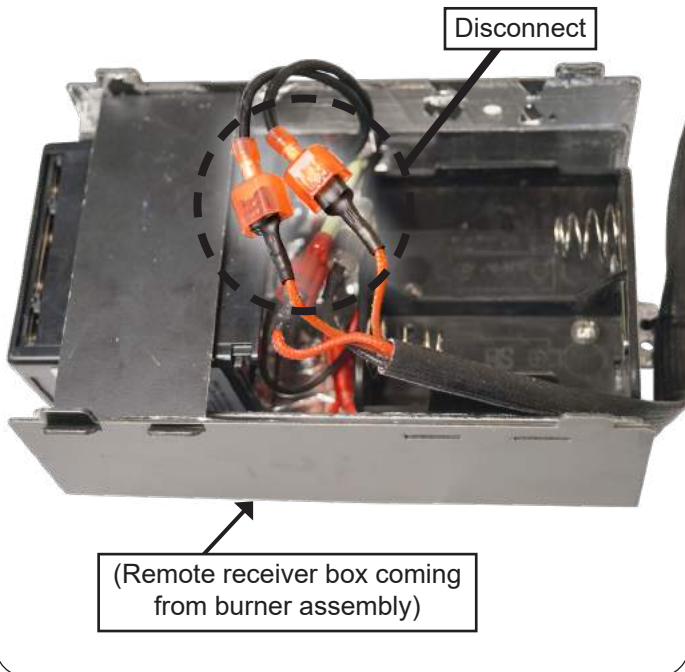

Connect new harness extension (included) to remote receiver wires

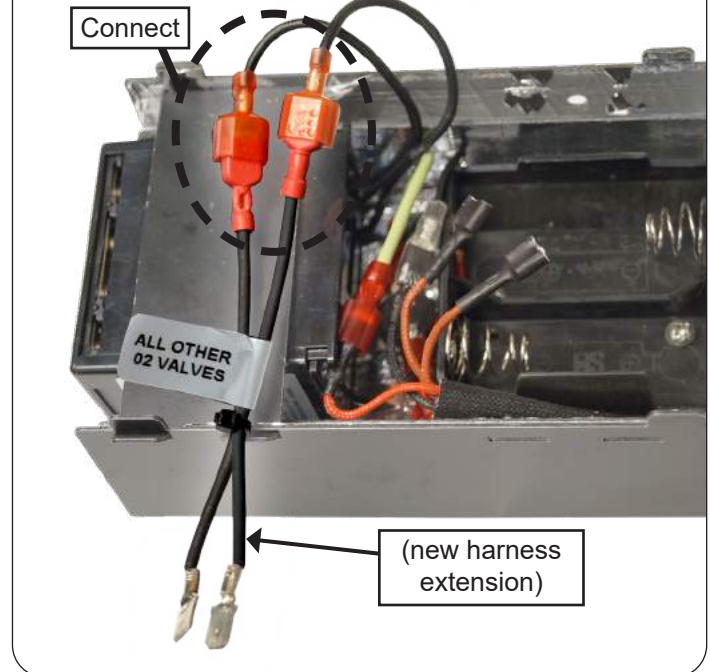

Connect brown wires onto tabs of bluetooth control red and black wires

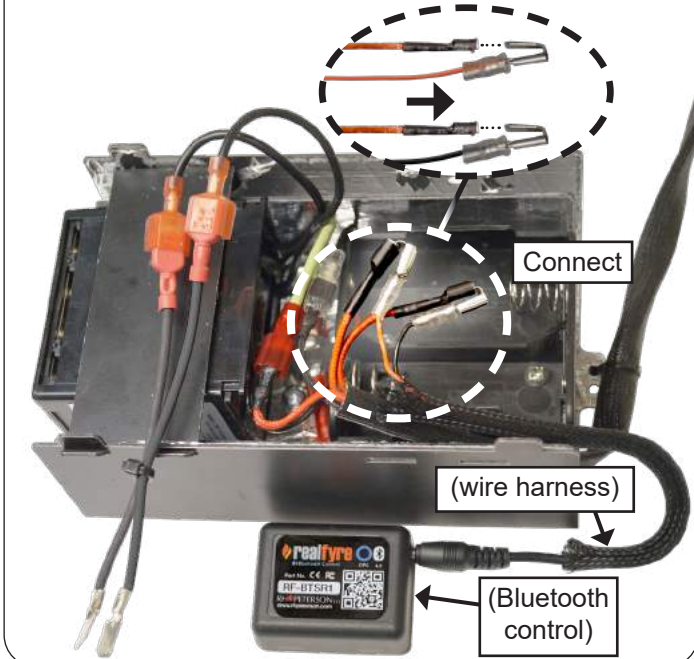

Put insulation tubes on new harness



Installation continued on next page

INSTALLATION AND BURNER CONFIGURATION (Cont.)

Insert harness extension wires into bluetooth control wires

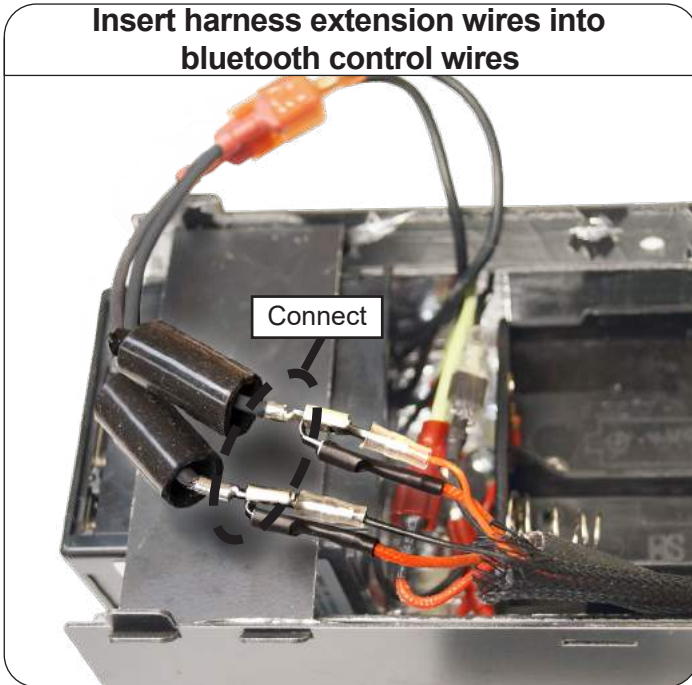

Slide insulation tubes in place

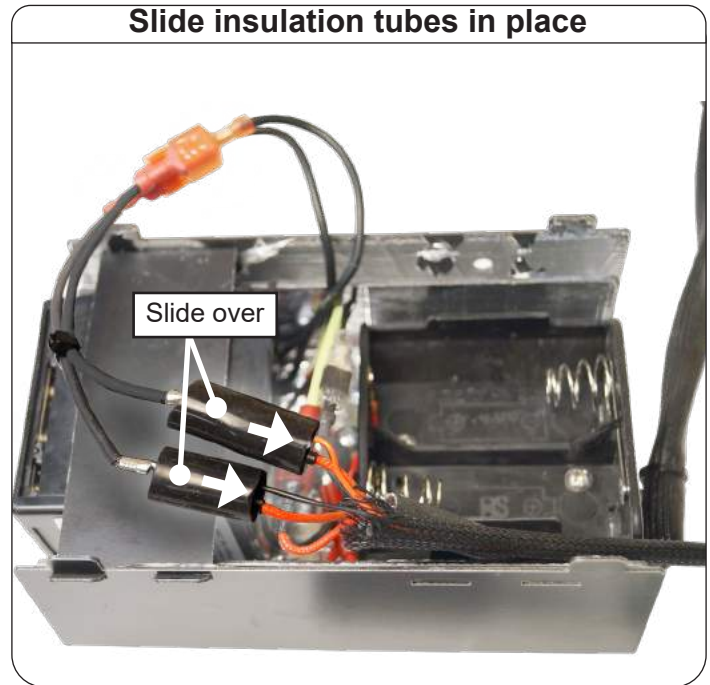

Place heat shields and wood chunk

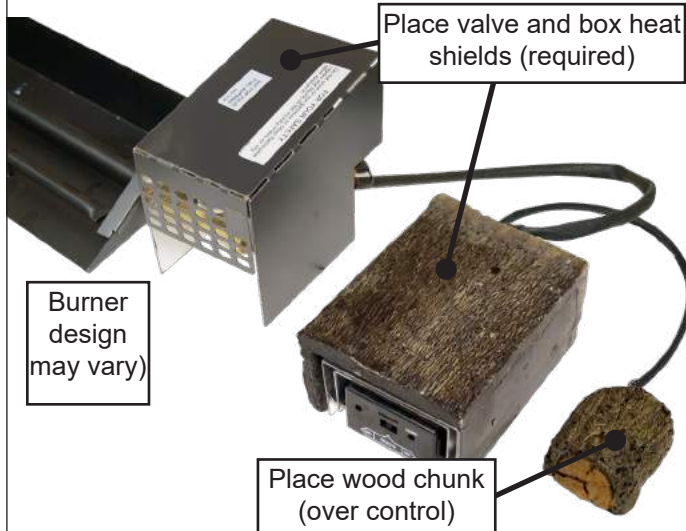

- The valve and remote receiver box heat shields **MUST** be placed.
- See next figure for details on bluetooth control location, and wood chunk requirements.
- Reminder: ensure the control battery is installed at this stage. Refer to the [INSTALL/REPLACE BATTERY](#) section. Also replace the box batteries.
- Follow all instructions in owner's manual included with burner for complete details on proper remote receiver box placement.

Put control in an appropriate location

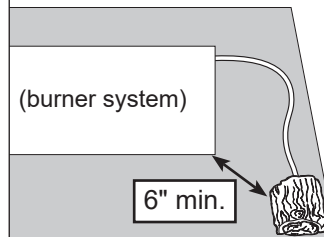

- Bluetooth control inside of fireplace, **at front corner**.
- Wood chunk required
- Velcro strip included to affix control (if desired/needed).

- OR -

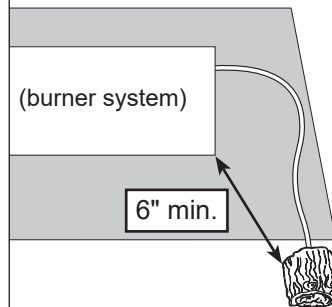

- Bluetooth control outside of fireplace.
- Wood chunk optional.
- Velcro strip included to affix control (if desired/needed).

**Continue to next page for details on setting burner system to proper positions.
(To allow for use of remote app.)**

CONFIGURE BURNER FOR APP USE:

Refer to the LIGHTING INSTRUCTIONS in the burner owner's manual, ensuring that:

- the gas supply is turned back on
- the remote receiver is in the REMOTE position.

Installation is complete. Go to the [APP SETUP](#) section.

Direct Vent Millivolt (mSeries) Setup

Follow the steps on the next 3 pages to install the bluetooth control, and configure the burner for app use.

A wiring diagram is also available below for quick reference.

For a video on setup, visit www.realfyre.com/bluetooth-control/ and locate your model (as listed above).

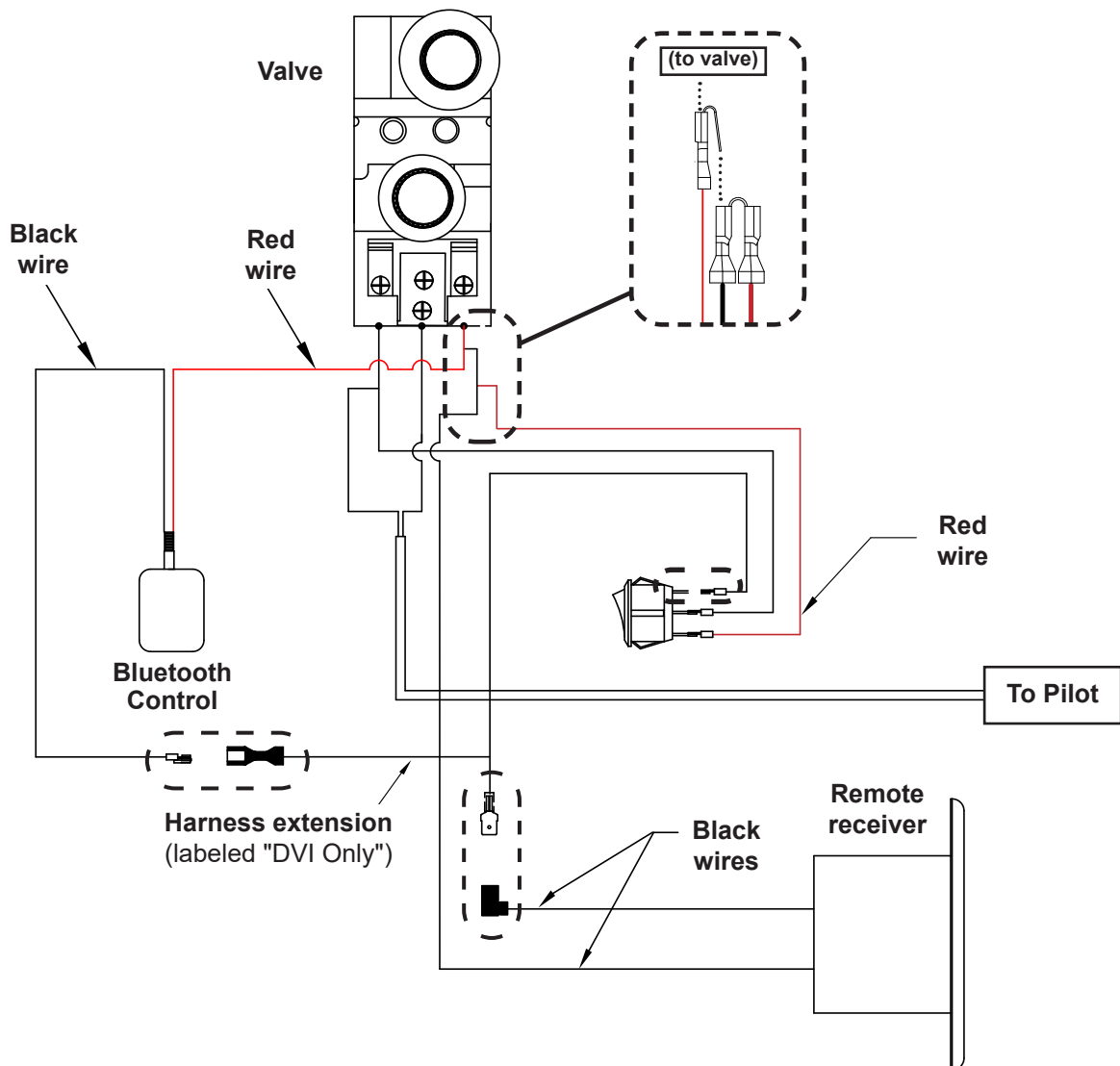

INSTALLATION AND BURNER CONFIGURATION (Cont.)

Note: This model requires a new harness extension (included) to complete installation. See the [PARTS LIST](#), and use the correct extension labeled "DVI ONLY".

Disconnect wire assembly from valve

(Left side of insert, behind surround door)

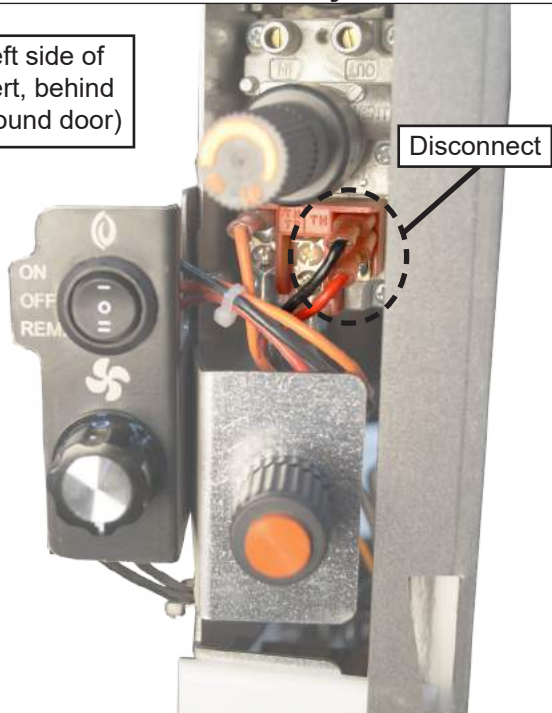

Plug wire harness into bluetooth control, connect wire assembly onto tab of red wire

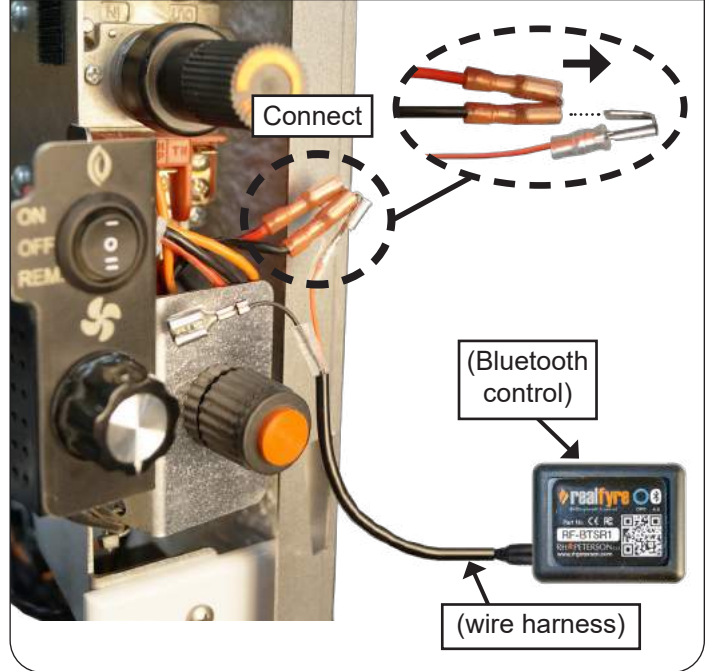

Connect bluetooth control red wire to exposed terminal on valve

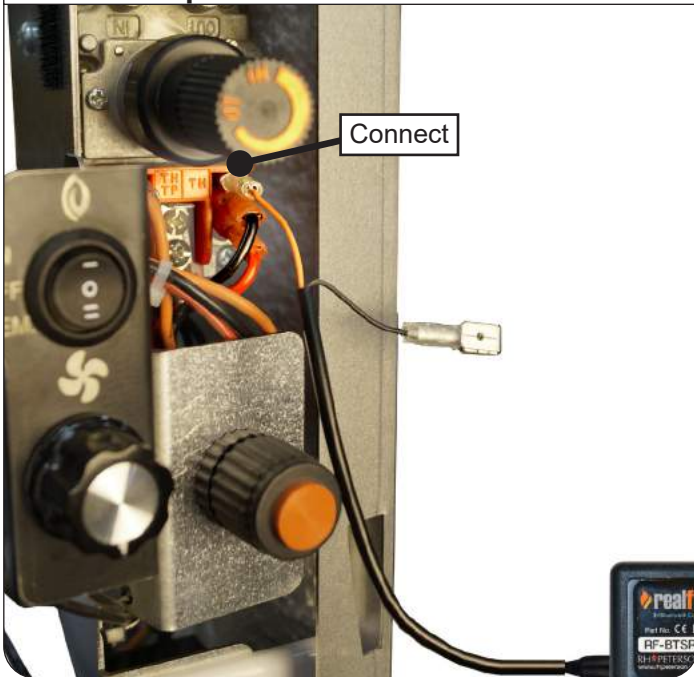

Disconnect top connector on 3-position switch

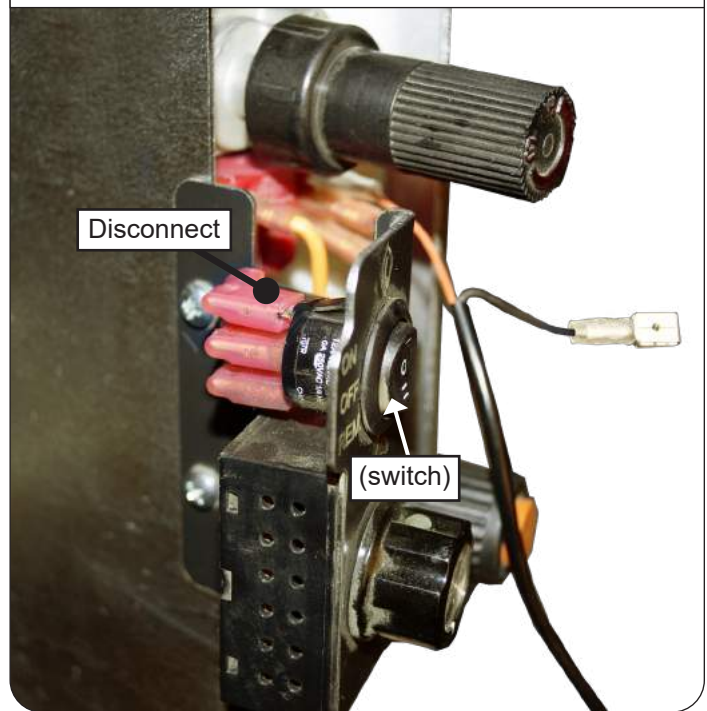

INSTALLATION AND BURNER CONFIGURATION (Cont.)

Connect new harness extension (included) to wire removed in previous step

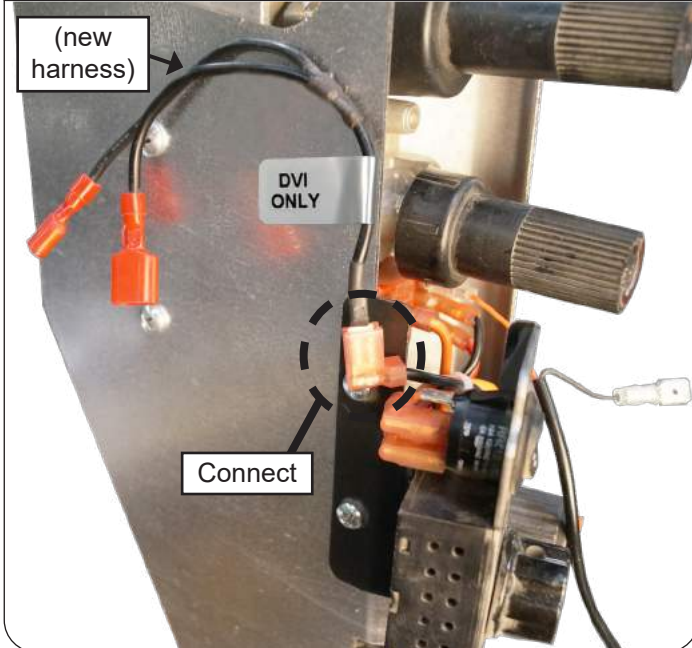

Connect bluetooth control black wire onto 1/4" male connector of harness

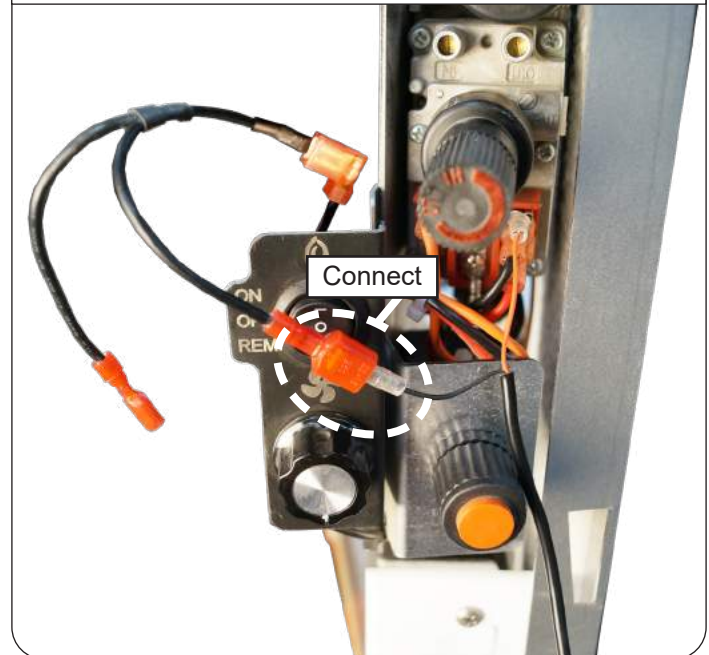

Connect 3/16" female connector of harness to terminal on rear of switch

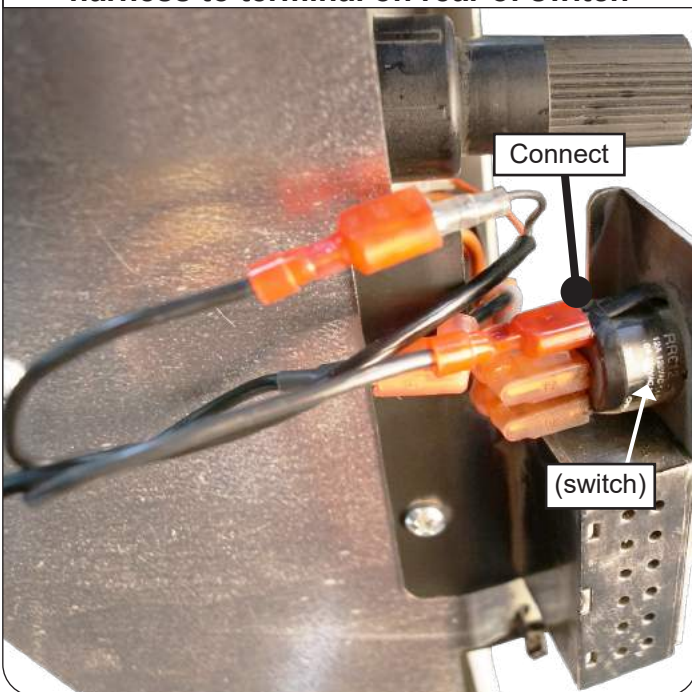

Use Velcro to secure bluetooth control, then zip tie wires as shown

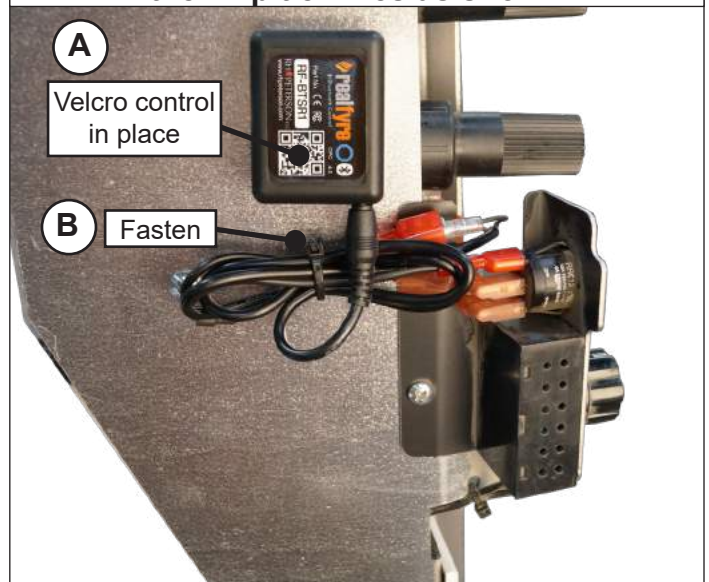

- Reminder: ensure the battery is installed at this stage. Refer to the [INSTALL/REPLACE BATTERY](#) section.
- The wood chunk is not for use with the Direct Vent system.

Continue to next page for details on setting burner system to proper positions.
(To allow for use of remote app.)

CONFIGURE DIRECT VENT FOR APP USE:

Refer to REMOTE LIGHTING of the LIGHTING INSTRUCTIONS in the direct vent owner's manual, ensuring that:

- the gas supply is turned back on
- the pilot is lit
- the PILOT/ON/OFF control knob is in the ON position
- the remote receiver is in the REMOTE position
- the 3-position mode switch is in the REMOTE position

Installation is complete. Go to the [APP SETUP](#) section.

For videos on app setup and operation, visit www.realfyre.com/bluetooth-control/ and locate the App Setup and App Operation videos.

CREATE AN ACCOUNT

Note: This app setup process must be repeated for each device in the household that will be used for operation. Download the "RHP Connect" app from the Peterson website or by searching in your app store (see Fig. 33-1 for app logo). Then follow the prompts on your screen to create an account. See Fig. 33-2 through Fig. 33-4 for details.

- You will receive an e-mail with a confirmation code; please check junk/spam folders in case the e-mail gets blocked.
- For select devices, you can sign in using external platforms such as Google or Facebook.



Fig. 33-1
Download RHP Connect

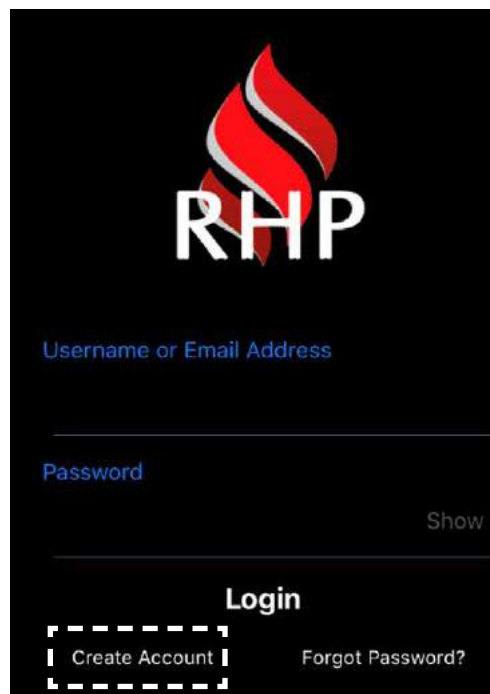

Fig. 33-2 Select create account / sign up

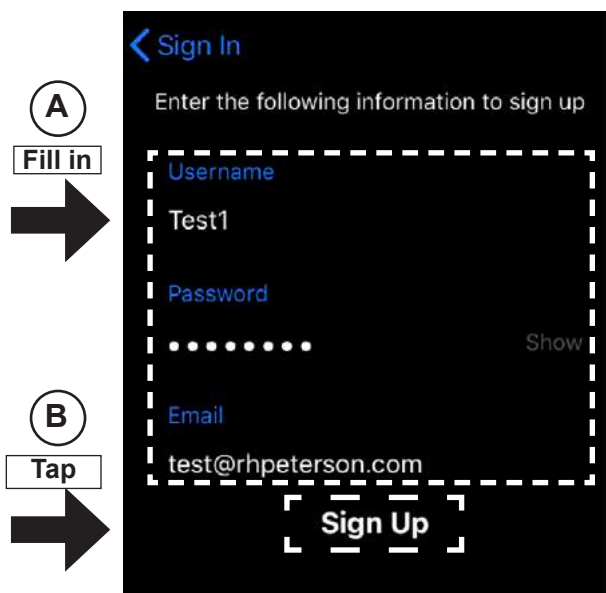

Fig. 33-3 Fill out screen and sign up

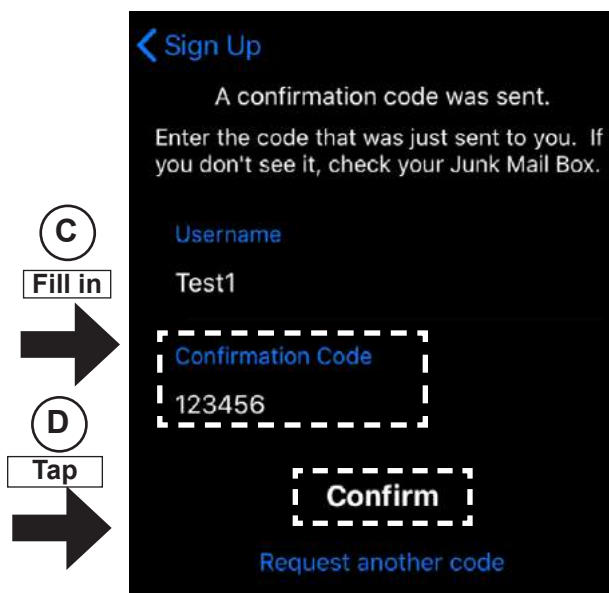

Fig. 33-4 Confirm sign up

APP SETUP (Cont.)

CREATE AN INITIAL ZONE

Once your account is created, proceed to the "Zones" screen, and if needed tap the ⊕ icon to enter the "New Zone" screen as shown below. Fill in the "Enter Location" field. The other fields should auto-fill. Then tap "Save Zone". See Fig. 34-1 and Fig. 34-2 for details.

Note: It is recommended you allow RHP Connect to access your location for full functionality of the app.

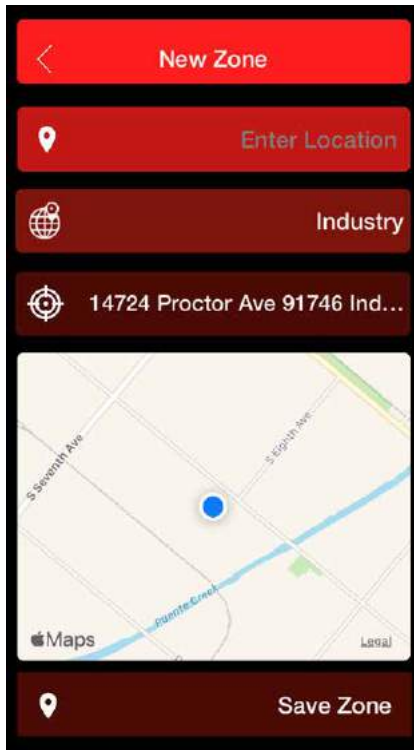

Fig. 34-1 Create zone

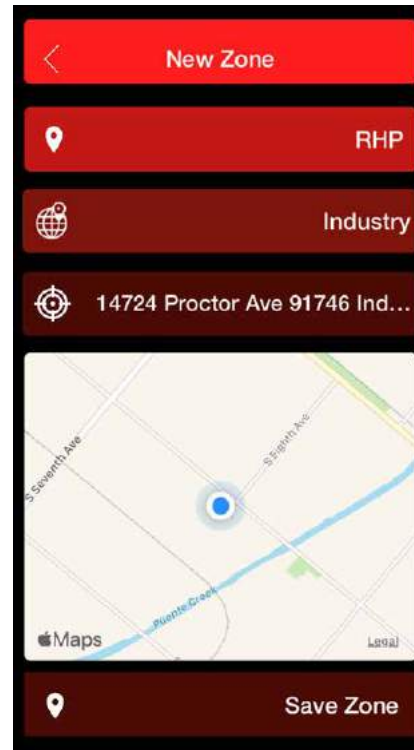

Fig. 34-2 Save zone

ADD YOUR DEVICE

Proceed past the "Zones" screen into the newly created zone. Follow the prompts to pair your device's bluetooth with the control unit. Once paired, the screen should appear as below (or similar). Fill in the fields as needed. Then tap "Connect". See Fig. 34-3 and Fig. 34-4 for details.

Note: You may need to gently tap your device on the control unit to pair.



Fig. 34-3 Add your device

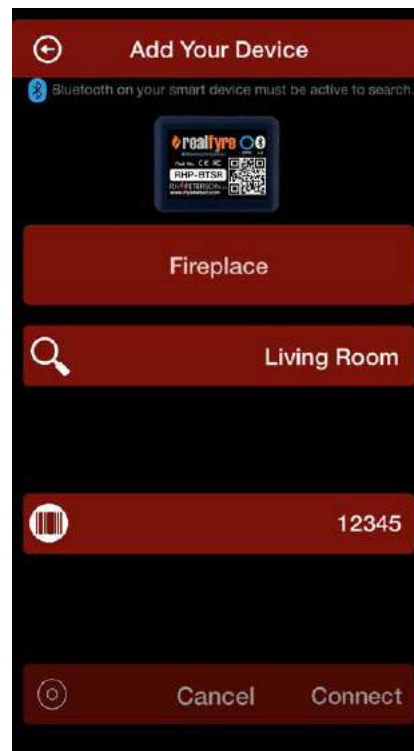

Fig. 34-4 Confirm connection

SETUP COMPLETE

Once you have successfully entered your unit, it will appear as shown below in the "Device" screen. Your remote is now ready. Proceed to the [OPERATION](#) section for details on use.



Fig. 35-1 Setup complete

FORGOT PASSWORD

Select "Forgot password" on the home screen. Then follow the prompts on your screen to update your password. See Fig. 35-2 through Fig. 35-4 for details.

- You will receive an e-mail with a confirmation code; please check junk/spam folders in case the e-mail gets blocked.



Fig. 35-2 Select forgot password

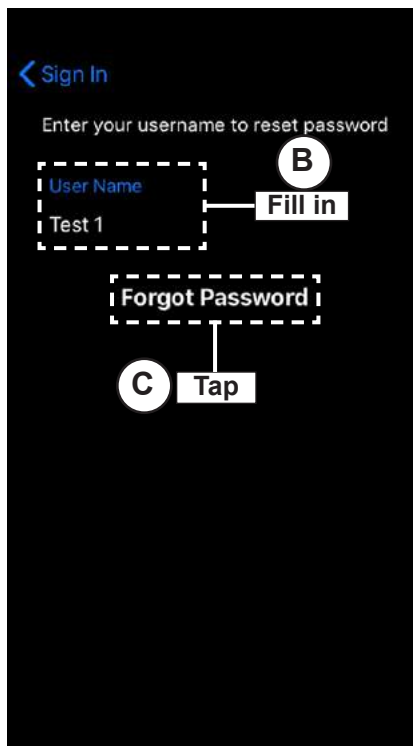

Fig. 35-3 Fill out screen

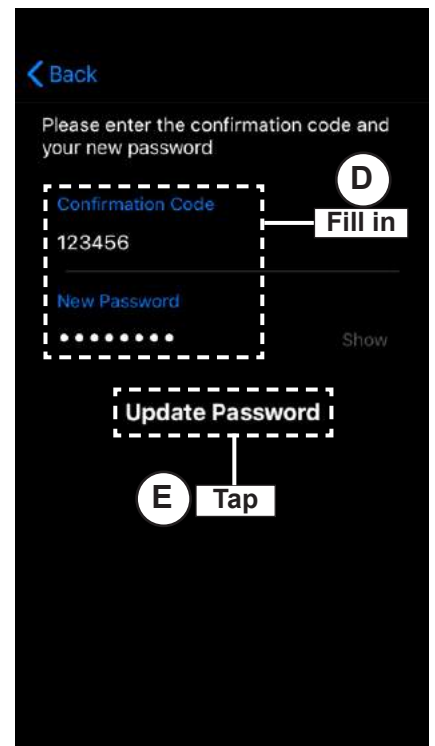

Fig. 35-4 Update password

OPERATION

BEFORE USE

Ensure that the burner system and bluetooth control are installed, and that the burner system is in the proper positions to allow for use of the remote app. (See [INSTALLATION AND BURNER CONFIGURATION](#) section if needed.)

Note: This is a bluetooth device. It has a max range of operation of 30 feet, and can only be controlled by one phone/tablet at a time.

TURNING ON THE BURNER

1. Proceed to the Devices screen and select your unit. The remote screen will appear. See Fig. 36-1 and Fig. 36-2.
2. Tap the ON icon found on the bottom left of your remote screen (see Fig. 36-2).
3. The burner will ignite and the screen will begin to display a center flame and moving sparks. The center flame and sparks flame indicate the bluetooth control is on. See Fig. 36-3.

WARNING: The burner ON/OFF status must be verified in person - it is an attended appliance.

WARNING: If the burner does not light, tap the OFF icon. Allow five (5) minutes for any gas in the unit to dissipate, then repeat process. IF YOU SMELL GAS, SEE STEP (B) AT BEGINNING OF LIGHTING INSTRUCTIONS IN YOUR BURNER INSTRUCTION MANUAL.

If the unit fails to light, see BEFORE USE above.

TURNING OFF THE BURNER

1. From the remote screen, tap the OFF icon found on the bottom left of your screen. The burner will turn off and the screen will no longer display moving sparks. See Fig. 36-2.
 - If you turn the burner on using the remote app, turn off using the remote app.
 - If you are unable to turn off the burner using the remote app, turn off by switching the manual switch on the burner system to the OFF position.
 - If you turn the burner on using the burner or remote transmitter, turn off using the burner/remote transmitter.
 - App does not turn off (or on) standing pilots (if applicable).

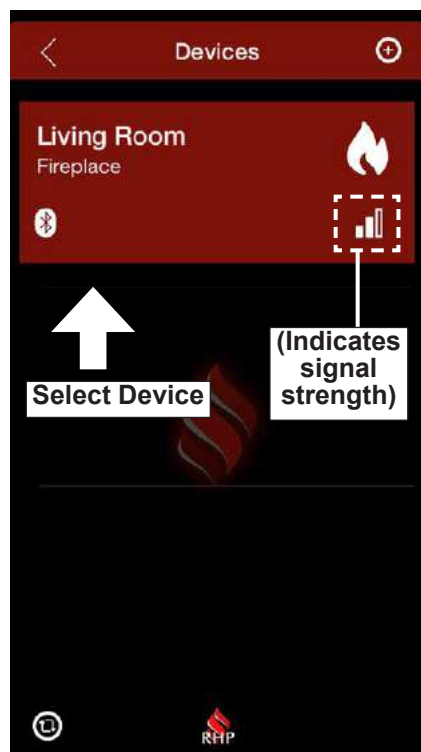

Fig. 36-1 Select Device

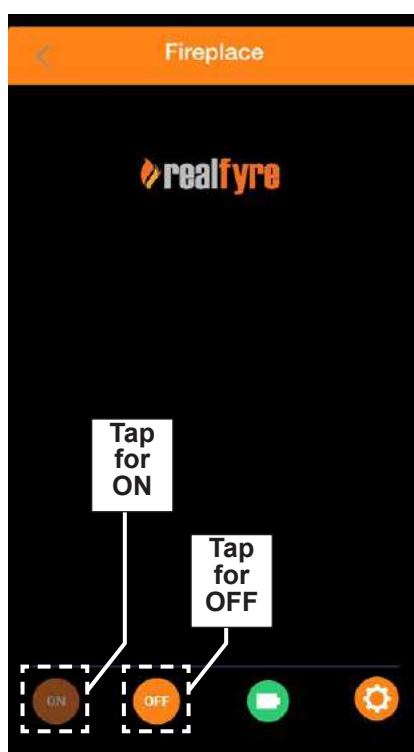

Fig. 36-2 Tap ON/OFF icon



Fig. 36-3 Screen during ON setting

CHECKING THE BATTERY

The remote screen displays a battery icon on the bottom right of the screen. Tap the icon to enter and view the battery level. Tap the confirm icon to exit the screen. See Fig. 37-1 and Fig. 37-2.

SETTINGS

The remote screen displays a settings icon on the bottom right of the screen. Tap the icon to enter and view the settings. Adjust as needed. Tap the confirm icon to exit the screen. See Fig. 37-1 and Fig. 37-2.

Note: Turning the Notifications to "On" will enable a 2 hour reminder on your phone. This features informs you that the burner has been on for 2 hours, via a pop up notification. To disable, simply turn off the Notifications option. See Fig. 37-2.

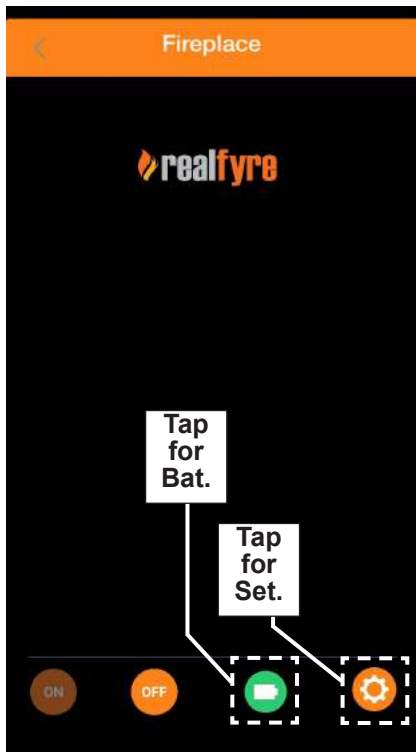

Fig. 37-1 Remote screen detail



Fig. 37-2 Battery screen

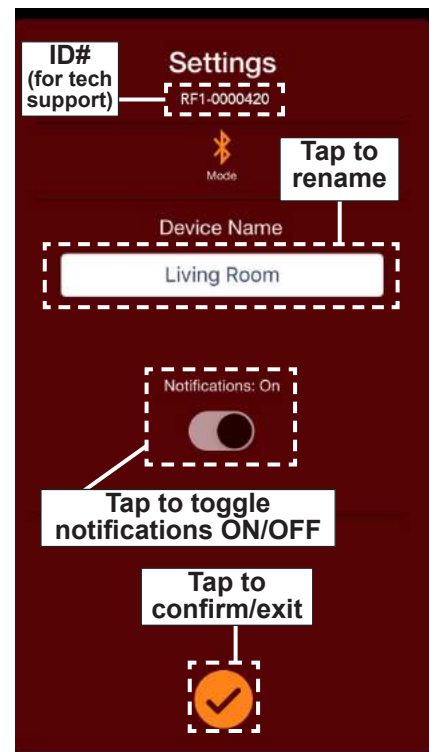

Fig. 37-3 Settings screen

ADDING, EDITING, DELETING A NEW ZONE OR DEVICE

- To add an additional zone or device, tap the ⊕ icon found on the top right of your screen (see Fig. 38-1 or Fig. 38-2).
- To delete a zone or device, slide your finger across the desired unit, and tap "Delete" (see Fig. 38-1 or Fig. 38-2).
- To edit an existing zone, slide your finger across the desired zone, and tap "Edit" (see Fig. 38-1).

LOGGING OUT

To log out, simply click on the logout icon and then tap yes (see Fig. 38-3).

Note: To prevent unwanted use, it is recommended to log out after device is turned off.

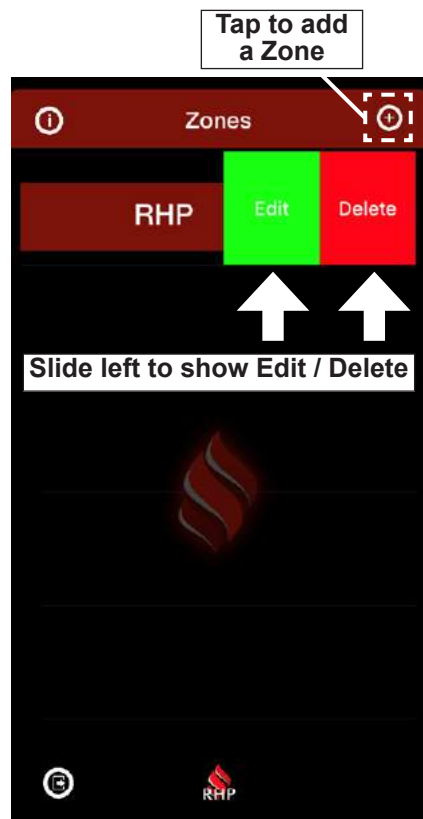

Fig. 38-1 Add/Edit/Delete Zone

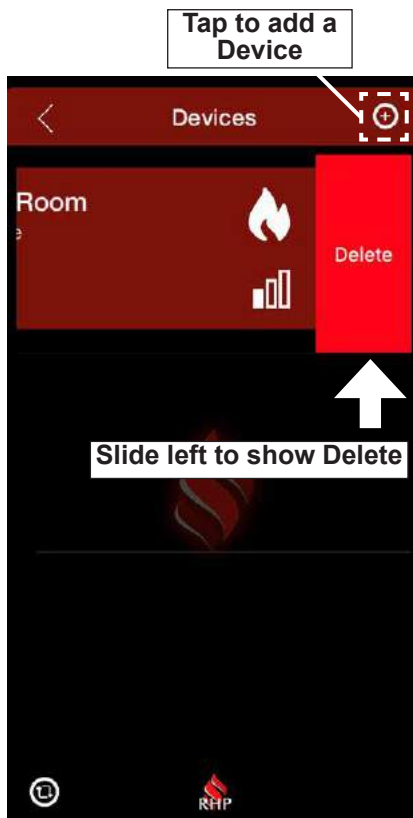

Fig. 38-2 Add/Delete Device

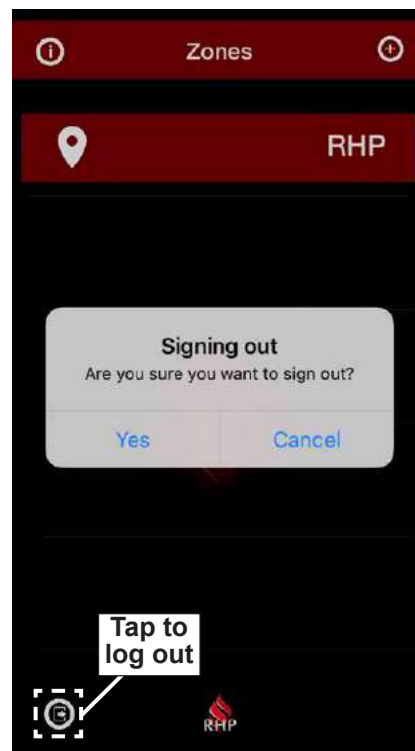

Fig. 38-3 Logging out

TROUBLESHOOTING

INSTALLATION OR APP USE ISSUES

If you have trouble with the [bluetooth control installation or app use](#), please reference this list below to identify the problem.

SYMPTOM	PROBABLE CAUSE	CORRECTIVE ACTION
Burner system will not turn on	<ol style="list-style-type: none"> 1. Incorrect wiring setup 2. Phone out of range of bluetooth control 3. Dead battery 4. Battery installed backward 5. Electronic device not paired with bluetooth control 6. Faulty bluetooth control 	<ol style="list-style-type: none"> 1. Refer to INSTALLATION AND BURNER CONFIGURATION section to ensure proper installation. 2. Ensure phone is within 30 feet or less of the control. 3. Refer to INSTALL/REPLACE BATTERY section for details. 4. Reverse battery in bluetooth control. Refer to INSTALL/REPLACE BATTERY section for details. 5. Pair device (refer to ADD YOUR DEVICE section for details). 6. Check/replace bluetooth control.
Bluetooth control does not respond to electronic device	<ol style="list-style-type: none"> 1. Electronic device not paired with bluetooth control 2. App update needed 3. Loose wires 	<ol style="list-style-type: none"> 1. Pair device. 2. Check for App updates. 3. Check all wires are connected properly.
Burner system will not turn off	<ol style="list-style-type: none"> 1. Phone out of range of bluetooth control 2. Dead battery 3. Burner was not turned on with the Remote App 4. Unable to locate or use the Phone App 5. Faulty bluetooth control 	<ol style="list-style-type: none"> 1. Ensure phone is within 30 feet or less of the control. 2. Refer to INSTALL/REPLACE BATTERY section for details. 3. If you turned the burner on using the burner or remote transmitter, turn off using the burner/remote transmitter. 4. If you are unable to turn off the burner using the remote app, turn off by switching the manual switch on the burner system to the OFF position. 5. Check/replace bluetooth control.

TECHNICAL APP ISSUES

If you need assistance on a [technical issue related to the app \(log in, connectivity, etc.\)](#), please e-mail the app support department support@app-assist.com.

BURNER SYSTEM ISSUES

If you have trouble with the [installation or operation of the burner system](#), see the TROUBLESHOOTING section of the manual included with your burner.

If the information on this page does not resolve your issue, please contact your local dealer, e-mail our general support department: support@rhpeter.com, or visit our web site at www.rhpeter.com.

Please use this page to record any information that you may want to have at hand.