

Primary Usage
Reference No.
Sign. and date
Copy inv. No.
Repl. Inv. No.
Sign. and date
Orig. Inv. No.

4" Plastic Channel

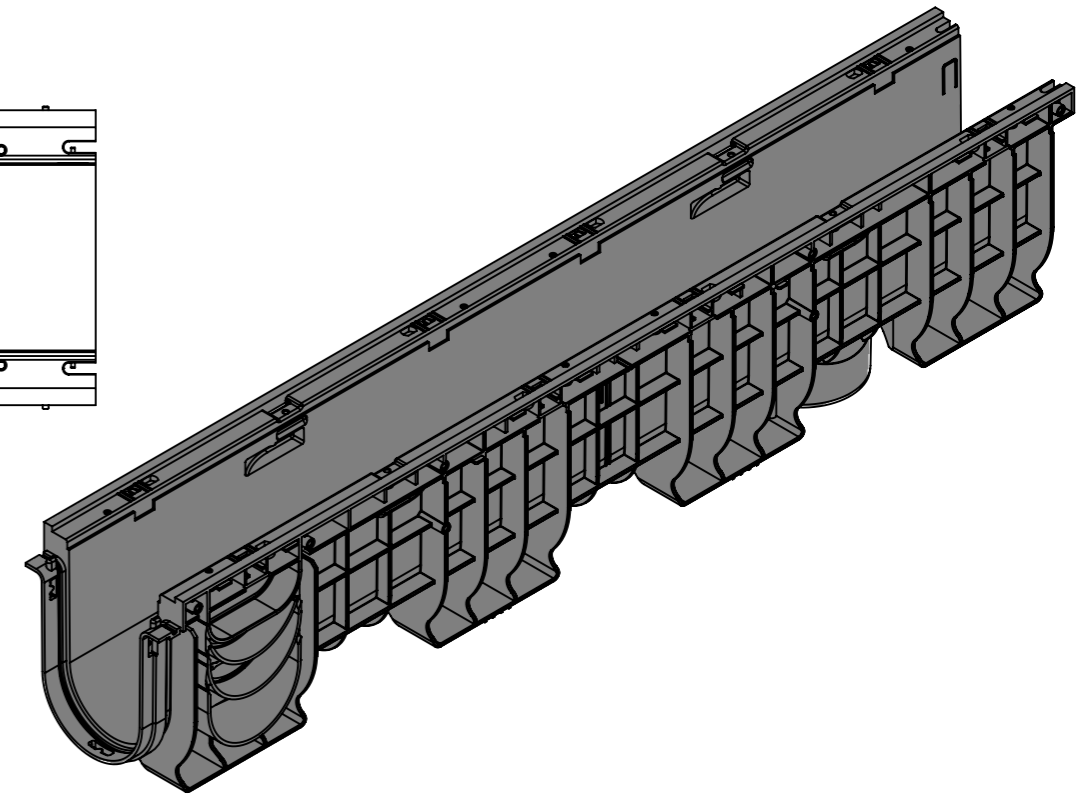
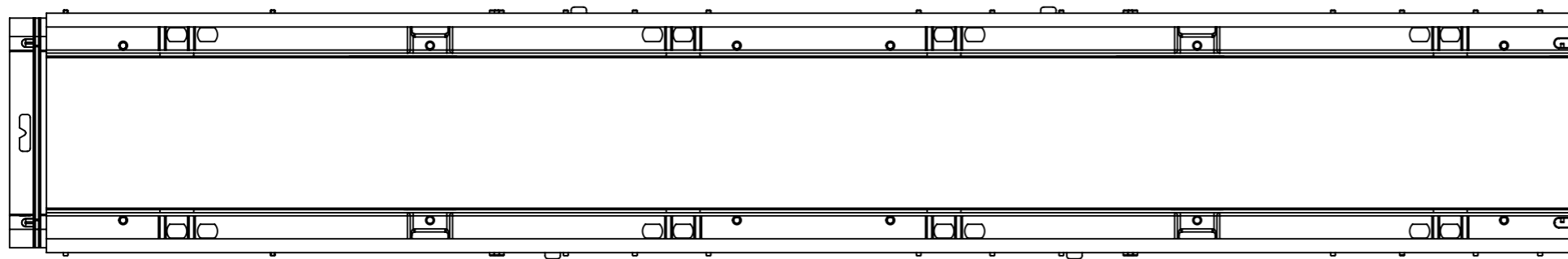
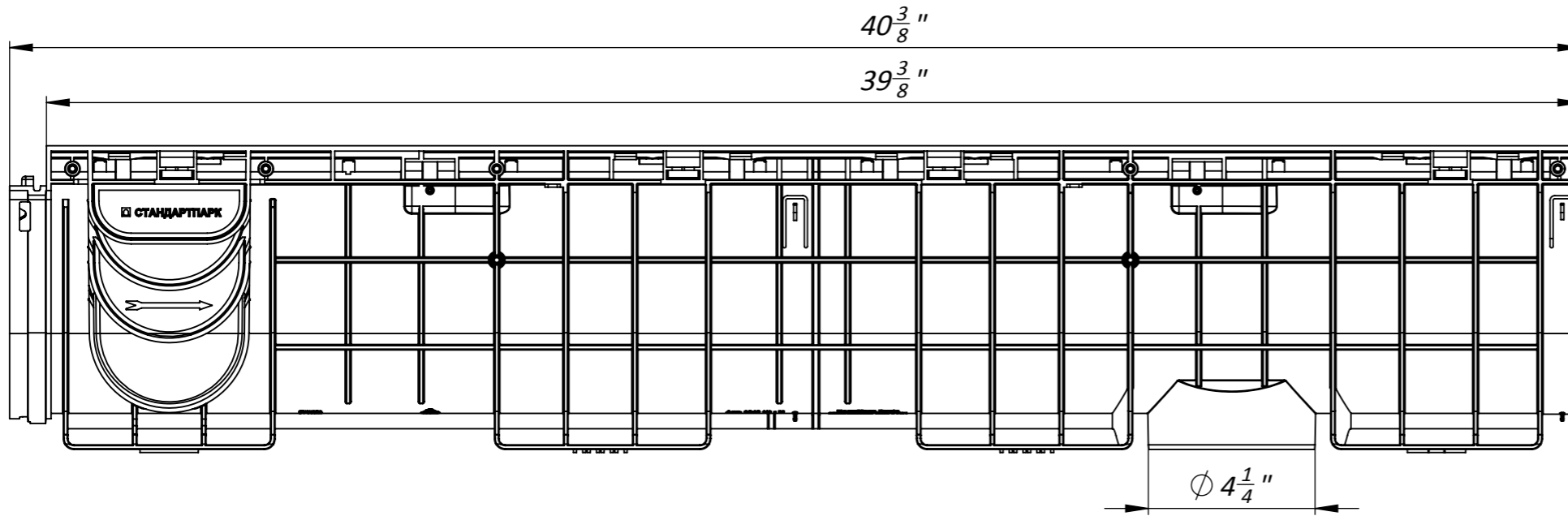

Deviation of the actual weight of the nominal can be up to 10%

					Art. 8040-M			
					4" Plastic Channel			
Rev.	Sheet	Doc. No.	Sign.	Data	8040-M	Let.	Weight (lb)	Scale
				11.09.18			5.62	1:4
					Load Class C	Sheet		Sheets 1
					Plastic			