

Primary Usage
Reference No.
Sign. and date
Copy inv. No.
Repl. Inv. No.
Sign. and date
Orig. Inv. No.

4" Plastic Channel

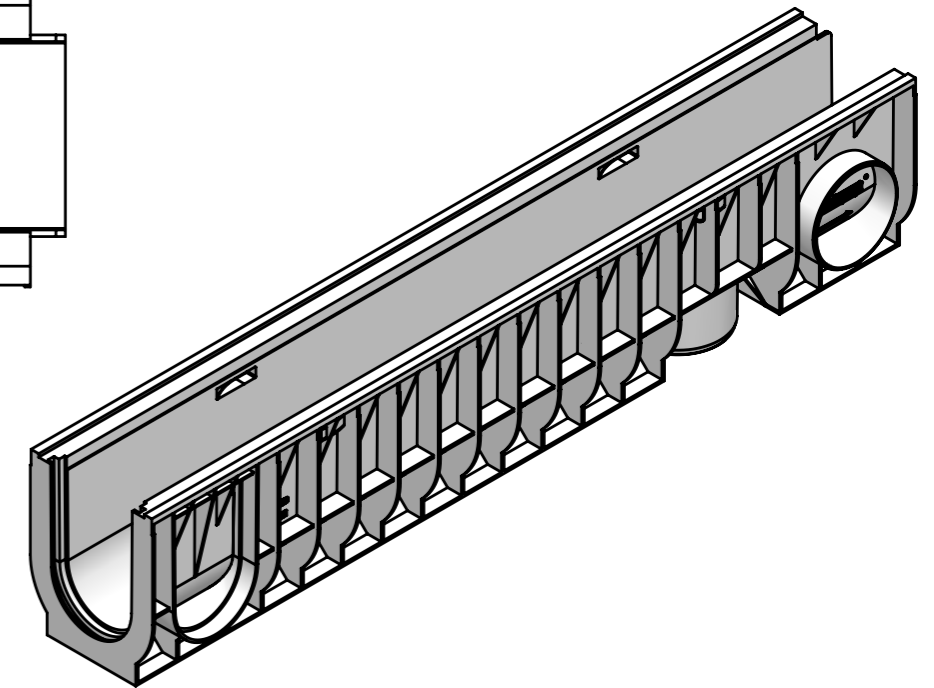
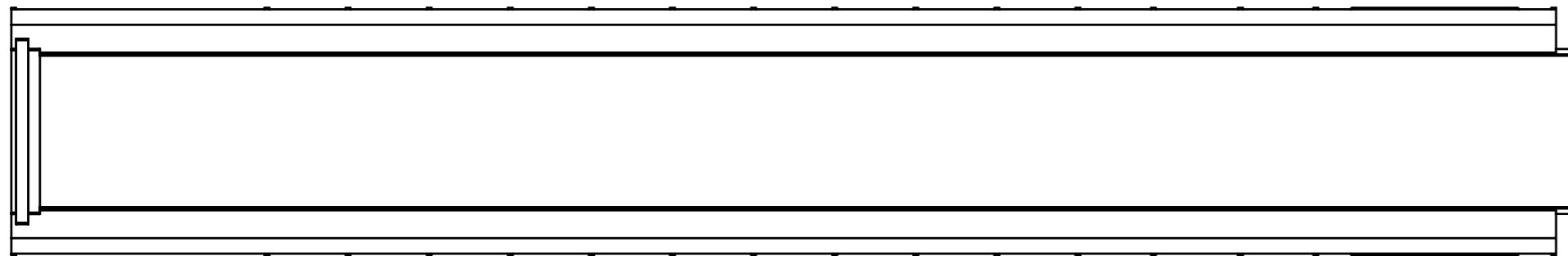
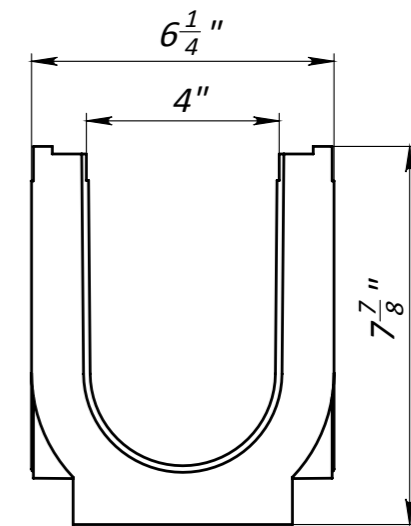
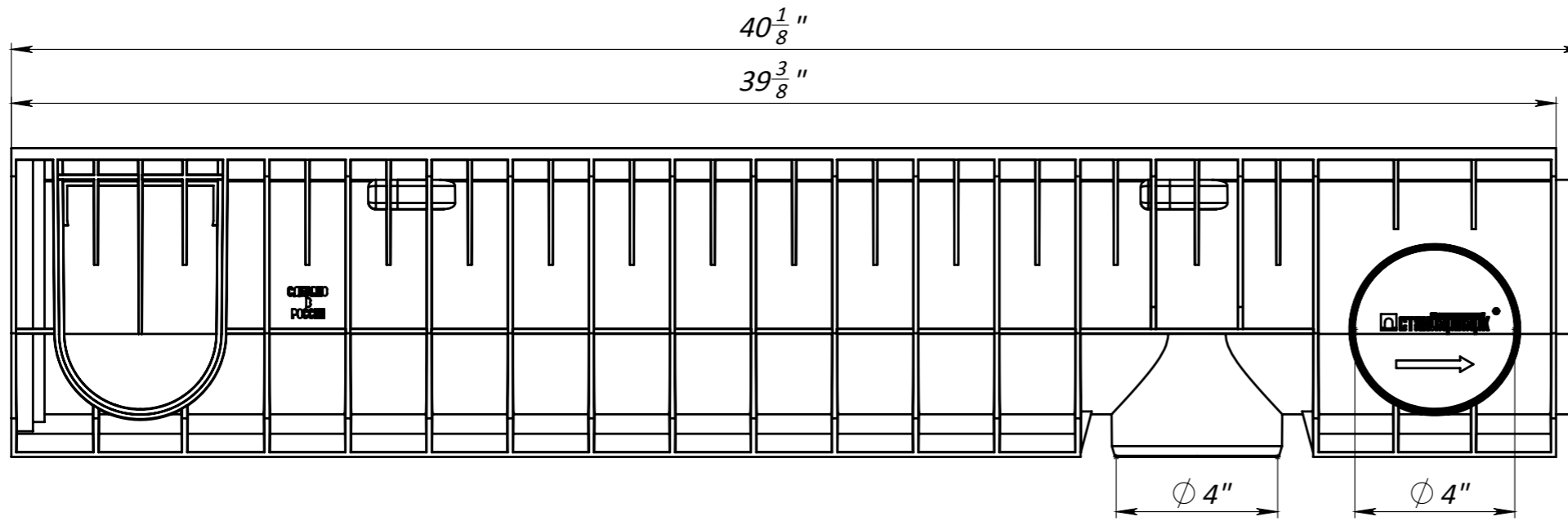

Deviation of the actual weight of the nominal can be up to 10%

					Art. 8040			
					4" Plastic Channel			
Rev.	Sheet	Doc. No.	Sign.	Data	8040	Let.	Weight (lb)	Scale
				11.09.18			5.98	1:4
					Load Class C	Sheet	Sheets 1	
					Plastic	