

CINCINNATI
MICROWAVE®

CINCINNATI
MICROWAVE®

CINCINNATI MICROWAVE
5440 West Chester Road
West Chester OH 45069
Sales/Service 800-433-3487
EscortRadar.com

©2014 CINCINNATI MICROWAVE.
ESCORT, Laser ShifterPro, Speed Of Light Protection and CINCINNATI MICROWAVE are trademarks of Escort Inc.



Laser ShifterPro™

S P E E D O F L I G H T P R O T E C T I O N ™

LASER SHIFTING TECHNOLOGY • INSTALLATION REQUIRED

THE ULTIMATE
LASER DEFENSE SYSTEM

Installation and Owner's Manual

Congratulations

Your new Laser ShifterPro is the most advanced defense system against targeting laser guns. Laser ShifterPro comes complete with a comprehensive owner's and installation manual, twin front-mounted Laser Shifters, panel mounted On/Off Switch, 12-volt Interface with integrated speaker and volume control, modular connections, complete wiring harnesses, and mounting hardware.

Please read the manual in detail to get the most out of your new Laser ShifterPro's performance and features.

Please drive safely.

Please Note

This product may be limited or prohibited in some jurisdictions. Check applicable laws before using.



Important Installation Warning

The Laser ShifterPro requires professional installation. New car dealers, and a select group of car audio specialists can install the Laser ShifterPro for you. Call us toll-free at 1-800-433-3487, or visit our website at LaserShifting.com for an authorized dealer near you.

Attempting to install the Laser ShifterPro without expertise in automotive electronic installations can cause personal injury during the installation, or can damage your Laser ShifterPro or your vehicle. If your vehicle is damaged during installation, its safety systems may be compromised, which could cause personal injury or property damage.

Laser ShifterPro was designed to meet high performance and quality standards; however, there are certain precautions that must be considered before approaching installation and operation:

- Use only original Laser ShifterPro parts included with your unit. Do not plug any third-party components into your unit, and do not plug any supplied components into any third-party products, as this may cause failure and will void warranty.
- Special care must be taken during installation of outer sensors, as damaging factory-installed cables or connectors may cause damage or device malfunction and may void warranty.
- While outer sensors are specially designed and manufactured to be installed outside and to operate in harsh environments, the control unit must be installed and kept in a dry place, preferably somewhere inside the driver's cabin. Failures due to improper installation may void warranty.

- Laser ShifterPro cannot detect glass or other transparent objects, and certain materials may absorb infrared light.
- Check your local laws before using Laser ShifterPro, as transmitted light can interfere with other laser equipment.

Maintenance

Once Laser ShifterPro is installed, dirt and filth can accumulate on the front covers of the sensors, especially during the winter. To ensure peak performance, check front covers of sensors often and, if necessary, wipe clean with a cloth.

Warning

Never, under any circumstances, look at the sensors while powered on and operating. Do not view with optical instruments (like magnifiers).

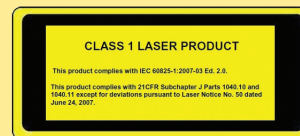

What's Included

ShifterPro Interface



Wiring Harness



Two (2) ShifterPro Sensors



Hardware Accessories



Vehicle Sensor Installation

Important!

Plan your installation carefully. It is highly advisable to inspect the entry points from the engine compartment into the driver's cabin before installation of sensors. For optional rear sensor installation, look for entry points behind the license plate or lights.

If you are unable to find entry points, you will need to drill a hole at least 0.2 in (5 mm) in diameter to route the cable into the cabin. (If installation is performed by a professional, consult with your customer before drilling any holes.) Apply rubbing alcohol if needed, so you can easily pull cable into the cabin without damaging it.

After installation is complete, use cable ties to fasten sensor cables to a solid surface, keeping them away from heat and any moving parts.

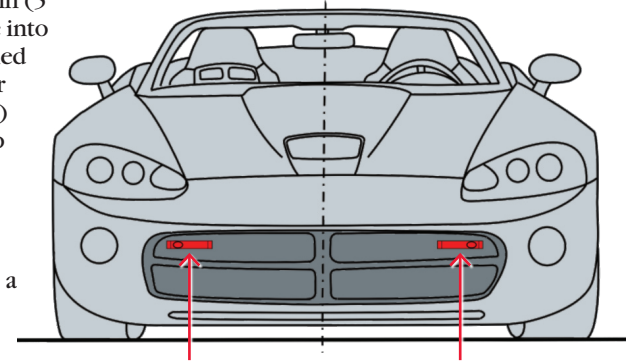

Vehicle Sensor Installation Continued

Positioning Sensors

Install each sensor halfway between the side and the center of the vehicle.

For optimal performance, sensors need to be facing straight forward (or backward, if installing optional rear sensors), not at an angle. Make sure that each sensor is parallel with the road (using supplied bubble level).

Note

Vehicle must be positioned on a flat surface in order to position sensors parallel with the road. Make sure that sensors have an unobstructed “view” of the road so the unit can function properly. Do not install sensors behind a solid surface, which would block laser transmission/reception.

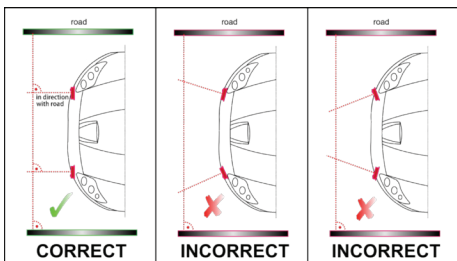
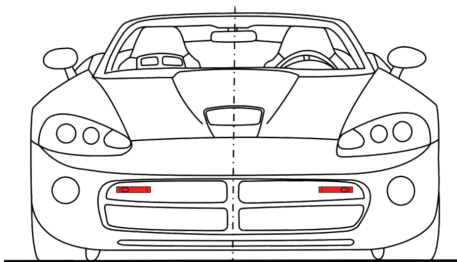
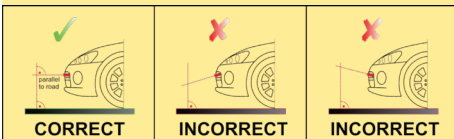

Individual Sensor Installation

- 1 Using bolts, nuts and washers, mount sensor to supplied L-shaped bracket and tighten firmly.
- 2 Using screws, mount L-shaped bracket (with sensor attached) to solid surface of vehicle grill.
- 3 Use supplied bubble level to check alignment of the sensor and ensure it is parallel to the road.
- 4 Repeat for additional sensor(s).

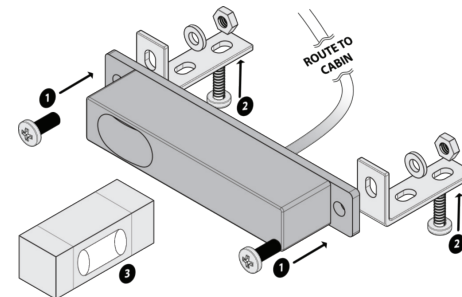

If you must install sensors behind the front grill of the vehicle, it is crucial that they be positioned in such a way that the receiver and transmitter components have unobstructed “views” of the road. The image at right shows the positions of both the receiver and transmitter components within the sensor. The 19.5 mm (0.77 in) ellipse (0.77 in) represents the receiver lens, while the 5 mm (0.20 in) circle represents the laser diode transmitter.

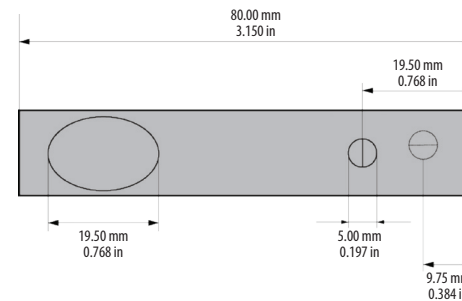

Securing Connectors with Shrink Tube

Once you’ve installed all components properly and tested to ensure all parts are working properly, it is advisable to use the supplied heat-shrink tubes to protect connectors against water, moisture, dust, etc.

Important!

Plan your installation carefully. First, find a convenient place to position the ON/OFF switch—preferably within the driver’s reach. Make sure that after routing the wiring harness from the +12V switched circuit to the control unit’s power plug you have enough cable to connect the wiring harness to the switch.

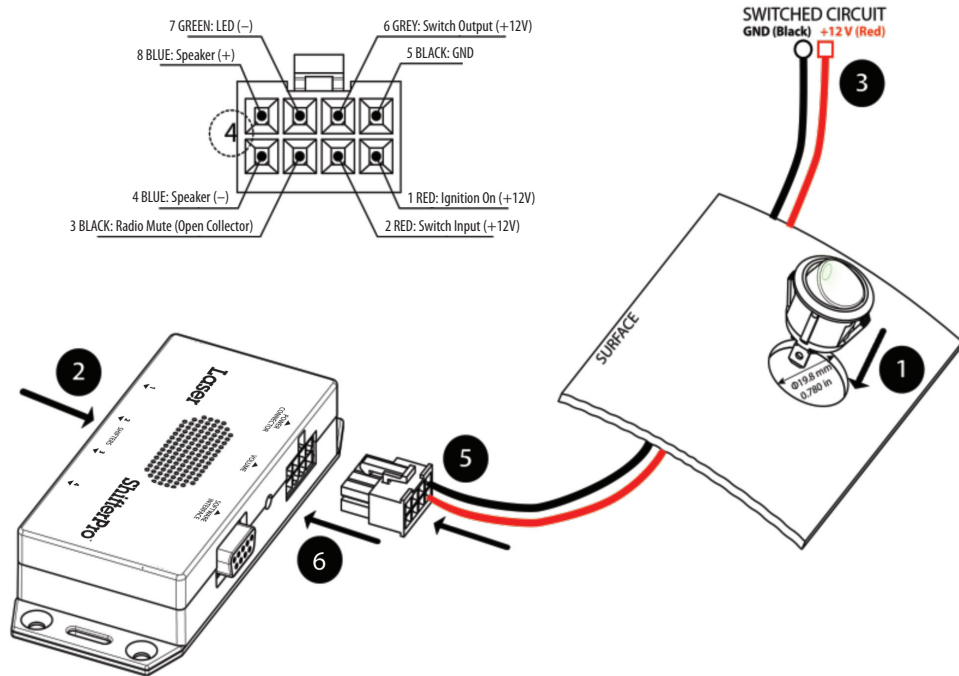

- 1 Locate an appropriate place for drilling a hole for the power switch. It is recommended that you place it within the driver’s reach. If you’d like to receive visual warnings (i.e., LED blinks during an alert), ensure you choose a location where it will be visible to the driver. Drill a hole at least 19.8 mm (0.78 in) in diameter, so the switch can fit snugly through the hole.
- 2 Position the control unit inside the cabin, somewhere under the dashboard, in such a way that you can easily connect the sensor cables you previously routed. Connect front sensor cables into ports 1 and 2. (If applicable, connect rear sensor cables into ports 3 and 4.)
- 3 Connect the black wire from the wiring harness to the negative ground power supply or to the vehicle chassis. Locate access to power supply and connect the red wire from the wiring harness to the +12V switched circuit power supply (typically, the car radio power supply).

- 4 Optional: To automatically mute the radio audio during an alert, connect the blue audio wires to the audio mute input of your car radio.
- 5 Plug in power connector until it “locks,” and power on your device.
- 6 To adjust volume, insert a thin flathead screwdriver into the volume adjustment hole on the control unit and turn.

Downloading and Updating Software

To customize your device preferences and keep your unit up to date you will need to download the Laser ShifterPro Tools Software. Software can be downloaded from our website free of charge for all Laser ShifterPro users. You must first register your device at escortinc.com. Once registered, you will receive e-mail notifications when updates are available.

Visit our website at www.EscortInc.com for further details.

Using the Device

Once installation is complete and you have set your preferences using the Laser ShifterPro Tools Software, operation of Laser ShifterPro is automatic, so you can enjoy your experience on the road.

If you have connected the power supply to the switched circuit, once you start the ignition, the control unit will check that all components are working properly, and you will receive a “welcome” sound.

Upon detecting a signal, the unit will alert you, and the sensors will automatically start running defense algorithms. Check and adjust your speed if necessary based on the posted speed limit.

Software Function

Description

Connect	Connect your unit with your PC.
Load Settings	Load parameters from unit that were uploaded previously.
Upload Settings	Upload parameters you selected onto your unit.
Voices	Upload voice pack: <ul style="list-style-type: none"> • Download latest voice pack version. • Extract voice pack folder from archive to local folder of PC. • Navigate to voice pack folder file and upload (may take 3–5 minutes).
Firmware Update	Update firmware version: <ul style="list-style-type: none"> • Download latest firmware version. • Extract firmware from archive to local folder of PC. • Navigate to firmware file with extension .LI and start upload.
Sun Interference (SI) Alert Sensitivity	• Adjust your sensors' sensitivity to the sun. If SI alert sensitivity is too high, it is possible that you will receive SI alerts even when the sun is very weak.
Sun Interference (SI) Recycle Time	• Adjust repetition frequency of SI alerts.
Sensor Sensitivity	• Adjust sensor sensitivity to light sources. If you are receiving a lot of false alerts, you can decrease the sensitivity. It is rare that you will need to increase sensitivity. High sensitivity may cause malfunction. The default (optimal) sensitivity is -2.
Unknown Gun Alert	Enable or disable ability to detect new and unknown laser signals.
Laser Detector	Enable or disable use of Control Switch—Detector-Only Switch (sold separately).
Jam Duration (seconds)	Define length of jamming sequence. Device will go to “self standby” mode after finishing sequence.
Jam Restart Time (seconds)	Define length of self standby. Device will return to jamming mode after expiration of defined standby.
Check Sensors	Define on which ports you have sensors connected. Based on which ports you select, each time you power on the unit, it will run a functional self-test on selected sensors. You will receive an alert if one or more sensors are malfunctioning.

In certain situations it's possible that you will receive error messages because of low car battery voltage, or a voltage drop after starting the ignition on diesel vehicles. In those cases, consider changing your car's battery.

Error Description

Defining Malfunctioned Component

Receiving error message after control unit self-test

- 1** Make sure that the number of sensors in software matches number of sensors you purchased and plugged into your unit.
- 2** Check that sensors are plugged into the same ports that you selected in software for self-test (standard is port 1 and port 2).
- 3** Remove sensor from port where you are not receiving an error message (e.g., port 1) and plug it into the port for which you're receiving the error message (e.g., port 2); that is, swap the sensor cables from one port to another.
 - A** If still receiving an error message for the initial port with error (e.g., port 2), it is possible there is a unit malfunction:
 - 1** Try cleaning pins of port on control unit with alcohol-based fluid.
 - 2** Contact your retailer regarding warranty.
 - 3** Disable broken port and enable new working port for self-test.
 - B** If now receiving an error message for the other port (e.g., port 1), it is possible there is a cable or sensor malfunction:
 - 1** Try cleaning modular connector and pins of cable connector.
 - 2** Swap the cables that connect the sensors to the unit from one port to another again. After doing this, if you still receive the initial error message again (e.g., port 2), that cable is probably malfunctioning. Contact your retailer regarding warranty.
 - 3** If the error persists on the second port you tried (e.g., port 1), the sensor is probably malfunctioning. Contact your retailer regarding warranty.

Receiving false alarms with low sensor sensitivity

Check how cables are routed through engine compartment. Try re-routing cables, because the source of false alarms may be EMI of some part of the engine. Unplug sensor cables one by one to determine which cable is too close to the EMI source and re-route that specific sensor cable. If problem persists, try shielding sensor with aluminum foil.

Operating Wavelength:	905 nm
Operating Temperature:	-25°C +80°C -13°F +176°F
Current Consumption:	Dual: 135 mA—560 mA Quad: 185 mA—611 mA
Sensor Dimensions:	80.3 mm (W) x 15.3 mm (H) x 22.7 mm (D) 3.16 in (W) x 0.6 in (H) x 0.89 in (D)
Control Unit Dimensions:	100 mm (W) x 25 mm (H) x 51 mm (D) 3.93 in (W) x 0.98 in (H) x 2.0 in (D)
Sensor Cable Length:	1.5 m + 4.5 m 4.92 ft + 14.76 ft
Wiring Harness Length:	1 m 3.28 ft
Extension Cable Length:	2 m 6.56 ft

ESCORT One-Year Limited Warranty

ESCORT warrants your Laser ShifterPro device against all defects in materials and workmanship for a period of one (1) year from the date of the original purchase, subject to the following terms and conditions:

- The sole responsibility of ESCORT under this warranty is limited to either repair or, at the option of ESCORT, replacement of Laser ShifterPro. There are no expressed or implied warranties, including those of fitness for a particular purpose or merchantability, which extend beyond the face hereof. Some states do not allow limitations on how long an implied warranty lasts, so the above limitations may not apply to you.
- ESCORT is not liable for any incidental or consequential damages arising from the use or misuse of Laser ShifterPro. Some states do not allow the exclusion or limitation of incidental or consequential damages, so the above limitation or exclusion may not apply to you.

This warranty gives you specific rights. You may have other legal rights, which vary from state to state. This warranty does not apply if the serial number has been removed or if your Laser ShifterPro device has been subjected to physical abuse or modification.

To obtain service, contact ESCORT at 1-800-543-1608 to obtain a Return Authorization Number.

Properly pack your product and include: your name, complete return address, written description of the problem with your product, daytime telephone number and a copy of the original purchase receipt. Label the outside of the package clearly with your Return Authorization Number.

Ship the product prepaid (insured, for your protection) to:

RMA# _____
ESCORT Inc.
5440 West Chester Road
West Chester OH 45069.

Two (2) Additional ShifterPro Sensors
w/Hardware



Extension Cable (6.6 ft)

