

BUSTER+PUNCH

LONDON

[product.]

1G TOGGLE SWITCH

[range. **ELECTRICITY.**]

[knurl. **CROSS.**]

[detail. **COIN SCREWS.**]

A tactile solid metal toggle switch with diamond-cut knurling.

The switch is finished with a solid metal flat plate and our signature coin screws. Available in four different finishes with a range of detail kits to suit any interior. They can be used in combination with our matching dimmers and outlet options.

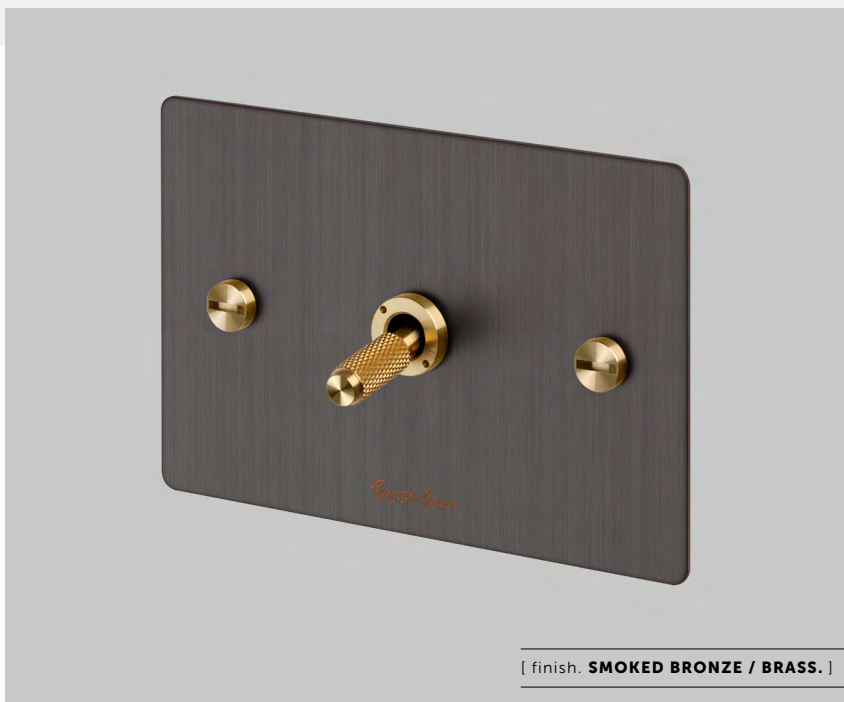

[type. **TOGGLE SWITCH.**]

[info. **MEASUREMENTS.**]

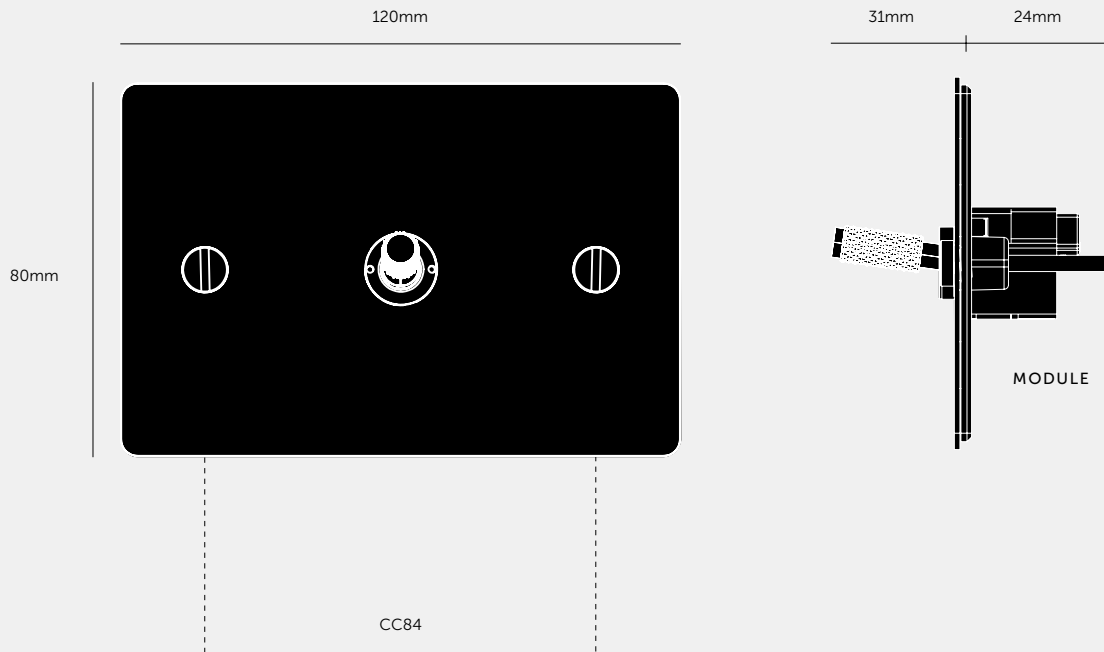

***DETAILS KITS AVAILABLE TO CREATE MIXED FINISHES**

[info. **SPECIFICATIONS.**]

Single Toggle Switch

Module Code: ZTM-01380

Style: On / Off Toggle Switch

250VAC / 10A

Single Pole / Double Throw

(can be controlled from 2 locations)

Backbox: Standard 2G.





Allow depth of module + sufficient space

for connections when choosing a backbox.

[info. **FINISH & SKU NUMBERS.**]

[finish.]





[sku.]

 Steel	ZTG-07425
 Brass	ZTG-05424
 Smoked Bronze	ZTG-09426
 Black	ZTG-02423

[info. **DETAIL KIT & SKU NUMBERS.**]

[finish.]

[sku.]

 Steel	ZTK-07632
 Brass	ZTK-05631
 Smoked Bronze	ZTK-09633
 Black	ZTK-02630

[info. **CARE INSTRUCTIONS.**]

Wipe with damp cloth with no loose hairs, avoid using any chemicals. Please note all finishes are prone to aging.

BUSTER+PUNCH

LONDON

[product.]

2G TOGGLE SWITCH

[range. **ELECTRICITY.**]

[knurl. **CROSS.**]

[detail. **COIN SCREWS.**]

A tactile solid metal toggle switch with diamond-cut knurling.

The switch is finished with a solid metal flat plate and our signature coin screws. Available in four different finishes with a range of detail kits to suit any interior. They can be used in combination with our matching dimmers and outlet options.

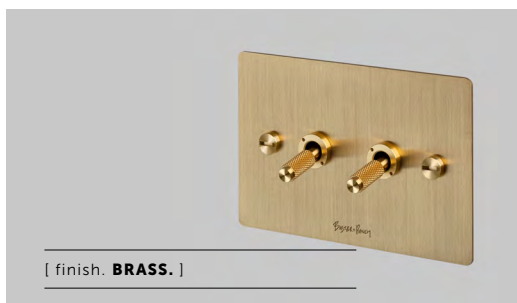

[type. **TOGGLE SWITCH.**]

[info. **MEASUREMENTS.**]

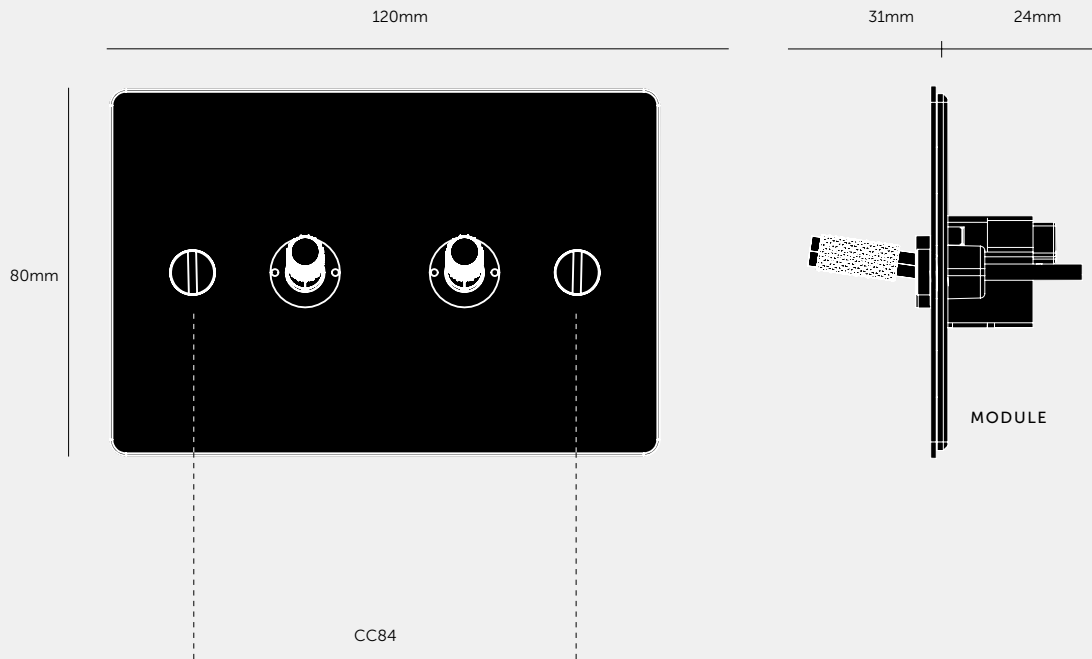

***DETAILS KITS AVAILABLE TO CREATE MIXED FINISHES**

[info. **SPECIFICATIONS.**]

Double Toggle Switch

Module Code: ZTM-01380

Style: On / Off Toggle Switch

250VAC / 10A

Single Pole / Double Throw

(can be controlled from 2 locations)

Backbox: Standard 2G.





Allow depth of module + sufficient space

for connections when choosing a backbox.

[info. **FINISH & SKU NUMBERS.**]

[finish.]





[sku.]

 Steel	ZTG-07430
 Brass	ZTG-05429
 Smoked Bronze	ZTG-09431
 Black	ZTG-02428

[info. **DETAIL KIT & SKU NUMBERS.**]

[finish.]

[sku.]

 Steel	ZTK-07632
 Brass	ZTK-05631
 Smoked Bronze	ZTK-09633
 Black	ZTK-02630

[info. **CARE INSTRUCTIONS.**]

Wipe with damp cloth with no loose hairs, avoid using any chemicals. Please note all finishes are prone to aging.

BUSTER+PUNCH

LONDON

[product.]

3G TOGGLE SWITCH

[range. **ELECTRICITY.**]

[knurl. **CROSS.**]

[detail. **COIN SCREWS.**]

A tactile solid metal toggle switch with diamond-cut knurling.

The switch is finished with a solid metal flat plate and our signature coin screws. Available in four different finishes with a range of detail kits to suit any interior. They can be used in combination with our matching dimmers and outlet options.



[finish. **STEEL.**]

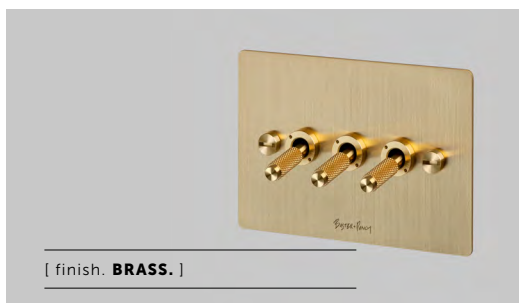

[finish. **BRASS.**]

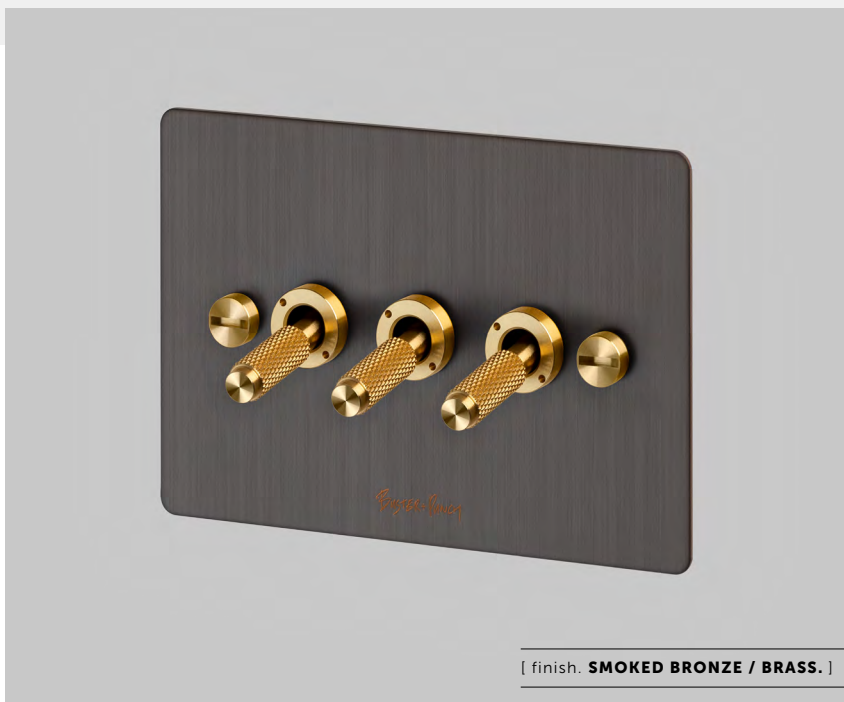

[finish. **SMOKED BRONZE / BRASS.**]



[finish. **SMOKED BRONZE.**]

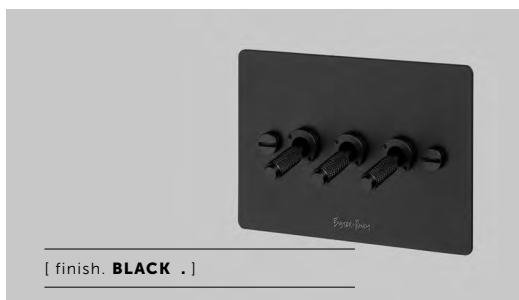

[finish. **BLACK .**]

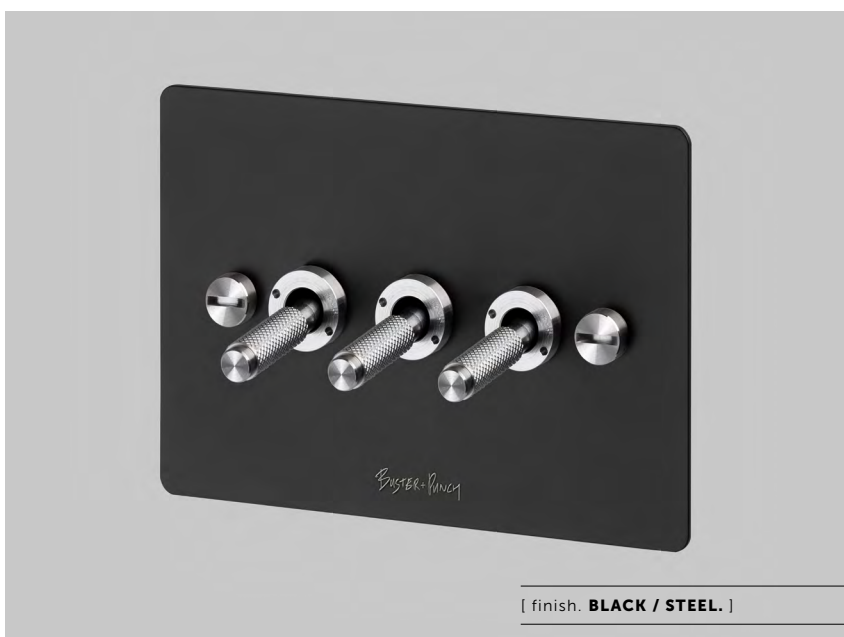

[finish. **BLACK / STEEL.**]

[type. **TOGGLE SWITCH.**]

[info. **MEASUREMENTS.**]

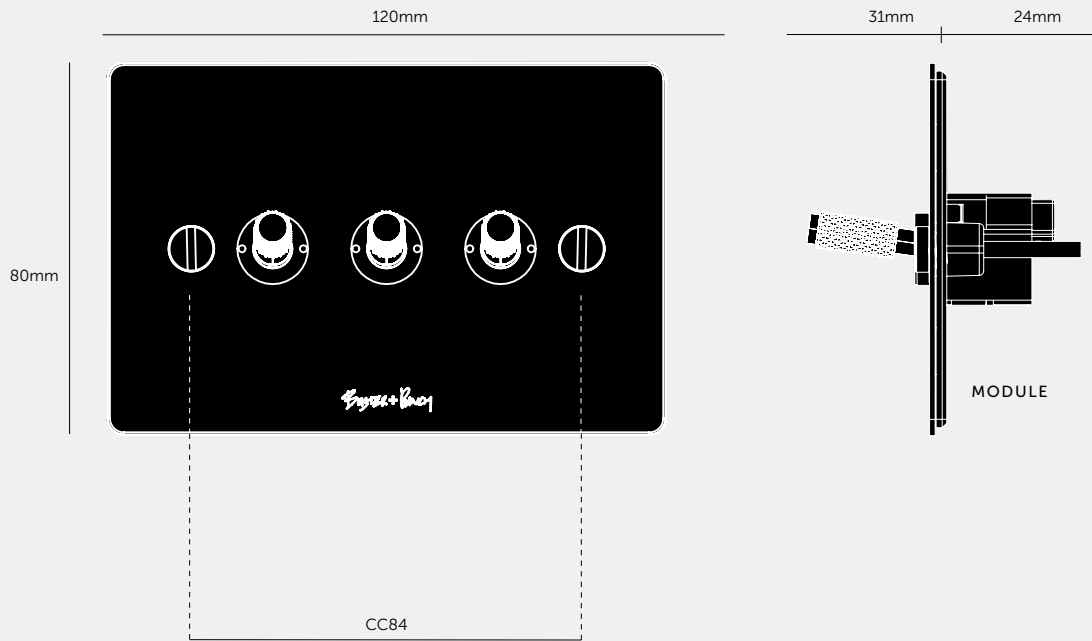

***DETAILS KITS AVAILABLE TO CREATE MIXED FINISHES**

[info. **SPECIFICATIONS.**]

Triple Toggle Switch

Module Code: ZTM-01380

Style: On / Off Toggle Switch

250VAC / 10A

Single Pole / Double Throw

(can be controlled from 2 locations)

Backbox: Standard 2G.





Allow depth of module + sufficient space

for connections when choosing a backbox.

[info. **FINISH & SKU NUMBERS.**]

[finish.]





[sku.]

 Steel	ZTG-07435
 Brass	ZTG-05434
 Smoked Bronze	ZTG-09436
 Black	ZTG-02433

[info. **DETAIL KIT & SKU NUMBERS.**]

[finish.]

[sku.]

 Steel	ZTK-07632
 Brass	ZTK-05631
 Smoked Bronze	ZTK-09633
 Black	ZTK-02630

[info. **CARE INSTRUCTIONS.**]

Wipe with damp cloth with no loose hairs, avoid using any chemicals. Please note all finishes are prone to aging.

BUSTER+PUNCH

LONDON

[product.]

4G TOGGLE SWITCH

[range. **ELECTRICITY.**]

[knurl. **CROSS.**]

[detail. **COIN SCREWS.**]

A tactile solid metal toggle switch with diamond-cut knurling.

The switch is finished with a solid metal flat plate and our signature coin screws. Available in four different finishes with a range of detail kits to suit any interior. They can be used in combination with our matching dimmers and outlet options.

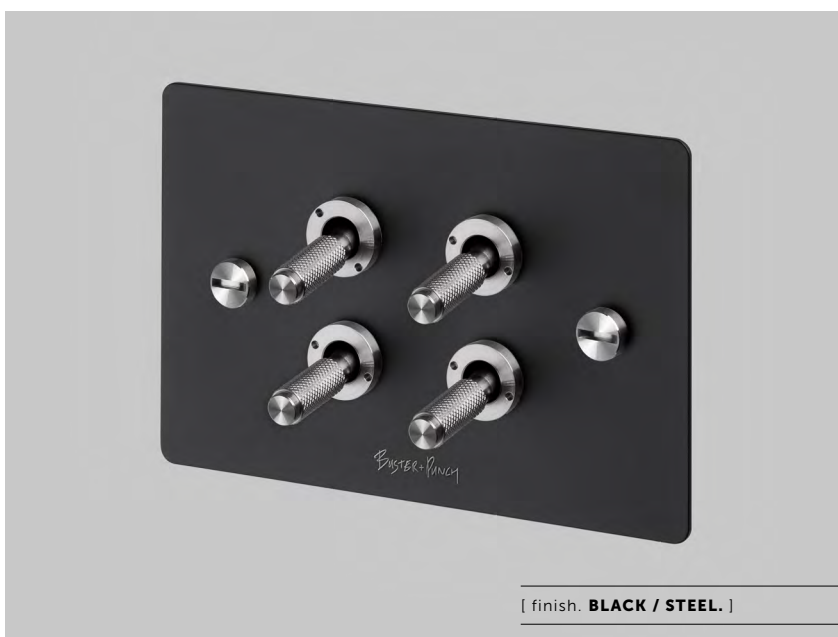
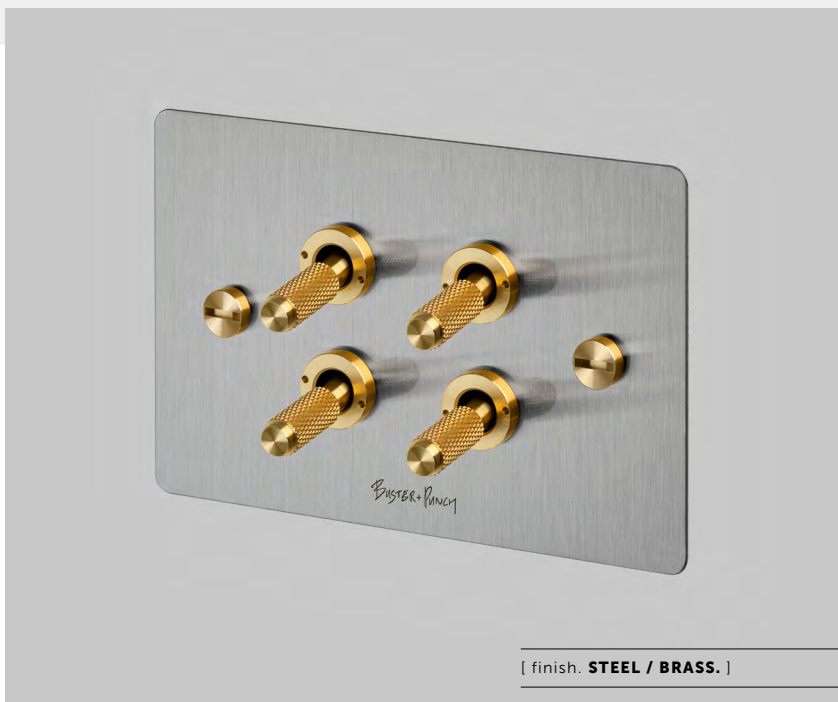
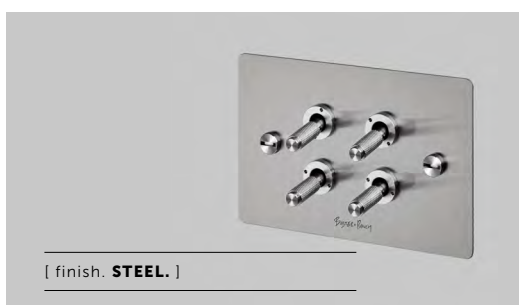

[type. **TOGGLE SWITCH.**]

[info. **MEASUREMENTS.**]

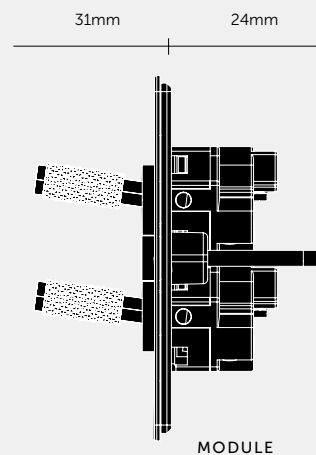
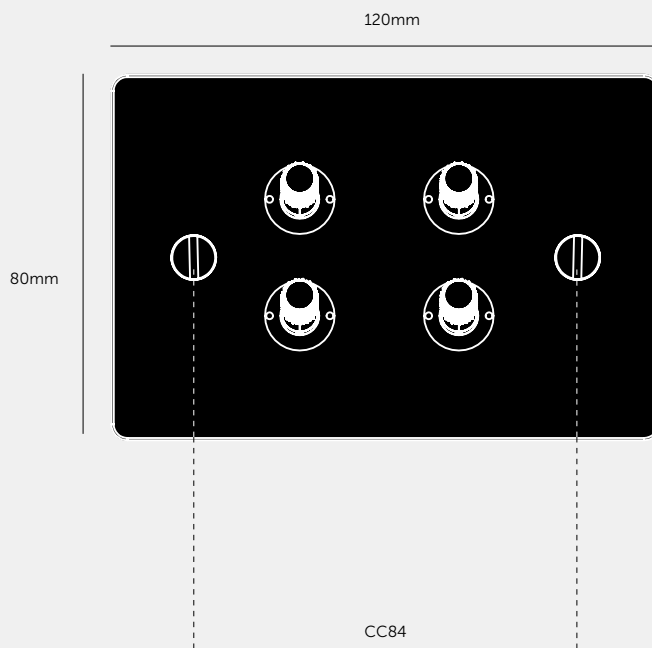

***DETAILS KITS AVAILABLE TO CREATE MIXED FINISHES**

[info. **SPECIFICATIONS.**]

Quadruple Toggle Switch

Module Code: ZTM-01380

Style: On / Off Toggle Switch

250VAC / 10A

Single Pole / Double Throw

(can be controlled from 2 locations)

Backbox: Standard 2G.





Allow depth of module + sufficient space

for connections when choosing a backbox.

[info. **FINISH & SKU NUMBERS.**]

[finish.]





[sku.]

 Steel	ZTG-07440
 Brass	ZTG-05439
 Smoked Bronze	ZTG-09441
 Black	ZTG-02438

[info. **DETAIL KIT & SKU NUMBERS.**]

[finish.]

[sku.]

 Steel	ZTK-07632
 Brass	ZTK-05631
 Smoked Bronze	ZTK-09633
 Black	ZTK-02630

[info. **CARE INSTRUCTIONS.**]

Wipe with damp cloth with no loose hairs, avoid using any chemicals. Please note all finishes are prone to aging.

[type. **SWITCH MODULES.**]

[info. **SPEC SHEET.**]

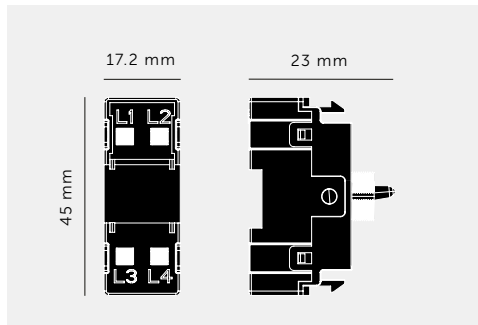

[Finish.]

[SKU.]

[info. **SPECIFICATION.**]

● Black

GZTM-013292

INTERMEDIATE TOGGLE MODULE / 3 WAY

On / Off Toggle Switch
3 Way switching
250 VAC / 10 AX
Certified for use in UK, Europe and Russia :
UKCA / CE / EAC
*Not compatible with retractive switching

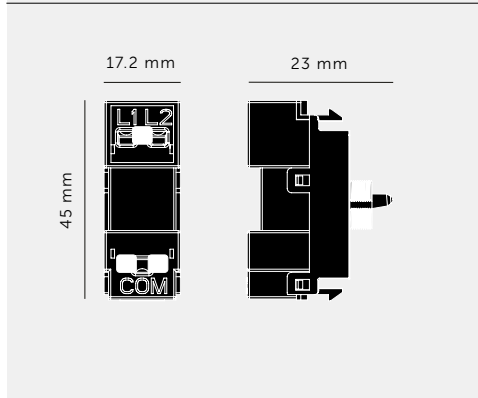

[Finish.]

[SKU.]

[info. **SPECIFICATION.**]

● Black

GZTM-013291

RETRACTIVE TOGGLE MODULE / 2 WAY

Single Throw 2 Way Sprung Return
On / Off Toggle Switch
2 Way switching
250 VAC / 10 A
Certified for use in UK, Europe and Russia :
UKCA / CE / EAC
*Not compatible with regular 2-3 way switching

 smart ready

[please. **NOTE.**]

DISCLAIMER: Always consult a trade professional when installing these modules. Buster + Punch is not responsible for the usage or feasibility of installation requirements. This product is not suitable for damp or wet environments.

HOW TO BUILD YOUR CUSTOM TOGGLE SWITCH

[range. **ELECTRICITY.**]

[knurl. **CROSS.**]

[detail. **COIN SCREWS.**]

All products are available in solid finishes, customisable with interchangeable details kits to suit any interior. Requires appropriate details kit.

1

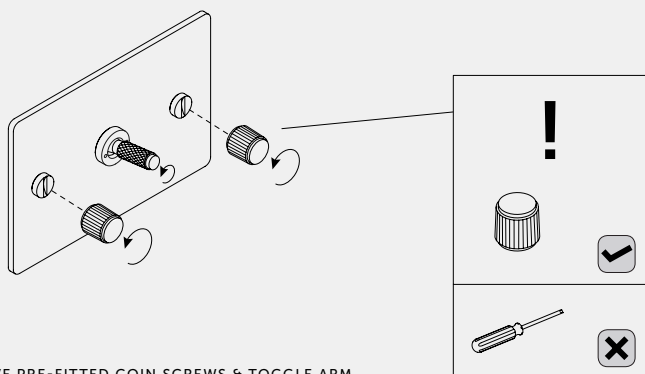

REMOVE PRE-FITTED COIN SCREWS & TOGGLE ARM.

2

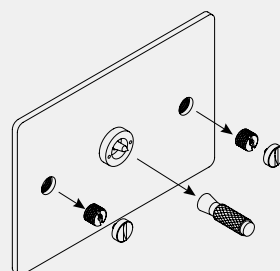

3

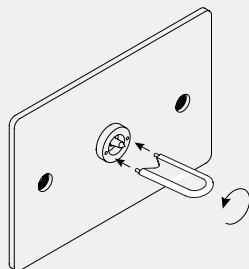

4

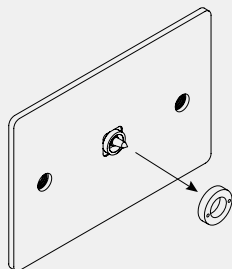

5

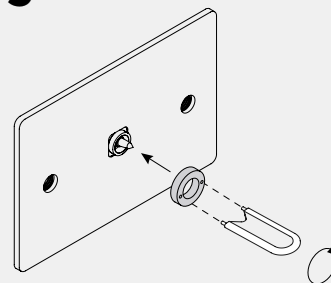

REPLACE WITH COIN SCREWS & TOGGLE ARM FROM YOUR DETAILS KIT.

6

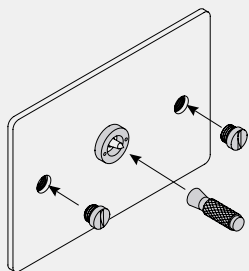

7

