



CATALOGUE 2024

Sabelt

www.sabelt.com

Sabelt

**PERFORMANCE
IS HERE**

 @sabeltofficial
 sabeltofficial
 Sabelt S.p.A.

Sabelt S.p.A.
Via Guido Rossa, 8/10/12
10024 Moncalieri (TO) Italia

Tel. +39 011 6477911
Fax. +39 011 6477999
info@sabelt.com



n°1 in safety since 1972



SABELT
SUSTAINABILITY
REPORT

Sabelt

CATALOGUE 2024



Sabelt®

10
HARNESSES

62
NETS

68
SEATS

110
RACEWEAR

148
STEERING WHEELS

152
ACCESSORIES

THE COMPANY



SINCE 1972



We have provided the top historical car manufacturers with innovative restraint systems for decades.

SAFETY



For Sabelt, safety is of the utmost importance: first in the car, supplying the best seat belts in the world, second for drivers all over categories and championships.



DESIGN



Sabelt offers high performance levels integrated with style and design. Each component is designed and engineered either exclusively by Sabelt in support with external Design&Style centres or in partnership with the client.

INNOVATION



We transform ideas into products. We collaborate with our customers to study new and better solutions and meet specific needs and new requirements. All our products are the result of a process that brings together various novel ideas with engineering and technology.



Sabelt, founded in 1972 by Piero and Giorgio Marsiaj, specializes in the development and production of car seats for performance road cars, racing products for motor racing and seatbelts for aerospace. The quality of Sabelt products is the result of intense research and development, which allows it to reach the highest levels of performance and safety. Sabelt invests 8% of its resources annually in research and development and is the only company in its sector to have an internal dynamic test laboratory to perform ECE and FIA tests, aimed at verifying the strength and effectiveness of its products.

SUSTAINABILITY

Strive to ensure driver safety and protect human lives: sustainability is part of Sabelt's DNA

Our commitment:



Clean energy production from solar panels



Organizational carbon footprint assessment to achieve carbon neutrality



The code of ethics highlights Sabelt's values



Smart mobility plan and charging columns to reduce road emissions

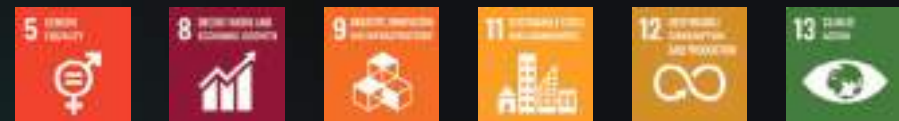
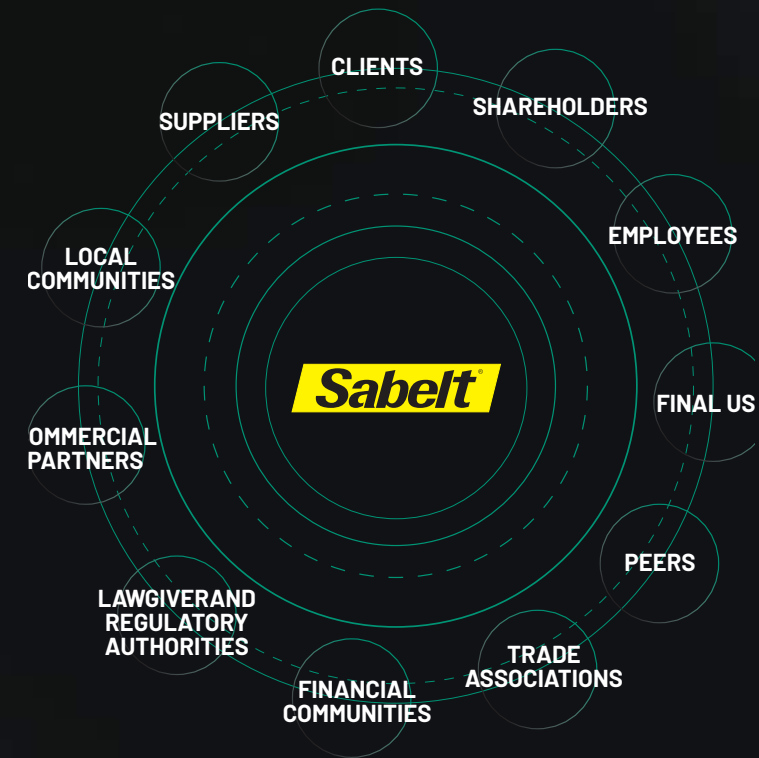

The sustainability report has been voluntarily published since 2019

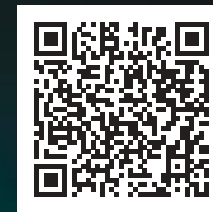

Download our latest sustainability report to learn more

SAFETY AND LABORATORY



The pursuit of safety has played a key role since the foundation of Sabelt. We have been the first to equip the laboratories of our plant with a dynamic test which simulates crashes and pre-homologates products for the strict automotive standards: an innovative system prescribed by ECE and FIA regulations. All tests are conducted with the specific intent to maintain a bigger margin to the minimum required, with outstanding performance levels built with style and design.

PRODUCTION



All Sabelt products are designed and engineered exclusively by Sabelt in the operational headquarters in Turin, in collaboration with external design centers or in partnership with clients car makers.

AUTOMOTIVE SEATING



From the world of motorsport, Sabelt has developed a range of premium sports seats for the world's top car manufacturers. It designs and manufactures safety belts and seats for vehicles with a strong sporting connotation, dedicated to an advanced and demanding driver, that is sports oriented and has a particular attention to quality. Its main partners are: Ferrari, McLaren, Alpine, Abarth, Alfa Romeo, Jaguar, Cupra, Maserati and Aston Martin.

AEROSPACE AND DEFENSE



Sabelt is able to develop and implement new technologies dedicated to various applications of safety seatbelts in niche markets, such as the military, aviation, aerospace, exceptional transport and many other fields where technical and customized products are required. Since 2010, Sabelt has been the supplier of Thales Alenia Space Italia for the restraint systems of the Cygnus Orbital-ATK module (belts and nets).

HARNESSES



Alfa Romeo
F1 TEAM
OFFICIAL PARTNER

Image from 2023

FIA 8853-2016

GT / RALLY



WRC HARNESS



CFCI4428G632SD7F



CFCI42170068



CFCI4210A622SD2F



CFCI4210A622SU2F



CFCI4335A633SU2F



CFCI22100165



CFCI22100162



CFCI22100167



CFCI4335S632SD2F



CFCI4210S622SU2F



CFCI4335S633SU2F

FORMULA



F1 HARNESS



CFCI4397G832FU6F



CFCI4393G622FU6F



CFCI4350A622FU3F



CFCI4350S622FU3F



CFCI43500059

SFI 16.1



CFCI2556S622SU2S



CFCI2000S533SD8S

FIA 8854/98

GT / RALLY



CFCI4118A433SD4F



CFCI4118S433SD4F



CFCI4118S433SU4F



CFCI2000A422SD3F (NO FIA)

RACING NET



CFRN2010



CFRN2012

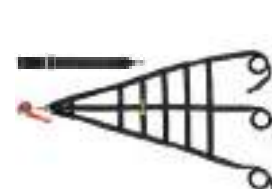

CFRN2008



CFRN2003



CFRN2027 NEW



CFRN2002

ECE 16

CLUBMAN



CFCC4046 (NO ECE)



CFCC904001NP_A



CFCC904070NP_B



CFCC904059NP_B



CFCC904005N_B



CFCC904002N_A

WINDOW NET



Z280988

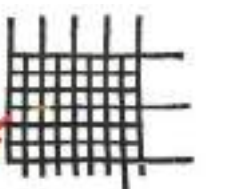

Z280985

BUCKLES

**B1**

Tongues entry designed to simplify the driver fastening. Machined from solid aluminium.

**B5**

Tongues entry designed to simplify the driver fastening. Quick release with spring ejectors. 255 g

**B2**

With integrated crotch belt "T" type attachment. Aluminium. Patented buckle. 219 g

**B6**

Developed with Formula 1 Teams. Superlight buckle in machined from solid aluminium.

**B3**

For "Formula" safety belt developed in Formula 1. Aluminium. Protection for the lever. 192 g

**B4**

Buckle for 4 points safety belt. Aluminium. 184 g

**B7**

Developed for Endurance applications. 2019 and 2021 24h Le Mans winner. 266 g

**B8**

Latch buckle with leather pad and adjuster. 514 g

ADJUSTERS

**A9**

2" Quick release adjuster machined from solid aluminium. Developed in Formula1. 54 g

**A10**

2" Quick release adjuster machined from solid aluminium. Developed for double shoulder belt. 74 g

**A1**

Quick release adjuster for 3" webbing. Forged and anodized aluminium. 2021 24h Le Mans winner. 95 g

**A2**

Quick release adjuster for 2" webbing. Forged and anodized aluminium. 70 g

**A13**

Aluminium quick adjuster 2" with webbing guide. 2019 24h Le Mans winner. 78 g

**A16**

Lap strap tongue with integrated adjuster for 2" width webbing. Steel. 2021 24h Le Mans winner. 113 g

**A3**

Adjuster integrated to the buckle tongue designed for 2" webbing. Developed for GT/Endurance cars. Steel-aluminium. 2019 24h Le Mans winner. 123 g

**A4**

Adjuster for 2" webbing. Steel-aluminium. 113 g

**A5**

"America" adjuster for 3" webbing. Steel. 147 g

**A6**

"America" adjuster for 2" webbing. Steel. 94 g

**A14**

"Tribar" adjuster for 2" webbing. Steel. 80 g

**A7**

"Tribar" adjuster for 3" webbing. Steel. 110 g

**A8**

"Tribar" adjuster for 2" webbing. Steel. 80 g

**A12**

"Bufflug" steel adjuster. 63 g

**A11**

Steel "Stop" adjuster for 2" webbing. 24 g

**A15**

Ergal "Tribar" adjuster for 3" webbing. 64 g

FIXINGS

**F1**

Carabiner. Inox Steel. 24 g

**F2A**

Snap hook in combination with A7 or A8. Steel. 77 g

**F2B**

Sewn snap hook. Steel. 77 g

**F3A**

Fixing plate in combination with A7 or A8. Steel. 63 g

**F3B**

Sewn fixing plate. Steel. 63 g

**F4**

Sewn "P" type steel fixing plate. 47 g

**F5**

"Wrap around" fixing in combination with A7 or A8.

**F6**

"Sewn loop" fixing.

**F7**

Titanium double fixing plate for 2" webbing. For M8 screw. 38 g

**F8**

Small Sewn fixing plate. 45 g

**F9**

Small fixing plate. 44 g

**F10**

Double hole fixing plate. 38 g

**F11**

Sewn double hole fixing plate. 38 g

**F12**

X2 double hole fixing plate. 76 g

TONGUES

**T1**

Lap belt tongue with ergonomic bend. Steel. 32 g

**T2**

Shoulder belt tongue for 3" webbing. Steel. 30 g

**T3**

Shoulder belt tongue for 2" webbing. Steel. 23 g

**T4**

Titanium mini-tongue for CCG622FSR, CCG832FSR harnesses. 7 g

**T5**

Titanium tongue for E1 harnesses. 9 g

**T6**

Lap belt tongue with ergonomic bend. Titanium. 18 g

**T7**

Steel shoulder belt tongue +5 mm. 38 g

**T8**

Lap strap link. 86 g

**T9**

Left shoulder strap link. 69 g

**T10**

Right shoulder strap link. 69 g

**T11**

Crotch strap link. 57 g

OPTIONALS

**O2**

Logo printed directly on the webbing in high grip material for FHR.

**O4**

Closure velcro for adjustable straps.

**O5**

Ergonomic handle.

**O6**

Intercom or Drink System cord.

**O7**



Velcro on upper shoulder belt.

**O8**

Vintage logo

GOLD Endurance

STANDARD FEATURES

GT/RALLY				GOLD	FIA 8853-2016		
STANDARD MEASURES (mm)				STANDARD COLOURS/CODES			
A	B	C	D				
430	790	620	330	CFCI4428G632SD7F	CFCI2428G632SD7F	CFCI1428G632SD7F	



CFCI4428G632SD7F

CONFIGURATIONS ON DEMAND (See details at page 19)

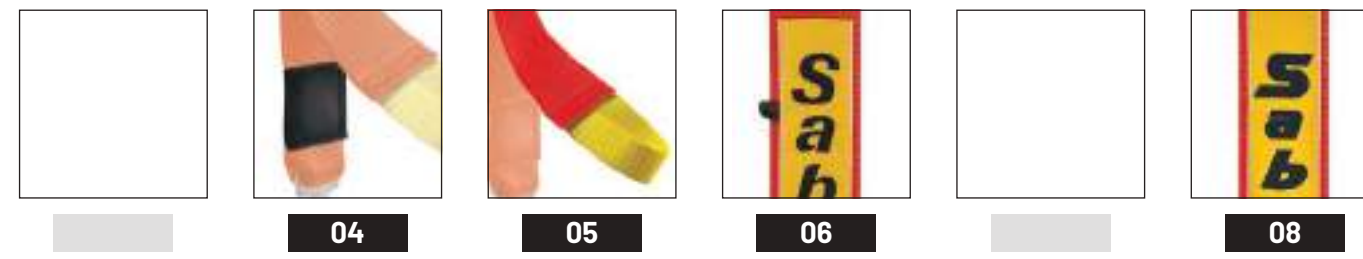



MANUFACTURER: SABELT
 MODEL: ENDURANCE
 HOM. NO: SH.064.19-T-6
 FIA STANDARD: 8853-2016

SILVER LPM

CFCI42170068

STANDARD FEATURES

CONFIGURATIONS ON DEMAND (See details at page 19)

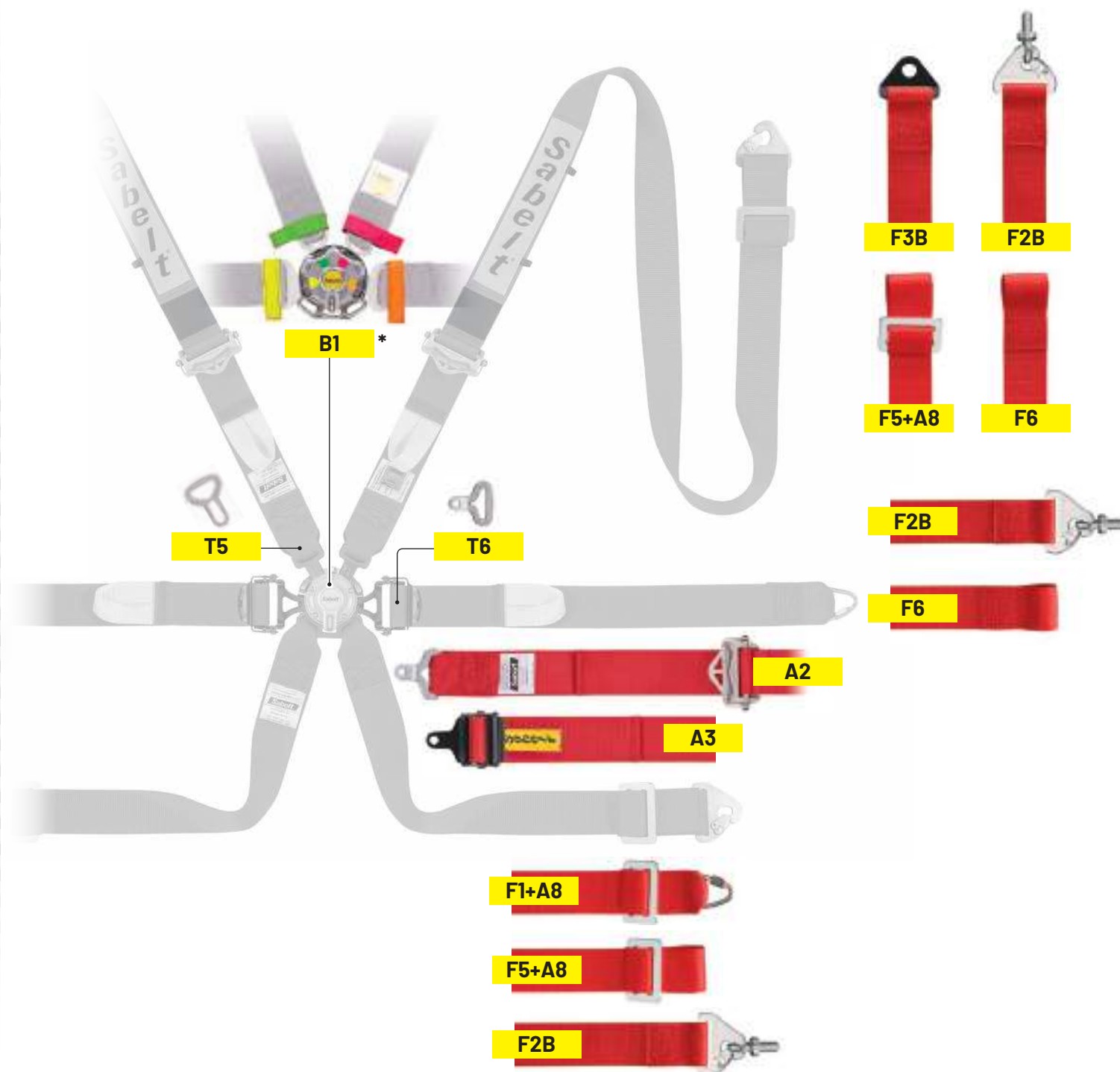
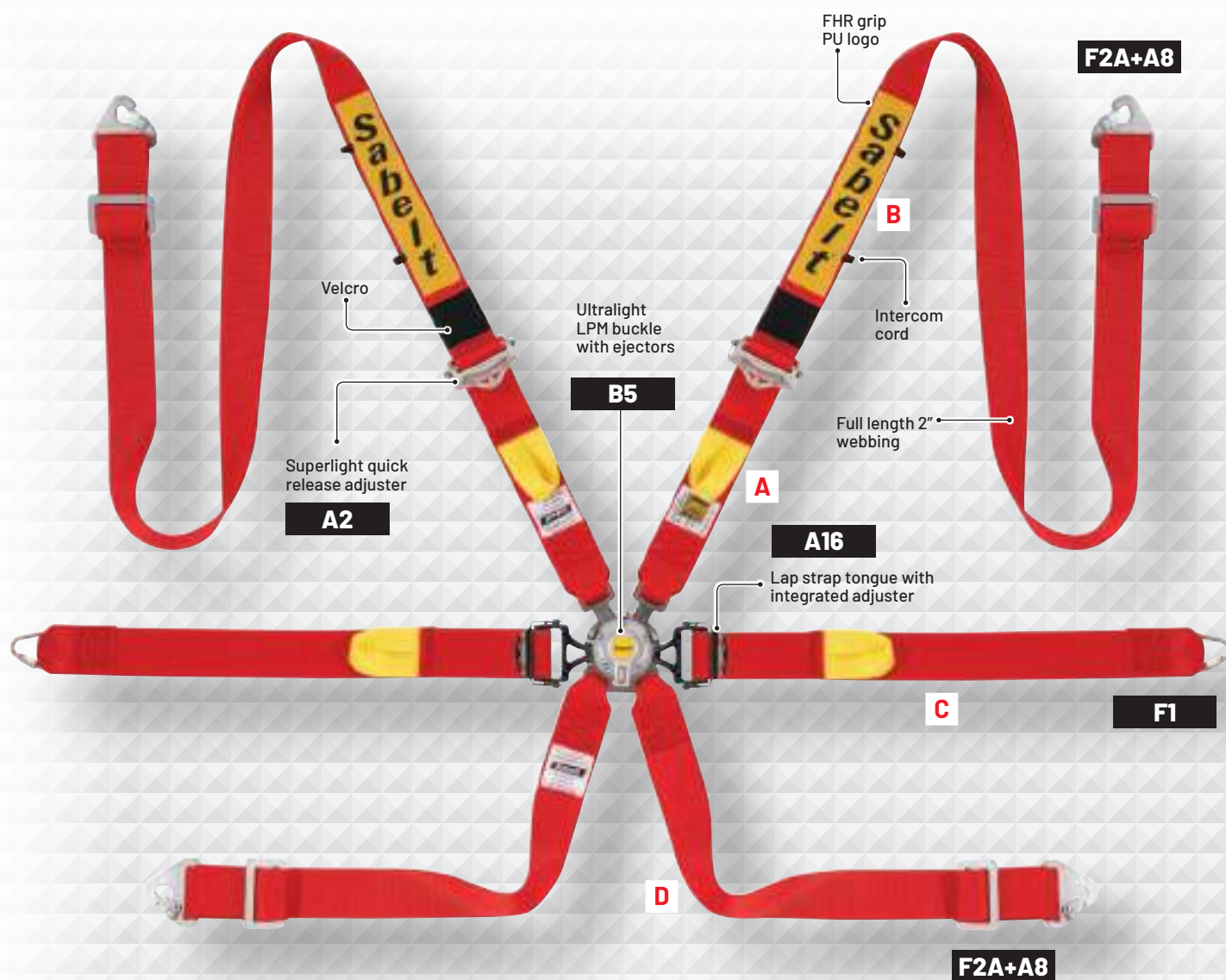
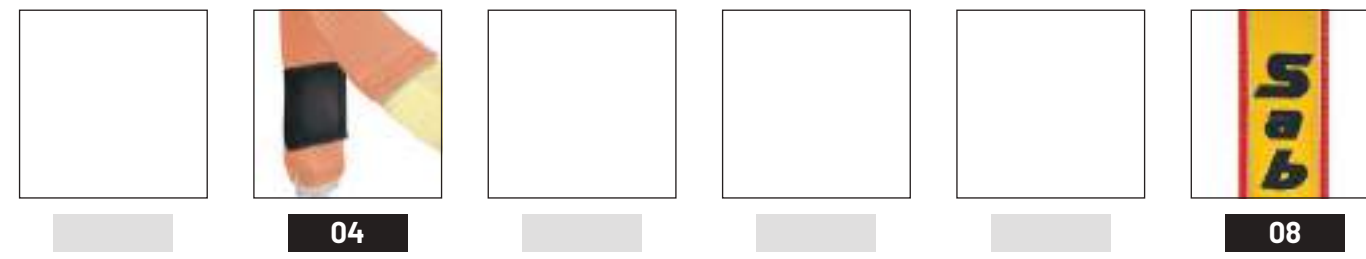

GT/RALLY				SILVER	FIA 8853-2016	
STANDARD MEASURES (mm)				STANDARD COLOURS/CODES		
A	B	C	D			
380	1700	680	850	CFCI42170068	CFCI22170068	CFCI12170068



* Gadget kit not included.

SILVER Endurance

STANDARD FEATURES

GT/RALLY				SILVER	FIA 8853-2016	
STANDARD MEASURES (mm)				STANDARD COLOURS/CODES		
A	B	C	D			
380	1700	680	850	CFCI4210A622SD2F	CFCI2210A622SD2F	CFCI1210A622SD2F

CFCI4210A622SD2F

CONFIGURATIONS ON DEMAND (See details at page 19)

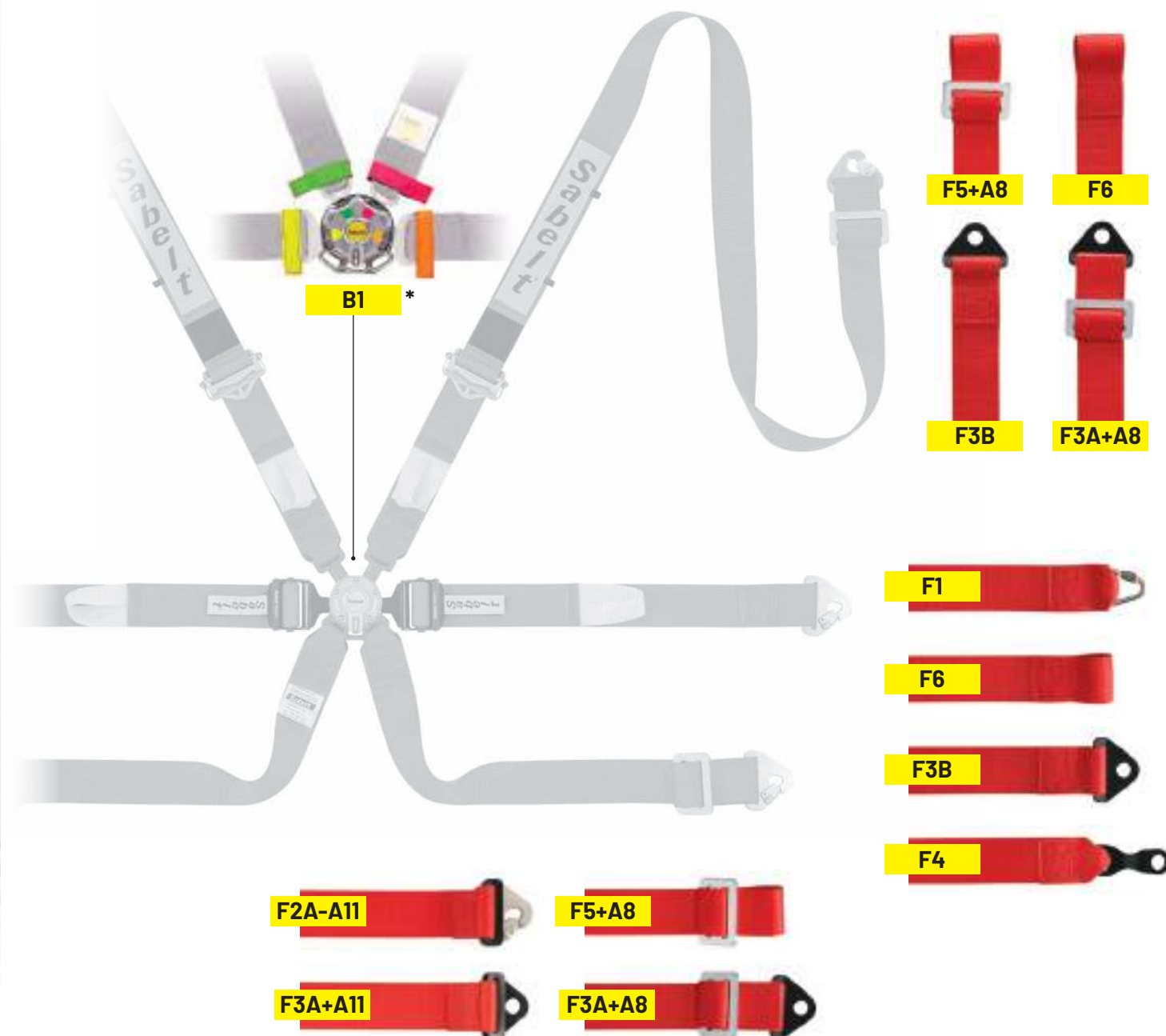
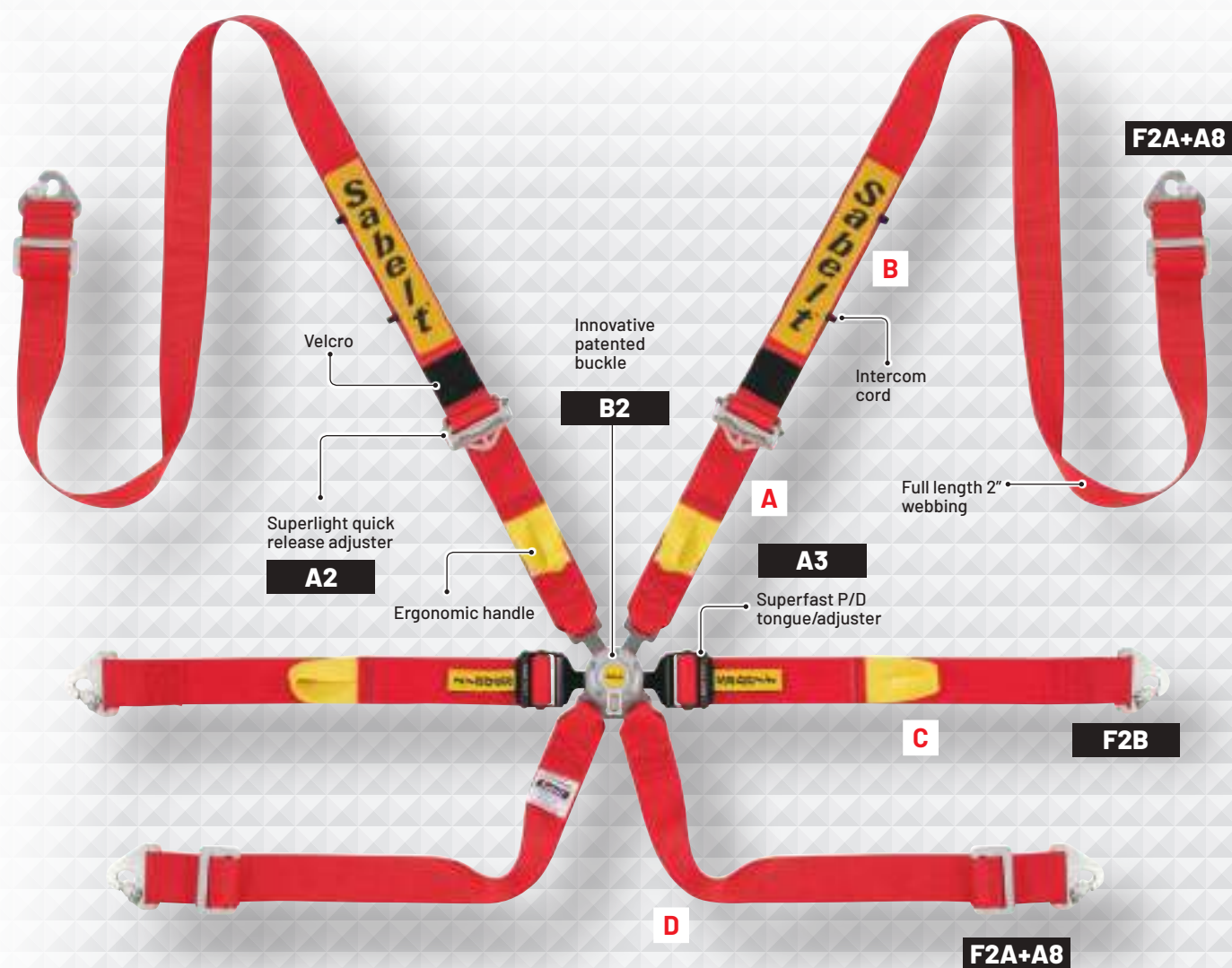
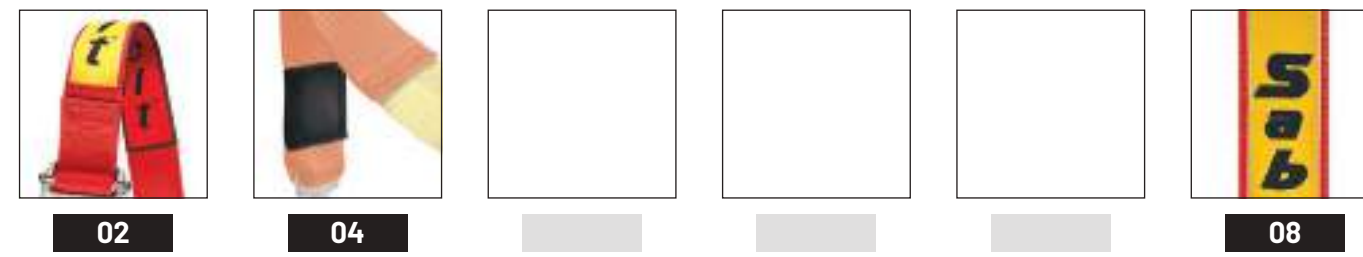

MANUFACTURER: SABELT
 MODEL: NEW SPEC SALOON
 HOM. NO: SH.001.16-T-6
 FIA STANDARD: 8853-2016



* Gadget kit not included.



Ferrari AF Corse – LMH WEC

SILVER GT 997 911 GT3

CFCI22100165 - STANDARD FEATURES

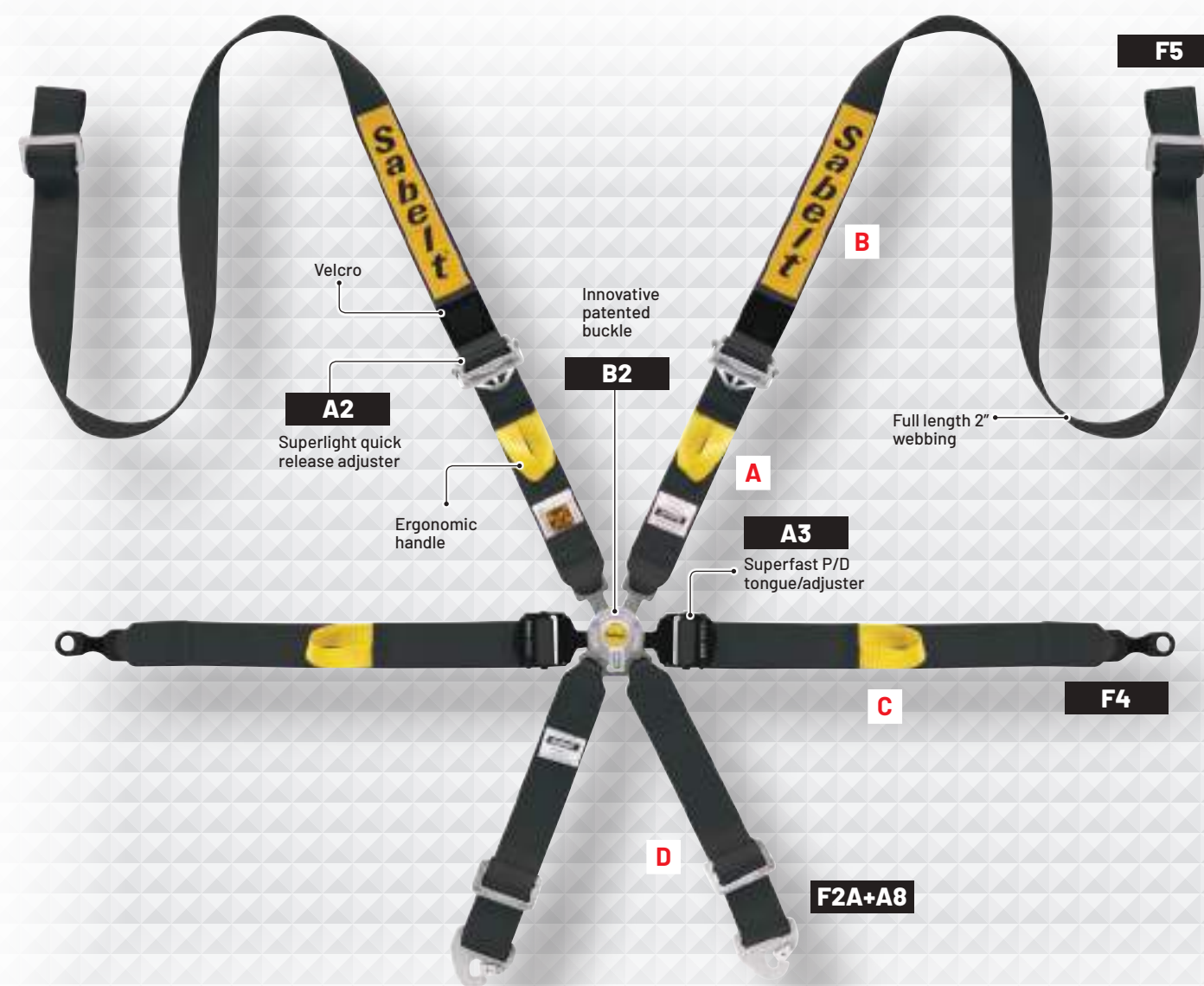

GT				SILVER	FIA 8853-2016	
STANDARD MEASURES (mm)				STANDARD COLOURS/CODES		
A	B	C	D			
360	1700	720	390	CFCI42100165	CFCI22100165	CFCI12100165



MANUFACTURER: SABELT
 MODEL: NEW SPEC SALOON
 HOM. NO: SH001.16-T-6
 FIA STANDARD: 8853-2016

SILVER GT 991-984 GT4

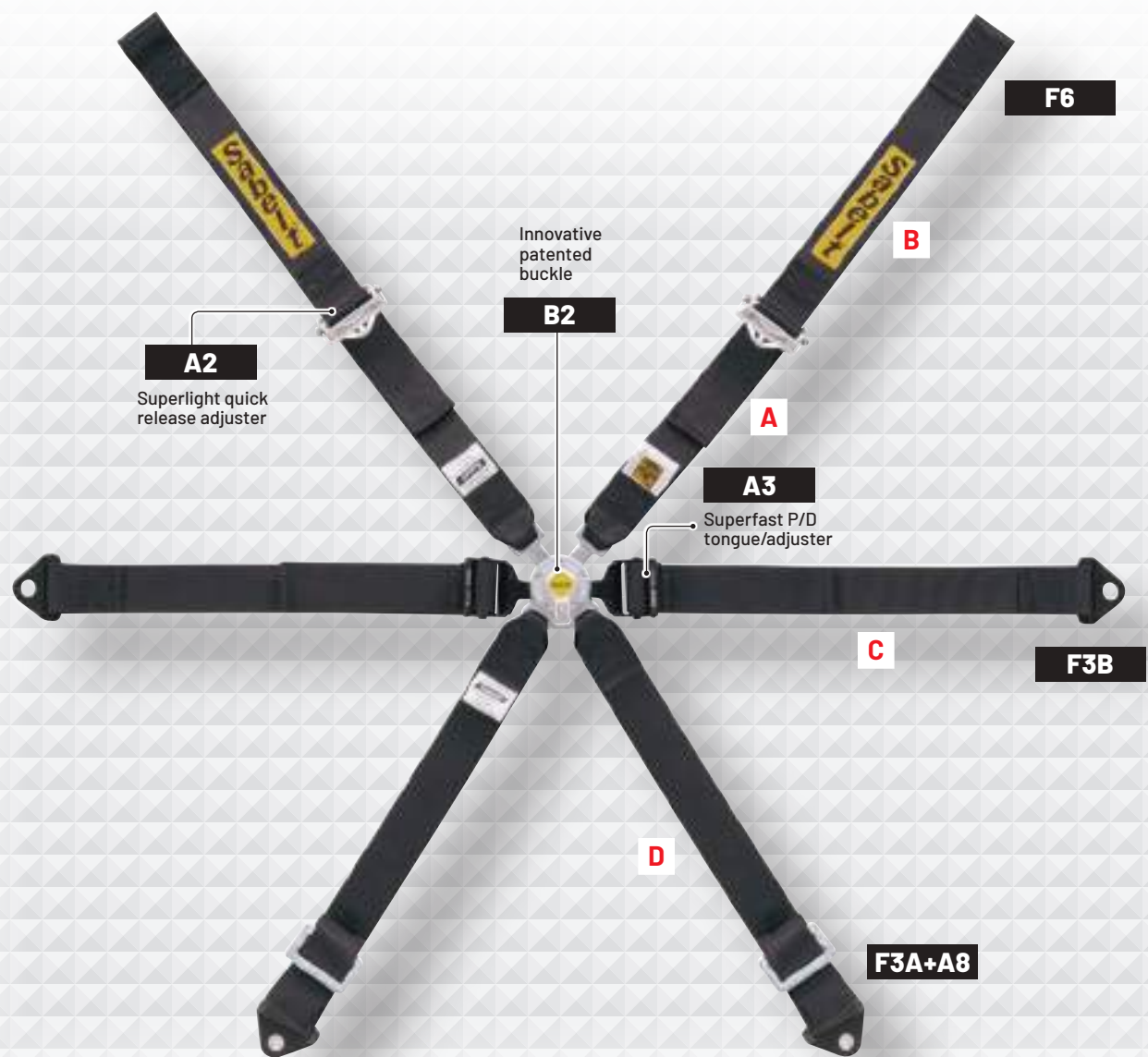

CFCI22100162 - STANDARD FEATURES

GT				SILVER	FIA 8853-2016		
STANDARD MEASURES (mm)				STANDARD COLOURS/CODES			
A	B	C	D				
450	380	700	765	CFCI42100162	CFCI22100162	CFCI12100162	



SILVER Enduro 997 911 GT3

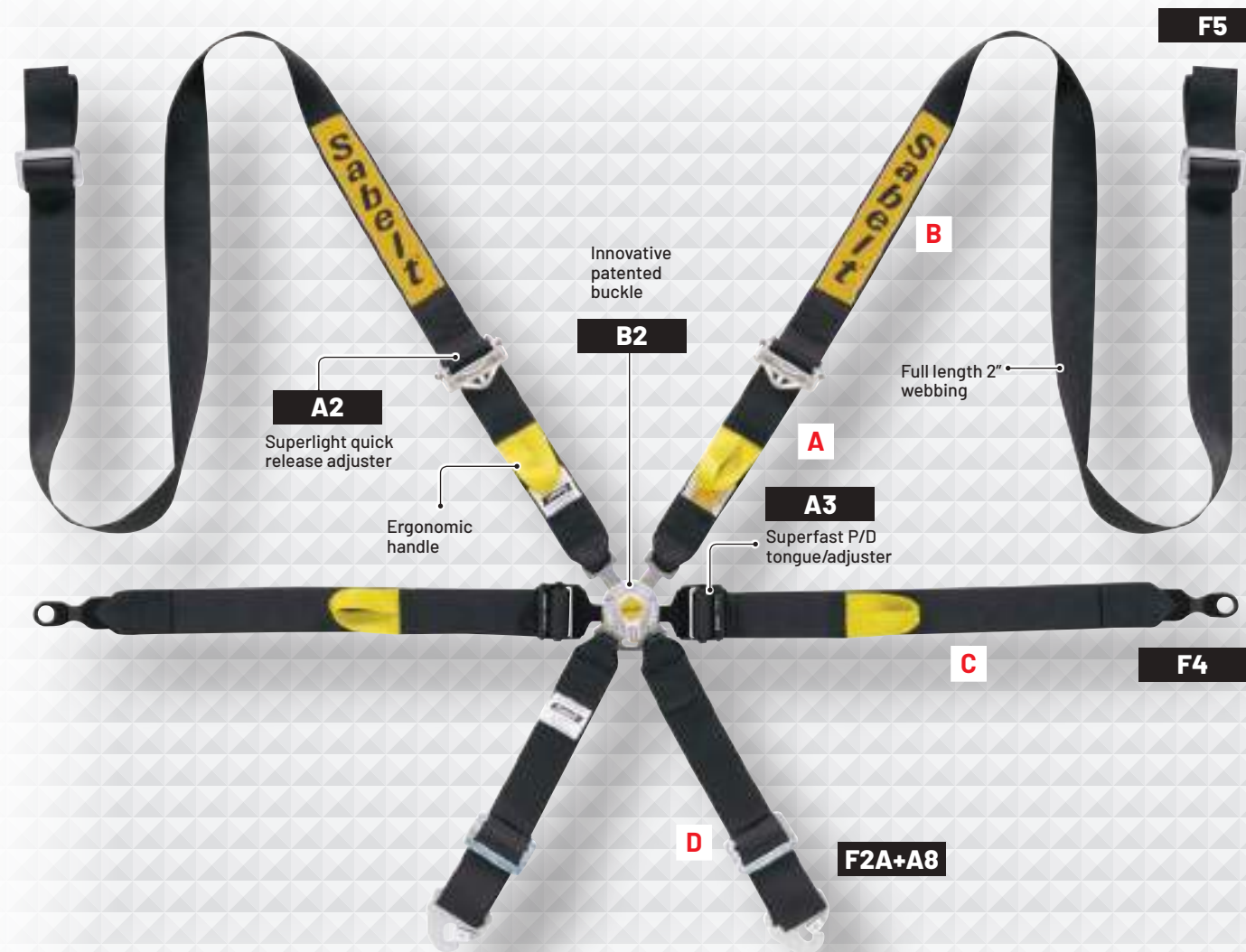

CFCI22100167 - STANDARD FEATURES

GT				SILVER	FIA 8853-2016		
STANDARD MEASURES (mm)				STANDARD COLOURS/CODES			
A	B	C	D				
360	1700	720	390	CFCI42100167	CFCI22100167	CFCI12100167	



SILVER Rally

STANDARD FEATURES

GT/RALLY				SILVER	FIA 8853-2016	
STANDARD MEASURES (mm)				STANDARD COLOURS/CODES		
A	B	C	D			
380	1700	560+120	850	CFCI4210A622SU2F	CFCI2210A622SU2F	CFCI1210A622SU2F

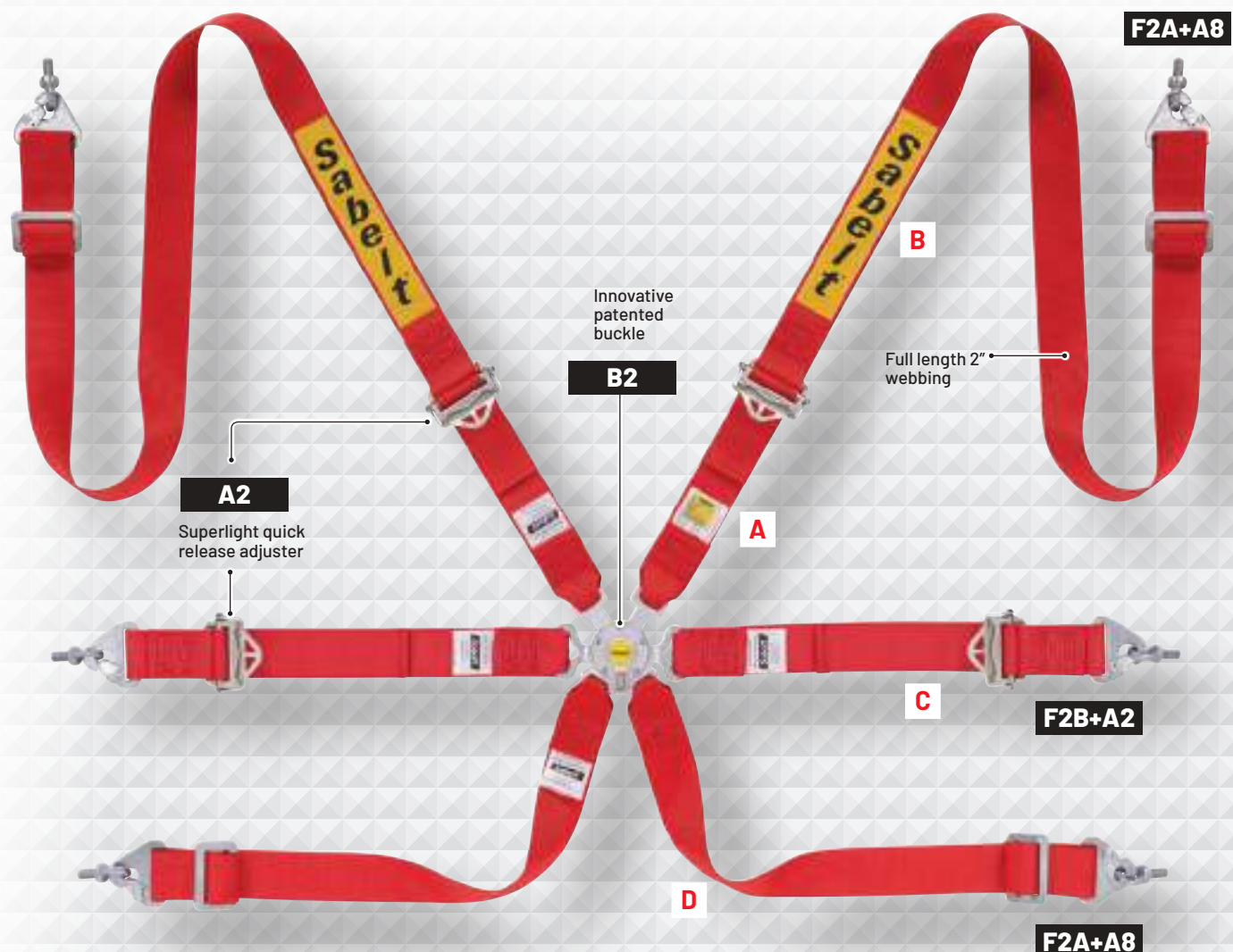

CFCI4210A622SU2F

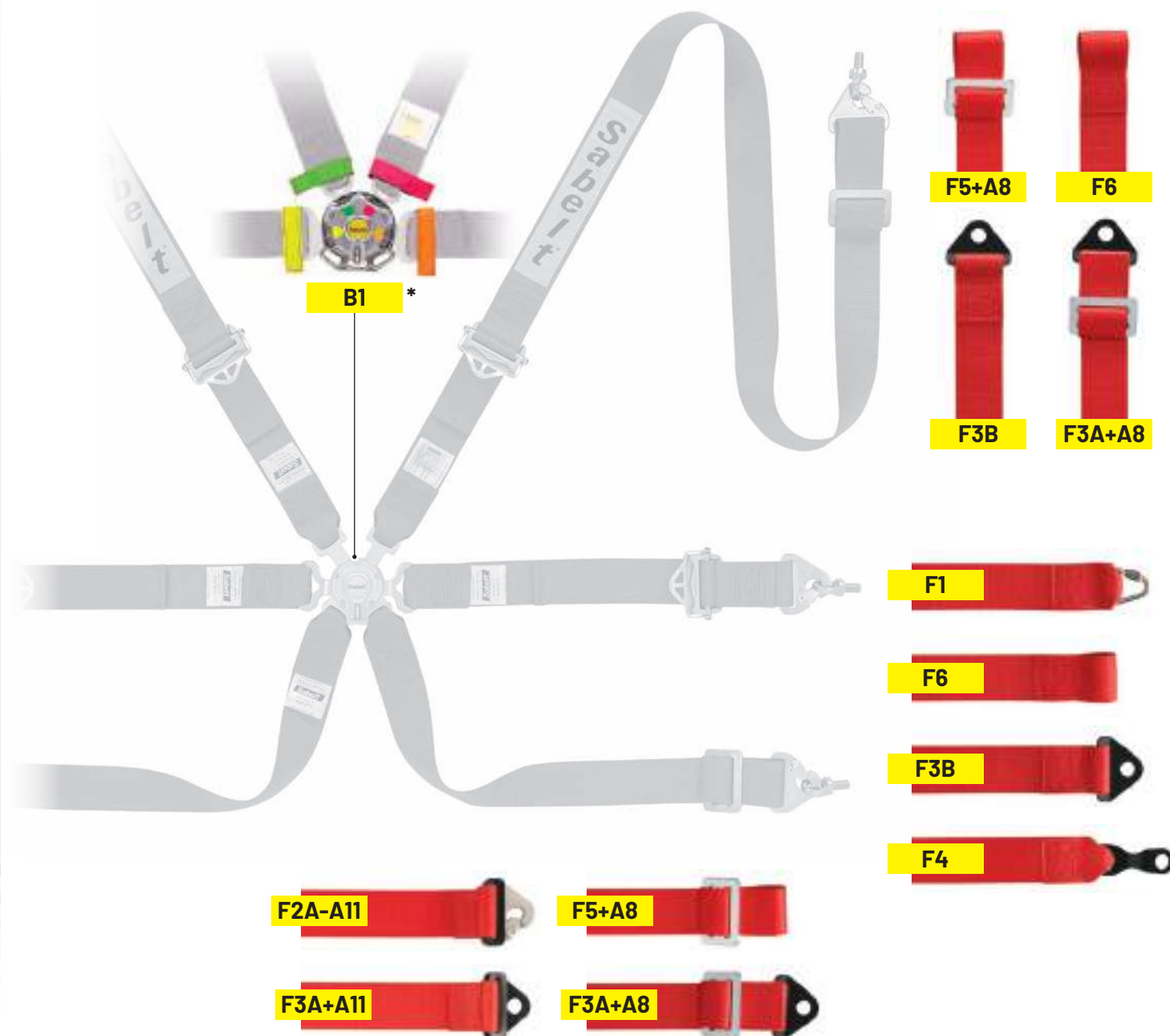
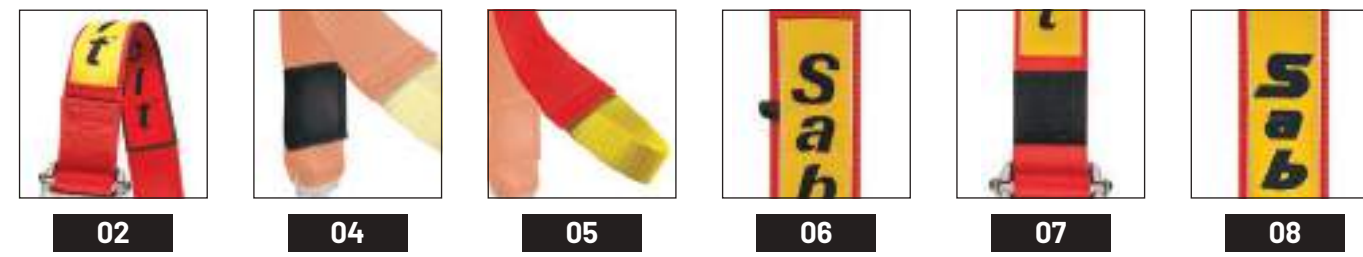

CONFIGURATIONS ON DEMAND (See details at page 19)



* Gadget kit not included.

SILVER Rally 3x3

STANDARD FEATURES

GT/RALLY				SILVER	FIA 8853-2016	
STANDARD MEASURES (mm)				STANDARD COLOURS/CODES		
A	B	C	D			
380	1700	560+120	850	CFCI4335A633SU2F	CFCI2335A633SU2F	CFCI1335A633SU2F

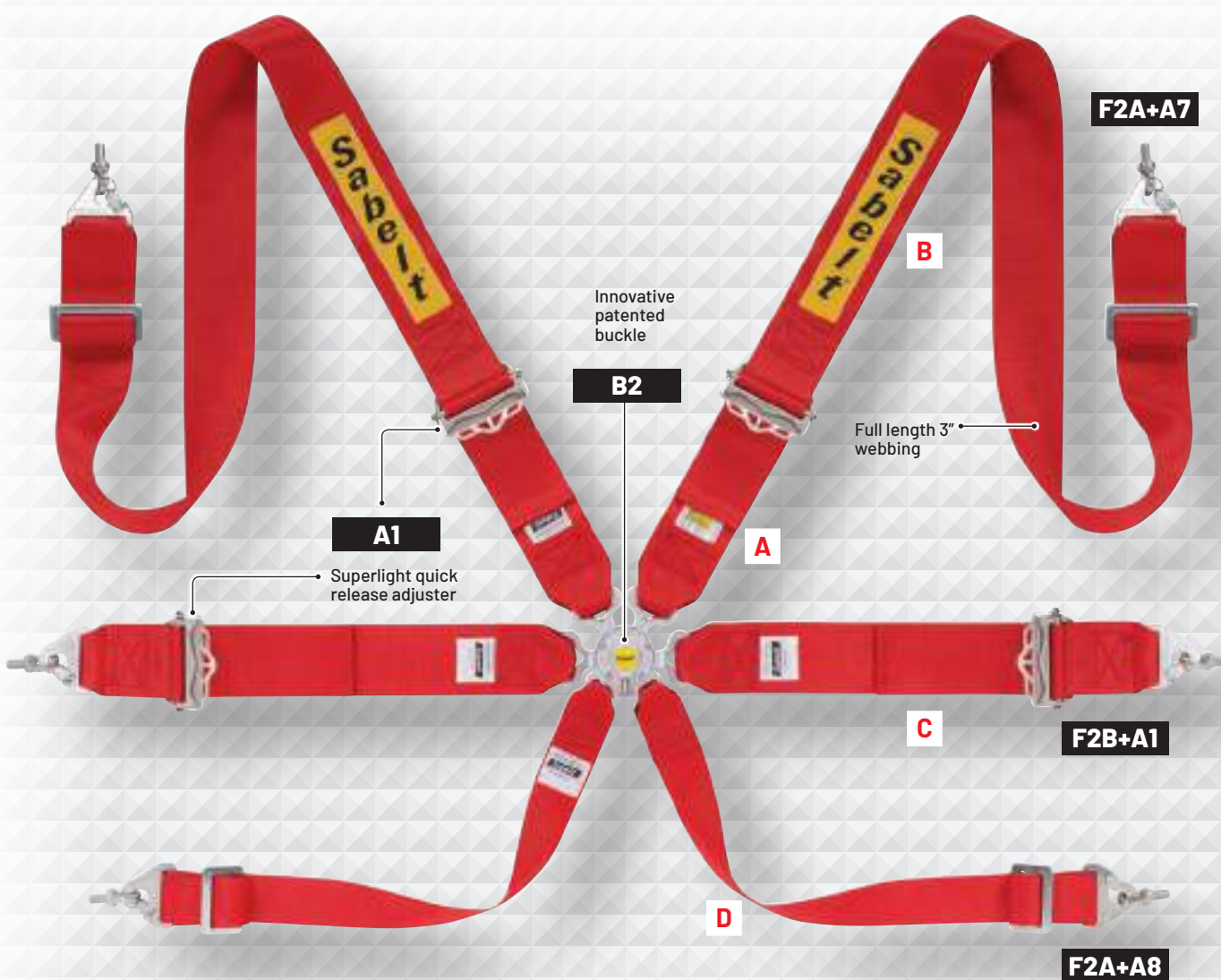

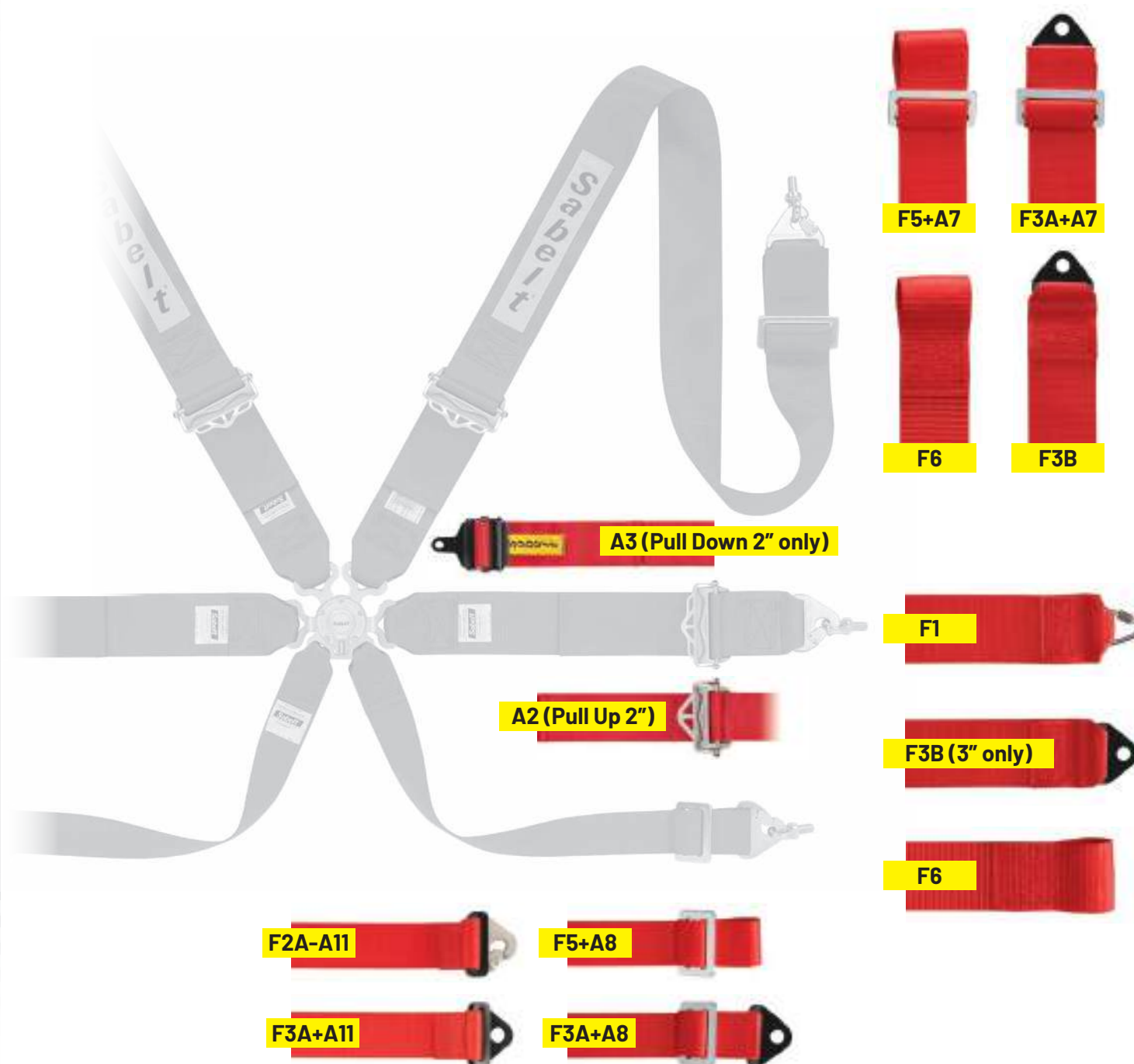
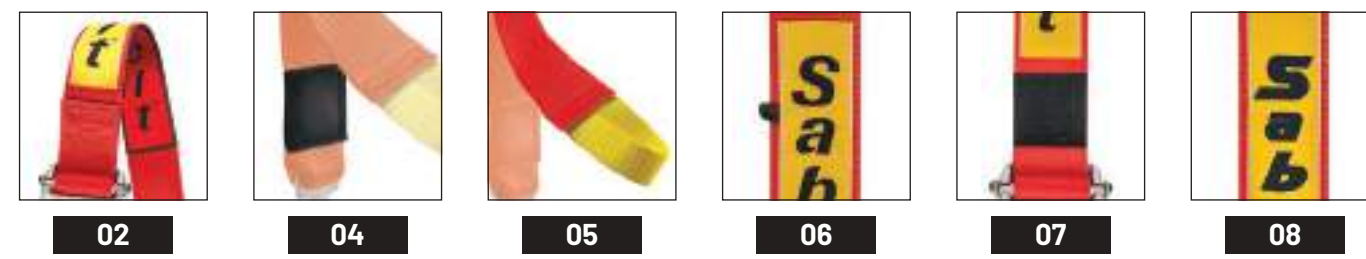

CFCI4335A633SU2F

CONFIGURATIONS ON DEMAND (See details at page 19)



STEEL Rally 3x2

STANDARD FEATURES

GT/RALLY				STEEL	FIA 8853-2016		
STANDARD MEASURES (mm)				STANDARD COLOURS/CODES			
A	B	C	D				
380	1700	680	850	CFCI4335S632SD2F	CFCI2335S632SD2F	CFCI1335S632SD2F	





CFCI4335S632SD2F

CONFIGURATIONS ON DEMAND (See details at page 19)



STEEL Rally

STANDARD FEATURES

GT/RALLY				STEEL	FIA 8853-2016	
STANDARD MEASURES (mm)				STANDARD COLOURS/CODES		
A	B	C	D			
380	1700	560+120	850	CFCI4210S622SU2F	CFCI2210S622SU2F	CFCI1210S622SU2F

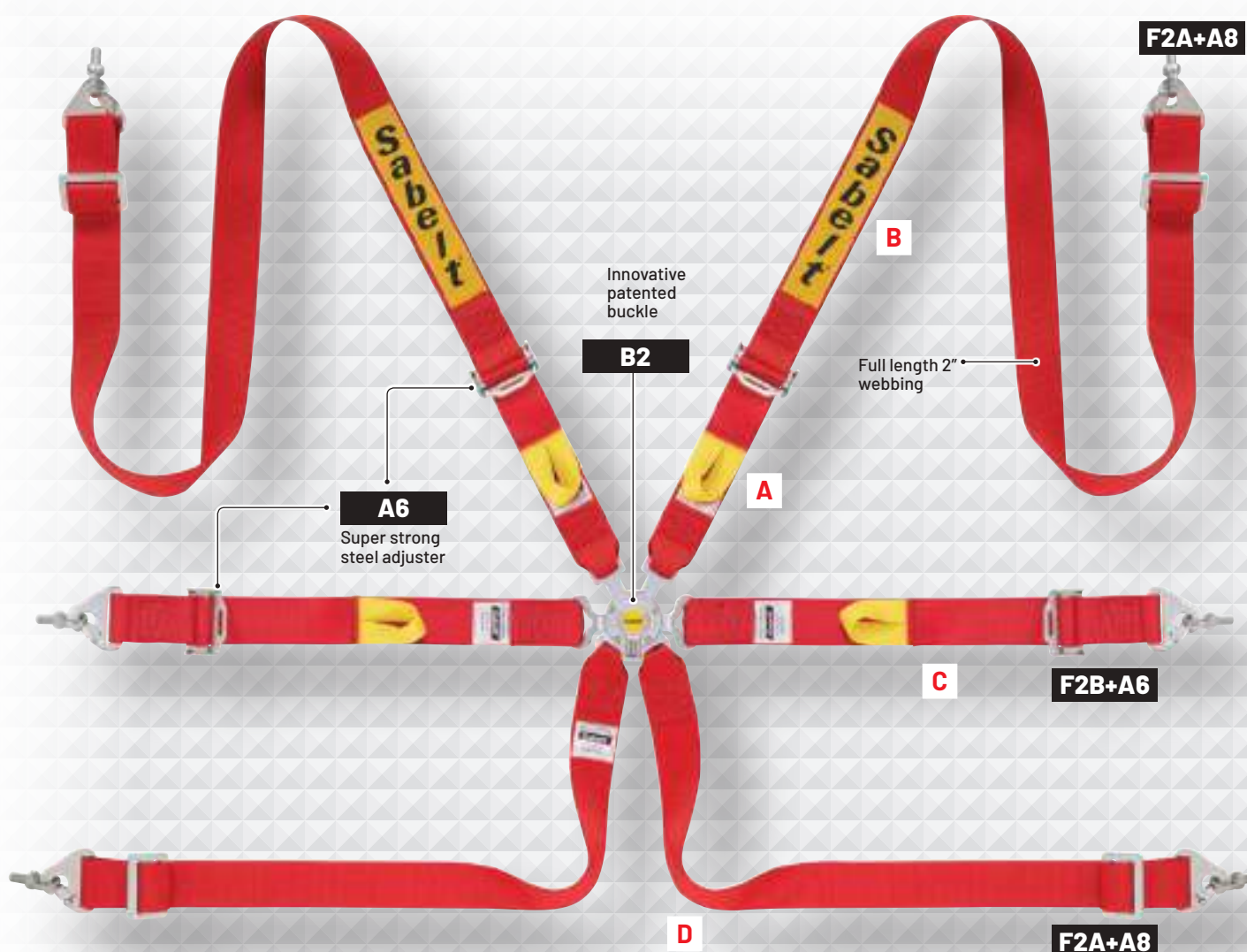

CFCI4210S622SU2F

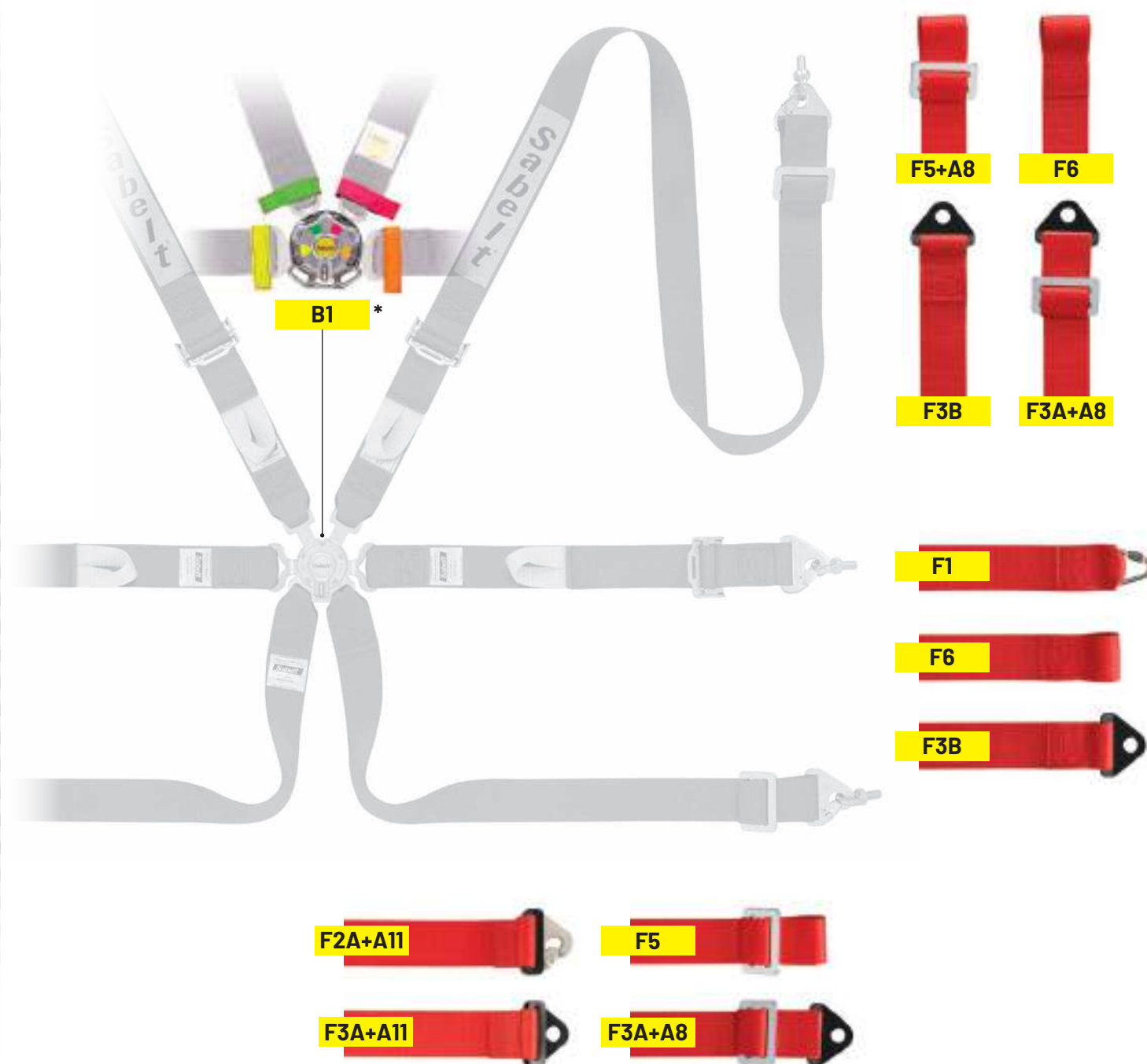

CONFIGURATIONS ON DEMAND (See details at page 19)



* Gadget kit not included.

STEEL Rally 3x3

STANDARD FEATURES

GT/RALLY				STEEL	FIA 8853-2016	
STANDARD MEASURES (mm)				STANDARD COLOURS/CODES		
A	B	C	D			
380	1700	560+120	850	CFCI4335S633SU2F	CFCI2335S633SU2F	CFCI1335S633SU2F



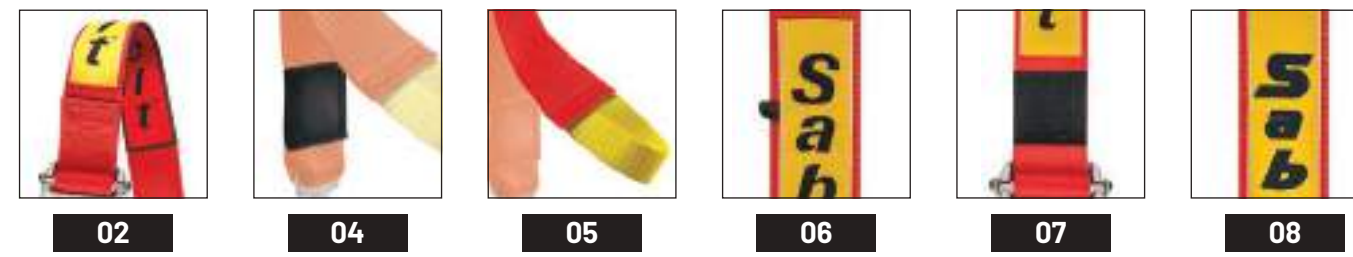

CFCI4335S633SU2F

CONFIGURATIONS ON DEMAND (See details at page 19)



GOLD Superformula 8p

CFCI4397G832FU6F - STANDARD FEATURES

FORMULA					GOLD	FIA 8853-2016		
STANDARD MEASURES (mm)					STANDARD COLOURS/CODES			
A	B2	B3	C	D				
360	495+105	430	975 FULL Length	960 FULL Length	CFCI4397G832FU6F	CFCI2397G832FU6F	CFCI1397G832FU6F	

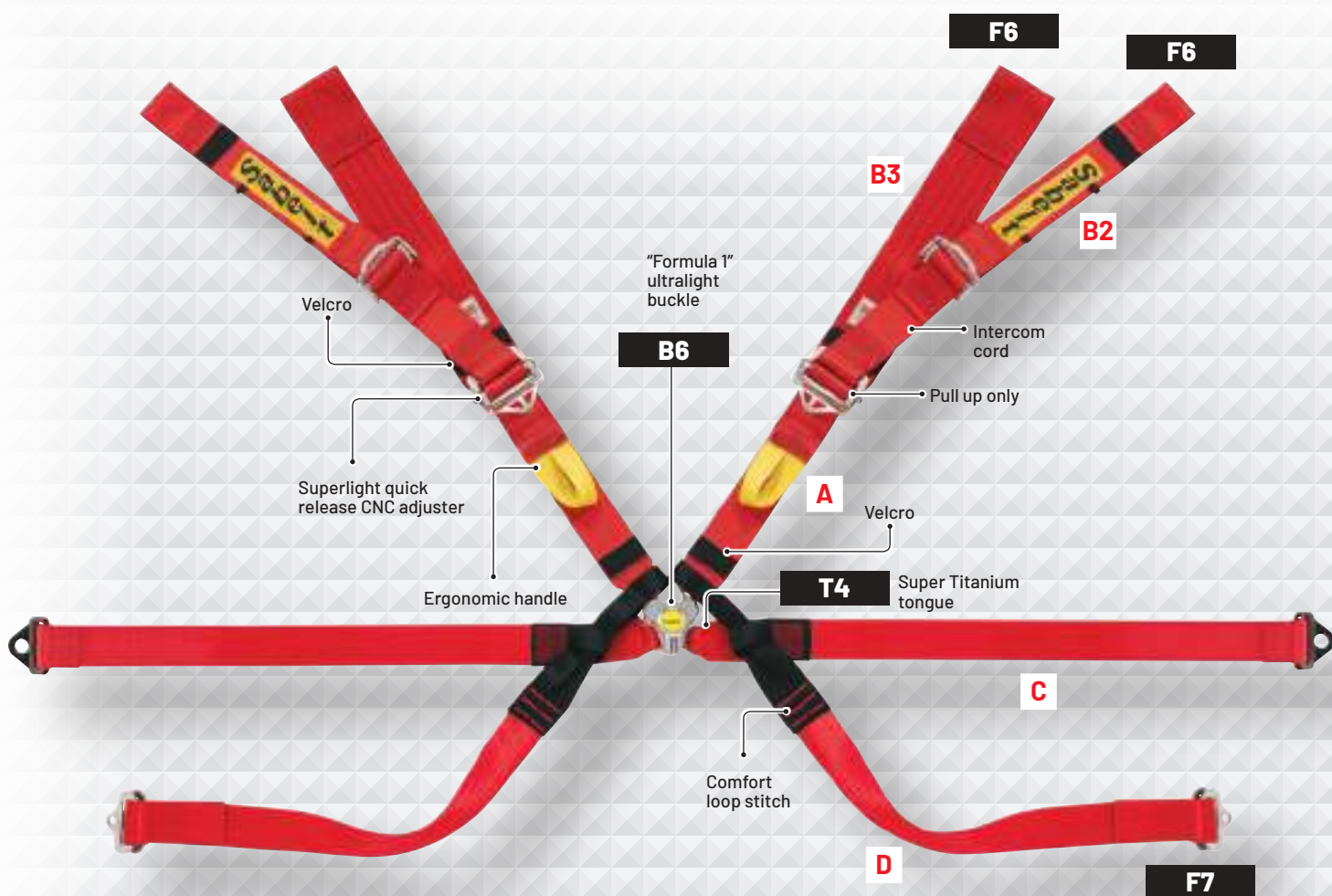



MANUFACTURER: SABELT
 MODEL: NEW SPEC F4
 HOM. NO: SH.061.19-T-8
 FIA STANDARD: 8853-2016

Alpine - Europa Cup Alpine

GOLD Superformula 6p

STANDARD FEATURES

FORMULA				GOLD	FIA 8853-2016		
STANDARD MEASURES (mm)				STANDARD COLOURS/CODES			
A	B	C	D				
360	370	975 FULL Length	960 FULL Length	CFCI4393G622FU6F	CFCI2393G622FU6F	CFCI1393G622FU6F	

CFCI4393G622FU6F

CONFIGURATIONS ON DEMAND (See details at page 19)

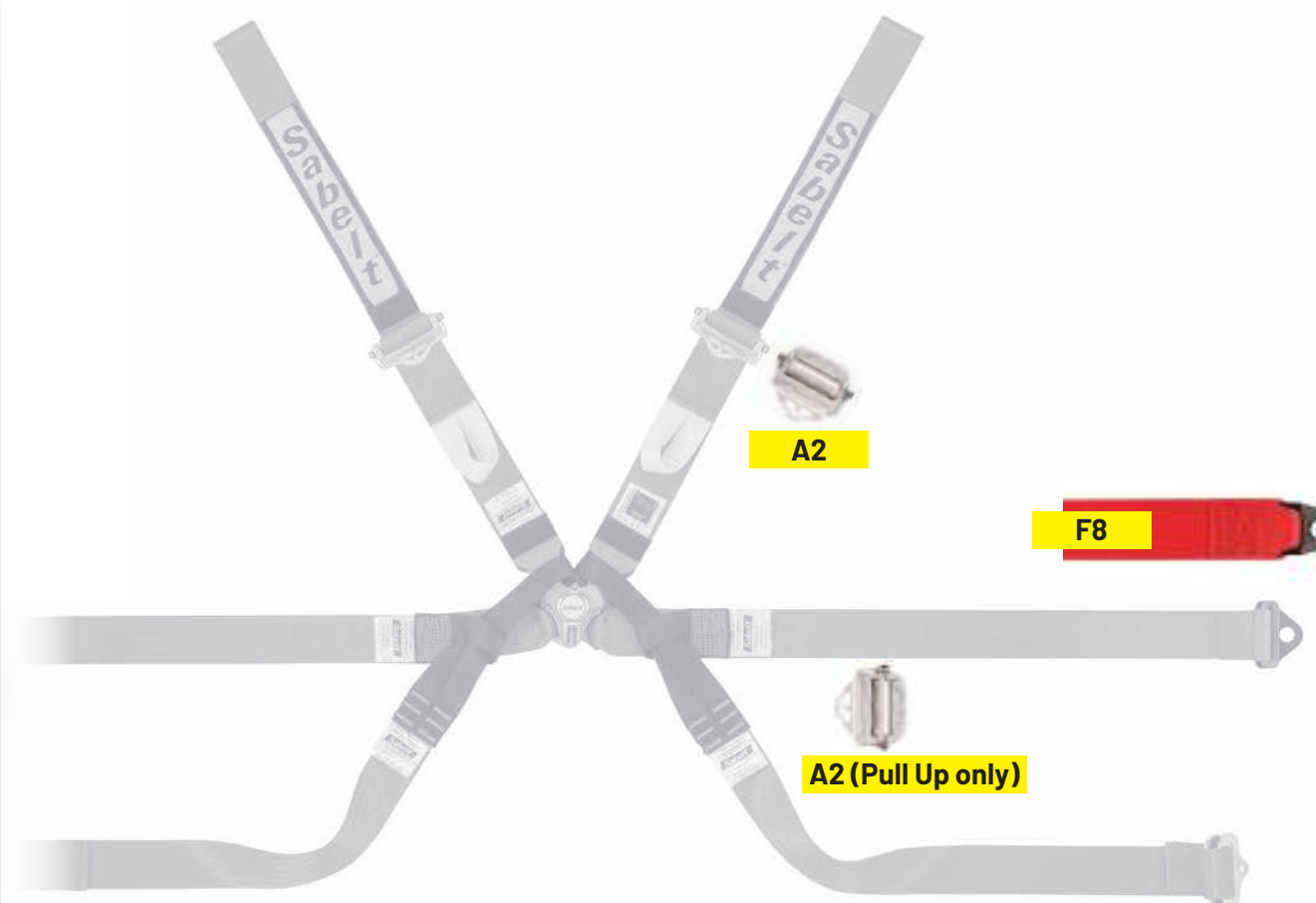
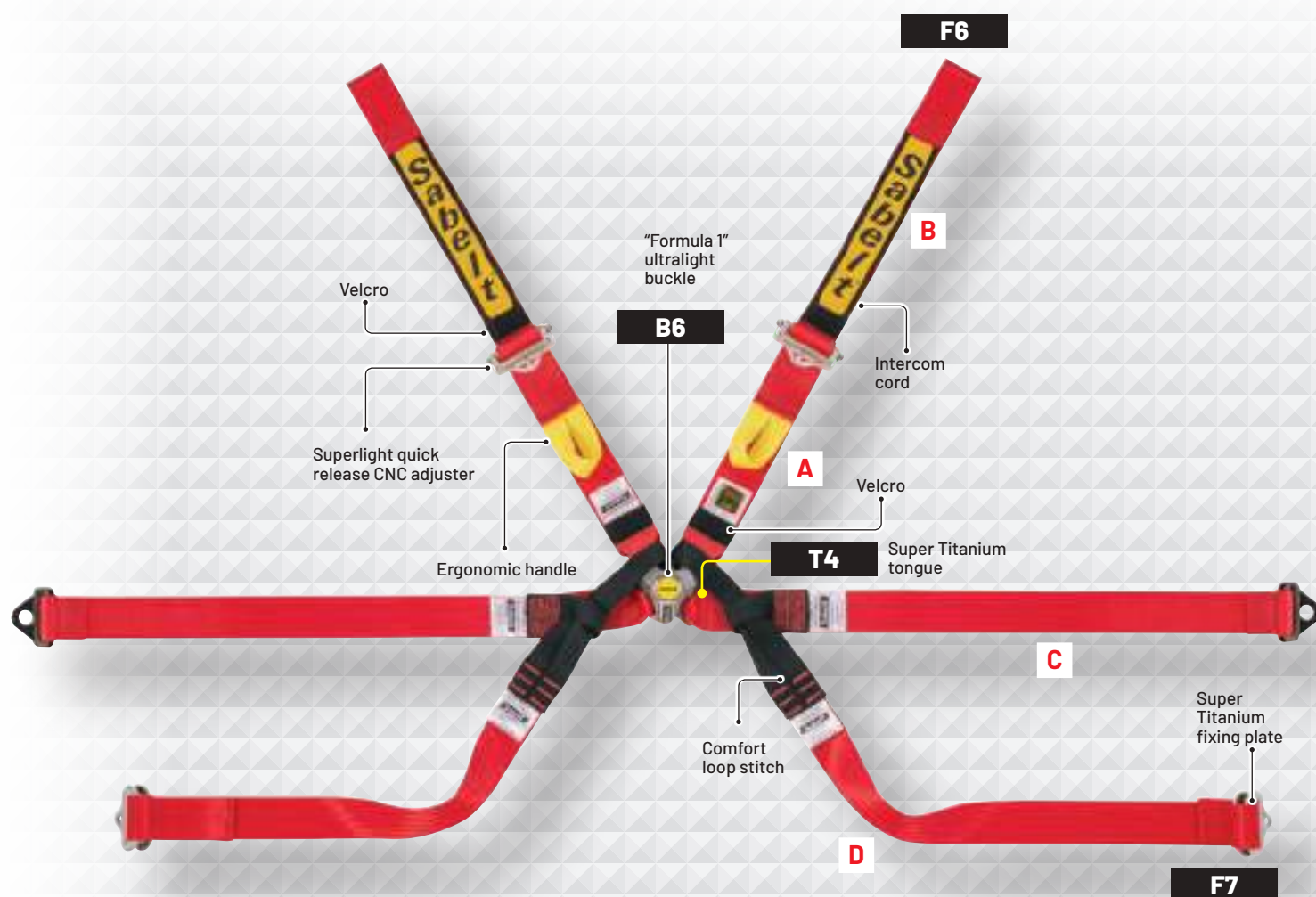
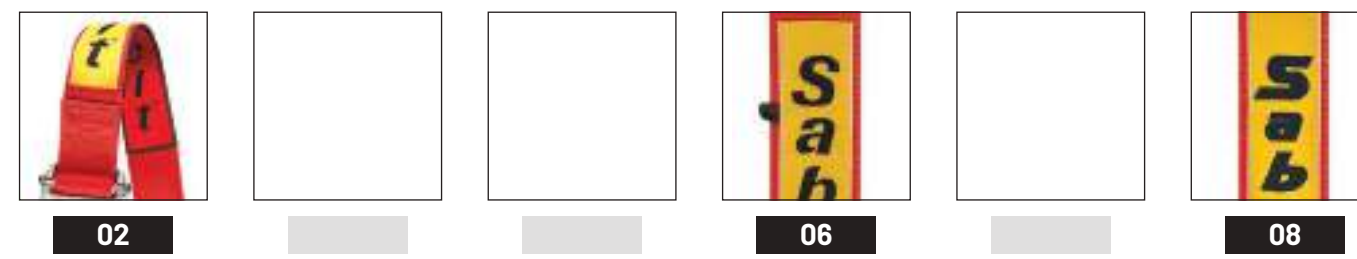

MANUFACTURER: SABELT
 MODEL: NEW SPEC F3
 HOM. NO: SH.047.18-T-6
 FIA STANDARD: 8853-2016

SILVER Formula

STANDARD FEATURES

FORMULA				SILVER	FIA 8853-2016	
STANDARD MEASURES (mm)				STANDARD COLOURS/CODES		
A	B	C	D			
440	700	530+120	1200	CFCI4350A622FU3F6	CFCI2350A622FU3F6	CFCI1350A622FU3F6

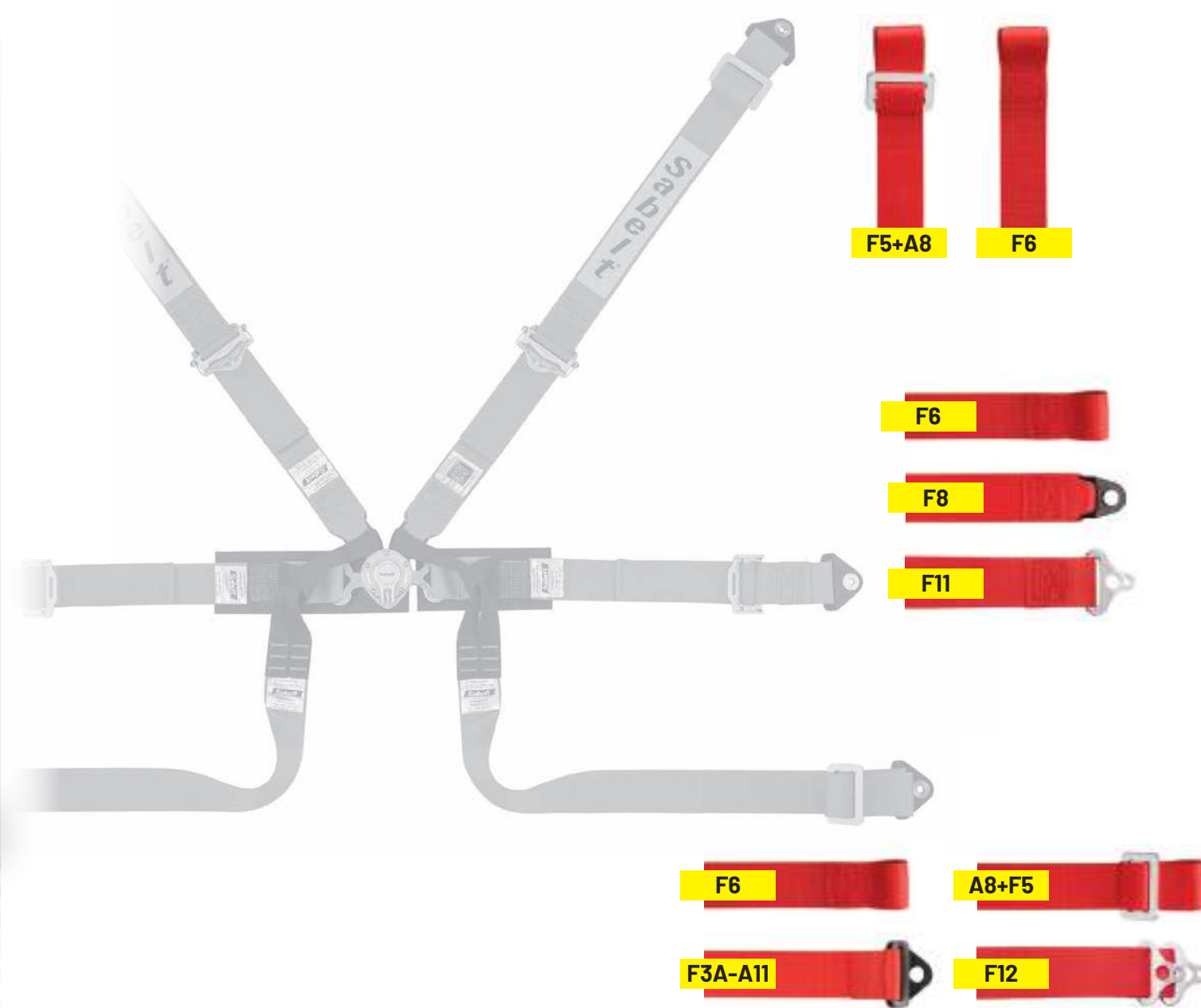
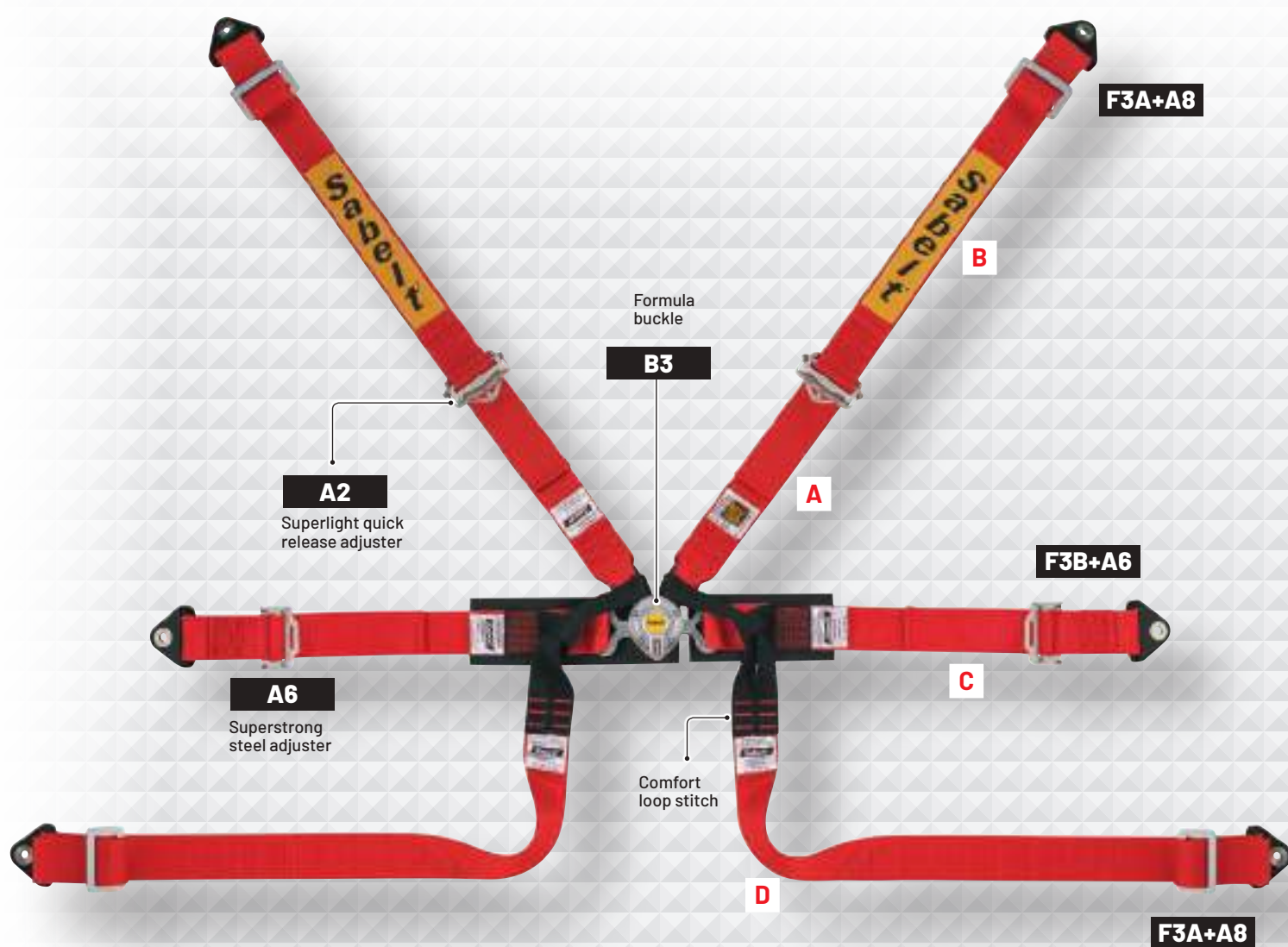
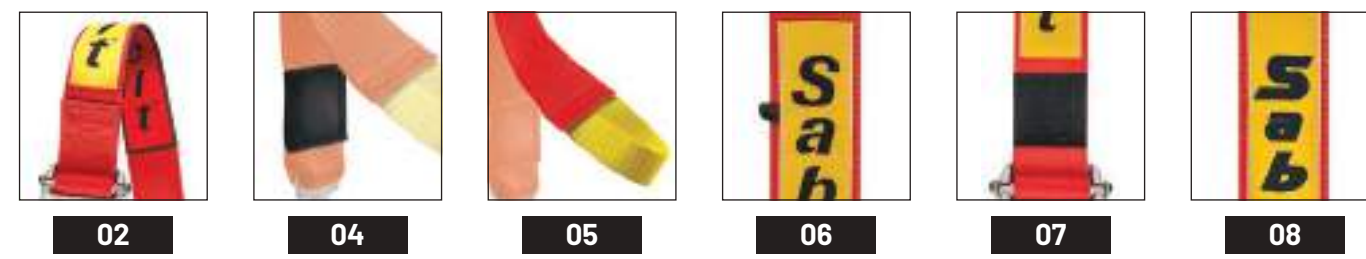

CFCI4350A622FU3F6

CONFIGURATIONS ON DEMAND (See details at page 19)



STEEL Formula basic

STANDARD FEATURES

FORMULA				STEEL	FIA 8853-2016	
STANDARD MEASURES (mm)				STANDARD COLOURS/CODES		
A	B	C	D			
440	700	530+120	1200	CFCI4350S622FU3F6	CFCI2350S622FU3F6	CFCI1350S622FU3F6

CFCI4350S622FU3F6

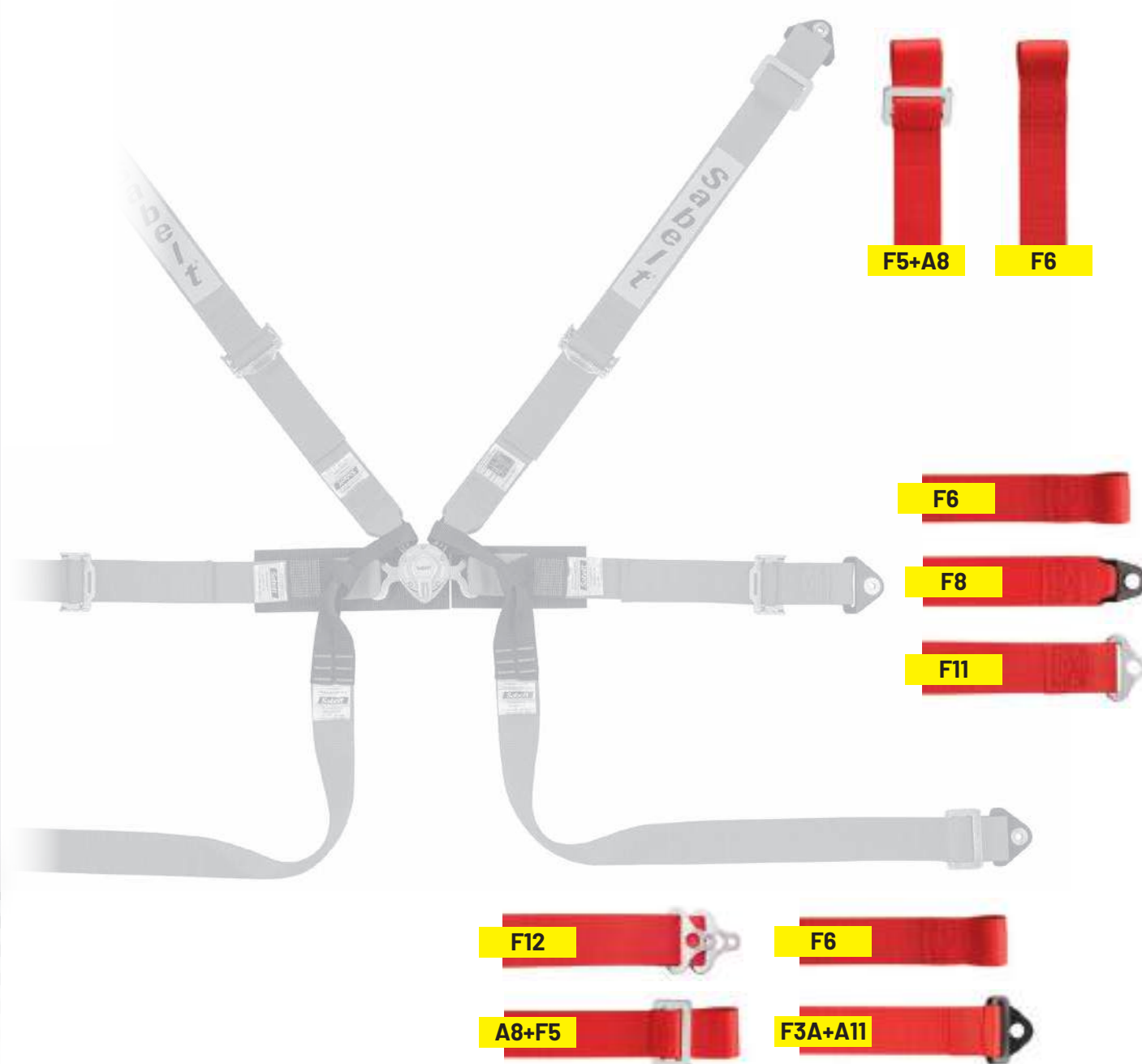
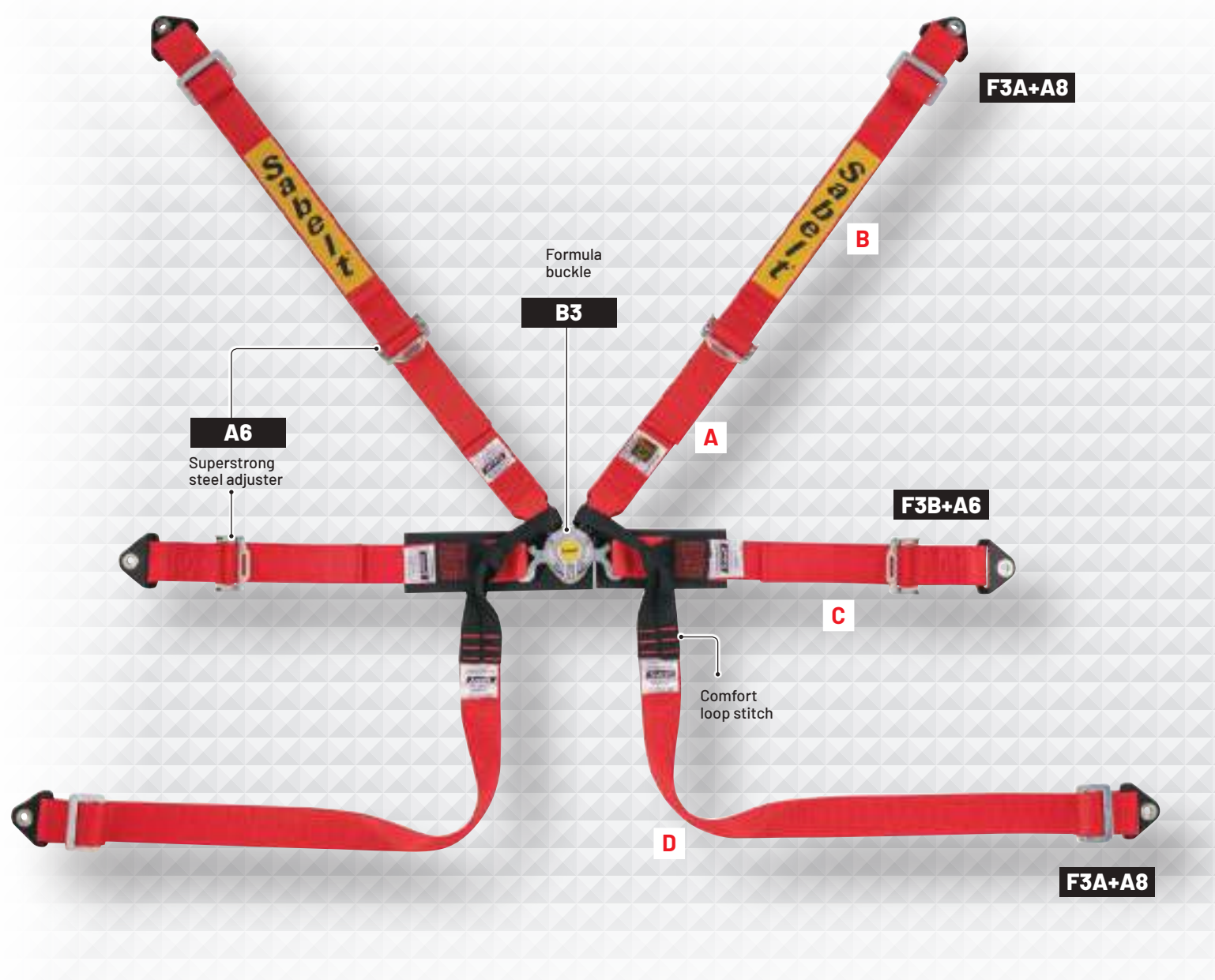
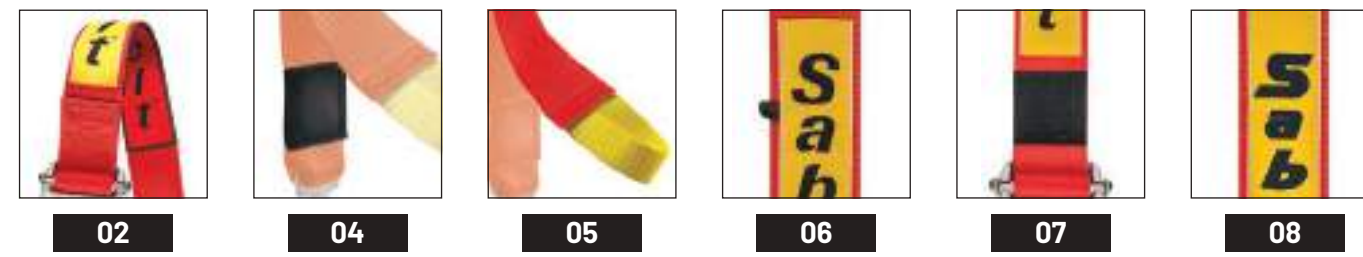

CONFIGURATIONS ON DEMAND (See details at page 19)



STEEL Formula mid

CFCI43500059

STANDARD FEATURES

FORMULA				STEEL	FIA 8853-2016		
STANDARD MEASURES (mm)				STANDARD COLOURS/CODES			
A	B	C	D				
440	320	400+120	950	CFCI43500059	CFCI23500059	CFCI13500059	

CONFIGURATIONS ON DEMAND (See details at page 19)

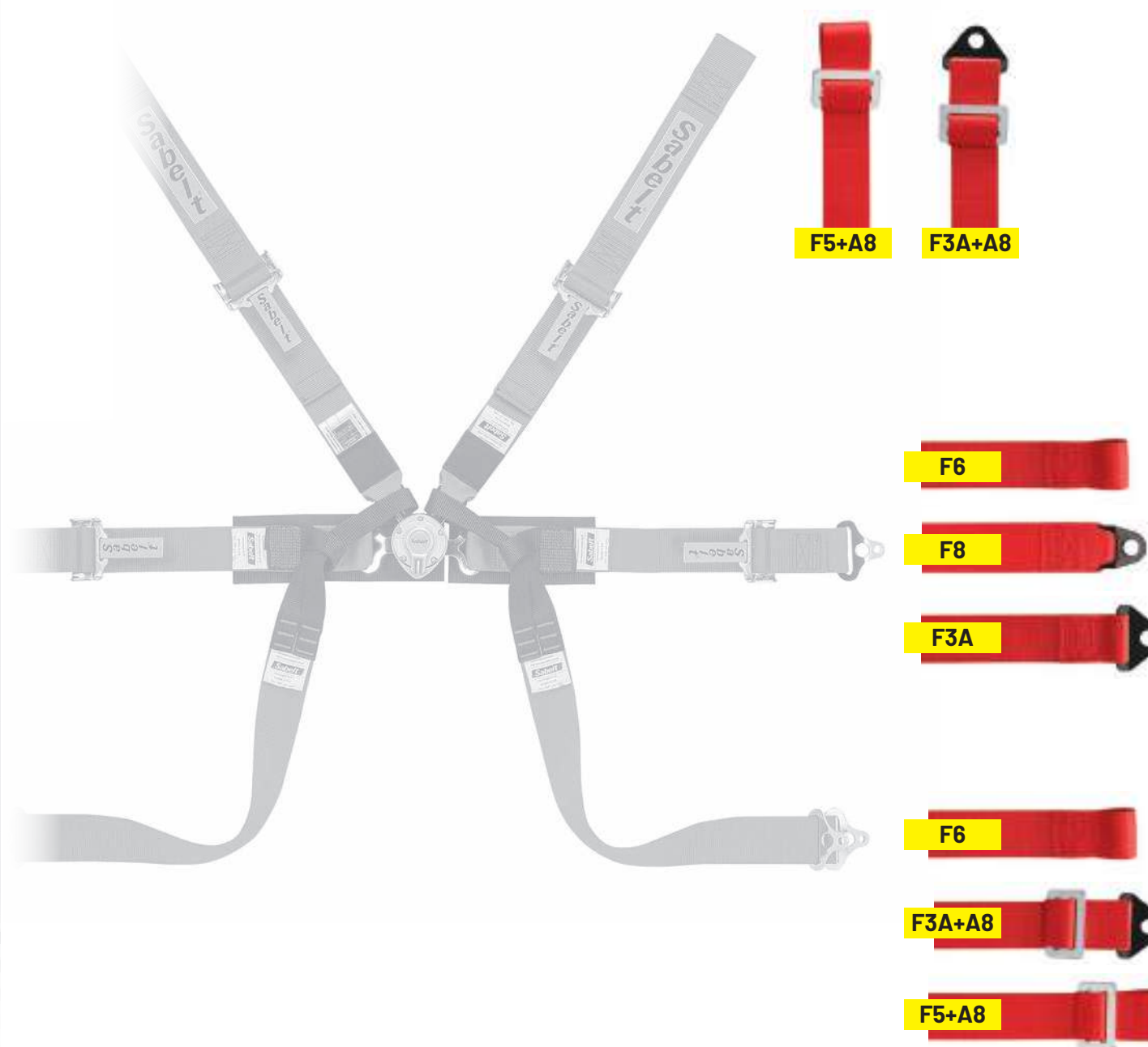
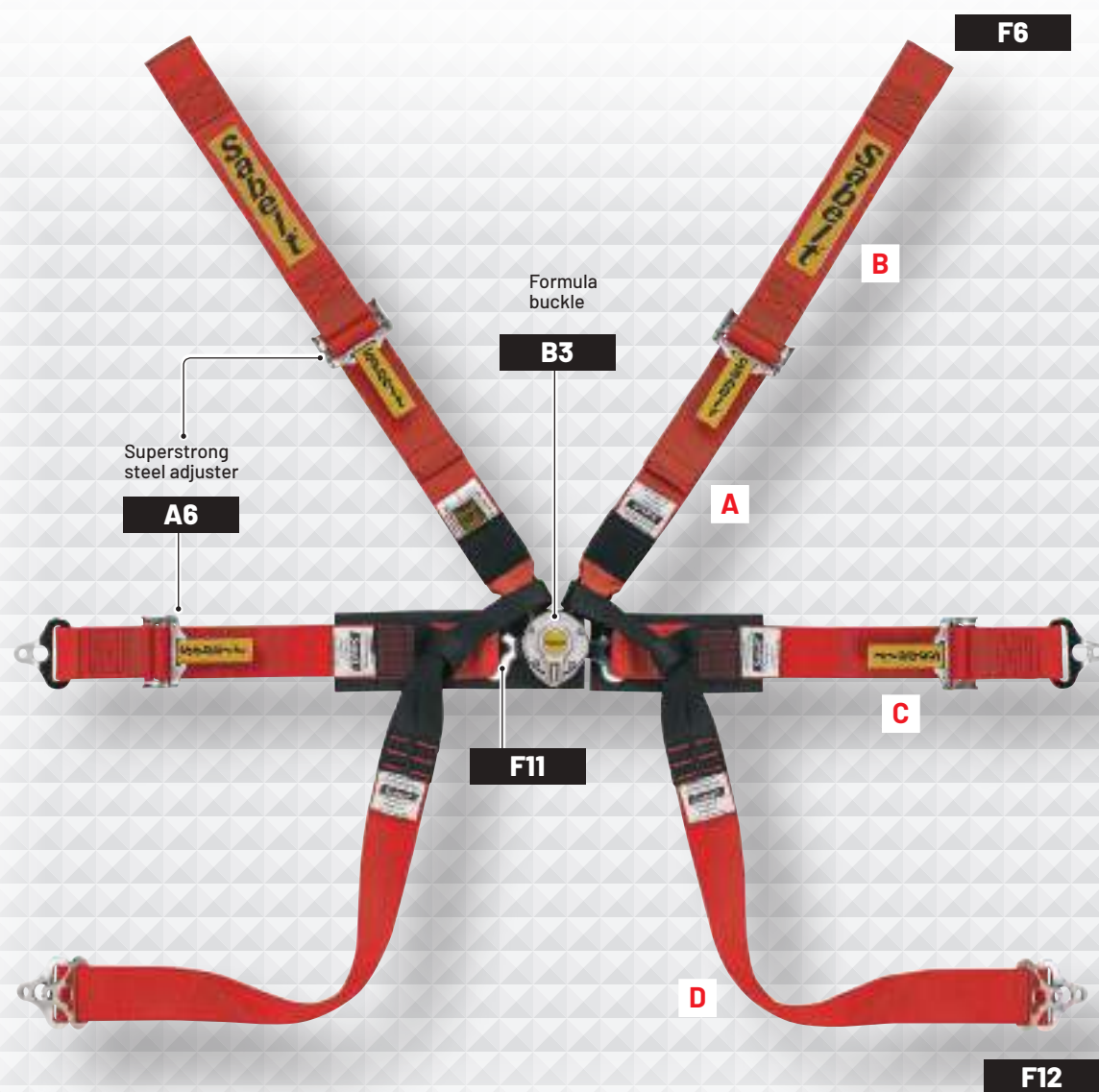
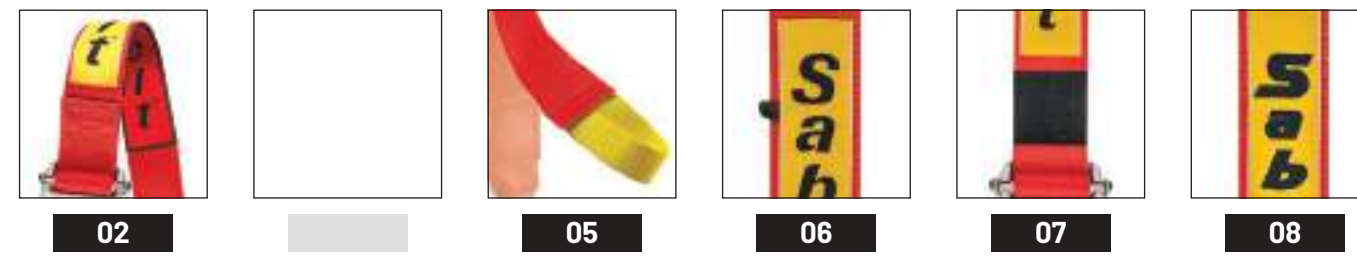

MANUFACTURER: SABELT
 MODEL: NEW SPEC F2
 HOM. NO: SH.033.17-T-6
 FIA STANDARD: 8853-2016



Sierra Cars - Pikes Peak

SILVER 911 passenger

CFCI2000A422SD3F - STANDARD FEATURES

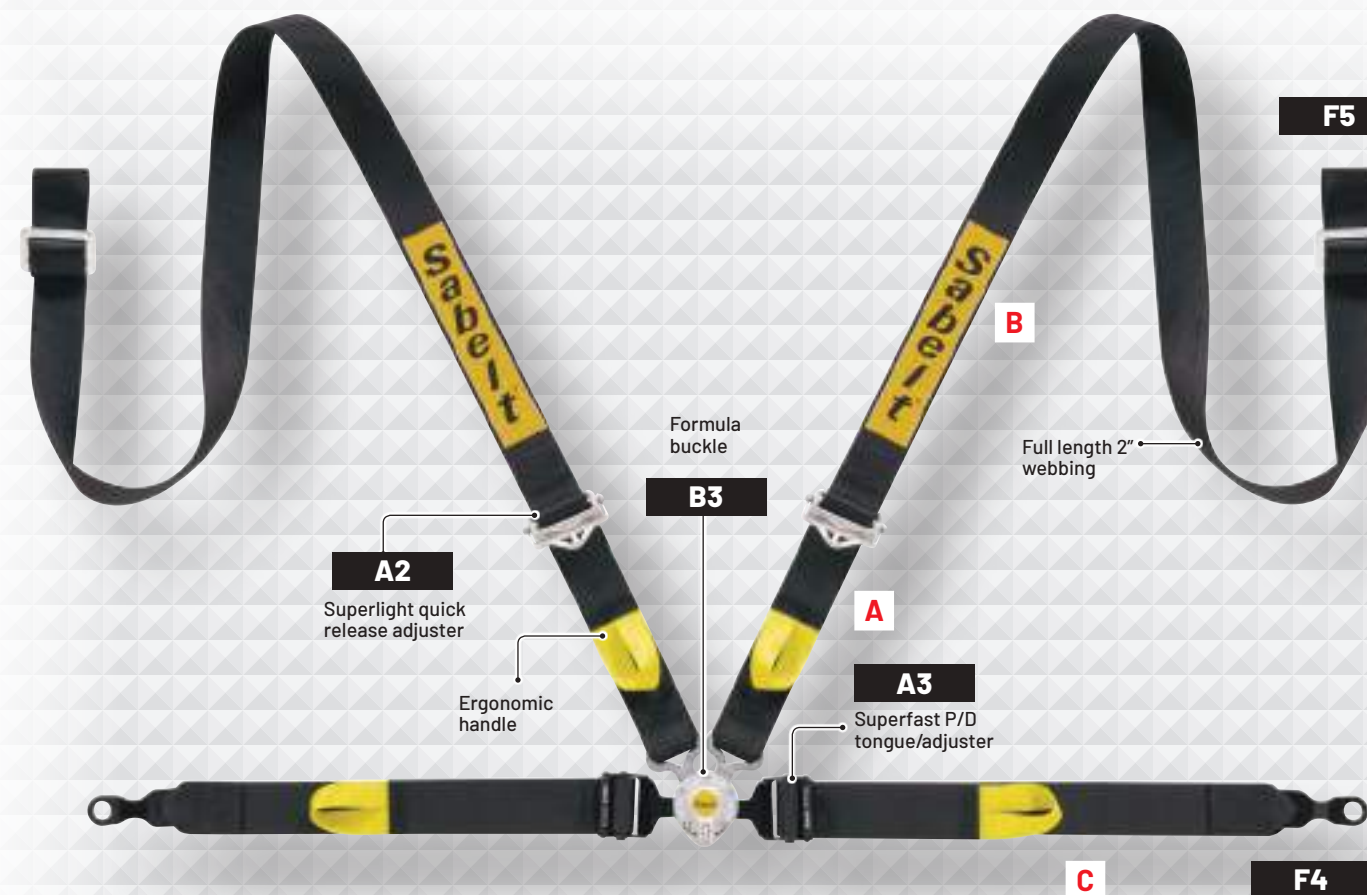

GT / ROAD			SILVER	FIA 8854/98	
STANDARD MEASURES (mm)			STANDARD COLOURS/CODES		
A	B	C			
360	1700	720	CFCI4000A422SD3F	CFCI2000A422SD3F	CFCI1000A422SD3F



NOT HOMOLOGATED

SILVER Kit Car

STANDARD FEATURES

SALOON - FOR KIT CAR "W"				SILVER	FIA 8854/98		
STANDARD MEASURES (mm)				STANDARD COLOURS/CODES			
A	B	C					
480	450	130+610		CFCI4118A433SD4F	CFCI2118A433SD4F	CFCI1118A433SD4F	

CFCI4118A433SD4F

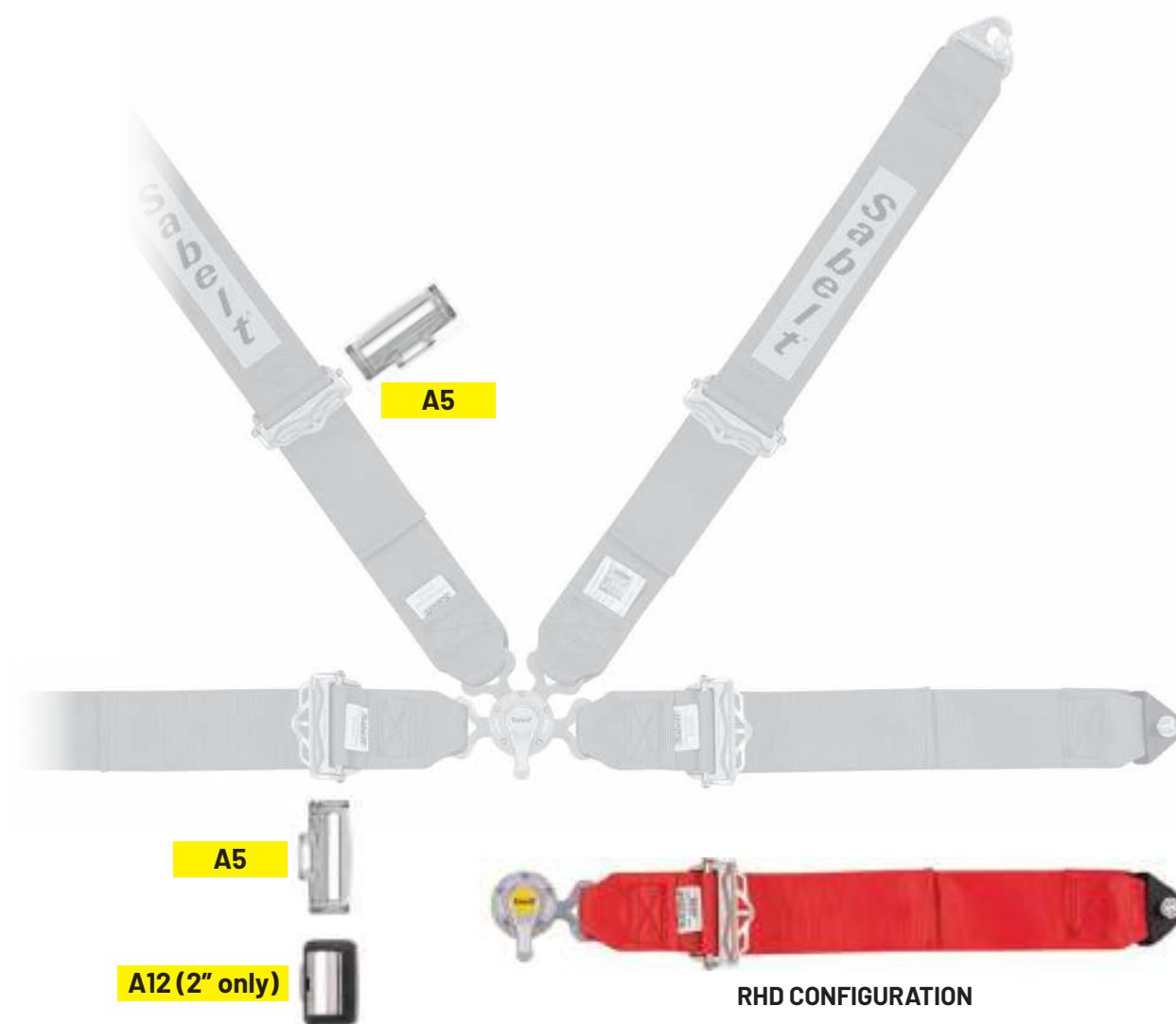
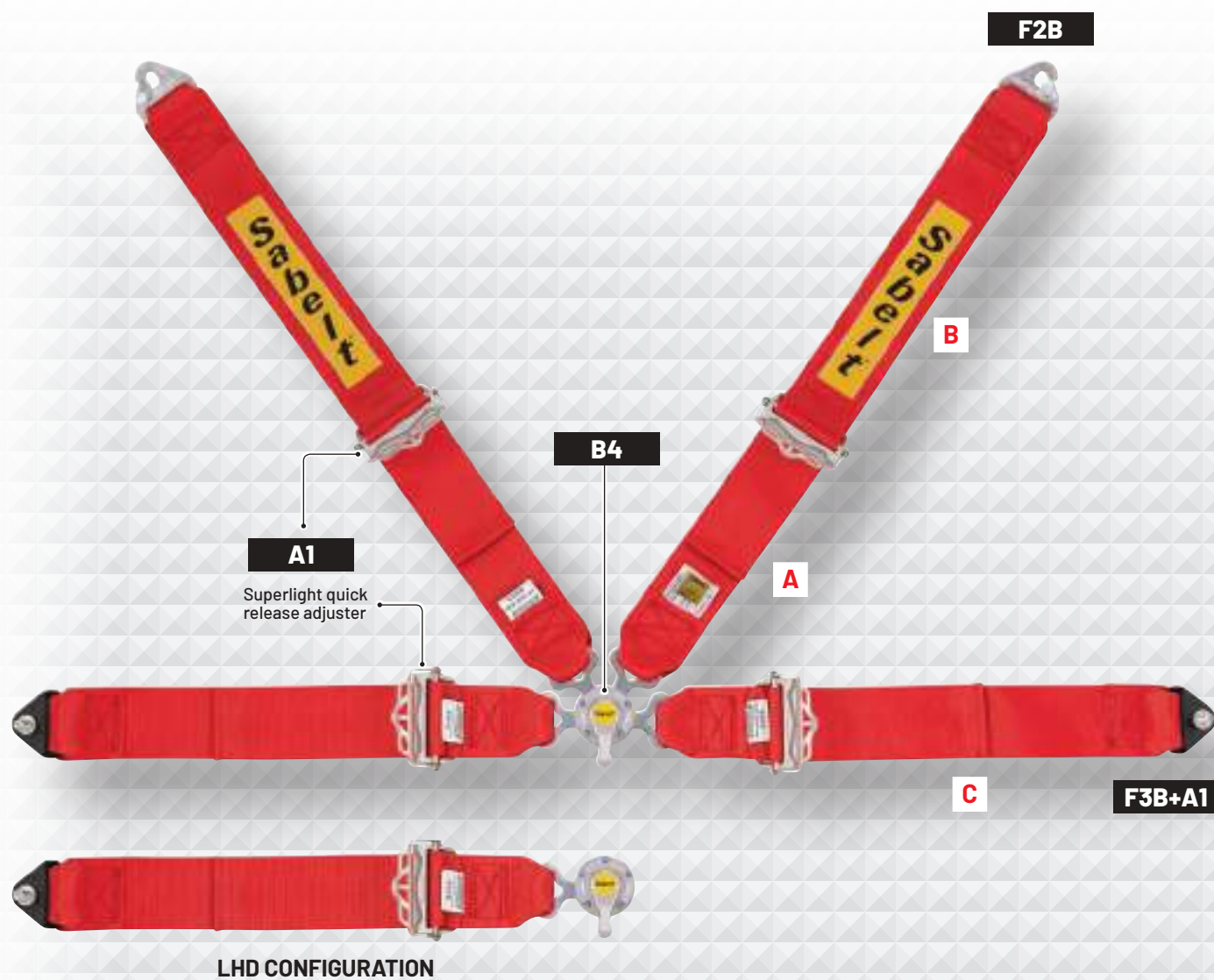
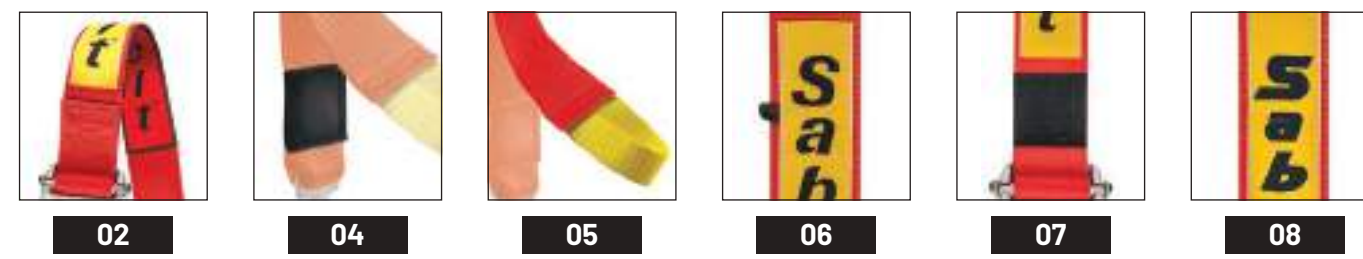

CONFIGURATIONS ON DEMAND (See details at page 19)



MANUFACTURER: SABELT
 MODEL: TOP FORMULA
 HOM. NO: B.122.T/98
 FIA STANDARD: 8854/98

STEEL Kit Car

STANDARD FEATURES

SALOON - FOR KIT CAR "C"				STEEL	FIA 8854/98	
STANDARD MEASURES (mm)				STANDARD COLOURS/CODES		
A	B	C				
480	450	130+610		CFCI4118S433SD4F	CFCI2118S433SD4F	CFCI1118S433SD4F

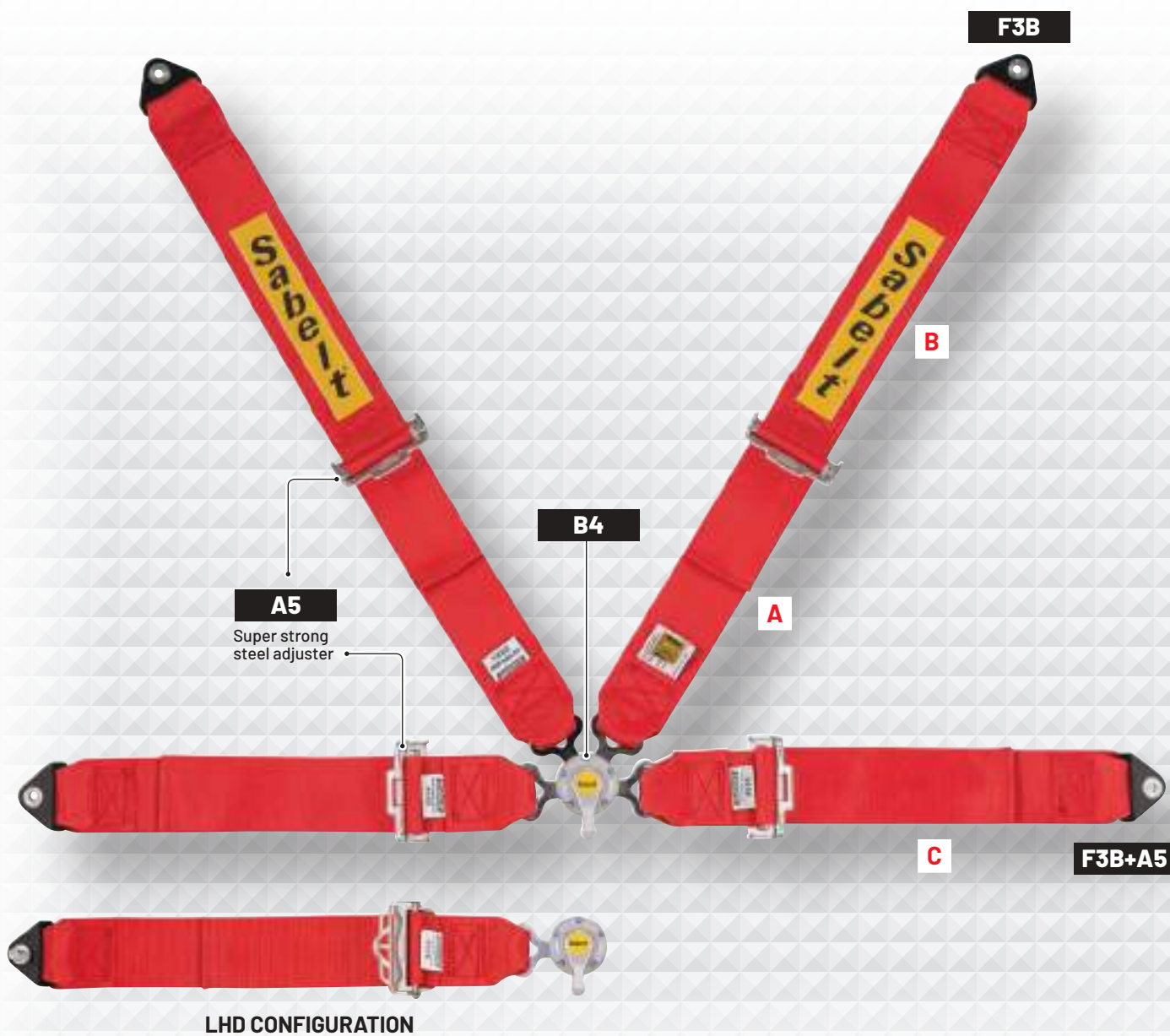

CFCI4118S433SD4F

CONFIGURATIONS ON DEMAND (See details at page 19)

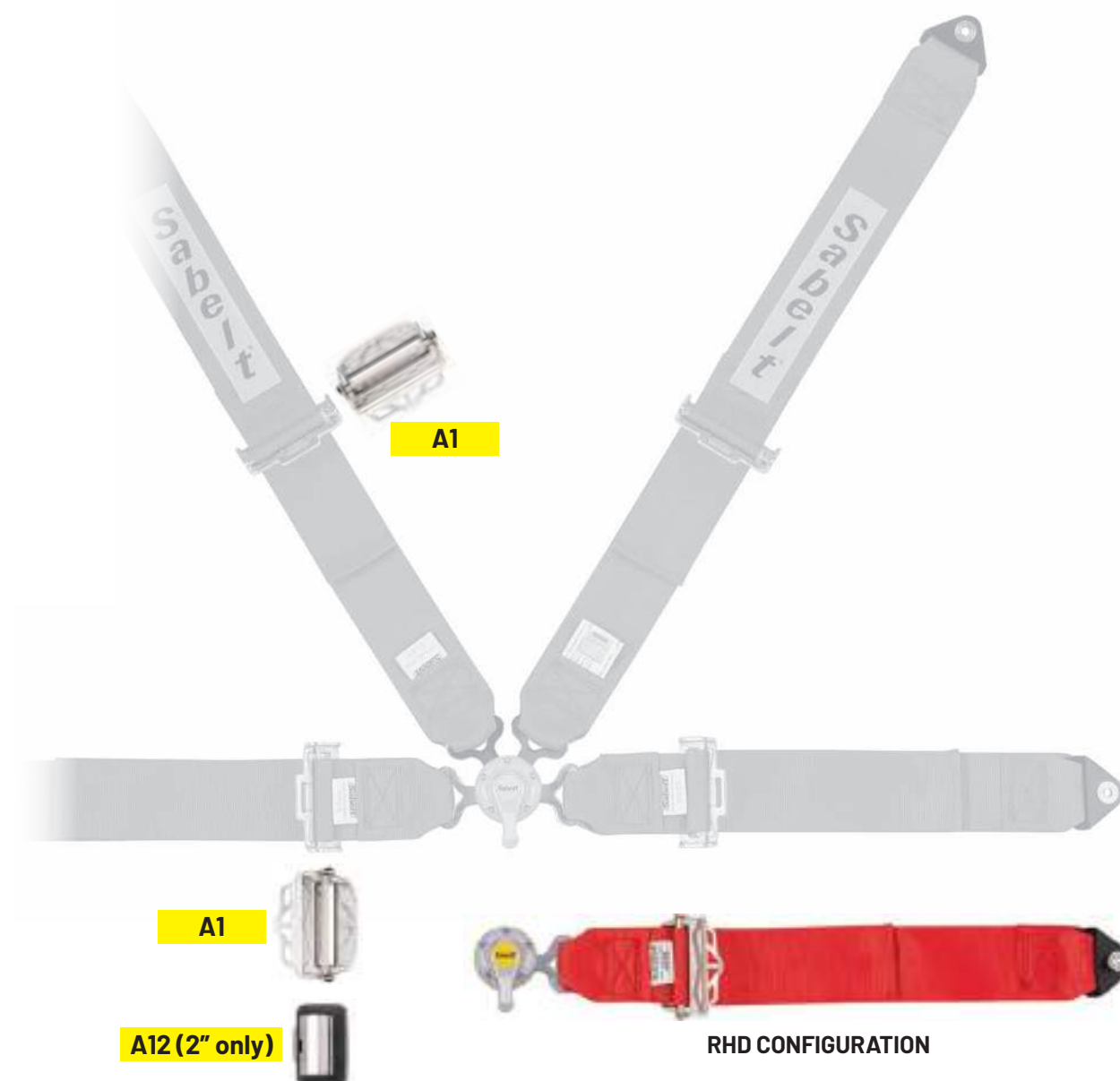
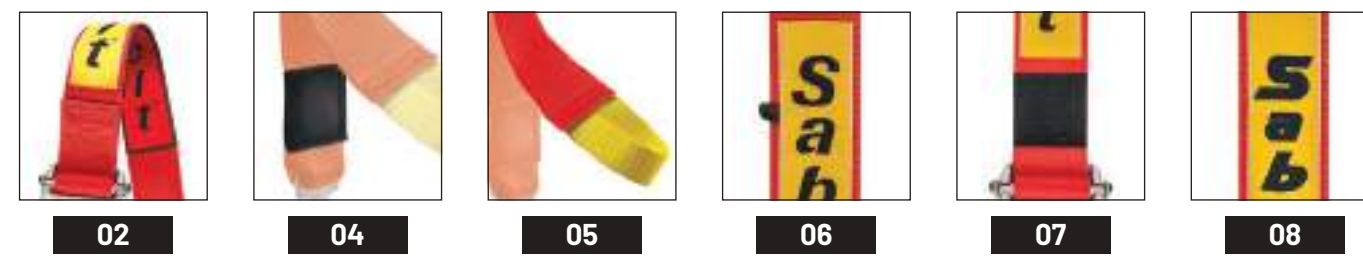

STEEL Four Point

CFCI4118S433SU4F - STANDARD FEATURES

SALOON				STEEL	FIA 8854/98		
STANDARD MEASURES (mm)				STANDARD COLOURS/CODES			
A	B	C					
380	1700	560+120		CFCI4118S433SU4F	CFCI2118S433SU4F	CFCI118S433SU4F	

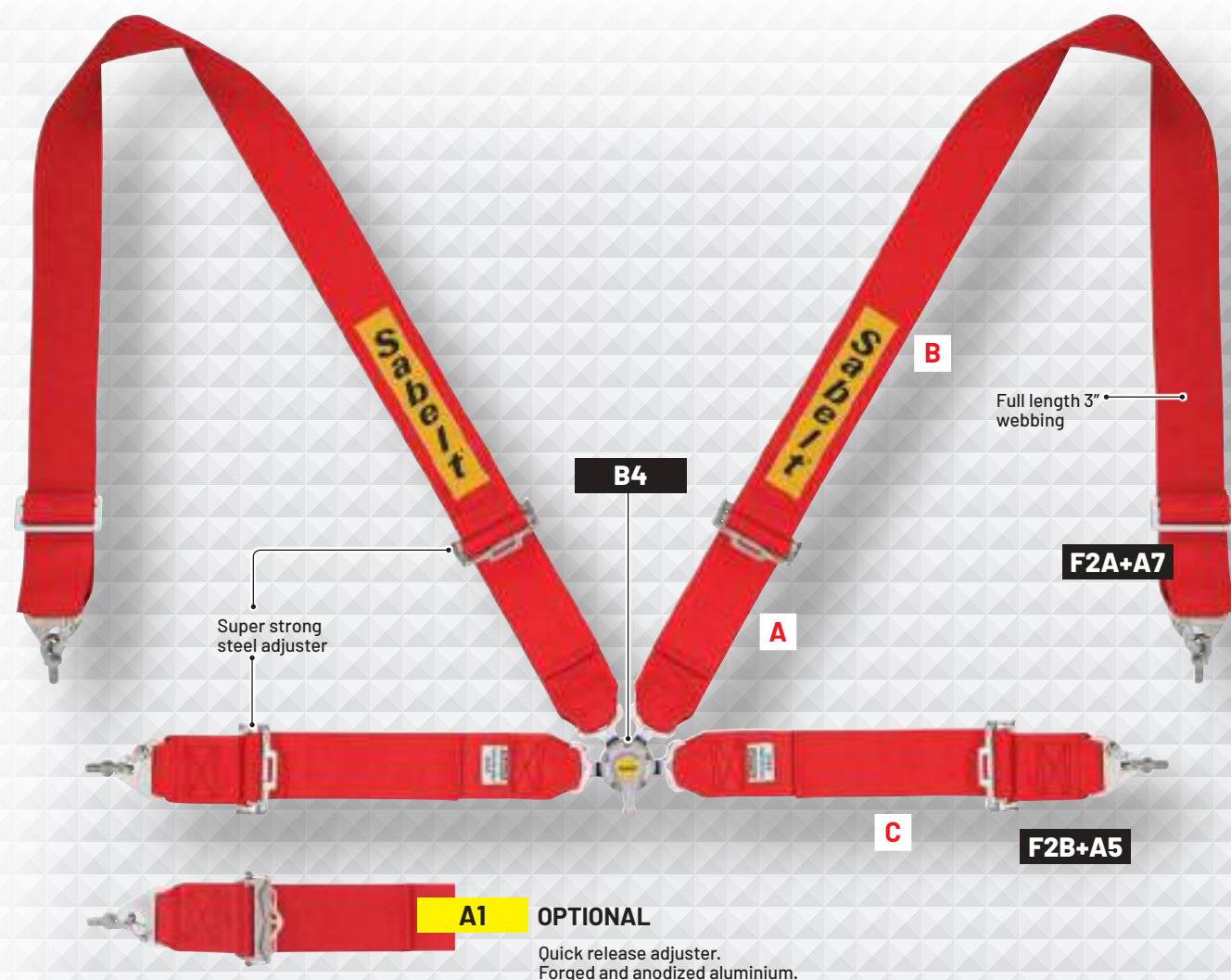

EYE BOLTS AND PLATES



407005_C
Standard eye-bolt diam. 7/16" UNF thread length 23 mm, 25 mm tot., 8.8.



CCM10023
Eye-bolt metric M10 x 1.5 thread length 23 mm, 8.8. Does not comply with FIA requirements.



CCM10017_A WESTFIELD
Eye-bolt 50 mm. long, 7/16", 8.8



CCM10016
Eye-bolt back plate 65 mm x 65 mm x 3 mm 7/16" UNF thread welded nut, 40 mm². Complies with FIA requirements.



CCM10135_KIT
Kit with screw 7/16" thread, 35mm length with spacer and washers.

PADS



Vep fabric shoulder cover. 75 mm (3") width. Velcro fastening.

475040	475020	475010



Vep fabric shoulder cover. 50 mm (2") width. Velcro fastening.

450040/S	450020/S	450010/S

COLORED GADGET KIT FOR ENDURANCE BUCKLES B1 TYPE





CCAC0104_KIT
Straps.



CCET0408_KIT
Stickers.





CFCC4046**SALOON**

FIXING POINTS	4
HOMOLOGATION	NOT HOMOLOGATED
STANDARD COLOURS/CODES	
	CFCC4046
	CFCC2046
	CFCC1046



Available on demand buckle with switch for SBR sensor

**CFCC904001NP_A****SALOON**

FIXING POINTS	4
HOMOLOGATION	ECE
Homologation updated to series 08	
STANDARD COLOURS/CODES	
	CFCC904001NP_A
	CFCC902001NP_A
	CFCC901001NP_A



Available on demand buckle with switch for SBR sensor

**CFCC904070NP_B****SALOON**

FIXING POINTS	4
HOMOLOGATION	ECE
Homologation updated to series 08	
STANDARD COLOURS/CODES	
	CFCC904070NP_B
	CFCC902070NP_B
	CFCC901070NP_B



Available on demand buckle with switch for SBR sensor

**CFCC904059NP_B****SALOON**

FIXING POINTS	3
HOMOLOGATION	ECE
Homologation updated to series 08	
STANDARD COLOURS/CODES	
	CFCC904059NP_B
	CFCC902059NP_B
	CFCC901059NP_B



Available on demand buckle with switch for SBR sensor

**CFCC904005N_B****SALOON**

FIXING POINTS	3
HOMOLOGATION	ECE
Homologation updated to series 08	
STANDARD COLOURS/CODES	
	CFCC904005N_B
	CFCC902005N_B
	CFCC901005N_B

Available on demand buckle with switch for SBR sensor

**CFCC904002NP_A****SALOON**



FIXING POINTS	3
HOMOLOGATION	ECE
Homologation updated to series 08	
STANDARD COLOURS/CODES	
	CFCC904002NP_A
	CFCC902002NP_A
	CFCC901002NP_A

Available on demand buckle with switch for SBR sensor



SFI 16.1 STEEL saloon

STANDARD FEATURES

				STEEL	SFI 16.1	
STANDARD MEASURES (MM)				STANDARD COLOURS/CODES		
A	B	C	D			
440	1700	560+120	1080	CFCI4556S622SU2S	CFCI2556S622SU2S	CFCI1556S622SU2S

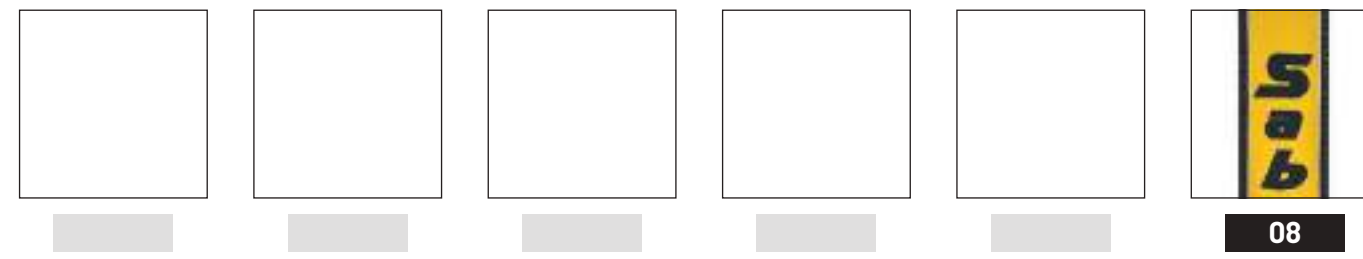

CFCI2556S622SU2S

CONFIGURATIONS ON DEMAND (See details at page 19)



SFI 16.1 STEEL Latch&Link

STANDARD FEATURES

				STEEL	SFI 16.1	
STANDARD MEASURES (mm)				STANDARD COLOURS/CODES		
A	B	C	D			
380	1700	680	770	CFCI4000S533SD8S	CFCI2000S533SD8S	CFCI1000S533SD8S

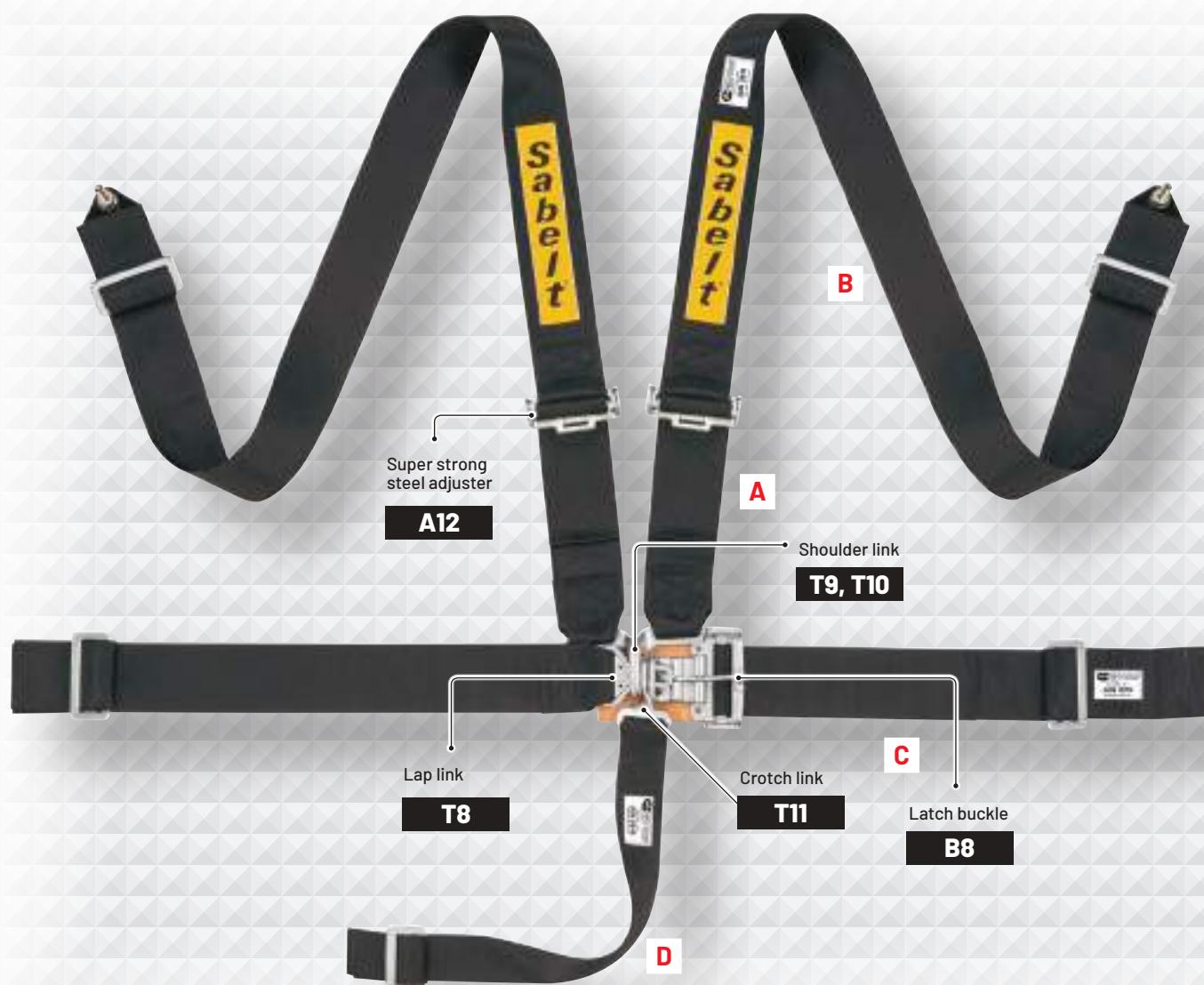

CFCI2000S533SD8S

CONFIGURATIONS ON DEMAND (See details at page 19)

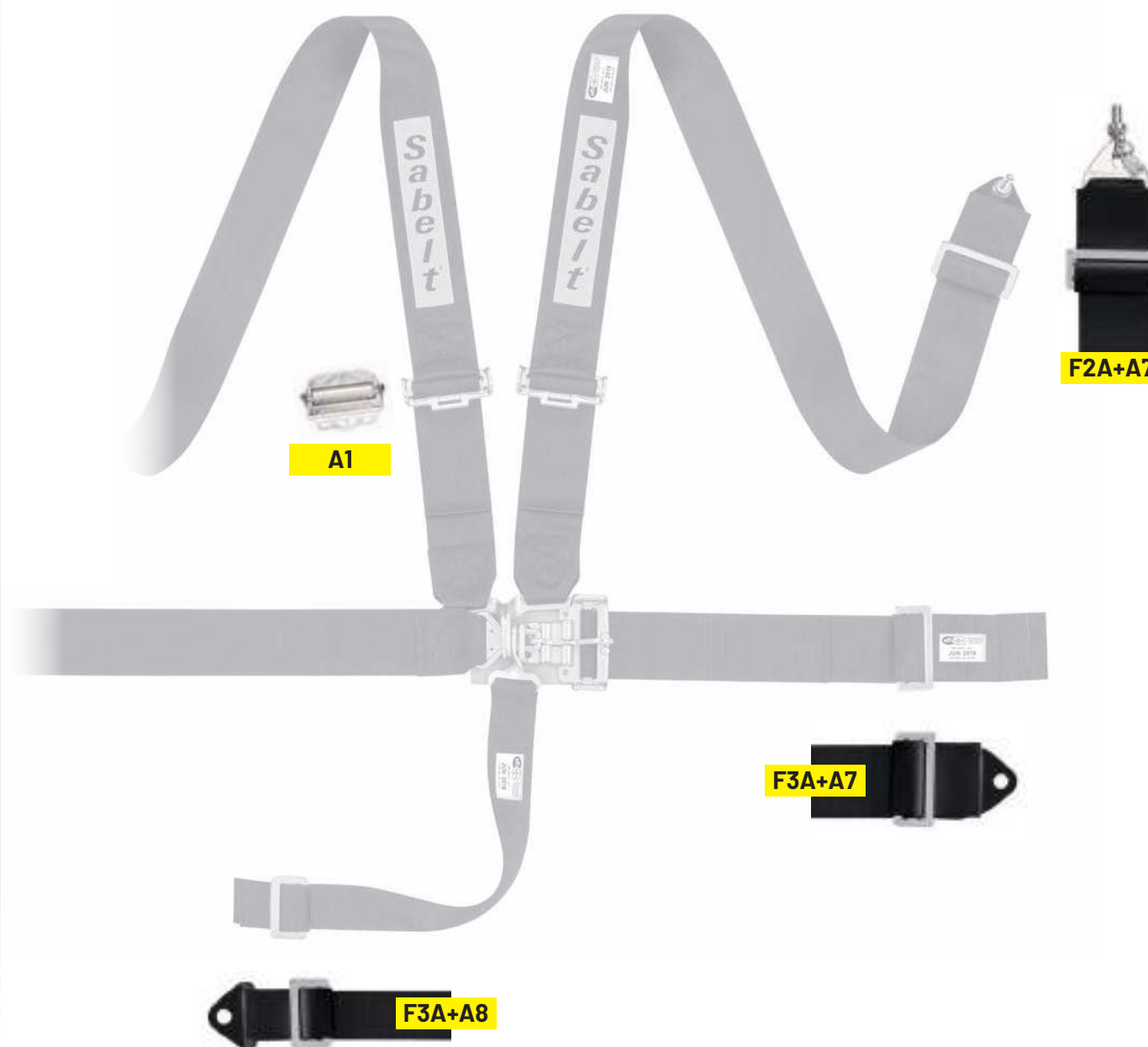
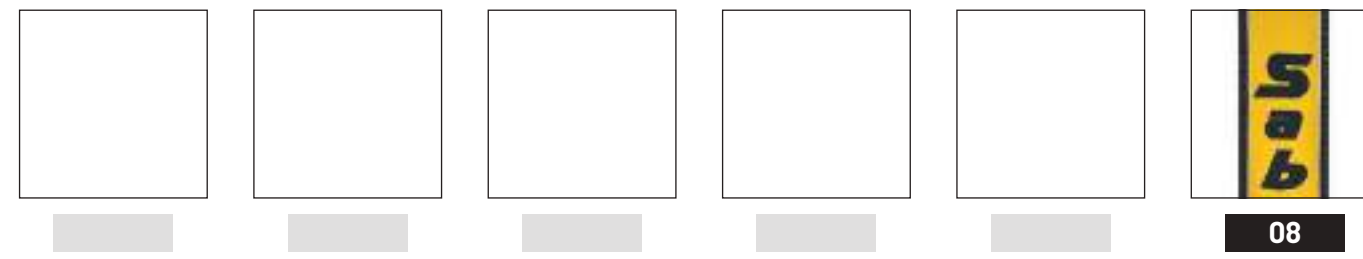

NETS



Cupra - ETCR

CFRN2010 (GT-3 Door side)

RACING NET - DEVELOPED WITH FERRARI COMPETIZIONI GT

FIA APPROVED
 MANUFACTURER: SABELT
 MODEL: CFRN2010
 HOM. NO: RN.028.22
 FIA STANDARD: 8863-2013

This configuration is homologated for F296. Specifically developed for Ferrari F171 seat.

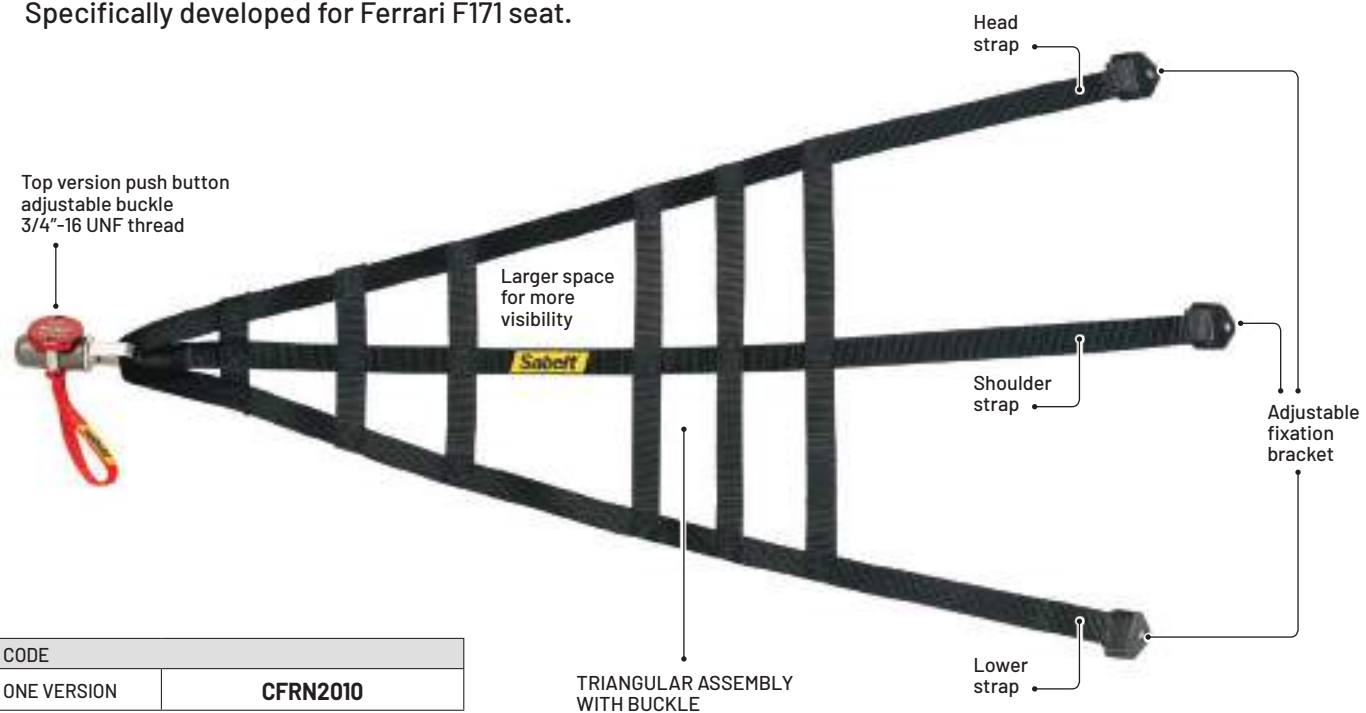

CFRN2012 (GT-3 Tunnel side)

RACING NET - DEVELOPED WITH FERRARI COMPETIZIONI GT

FIA APPROVED
 MANUFACTURER: SABELT
 MODEL: CFRN2012
 HOM. NO: RN.029.22
 FIA STANDARD: 8863-2013

This configuration is homologated for F296. Specifically developed for Ferrari F171 seat.

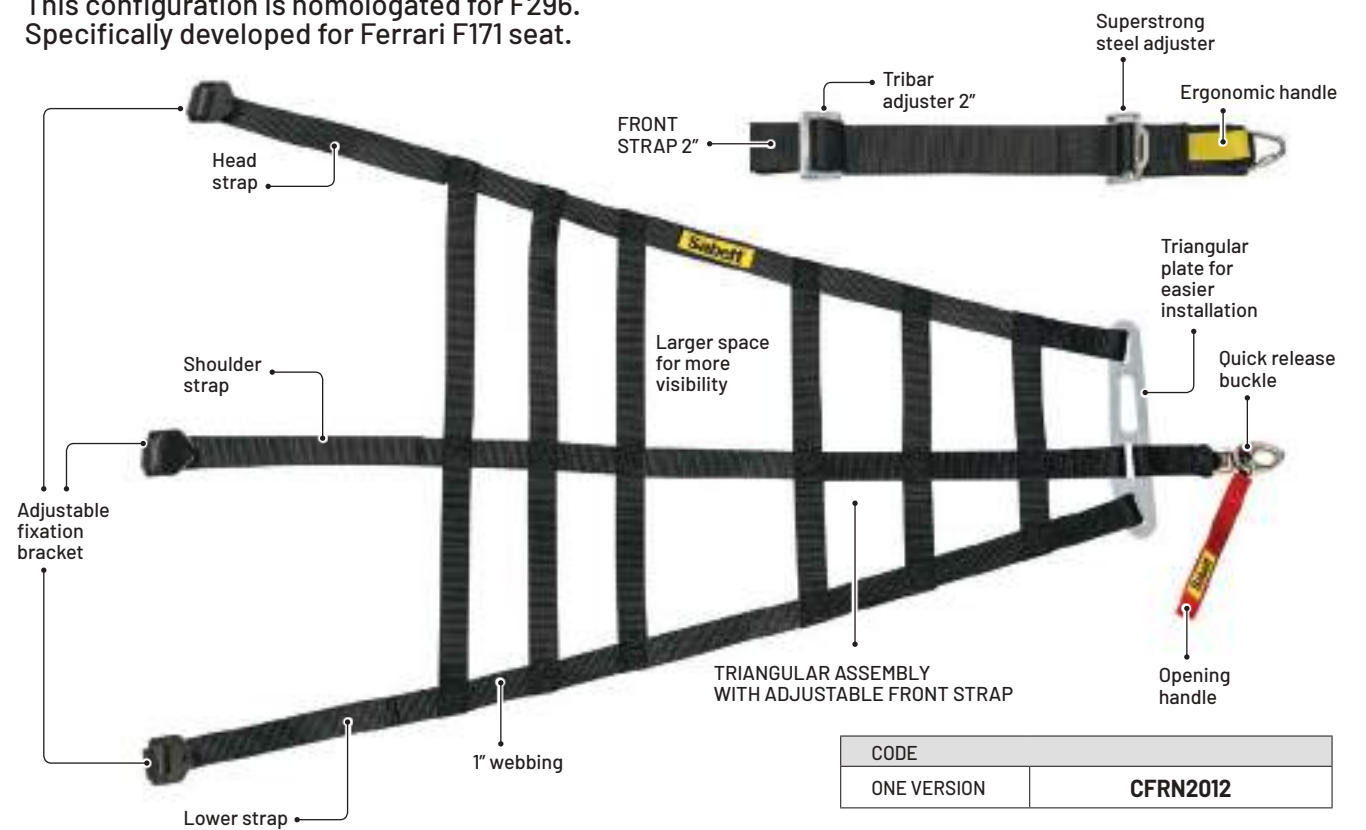

CFRN2008 (Universal Gold)

RACING NET

FIA APPROVED
 MANUFACTURER: SABELT
 MODEL: CFRN2008
 HOM. NO: RN.025.21
 FIA STANDARD: 8863-2013

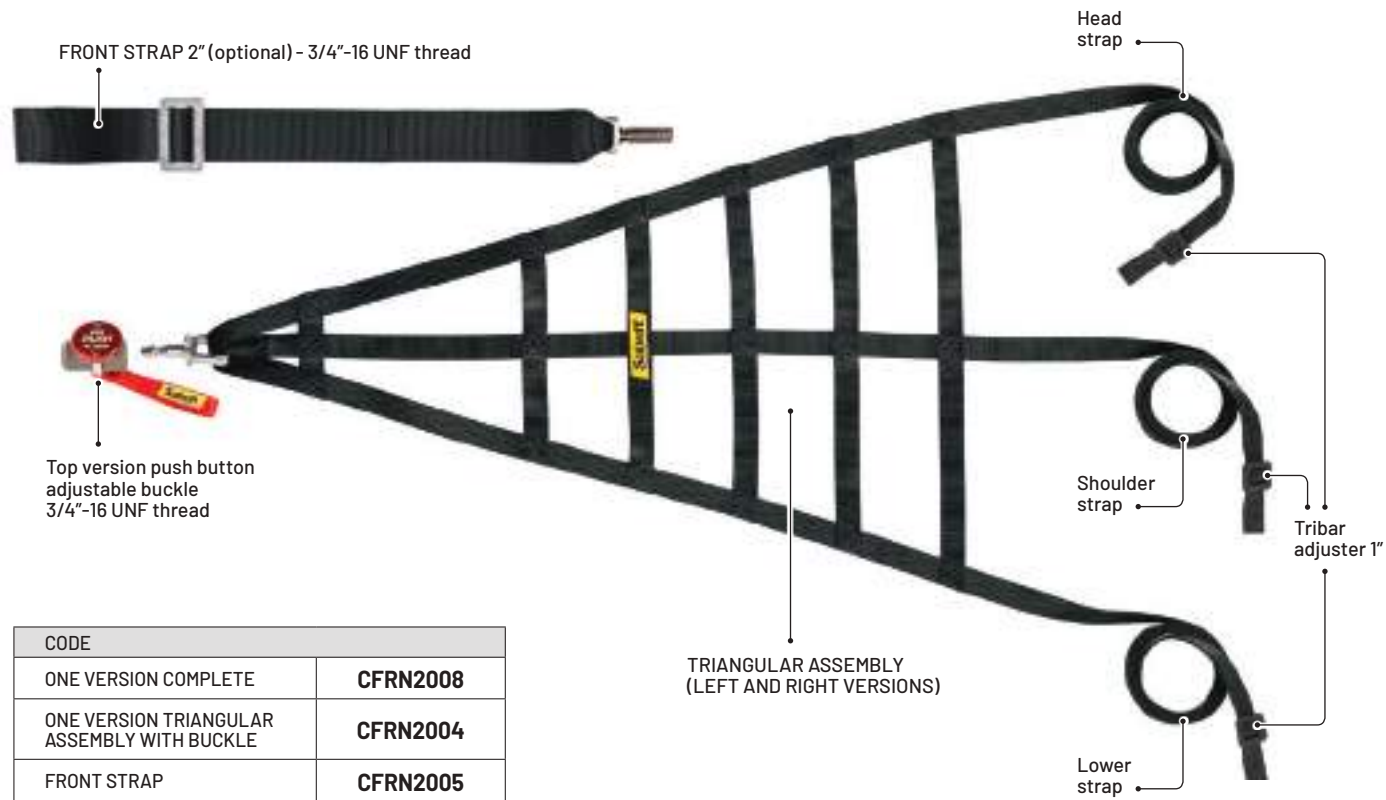

CODE	
ONE VERSION COMPLETE	CFRN2008
ONE VERSION TRIANGULAR ASSEMBLY WITH BUCKLE	CFRN2004
FRONT STRAP	CFRN2005

CFRN2027 (New Universal Steel)

RACING NET

NEW

FIA APPROVED
 MANUFACTURER: SABELT
 MODEL: CFRN2015
 HOM. NO: RN.020.20
 FIA STANDARD: 8863-2013

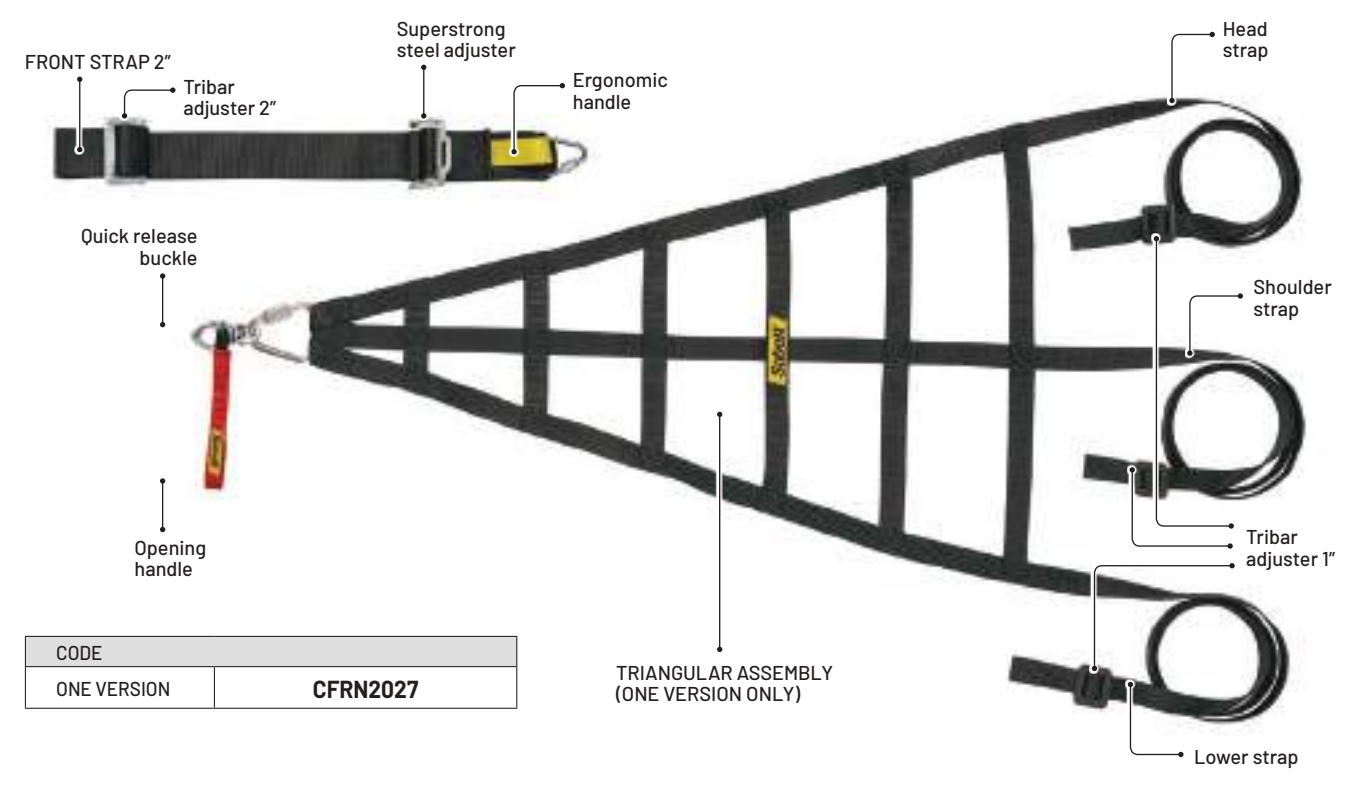

CODE	
ONE VERSION	CFRN2027

CFRN2003 (Universal Tunnel side)

RACING NET

FIA APPROVED
 MANUFACTURER: SABELT
 MODEL: CFRN2003
 HOM. NO: RN.015.18
 FIA STANDARD: 8863-2013

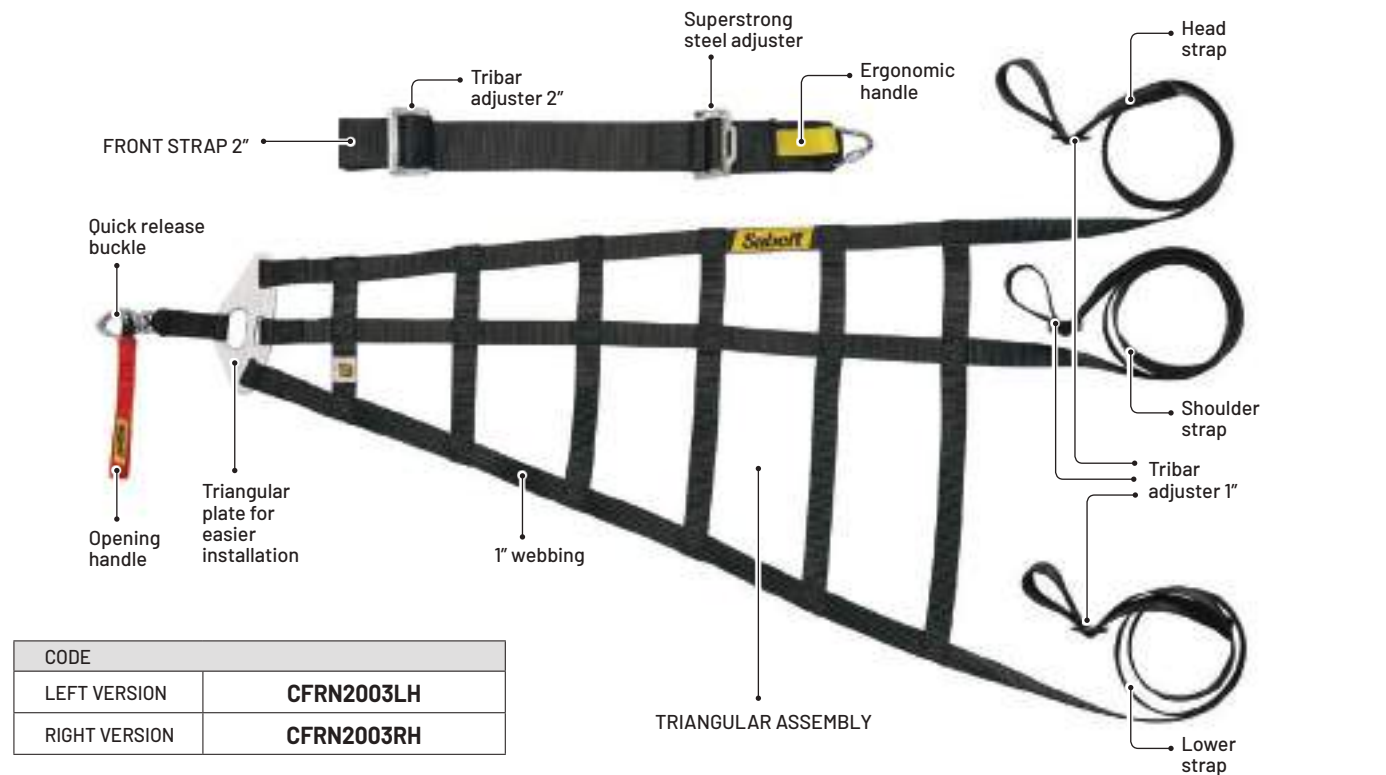

CODE	
LEFT VERSION	CFRN2003LH
RIGHT VERSION	CFRN2003RH

CFRN2002 (Universal Steel)

RACING NET

FIA APPROVED
 MANUFACTURER: SABELT
 MODEL: CFRN2002
 HOM. NO: RN.020.20
 FIA STANDARD: 8863-2013

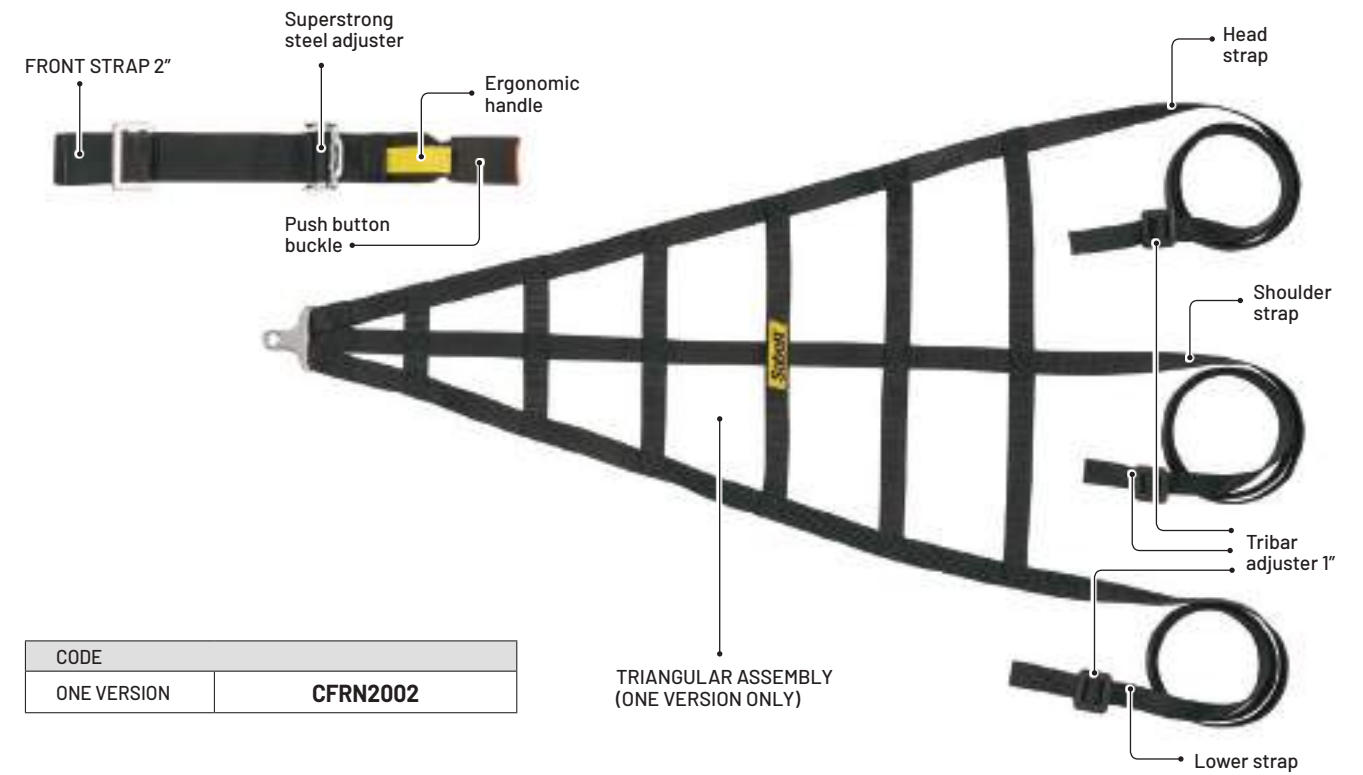

CODE	
ONE VERSION	CFRN2002

Z280988

WINDOW NET

Professional window net.

- Rollcage fixing clamps
- Rigid metal bars
- Quick release with push button
- Tightening adjusters
- Polyester webbing

In compliance with Fia regulation.



Z280985

WINDOW NET

Professional window net

- Red webbing opening System
- Tightening adjusters
- Rollcage mounting
- Polyester webbing

In compliance with Fia regulation.

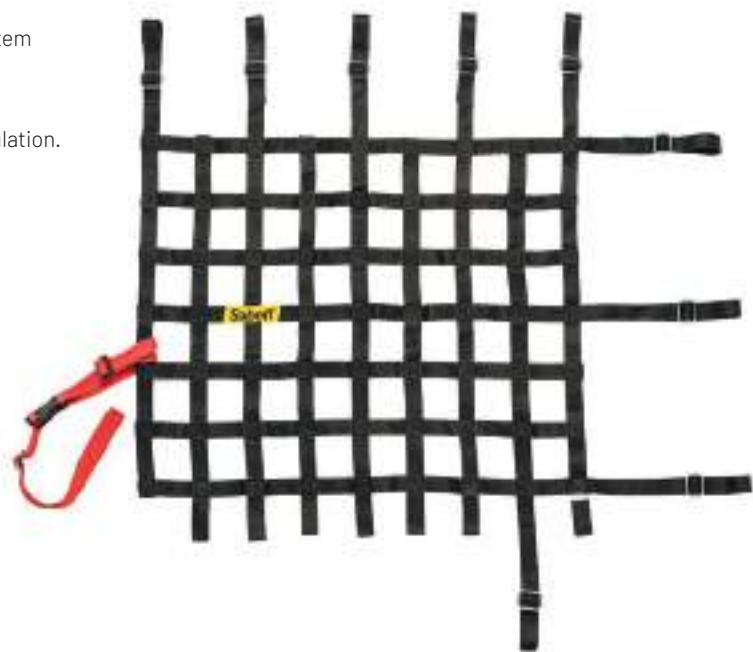

SEATS



RENAULT
OFFICIAL SUPPLIER

FIA 8862-2009

GT/RALLY/CIRCUIT

**GT-PRO**

- Shell: CARBON
- Fixing: BRACKETS
- Size: M-L-XL

**GT-635**

- Shell: CARBON
- Fixing: BRACKETS
- Size: M-L-XL

SFI 39.1

NASCAR

**GT-910**

- Shell: CARBON
- Fixing: BRACKETS
- Size: M

CIRCUIT ONLY

**GT-X GT3**

- Shell: CARBON
- Fixing: SIDE + REAR BRACKETS
- Size: M-L-XL

NEW**GT-X CHP**

- Shell: CARBON
- Fixing: BRACKETS
- Size: M-L-XL

NEW**GT-MCL**

- Shell: CARBON
- Fixing: SIDE + REAR BRACKETS
- Size: L-XL

NEW**GT-PRO XL 6-POINT**

- Shell: CARBON
- Fixing: SIDE + REAR BRACKETS
- Size: XL

**GT-635**

- Shell: CARBON
- Fixing: BRACKETS/SLIDING TRACKS
- Size: M-L-XL

FIA 8855-2021 • NEW HOMOLOGATION

HEAD PROTECTION

**SPINE**

- Shell: FIBERGLASS
- Fixing: BRACKETS
- Size: M-L-XL

**GT-AM**

- Shell: FIBERGLASS
- Fixing: BRACKETS
- Size: M-L-XL

FIA 8855-1999

HEAD PROTECTION

**X-PAD CARBON**

- Shell: CARBON
- Fixing: BRACKETS
- Size: L

**X-PAD RALLYCROSS**

- Shell: FIBERGLASS
- Fixing: BRACKETS
- Size: L

**X-PAD**

- Shell: FIBERGLASS
- Fixing: BRACKETS
- Size: L

**GT-PAD**

- Shell: FIBERGLASS
- Fixing: BRACKETS
- Size: M-L-XL

**TAURUS**

- Shell: FIBERGLASS
- Fixing: BRACKETS
- Size: M-L-XL

NO HEAD PROTECTION

**TITAN**

- Shell: FIBERGLASS
- Fixing: BRACKETS
- Size: XL

**GT-3**

- Shell: FIBERGLASS
- Fixing: BRACKETS
- Size: L

KIT - SPINE

THE KIT INCLUDES ALL THE PADS VISIBLE IN THE PICTURE

COLOUR	SIZE	CODE
■	M-35	RCSPINEPADMN
■	L-25	RCSPINEPADLN
■	XL-15	RCSPINEPADXLN



CUSHIONS - GT-PRO / GT-AM



S3
Seatback cushion th. 20 mm
RRGTPRO0014



S2
Size pads
th. 10 mm RRGTPRO0041
th. 20 mm RRGTPRO0042
th. 25 mm RRGTPRO0043
th. 30 mm RRGTPRO0044



CS5
Seat cushion
th. 20 mm RRGTPRO0015
th. 40 mm RRGTPRO0040



CS4
Seat cushion
th. 20 mm RRGTPRO0016
th. 40 mm RRGTPRO0045

CUSHIONS - TITAN / TAURUS



S1
Seatback cushion th. 20 mm
TITAN RRTITAU002_A
TITAN MAX RRTITAU003_A
TAURUS RRTITAU002_A
TAURUS MAX RRTITAU003_A



CS1
Lower cushion th. 20 mm
TITAN RRTITAU004_A
TITAN MAX RRTITAU007_A
TAURUS RRTITAU004_A
TAURUS MAX RRTITAU007_A



CS2
Lower cushion th. 40 mm
TITAN RRTITAU005_A
TITAN MAX RRTITAU008_A
TAURUS RRTITAU005_A
TAURUS MAX RRTITAU008_A



CS3
Lower cushion th. 50 mm
TITAN RRTITAU006_A
TITAN MAX RRTITAU009_A
TAURUS RRTITAU006_A
TAURUS MAX RRTITAU009_A



PG1
Leg cushion th. 40 mm
TITAN RRTITAU010_A
TITAN MAX RRTITAU012_A
TAURUS RRTITAU010_A
TAURUS MAX RRTITAU012_A



PG2
Leg cushion th. 50 mm
TITAN RRTITAU011_A
TITAN MAX RRTITAU013_A
TAURUS RRTITAU011_A
TAURUS MAX RRTITAU013_A



CPR
Lower back support
RRTITAU014_A



CL
Lumbar support
RRTITAU001_A

FIXING BRACKETS

**F1**

Steel brackets, th. 3mm, in compliance with FIA.
Z200087_A

**F2**

Aluminium brackets, th. 5 mm, in compliance with FIA.
Z200005_C

**F3**

Sliding tracks, travel 230 mm. No FIA.
Z200002_A

**F16** **NEW**

Steel brackets for GT-X CHP.
Fia Homologated 8862-2009. Bolts included.
TUTTE _KIT

**F17** **NEW**

Steel brackets for GT-MCL.
Fia Homologated 8862-2009. Bolts included.
RFST0067LH_KIT - RTST0067RH_KIT

**F17 bis** **NEW**

Steel brackets for GT-MCL.
Fia Homologated 8862-2009. Bolts included.
RFST0068_KIT

**F4**

Steel brackets for GT-635. Fia Homologated 8862-2009. Bolts included.
Note: Specify the seat size during the order.
RCST635FIX _KIT

**F5**

Sliding tracks for GT-635. Fia Homologated 8862-2009. Bolts included.
Size M: RCST635SLIDINGM _KIT
Size L/XL: RCST635SLIDINGXL _KIT

**F8**

Brackets for GT-PRO M. Fia Homologated 8862-2009. Bolts included.
RFST0025 _KIT

**F17 ter** **NEW**

Steel Brackets for GT-MCL.
Fia Homologated 8862-2009
MUST BE BOUGHT IN EVEN NUMBERS

**F18** **NEW**

Steel Brackets for GT-AM specific for F458.
NOT HOMOLOGATED
RFST0041

**F19** **NEW**

Steel Brackets specific for GT-PROXL for porsche 991GT3 - 992GT3R. Fia Homologated.
RFST0082

**F11**

Brackets for GT-PRO XL. Fia Homologated 8862-2009. Bolts included.
RFST0032 _KIT - RFST0033 _KIT
RFST0036 _KIT - RFST0038 _KIT
RFST0047 _KIT

**F12**

Steel bracket for 8855-2021 homologated seats. Bolts included.
RFST0071 _KIT

**F12 bis** **NEW**

Steel bracket for 8855-2021 homologated seats. Bolts included.
RFST0051 _KIT

**F12 ter** **NEW**

Steel bracket for 8855-2021 homologated seats. Bolts included.
RFST0095 _KIT

**F13** **NEW**

Steel brackets for GT-X GT3.
Fia Homologated 8862-2009. Bolts included.
RFST0049 _KIT - RFST0091 _KIT
RFST0093 _KIT

**F15** **NEW**

Sliding tracks for GT-X CHP. Fia Homologated 8862-2009. Bolts included.
Size M: RFST0077_KIT
Size L/XL: RFST0078_KIT

UNIVERSAL BRACKET

Compatible with all seats

**F14**

Universal seat subframe to be adapted to the vehicle body floor according to FIA 253-65B Annex J instructions.
- 2x 35 mm squared section pipes
- 4x end plates (90x45) mm
- 4x steel plates (110x65) mm
- 4x M8 bushing
RFST0079

LEGEND SEAT DIMENSIONS CHART

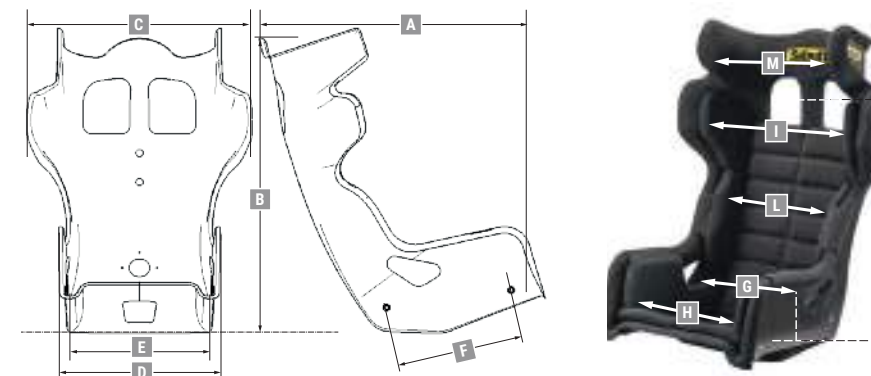

SHELL DIMENSIONS (mm)

A	Length
B	Height
C	External shoulder width
D	External lower frontal width
E	External lower rear width
F	Lateral interaxis distance
📦	Shell weight (kg)

INTERNAL SEAT DIMENSIONS (mm)

G	Rear lower cushion width
H	Frontal lower cushion width
I	Internal shoulder width
L	Central seatback width
M	Internal head protection width
N	Central bezel height
👤	Seat weight (kg)

8862-2009 / 8855-2021

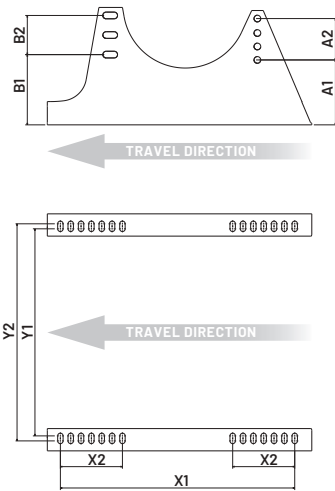

8855-1999

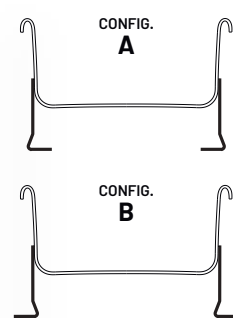
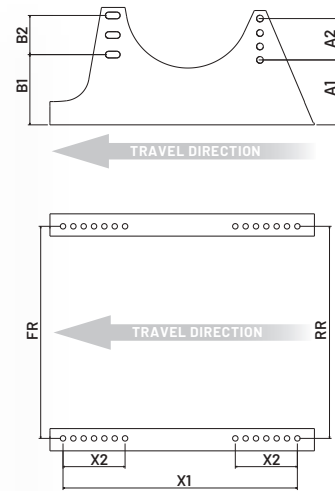

8862-2009

GTPRO															
		A1(mm)	A2(mm)	B1(mm)	B2(mm)	Y1(mm)	Y2(mm)	X1(mm)	X2(mm)	CHASSIS FIXING			SEAT FIXING		
										SCREW	Q.TY	STRENGTH CLASS	SCREW	Q.TY	STRENGTH CLASS
F8	RFST0025	58,5	20	105	22	428,5	435,5	406,5	40	M8	8	12,9	M12	4	12,9
	RFST0028	73		119,5	22,5	416	448	406,5	40	M8	8	12,9	M12	4	12,9
F11	RFST0032	67,5	30	84,5	60	475,4	488,4	401	59	M8	8	12,9	M12	4	12,9
	RFST0033	127	30	144	60	475,4	488,4	401	59	M8	8	12,9	M12	4	12,9
	RFST0036	94	/	124,5	23	418,5	445	406,5	40	M8	8	12,9	M12	4	12,9
	RFST0038	50,5	20	84	20	473	483	391,8	40	M8	8	12,9	M12	4	12,9
	RFST0047	90,5	20	124	40	472,7	482,5	391,8	40	M8	8	12,9	M12	4	12,9
F19	RFST0082	127	27	113,5	42	409	-	390	-	M10	4	10,9	M12	4	12,9

GT-MCL															
		A1(mm)	A2(mm)	B1(mm)	B2(mm)	Y1(mm)	Y2(mm)	X1(mm)	X2(mm)	CHASSIS FIXING			SEAT FIXING		
										SCREW	Q.TY	STRENGTH CLASS	SCREW	Q.TY	STRENGTH CLASS
F17	RFST0067_Lh+Rh	125	12	145	50	398	414	423	80	m8	4	12,9	M12	4	12,9

GT-635 M e XL															
		A1(mm)	A2(mm)	B1(mm)	B2(mm)	Y1(mm)	Y2(mm)	X1(mm)	X2(mm)	CHASSIS FIXING			SEAT FIXING		
										SCREW	Q.TY	STRENGTH CLASS	SCREW	Q.TY	STRENGTH CLASS
F4	RFST0011	106	18	146	34	432		406,5	40	M8	8	12,9	M12	4	12,9
F5	RFST635M_A RFST635XL_A	106	18	146	34	432		406,5		M8	8	12,9	M12	4	12,9

GT-X															
		A1(mm)	A2(mm)	B1(mm)	B2(mm)	Y1(mm)	Y2(mm)	X1(mm)	X2(mm)	CHASSIS FIXING			SEAT FIXING		
										SCREW	Q.TY	STRENGTH CLASS	SCREW	Q.TY	STRENGTH CLASS
F13	RSFT0049	90	20	159	20	405	375	360	60	M8	8	12,9	M12	4	12,9
F15	RFST0078_KIT	78	20	145	60	473,5	490	461		M10	4	10,9	M12	4	12,9
	RFST0077_KIT	78	20	145	60	473,5	490	461		M10	4	10,9	M12	4	12,9
F16	RFST0083_KIT	78	20	145	60	473,5	490	461		M10	4	10,9	M12	4	12,9

8855-2021

SPINE															
	CONFIG.	A1(mm)	A2(mm)	B1(mm)	B2(mm)	Y1(mm)	Y2(mm)	X1(mm)	X2(mm)	CHASSIS FIXING			SEAT FIXING		
										SCREW	Q.TY	STRENGTH CLASS	SCREW	Q.TY	STRENGTH CLASS
F12	RFST0051	A	102	75,5	80	399	419	414	125	M10	4	12,9	M12	4	12,9
F12	RFST0071	B	110	195	110	188	399	419	537	M10	4	10,9	M12	4	12,9
F12	RFST0095	A	122	78	108	78	437	473	519	M10	4	10,9	M12	4	12,9

SPINE M															
	CONFIG.	A1(mm)	A2(mm)	B1(mm)	B2(mm)	Y1(mm)	Y2(mm)	X1(mm)	X2(mm)	CHASSIS FIXING			SEAT FIXING		
										SCREW	Q.TY	STRENGTH CLASS	SCREW	Q.TY	STRENGTH CLASS
F12	RFST0051	A	102	75,5	80	404	436	414	125	M10	4	12,9	M12	4	12,9
F12	RFST0071	B	110	195	110	188	350	366	537	M10	4	10,9	M12	4	12,9
F12	RFST0095	A	122	78	108	78	390	426	519	M10	4	10,9	M12	4	12,9

GT-AM															
	CONFIG.	A1(mm)	A2(mm)	B1(mm)	B2(mm)	Y1(mm)	Y2(mm)	X1(mm)	X2(mm)	CHASSIS FIXING			SEAT FIXING		
										SCREW	Q.TY	STRENGTH CLASS	SCREW	Q.TY	STRENGTH CLASS
F12 bis	RFST0051		102	75,5	80	413	429	414	125	M10	4	12,9	M12	4	12,9
F12	RFST0071	A	110	195	110	188	413	429	537	M10	4	12,9	M12	4	12,9
F18	RFST0041	A	103	45,5	90	79,5	427	386,5	61,5	M8	4		M12	4	12,9

NOT FIA HOMOLOGATED

8855-1999

X-PAD														
		CONFIG.	A1(mm)	A2(mm)	B1(mm)	B2(mm)	FR(mm)	RR(mm)	X1(mm)	X2(mm)	CHASSIS FIXING		SEAT FIXING	
											SCREW	Q.TY	SCREW	Q.TY
F1	Z200087_A	A	70,5	54	72	72	356	349	329,5	36	M8	4	M8	4
	Z200087_A	B	70,5	54	72	72	444	438	329,5	36	M8	4	M8	4
F2	Z20005_C	A	63	79,5	63	79,5	348	343,4	324	34	M8	4	M8	4
	Z20005_C	B	63	79,5	63	79,5	456	447,6	324	34	M8	4	M8	4

GT-PAD														
		CONFIG.	A1(mm)	A2(mm)	B1(mm)	B2(mm)	FR(mm)	RR(mm)	X1(mm)	X2(mm)	CHASSIS FIXING		SEAT FIXING	
											SCREW	Q.TY	SCREW	Q.TY
F1	Z200087_A	A	70,5	54	72	72	426	418	329,5	36	M8	4	M8	4
	Z200087_A	B	70,5	54	72	72	518	508	329,5	36	M8	4	M8	4
F2	Z20005_C	A	63	79,5	63	79,5	422	415	324	34	M8	4	M8	4
	Z20005_C	B	63	79,5	63	79,5	534	518	324	34	M8	4	M8	4

TAURUS M														
		CONFIG.	A1(mm)	A2(mm)	B1(mm)	B2(mm)	FR(mm)	RR(mm)	X1(mm)	X2(mm)	CHASSIS FIXING		SEAT FIXING	
											SCREW	Q.TY	SCREW	Q.TY
F1	Z200087_A	A	70,5	54	72	72	352,6	335,3	329,5	36	M8	4	M8	4
	Z200087_A	B	70,5	54	72	72	441,8	424,5	329,5	36	M8	4	M8	4
F2	Z20005_C	A	63	79,5	63	79,5	345,2	329,9	324	34	M8	4	M8	4
	Z20005_C	B	63	79,5	63	79,5	453,2	433,9	324	34	M8	4	M8	4

TAURUS L														
		CONFIG.	A1(mm)	A2(mm)	B1(mm)	B2(mm)	FR(mm)	RR(mm)	X1(mm)	X2(mm)	CHASSIS FIXING		SEAT FIXING	
											SCREW	Q.TY	SCREW	Q.TY
F1	Z200087_A	A	70,5	54	72	72	358,8	350,7	329,5	36	M8	4	M8	4
	Z200087_A	B	70,5	54	72	72	448	439,9	329,5	36	M8	4	M8	4
F2	Z20005_C	A	63	79,5	63	79,5	351,4	345,3	324	34	M8	4	M8	4
	Z20005_C	B	63	79,5	63	79,5	459,4	449,3	324	34	M8	4	M8	4

TAURUS XL														
		CONFIG.	A1(mm)	A2(mm)	B1(mm)	B2(mm)	FR(mm)	RR(mm)	X1(mm)	X2(mm)	CHASSIS FIXING		SEAT FIXING	
											SCREW	Q.TY	SCREW	Q.TY
F1	Z200087_A	A	70,5	54	72	72	381,5	350,7	329,5	36	M8	4	M8	4
	Z200087_A	B	70,5	54	72	72	470,7	439,9	329,5	36	M8	4	M8	4
F2	Z20005_C	A	63	79,5	63	79,5	374,1	345,3	324	34	M8	4	M8	4
	Z20005_C	B	63	79,5	63	79,5	482,1	449,3	324	34	M8	4	M8	4

TITAN XL														
		CONFIG.	A1(mm)	A2(mm)	B1(mm)	B2(mm)	FR(mm)	RR(mm)	X1(mm)	X2(mm)	CHASSIS FIXING		SEAT FIXING	
											SCREW	Q.TY	SCREW	Q.TY
F1	Z200087_A	A	70,5	54	72	72	382,3	373,9	329,5	36	M8	4	M8	4
	Z200087_A	B	70,5	54	72	72	471,5	463,1	329,5	36	M8	4	M8	4
F2	Z20005_C	A	63	79,5	63	79,5	374,9	368,5	324	34	M8	4	M8	4
	Z20005_C	B	63	79,5	63	79,5	482,9	472,5	324	34	M8	4	M8	4

GT-3														
		CONFIG.	A1(mm)	A2(mm)	B1(mm)	B2(mm)	FR(mm)	RR(mm)	X1(mm)	X2(mm)	CHASSIS FIXING		SEAT FIXING	
											SCREW	Q.TY	SCREW	Q.TY
F1	Z200087_A	A	70,5	54	72	72	390,1	374,2	329,5	36	M8	4	M8	4
	Z200087_A	B	70,5	54	72	72	479,3	463,4	329,5	36	M8	4	M8	4
F2	Z20005_C	A	63	79,5	63	79,5	382,7	368,8	324	34	M8	4	M8	4
	Z20005_C	B	63	79,5	63	79,5	490,7	472,8	324	34	M8	4	M8	4

GT-PRO

8862-2009

GT/RALLY/CIRCUIT

CARBON	SHELL SIZE	FIXING	FIA
	M - XL	BRACKETS	8862-2009

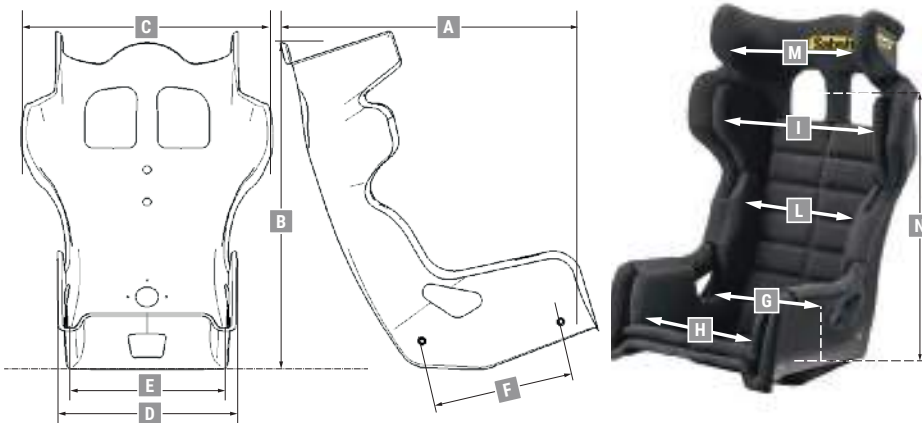

	Sizes		
	M	L	XL
SHELL DIMENSIONS (mm)			
A	825	795	
B	770	770	
C	625	644	
D	443	482	
E	389	427	
F	340	340	
Ⓜ	8,5*	9,3*	
INTERNAL SEAT DIMENSIONS (mm)			
G	302	325	340
H	343	335	350
I	430	440	450
L	321	340	370
M	328	330	330
N	512	512	512
Ⓜ	10,1	11,2	11,2

* Shell weight ± 10%



FIXING BRACKETS



FLOOR FIXING

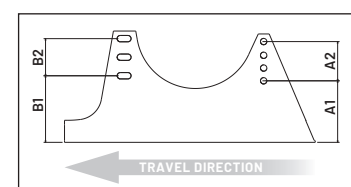

SEE SCHEME ON PAGE 76



• Size: **M**
• Cod: **RFSEGTPROPADM**



MANUFACTURER: SABELT
MODEL: GT-PRO M
HOM. NO: AS.081.19
FIA STANDARD: 8862-2009

• Size: **L**
• Cod: **RFSEGTPROPADL**



MANUFACTURER: SABELT
MODEL: GT-PRO L
HOM. NO: AS.086.20
FIA STANDARD: 8862-2009

• Size: **XL**
• Cod: **RFSEGTPROPADXL**



MANUFACTURER: SABELT
MODEL: GT-PRO XL
HOM. NO: AS.086.20
FIA STANDARD: 8862-2009

GT-635

8862-2009

CIRCUIT ONLY (with sliding tracks) - GT/RALLY/CIRCUIT (with fixed brackets)

CARBON	SHELL SIZE	FIXING	FIA
	M - XL	BRACKETS	8862-2009

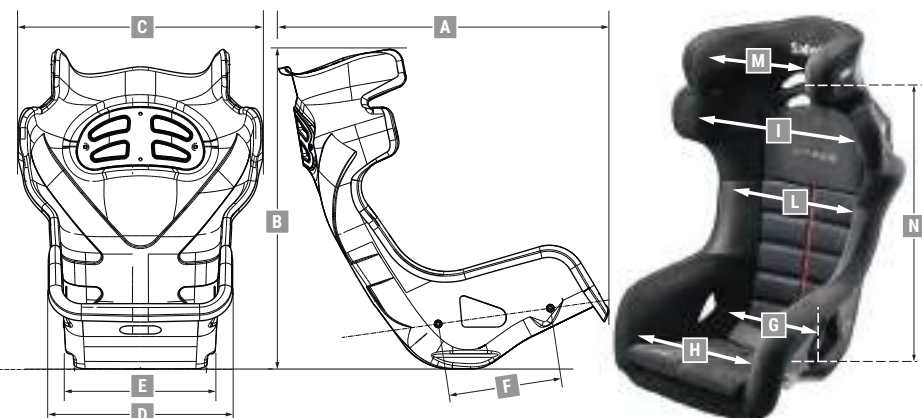

	Sizes		
	M	L	XL
SHELL DIMENSIONS (mm)			
A	530	540	
B	910	930	
C	656	676	
D	472	502	
E	400	430	
F	290	290	
⊞	8,4*	11,3*	
INTERNAL SEAT DIMENSIONS (mm)			
G	316	337	357
H	349	364	384
I	541	546	566
L	368	417	437
M	317	325	325
N	670	656	656
⊞	10,9	13,8	13,5

* Shell weight ± 10%

SPARES AND ACCESSORIES



KF



MP

CPR

CL

FIXING BRACKETS



F4 GT/CIRCUIT



F5 CIRCUIT ONLY

FLOOR FIXING

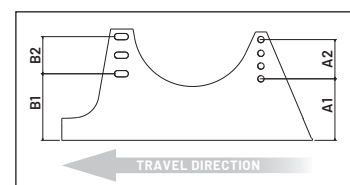

SEE SCHEME ON PAGE 76



• CIRCUIT ONLY

• with sliding tracks

• Size: **M**

• Cod: **RFSEGT635DMN**



MANUFACTURER: SABELT
MODEL: GT-635 M
HOM. NO: AS.057.16
FIA STANDARD: 8862-2009

• Size: **L**

• Cod: **RFSEGT635DLN**



MANUFACTURER: SABELT
MODEL: GT-635 XL
HOM. NO: AS.058.16
FIA STANDARD: 8862-2009

• Size: **XL**

• Cod: **RFSEGT635DXLN**



MANUFACTURER: SABELT
MODEL: GT-635 XL
HOM. NO: AS.058.16
FIA STANDARD: 8862-2009

• GT/RALLY/CIRCUIT

• with fixed brackets

• Size: **M**

• Cod: **RFSEGT635MN**



MANUFACTURER: SABELT
MODEL: GT-635 M
HOM. NO: AS.060.16
FIA STANDARD: 8862-2009

• Size: **L**

• Cod: **RFSEGT635LN**



MANUFACTURER: SABELT
MODEL: GT-635 XL
HOM. NO: AS.061.16
FIA STANDARD: 8862-2009

• Size: **XL**

• Cod: **RFSEGT635XLN**



MANUFACTURER: SABELT
MODEL: GT-635 XL
HOM. NO: AS.061.16
FIA STANDARD: 8862-2009

GT-X GT3

8862-2009

CIRCUIT ONLY

Developed with Ferrari Competizioni GT

CARBON	SHELL SIZE	FIXING	FIA
	M - XL	BRACKETS	8862-2009

	Sizes		
	M	L	XL
SHELL DIMENSIONS (mm)			
A	456	479	
B	848	848	
C	606	606	
D	458	458	
E	418	418	
F	340	340	
Ⓜ	10*	10,5*	
INTERNAL SEAT DIMENSIONS (mm)			
G	310	320	340
H	320	330	350
I	410	425	445
L	290	300	320
M	350	350	350
N	710	710	720
Ⓜ	12,5	13,5	13,5

* Shell weight ± 10%

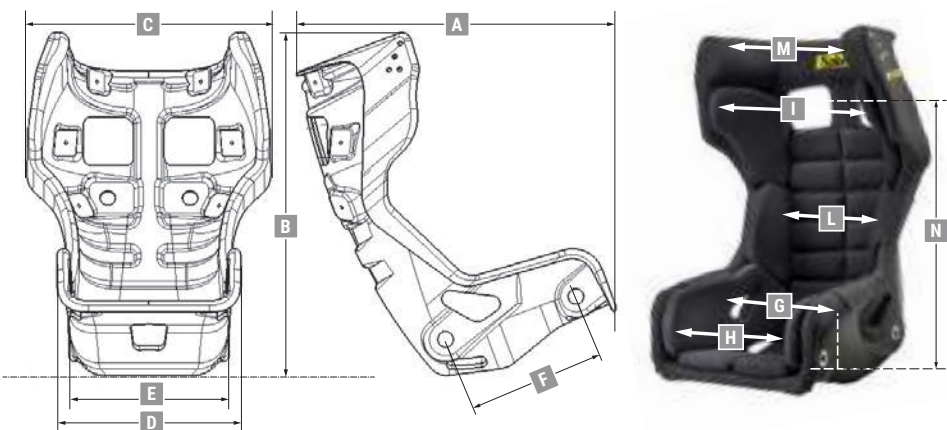

FIXING BRACKETS



F13



6 POINTS BRACKETS
For more details please contact Sabelt Directly

FLOOR FIXING

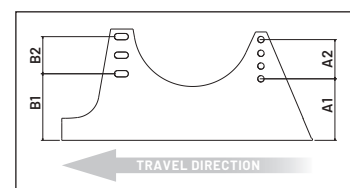

SEE SCHEME ON PAGE 76

• Size: M
• Cod: RFSEGTXTGT3M



MANUFACTURER: SABELT
MODEL: GT-X M
HOM. NO: AS.102.22
FIA STANDARD: 8862-2009

• Size: L
• Cod: RFSEGTXTGT3L



MANUFACTURER: SABELT
MODEL: GT-X L
HOM. NO: AS.101.22
FIA STANDARD: 8862-2009

• Size: XL
• Cod: RFSEGTXTGT3XL



MANUFACTURER: SABELT
MODEL: GT-X XL
HOM. NO: AS.101.22
FIA STANDARD: 8862-2009

GT-X CHP

8862-2009 **NEW**

CIRCUIT ONLY

CARBON	SHELL SIZE	FIXING	FIA
	M - XL	BRACKETS	8862-2009

	Sizes		
	M	L	XL
SHELL DIMENSIONS (mm)			
A	456	479	
B	848	848	
C	606	606	
D	458	458	
E	418	418	
F	340	340	
📏	10*	10,5*	
INTERNAL SEAT DIMENSIONS (mm)			
G	310	320	340
H	320	330	350
I	410	425	445
L	290	300	320
M	350	350	350
N	710	710	720
📏	12,5	13,5	13,5

* Shell weight ± 10%*

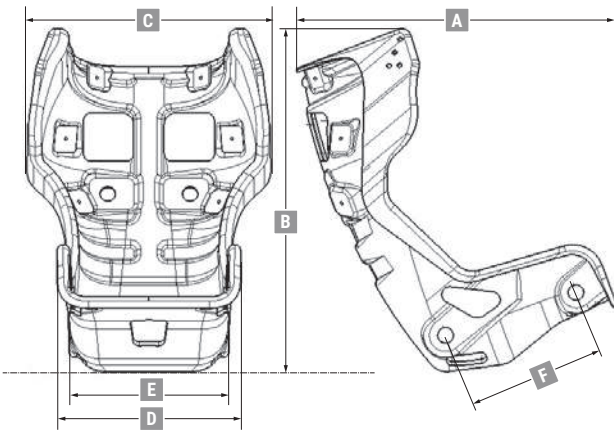

FIXING BRACKETS



F15



F16

FLOOR FIXING

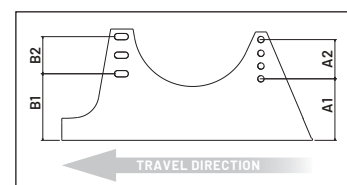

SEE SCHEME ON PAGE 76

• Size: M
• Cod: RFSEGTXCHPMPAD10



MANUFACTURER: SABELT
MODEL: GT-X CHP M
HOM. NO: AS.106.23
FIA STANDARD: 8862-2009

• Size: L
• Cod: RFSEGTXCHPLPAD20



MANUFACTURER: SABELT
MODEL: GT-X CHP XL
HOM. NO: AS.105.23
FIA STANDARD: 8862-2009

• Size: XL
• Cod: RFSEGTXCHPXLPAD10



MANUFACTURER: SABELT
MODEL: GT-X CHP XL
HOM. NO: AS.105.23
FIA STANDARD: 8862-2009

GT-MCL

8862-2009 **NEW**

CIRCUIT ONLY

CARBON	SHELL SIZE	FIXING	FIA
	XL	BRACKETS	8862-2009

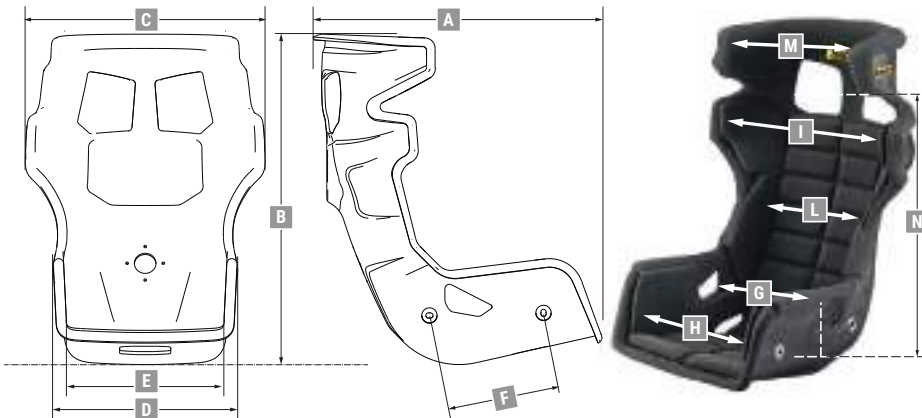

	L	XL
SHELL DIMENSIONS (mm)		
A	727,1	
B	851	
C	611,3	
D	465,2	
E	420,7	
F	293	
🔒	--*	
INTERNAL SEAT DIMENSIONS (mm)		
G	337,1	357,1
H	330	350
I	379,4	399,4
L	408,6	428,6
M	371,6	371,6
N	605,4	605,4
🔒	--	--

* Shell weight ± 10%



FIXING BRACKETS



F17



F17 bis



F17 ter

FLOOR FIXING

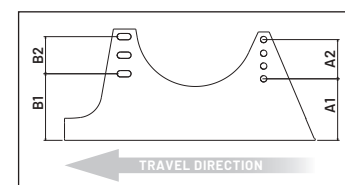

SEE SCHEME ON PAGE 76



• Size: L
 • Cod: RFGTFIFTYPADL

 MANUFACTURER: SABELT
 MODEL: GT-MCL
 HOM. NO.: AS.103.23
 FIA STANDARD: 8862-2009

• Size: XL
 • Cod: RFGTFIFTYPADXL

 MANUFACTURER: SABELT
 MODEL: GT-MCL
 HOM. NO.: AS.103.23
 FIA STANDARD: 8862-2009

GT-PRO XL 6-POINT

8862-2009

CIRCUIT ONLY

CARBON	SHELL SIZE	FIXING	FIA
	XL	BRACKETS	8862-2009

Sizes	
XL	
SHELL DIMENSIONS (mm)	
A	795
B	770
C	644
D	482
E	427
F	340
📏	9,3*
INTERNAL SEAT DIMENSIONS (mm)	
G	346
H	350
I	510
L	372
M	350
N	512
📏	11

* Shell weight ± 10%

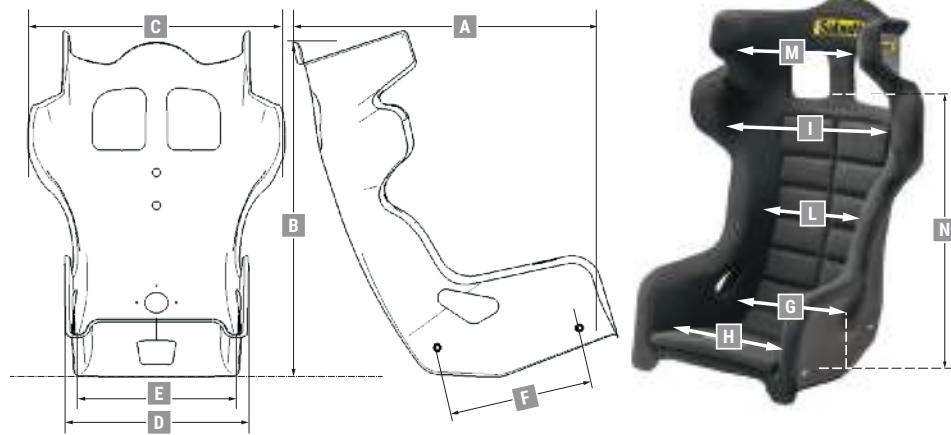

FIXING BRACKETS



F11



6 POINTS BRACKETS
For more details please contact Sabelt Directly

FLOOR FIXING

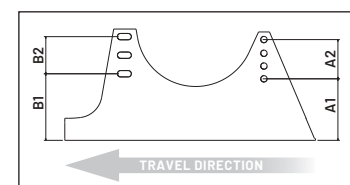

SEE SCHEME ON PAGE 76



• Size: **XL**
• Cod: **RFSEGTPROXP6PN**



MANUFACTURER: SABELT
MODEL: GT-PRO XL 6-POINT
HOM. NO: AS.087.20
FIA STANDARD: 8862-2009

GT-910

SFI 39.1

NASCAR

CARBON	SHELL SIZE	SFI
	M	39.1

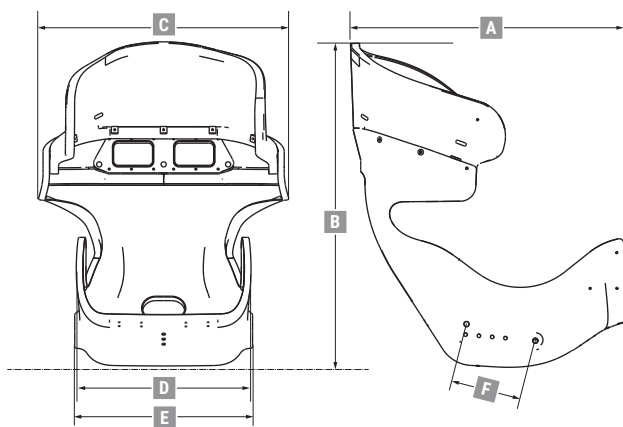

Sizes	
M	
SHELL DIMENSIONS (mm)	
A	779
B	925
C	714
D	499
E	508
F	202
📏	19,0*

Shell weight ± 10%



Full Carbon, Textreme external layer (unique design).
 Weight in compliance with new standards (42 lbs weight). Headrest included.
 Low COG (center of gravity).
 NASCAR Approved (69G sled test - SFI homologation - NASCAR 2015 quasi-static test).
 Shell made of seat + asymmetric headrest.
 Designed along with one of the most prestigious NASCAR Team.
 The seat is used and appreciated by several Top Drivers.



- Size: **M**
- SHELL - Cod: **RFGT910M**
- HEADREST - Cod: **RCGT911AM**
- HEADREST+1" - Cod: **RCGT913AM**

SPINE

8855-2021

FIBERGLASS	SHELL SIZE	FIXING	FIA
	NEW M - XL	BRACKETS	8855-2021

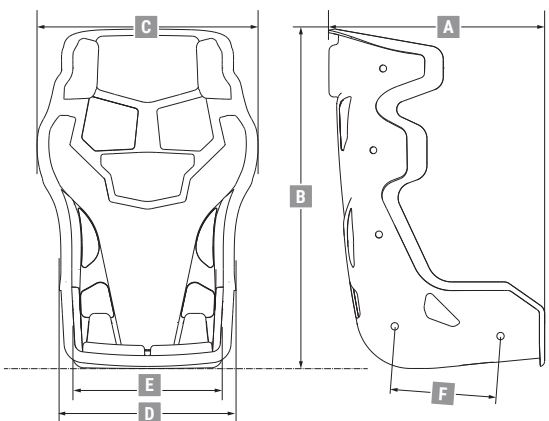

	Sizes					
	M			XL		
	Pads (mm)			Pads (mm)		
	M-35	L-25	XL-15	M-35	L-25	XL-15
SHELL DIMENSIONS (mm)						
A	670			670		
B	907			907		
C	583			627		
D	471,7			513,5		
E	390			436,5		
F	290			290		
⊞	10,8*			13,4*		
INTERNAL SEAT DIMENSIONS (mm)						
G	305	325	345	340	360	380
H	305	325	345	340	360	380
I	435	455	475	470	490	510
L	300	320	340	330	350	370
M	350	350	350	340	360	380
N	485	495	505	495	505	515
⊞	12,8*	12,8*	12,8*	15,4*	15,4*	15,4*

Shell weight ± 10%

PAD KITS

THE KIT INCLUDES ALL THE PADS VISIBLE IN THE PICTURE

COLOUR	SIZE	CODE
	M-35	RCSPINEPADMN
	L-25	RCSPINEPADLN
	XL-15	RCSPINEPADXLN



Racing Net Guide.
RFST0057_KIT



FIXING BRACKETS



F12



F12 bis



F12 ter

FLOOR FIXING

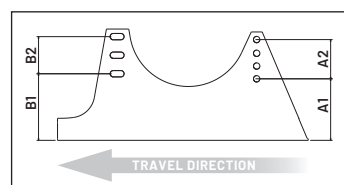

SEE SCHEME ON PAGE 76



* Attention: this code refers to the seat excluding the pad kits. The pad kits are provided/supplied separately.

• Size: **M**
• Cod: **RFSESPINEBASEM***

MANUFACTURER: SABELT
MODEL: SPINE
HOM. NO: CS.014.23
FIA STANDARD: 8855-2021

• Size: **XL**
• Cod: **RFSESPINEBASE***

MANUFACTURER: SABELT
MODEL: SPINE
HOM. NO: CS.011.22
FIA STANDARD: 8855-2021

GT-AM

8855-2021

FIBERGLASS	SHELL SIZE	FIXING	FIA
	XL	BRACKETS	8855-2021

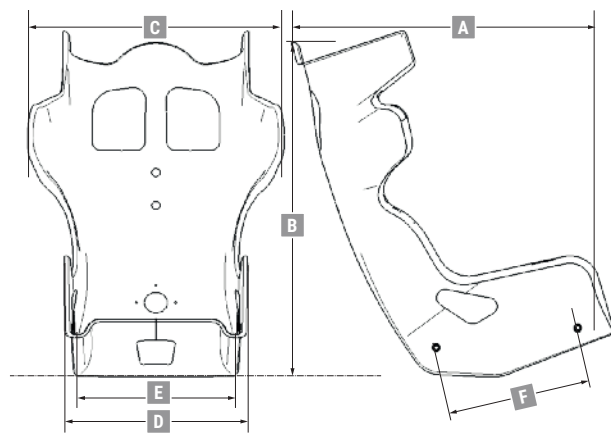

	Sizes		
	M	L	XL
SHELL DIMENSIONS (mm)			
A	795		
B	770		
C	644		
D	482		
E	427		
F	290		
Ⓜ	12*		
INTERNAL SEAT DIMENSIONS (mm)			
G	315	325	340
H	320	335	350
I	432	452	462
L	320	340	370
M	342	342	342
N	512	512	512
Ⓜ	16,9	16,9	16,9

* Shell weight ± 10%

PAD KITS

THE KIT INCLUDES ALL THE PADS VISIBLE IN THE PICTURE

COLOUR	SIZE	CODE
■	M	RRGTPR00043
■	L	RRGTPR00042
■	XL	RRGTPR00041



Racing Net Guide.
RFST0057_KIT



FIXING BRACKETS



F12



F12 bis



F18

FOR FERRARI 458 ONLY

FLOOR FIXING

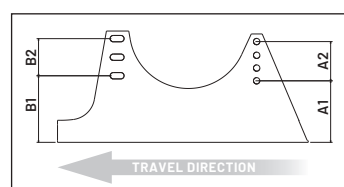

SEE SCHEME ON PAGE 76



* Attention: this code refers to the seat excluding the pad kits. The pad kits are provided/supplied separately.

• Size: **XL**
• Cod: **RFSEGTAMBASE***



MANUFACTURER: SABELT
MODEL: GT-AM
HOM. NO: CS.012.22
FIA STANDARD: 8855-2021

X-PAD CARBON

8855-1999

CARBON	SHELL SIZE	FIXING	FIA
	L	BRACKETS	8855-1999

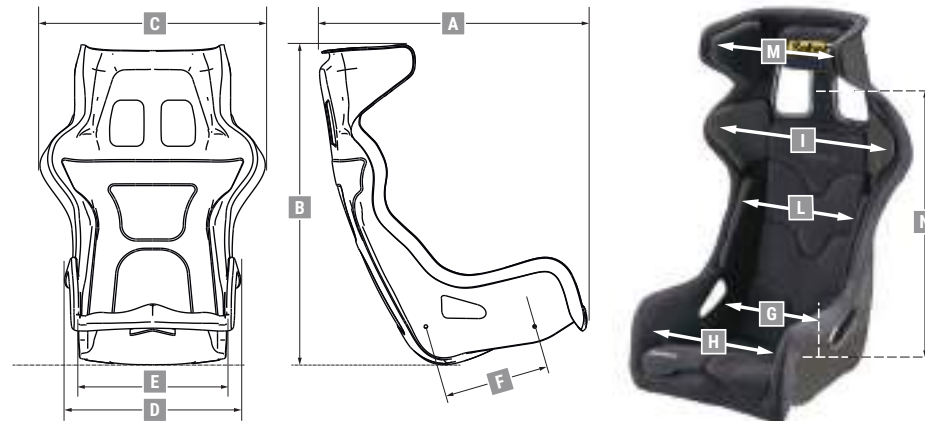

Sizes	
L	
SHELL DIMENSIONS (mm)	
A	550
B	900
C	600
D	396
E	390
F	290
🔒	4,9*
INTERNAL SEAT DIMENSIONS (mm)	
G	362
H	368
I	447
L	358
M	338
N	661
🔒	6,3

* Shell weight ± 10%

PAD KIT

THE KIT INCLUDES ALL THE PADS VISIBLE IN THE PICTURE

COLOUR	SIZE	CODE
■	L	RCXPADNR



FIXING BRACKETS



F1



F2

FLOOR FIXING

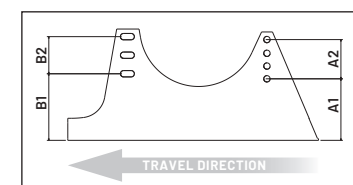

SEE SCHEME ON PAGE 76



• Size: L
• Cod: RFSEXPADCARBON



MANUFACTURER: SABELT
MODEL: X-PAD CARBON
HOM. NO: CS.418.19
FIA STANDARD: 8855-1999

X-PAD RALLYCROSS

8855-1999

RALLYCROSS

FIBERGLASS	SHELL SIZE	FIXING	FIA
	L	BRACKETS	8855-1999

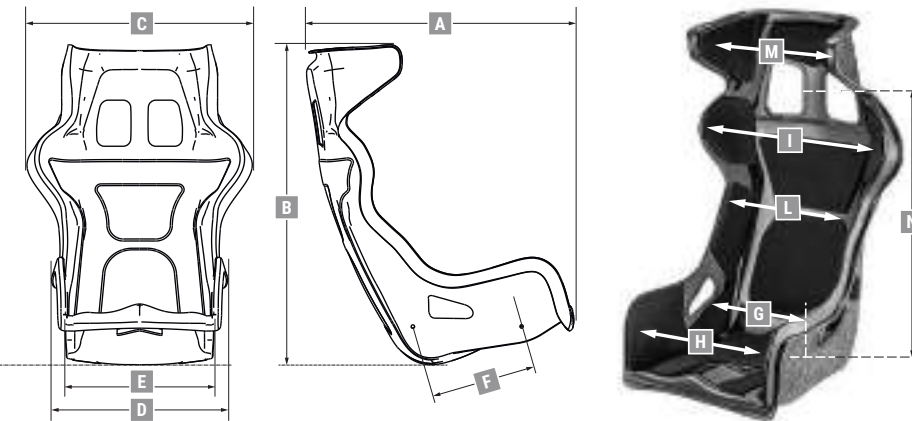

Sizes	
L	
SHELL DIMENSIONS (mm)	
A	550
B	900
C	600
D	396
E	390
F	290
⊥	6,5*
INTERNAL SEAT DIMENSIONS (mm)	
G	372
H	378
I	460
L	370
M	340
N	661
⊥	7,3

* Shell weight ± 10%

PAD KIT

THE KIT INCLUDES ALL THE PADS VISIBLE IN THE PICTURE

COLOUR	SIZE	CODE
■	L	RCXPADRCROSS3C

EXTRA 2 PADS 30 x 30 cm INCLUDED



FIXING BRACKETS



F1



F2

FLOOR FIXING

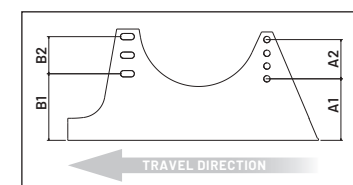

SEE SCHEME ON PAGE 76



EASY TO CLEAN

• Size: L
 • Cod: RFSEXPADRCROSS
 (SEAT ONLY WITHOUT PADDING KIT)

FIA APPROVED

MANUFACTURER: SABELT
 MODEL: X-PAD
 HOM. NO: CS.419.19-
 FIA STANDARD: 8855-1999

X-PAD

8855-1999

FIBERGLASS	SHELL SIZE	FIXING	FIA
	L	BRACKETS	8855-1999

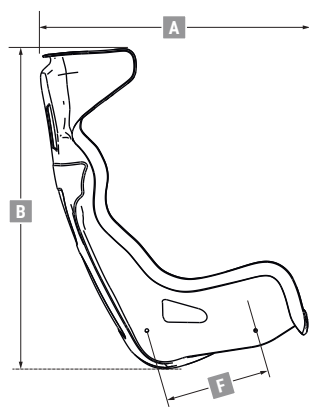
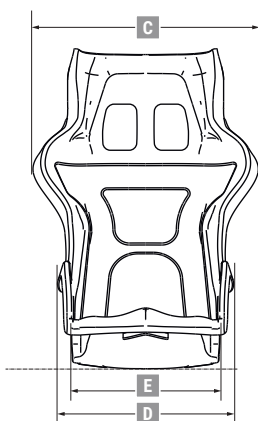

Sizes	
L	
SHELL DIMENSIONS (mm)	
A	550
B	900
C	600
D	396
E	390
F	290
Ⓛ	6,0*
INTERNAL SEAT DIMENSIONS (mm)	
G	362
H	368
I	447
L	358
M	338
N	661
Ⓛ	7,7

* Shell weight ± 10%

PAD KIT

THE KIT INCLUDES ALL THE PADS VISIBLE IN THE PICTURE

COLOUR	SIZE	CODE
■	L	RCXPADNR



FIXING BRACKETS



F1



F2

FLOOR FIXING

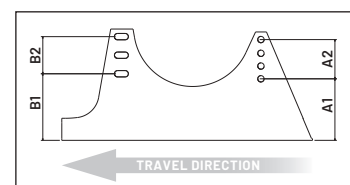

SEE SCHEME ON PAGE 76



• Size: L
• Cod: RFSEXPADNR



MANUFACTURER: SABELT
MODEL: X-PAD
HOM. NO: CS.419.19
FIA STANDARD: 8855-1999

GT-PAD

8855-1999

FIBERGLASS	SHELL SIZE	FIXING	FIA
	XL	BRACKETS	8855-1999

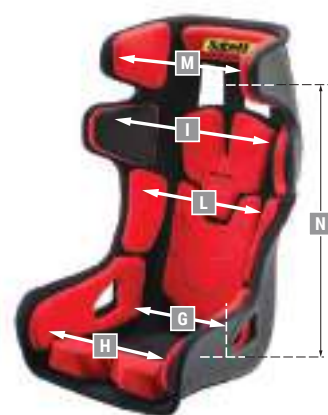
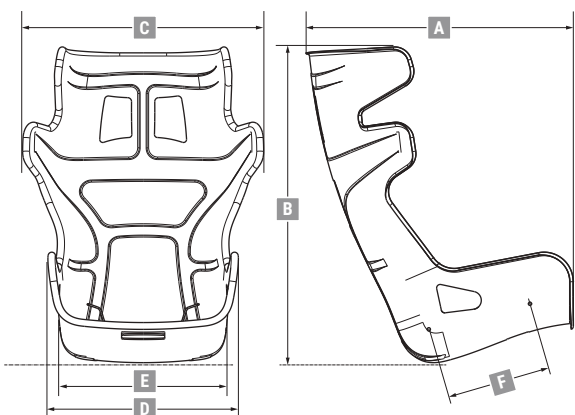

Sizes			
	M	L	XL
SHELL DIMENSIONS (mm)			
A		744	
B		878	
C		670	
D		529	
E		471	
F		290	
⊕		8,9*	
INTERNAL SEAT DIMENSIONS (mm)			
G	365	380	395
H	405	420	435
I	540	550	560
L	346	356	366
M	380	380	380
N	660	660	660
⊕	10,7	10,6	10,5

* Shell weight ± 10%

PAD KITS

THE KIT INCLUDES ALL THE PADS VISIBLE IN THE PICTURE

COLOUR	SIZE	CODE
Black	M	RCGTPADKITMN
Black	L	RCGTPADKITLN
Black	XL	RCGTPADKITXLN
Red	M	RCGTPADKITMR
Red	L	RCGTPADKITLR
Red	XL	RCGTPADKITXLR



FIXING BRACKETS



F1



F2

FLOOR FIXING

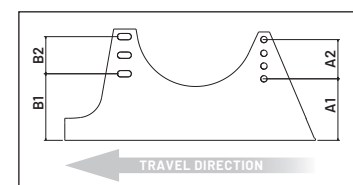

SEE SCHEME ON PAGE 76

* Attention: this code refers to the seat excluding the pad kits. The pad kits are provided/supplied separately.

• Size: XL

• Cod: RFSEGTPAD*



MANUFACTURER: SABELT
MODEL: GT-PAD
HOM. NO: CS.391.18
FIA STANDARD: 8855-1999

TAURUS

8855-1999

FIBERGLASS	SHELL SIZE	FIXING	FIA
	M - L - XL	BRACKETS	8855-1999

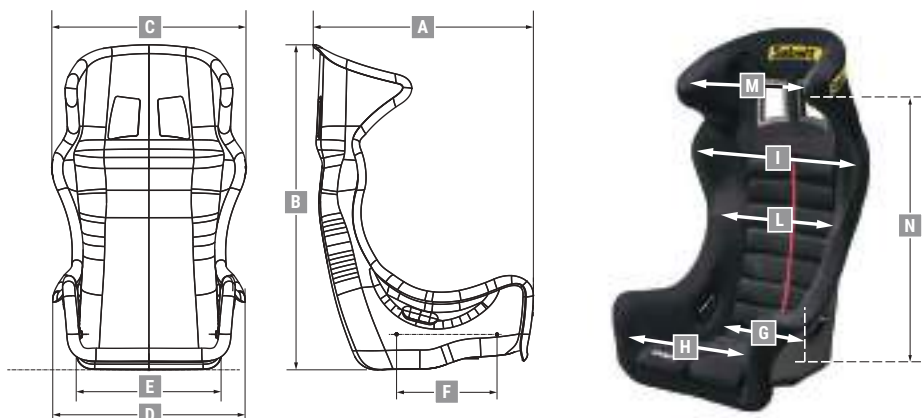

	Sizes		
	M	L	XL
SHELL DIMENSIONS (mm)			
A	543	550	586
B	925	979	980
C	579	582	588
D	475	481	519
E	377	392	411
F	290	290	290
⊞	8,4*	9,0*	9,7*
INTERNAL SEAT DIMENSIONS (mm)			
G	300	318	326
H	364	373	393
I	486	501	512
L	345	362	393
M	341	357	394
N	685	717	716
⊞	10,5	11,4	11,4

* Shell weight ± 10%

SPARES AND ACCESSORIES



FIXING BRACKETS

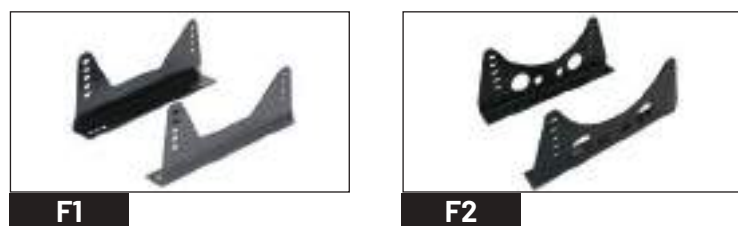

FLOOR FIXING

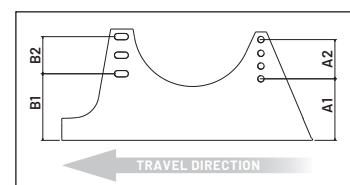

SEE SCHEME ON PAGE 76



• Size: **M**
 • Cod: **RFSETAURUSMN**

 MANUFACTURER: SABELT
 MODEL: TAURUS TG M
 HOM. NO: CS.368.17
 FIA STANDARD: 8855-1999

• Size: **L**
 • Cod: **RFSETAURUSN**

 MANUFACTURER: SABELT
 MODEL: TAURUS
 HOM. NO: CS.346.16
 FIA STANDARD: 8855-1999

• Size: **XL**
 • Cod: **RFSETAURUSMAXN**

 MANUFACTURER: SABELT
 MODEL: TAURUS MAX
 HOM. NO: CS.347.16
 FIA STANDARD: 8855-1999

TITAN

8855-1999

FIBERGLASS	SHELL SIZE	FIXING	FIA
	XL	BRACKETS	8855-1999

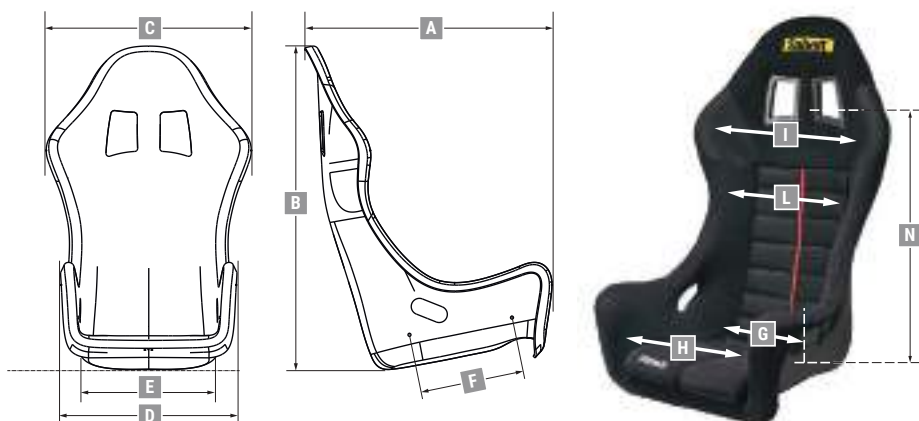

Sizes	
XL	
SHELL DIMENSIONS (mm)	
A	602
B	957
C	606
D	506
E	415
F	290
📏	7,8*
INTERNAL SEAT DIMENSIONS (mm)	
G	313
H	367
I	517
L	379
M	-
N	690
📏	9,9

* Shell weight ± 10%

SPARES AND ACCESSORIES



FIXING BRACKETS



F1



F2

FLOOR FIXING

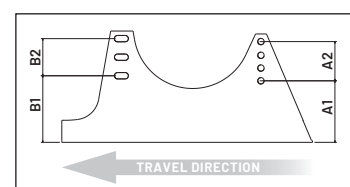

SEE SCHEME ON PAGE 76



• Size: **XL**
• Cod: **RFSETITANMAXN**



MANUFACTURER: SABELT
MODEL: TITAN MAX
HOM. NO: CS.350.16
FIA STANDARD: 8855-1999

GT-3

8855-1999

FIBERGLASS	SHELL SIZE	FIXING	FIA
	L	BRACKETS	8855-1999

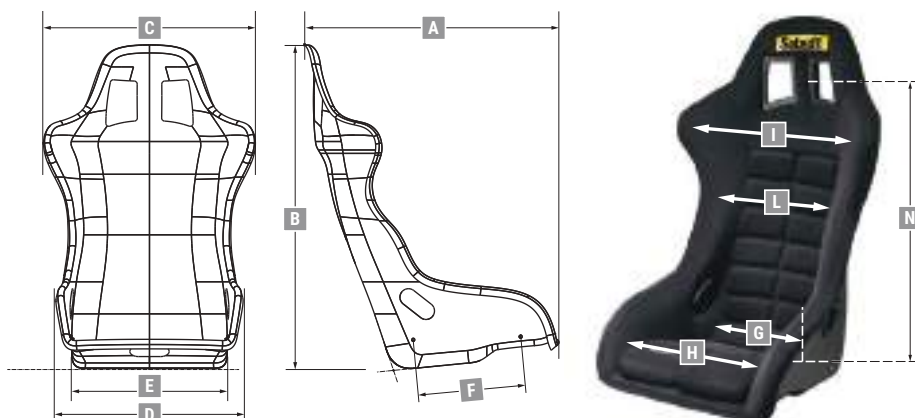

Sizes	
L	
SHELL DIMENSIONS (mm)	
A	460
B	920
C	592
D	539
E	416
F	290
⊕	7,2*
INTERNAL SEAT DIMENSIONS (mm)	
G	355
H	386
I	469
L	354
M	-
N	706
⊕	9,8

* Shell weight ± 10%

SPARES AND ACCESSORIES



FIXING BRACKETS

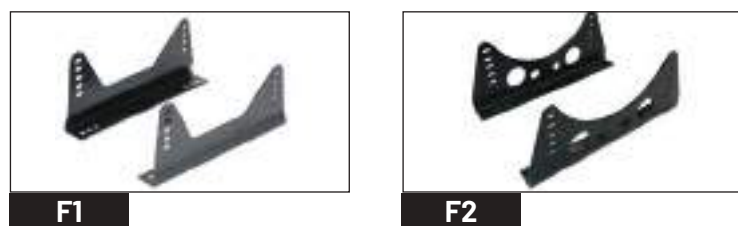

FLOOR FIXING

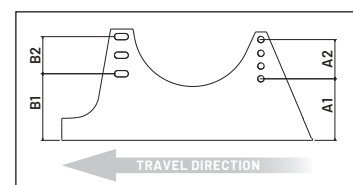

SEE SCHEME ON PAGE 76



• Size: L
• Cod: RFSEGT3N



MANUFACTURER: SABELT
MODEL: GT-3
HOM. NO: CS.355.17
FIA STANDARD: 8855-1999

RACEWEAR



24 Heures du Mans 2023 Winners!



COMPETIZIONI GT SPONSOR



SUITS



SHOES



GLOVES



UNDERWEAR



FIA 8856-2018

SUITS



HERO SUPERLIGHT TS-10



- Size: 46-66
- Weight: 265 g/m²
- SFI: 3.2A/5 - 3.4 available
- : available



HERO SUPERLIGHT WOMAN TS-10



- Size: 38-60
- Weight: 265 g/m²
- SFI: 3.2A/5 - 3.4 available
- : available



UNIVERSE TS-8



- Size: 44-66
- Weight: 310 g/m²
- : available



CHALLENGE TS-2



- Size: 44-66
- Weight: 360 g/m²
- SFI: 3.2A/5 - 3.4 available
- : available

FIA 8856-2018

GLOVES

GECKOTECH TG-11A **NEW**

- Size: 8-12



HERO SUPERLIGHT TG-10



- Size: 8-12



CHALLENGE TG-2.1



- Size: 8-12

CREW

SUITS



ROCKET TM-1

- Size: S-XXXL • Hom: n/a

ARMOR TM-2 **NEW**

- Size: XXS-XXXXL
- Hom: SFI 3.2A/5-3.4

UNDERWEAR



UI-600



- Balacava: ONE SIZE
- Top/Pant: XS-XXL (slim fit)
- Socks: 38-46



UI-600 RF



- Top/Pant: S-XXXL (regular fit)



UI-200



- Balacava: ONE SIZE
- Top/Pant: XS-XXL (slim fit)

PERSONAL UNDERWEAR



UI-300

- Short (M): XS-XXL
- Slipl (W): XS-XXL
- Bra: XS-XXL

SHOES



ZERO GRAVITY TB-11



- Size: 36-48



HERO PRO TB-10.1



- Size: 36-48



UNIVERSE TB-8



- Size: 36-48
- SFI: 3.3/5 available



CLASSIC TB-2



- Size: 36-46

ACCESSORIES

DAKAR TJ-1 **NEW**

- Size: XS-XXL



LASER TB-3



- Size: 36-48
- : available



LASER TG-3.1



- Size: 9-13
- : available

MADE TO MEASURE SUIT TEMPLATE

NAME: _____ FLAG: _____

HEIGHT: _____ WEIGHT: _____

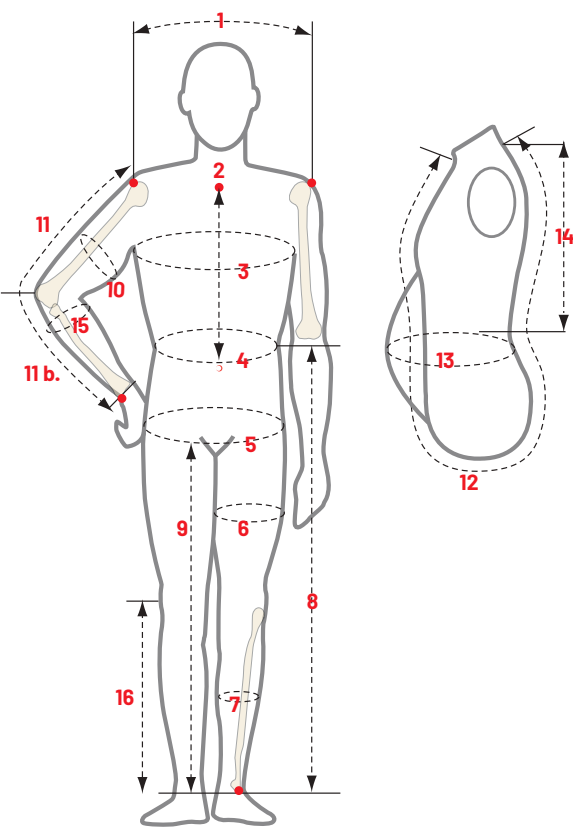

- 1 Shoulder breadth (from points of shoulders bones across back)
- 2 Body length from inside shoulder to waist
- 3 Maximum chest circumference
- 4 Waist circumference measured at the narrowest point
- 5 Hip circumference
- 6 Thigh circumference
- 7 Calf circumference
- 8 Outside leg length from waist to malleolus
- 9 Desired length from the crotch to ankle
- 10 Biceps circumference
- 11 Sleeve length from point of shoulder bone to wrist (arm bent)
- 11 b Forearm length from elbow to wrist
- 12 Crotch length from front collar bone through top of inside leg to back neck
- 13 Maximum waist circumference
- 14 Length from neck to waist
- 15 Forearm circumference
- 16 Length from the knee center to malleolus

1	4	7	10	12	15
2	5	8	11	13	16
3	6	9	11 b	14	

BELT: YES NO

DESIRED FIT: SLIMFIT REGULAR LOOSE

NASCAR BOOTCUT: YES NO

COOLING HOLE: YES NO ...if YES LEFT RIGHT

POCKETS: CELL. NORMAL NONE

LOGOS: PRINT EMBROIDERY

MECHANIC FEATURES: YES NO



DOUBLE BELT LOOP RADIO OR ACCESSORIES LOOP SHOULDER WIRE CORD BOOT CUT

SUITS - STANDARD SIZE CHART

Sizes listed are in cm and are for body measurements, not for the suit.

TS-10 (SLIM FIT) - SIZE	TS-2 (REGULAR FIT) - SIZE	CHEST	WAIST	HIPS	WEIGHT	HEIGHT	TS-1/ TM-1/TJ-1 SIZE	TM-2
-	-	72-78	60-65	73-77	31-36	n/a	-	XXS
-	-	78-82	65-69	77-81	37-42	n/a	-	-
-	44	82-86	69-73	81-85	43-48	160-163	XS	XS
46	46	86-90	73-77	85-89	49-54	164-166	-	-
48	48	90-94	77-81	89-93	55-60	167-169	S	S
50	50	94-98	81-85	93-97	61-66	170-172	-	-
52	52	98-102	85-89	97-101	67-72	173-175	M	M
54	54	102-106	89-93	101-105	73-78	176-179	-	-
56	56	106-110	93-97	105-109	79-84	180-184	L	L
58	58	110-114	97-101	109-113	85-90	185-187	-	-
60	60	114-118	101-105	113-117	91-96	188-190	XL	XL
62	62	118-122	105-109	117-121	97-102	191-193	-	-
64	64	122-126	109-113	121-125	103-108	194-196	XXL	XXL
66	66	126-130	113-117	125-129	109-114	197-199	-	-
-	-	130-134	117-121	129-133	115-118	n/a	XXXL	XXXL
-	-	134-138	121-125	133-137	119-122	n/a	-	-
-	-	138-142	125-129	137-141	123-126	n/a	-	-
-	-	142-146	129-133	141-145	127-130	n/a	-	XXXXL

SUITS - STANDARD SIZE CHART (WOMAN) - ON DEMAND

Sizes listed are in cm and are for body measurements, not for the suit.

SIZE	SIZE	SHOULDERS	BREAST	CHEST	WAIST	HIPS	WEIGHT	HEIGHT
XS	38	35-37	78-82	74-78	58-62	82-86	40-45	154-158
	40	36-38	82-86	78-82	62-66	86-90	45-50	157-161
S	42	37-39	86-90	82-86	66-70	90-94	50-55	160-164
	44	38-40	90-94	86-90	70-74	94-98	55-60	163-167
M	46	39-41	94-98	90-94	74-78	98-102	60-65	166-170
	48	40-42	98-102	94-98	78-82	102-106	65-70	168-172
L	50	41-43	102-106	98-102	82-86	106-110	70-75	170-174
	52	42-44	106-110	102-106	86-90	110-114	75-80	173-177
XL	54	43-45	110-114	106-110	90-94	114-118	80-85	176-180
	56	44-46	114-118	110-114	94-98	118-122	85-90	179-183
XXL	58	45-48	118-122	114-118	98-102	122-126	90-95	180-184
	60	46-49	122-126	118-122	102-106	126-130	95-100	182-186

UNDERWEAR - STANDARD SIZE CHART

Sizes listed are in cm and are for body measurements, not for the underwear.

	SIZE					
UI-600 (SLIM FIT)	XS-S	M-L		XL-XXL		
UI-600 RF (REGULAR FIT)	S	M	L	XL	XXL	XXXL
UI-200 (SLIM FIT)	S	M-L		XL-XXL		
CHEST	82-90	90-102	102-114	114-122	122-130	130-138
WAIST	69-77	77-89	89-101	101-109	109-117	117-125
HIPS	81-89	89-101	101-113	113-121	121-129	129-137
HEIGHT	162-166	167-175	176-187	188-193	194-199	n/a
WEIGHT (kg)	43-54	55-72	73-90	91-102	103-114	115-122

SHOES, SOCKS, GLOVES - STANDARD SIZE CHARTS

SHOES				SOCKS
FOOT LENGTH (cm)	EU SIZE	US SIZE	UK SIZE	SIZE
23	36	4	3,5	38/39
23,5	37	5	4	
24	38	6	5	40/41
25	39	6,5	5,5	
25,5	40	7,5	6,5	42/43
26	41	8	7	
27	42	9	8	44/45
27,5	43	10	9	
28	44	10,5	9,5	46
29	45	11,5	10,5	
29,5	46	12	11	
30	47	13	12	
31	48	14	13	



GLOVES		
HAND DIMENSIONS (cm)	SIZE	
20-21	8	XS
21-22	9	S
22-23	10	M
23-24	11	L
24-25	12	XL



SUITS



ABT - Formula E

HERO SUPERLIGHT TS-10

Size	Sandwich weight	FIA	Available SFI	Made in Italy	Available	EXCLUSIVE TECHNICAL SOLUTION MADE IN SABELT
46-66	265 g/m ²	8856-2018	3.2A/5 - 3.4		FRIENDLY	

Top of the range driver suit, made of 100% Nomex®.

Perfect Lightness and Breathability thanks to the 3d honeycomb lining.

All materials exclusively designed by Sabelt in collaboration with the best motorsport teams and drivers.

Hero Superlight TS-10 is Slim Fit made with ultrathin stitching and exclusive bi-stretch panel inserts.

Made In Italy

Technical Details:

- Superlight: 265g/m²
- Slim fit
- Ultrathin stitch
- Bi-stretch elastic panel (Developed by Sabelt)
- Honeycomb lining (Developed by Sabelt)
- Lightweight cuffs (Developed by Sabelt)
- Pre-curved arms
- Full floating sleeves
- Frontal smartphone pocket
- YKK 3T Zipper (Developed by Sabelt)
- Lower neck collar
- FR homologated printing
- Sizes: 46-66
- Homologation: 8856-2018
- Composition: 100% Nomex
- Layers: 3



COLOURS/CODES

	RFTITS10BINR..
	RFTITS10BLAZ..
	RFTITS10NRBI..
	RFTITS10RSBI..
	RFTITS10NRGFL..



MANUFACTURER: SABELT
MODEL: HERO SUPERLIGHT TS-10
HOM. NO: DC.108.20-O
FIA STANDARD: 8856-2018



HERO SUPERLIGHT WOMAN TS-10

Size	Sandwich weight	FIA	Available SFI	Made in Italy	Available	EXCLUSIVE TECHNICAL SOLUTION MADE IN SABELT
38-60	265 g/m ²	8856-2018	3.2A/5 - 3.4		FRIENDLY	

Top of the range driver suit, made of 100% Nomex® developed by women for women. Perfect Lightness and Breathability thanks to the 3d honeycomb lining. All materials exclusively designed by Sabelt in collaboration with the best motorsport teams and drivers. Hero Superlight TS-10 is Slim Fit made with ultrathin stitching and exclusive bi-stretch panel inserts. Made In Italy

Technical Details:

- Superlight: 265g/m²
- Slim fit
- Ultrathin stitch
- Bi-stretch elastic panel (Developed by Sabelt)
- Honeycomb lining (Developed by Sabelt)
- Lightweight cuffs (Developed by Sabelt)
- Pre-curved arms
- Full floating sleeves
- Frontal smartphone pocket
- YKK 3T Zipper (Developed by Sabelt)
- Lower neck collar
- FR homologated printing
- Sizes: 36-60
- Homologation: 8856-2018
- Composition: 100% Nomex
- Layers: 3



COLOURS/CODES	
	RFTUTS10WRFL..
	RFTUTS10WBI..
	RFTUTS10WNR..



MANUFACTURER: SABELT
MODEL: HERO SUPERLIGHT TS-10
HOM. NO: DC.108.20-O
FIA STANDARD: 8856-2018

UNIVERSE TS-8

Size	Sandwich weight	FIA	Available SFI	Made in Italy	Available	EXCLUSIVE TECHNICAL SOLUTION MADE IN SABELT
44-66	310 g/m ²	8856-2018	3.2A/5 - 3.4		FRIENDLY	

Professional driver suit, made of 100% Nomex®. Perfect Lightness and Breathability thanks to the 2 layers construction. All materials exclusively designed by Sabelt in collaboration with the best motorsport teams and drivers. Universe TS-8 is Slim Fit and is made with ultrathin stitching and share the same external fabric of our Hero Superlight TS-10. Made In Italy

Technical Details:

- Superlight: 310g/m²
- Slim fit
- Ultrathin stitch
- Bi-stretch elastic panel (Developed by Sabelt)
- Double lining (Developed by Sabelt)
- Pre-curved arms
- Full floating sleeves
- Lateral Pockets
- YKK 3T Zipper (Developed by Sabelt)
- Lower neck collar
- Embroidered customization
- Sizes: 44-66
- Homologation: 8856-2018
- Composition: 100% Nomex
- Layers: 2



COLOURS/CODES	
	RFTUTS08SFIBL..
	RFTUTS08SFIRS..
	RFTUTS08SFIBL..
	RFTUTS08SFINR..



MANUFACTURER: SABELT
MODEL: TS-8
HOM. NO: DC.279.22-O
FIA STANDARD: 8856-2018

CHALLENGE TS-2

Size	Sandwich weight	FIA	Available SFI	Made in Italy	Available	EXCLUSIVE TECHNICAL SOLUTION MADE IN SABELT
44-66	360 g/m ²	8856-2018	3.2A/5 - 3.4		FRIENDLY	

Professional Driver suit, made of 100% aramidic fiber. Improved lightness and breathability thanks to the two layers construction. All materials exclusively designed by Sabelt in collaboration with the best motorsport teams and drivers. Challenge TS-2 shows the iconic racing square quilting and other technical features appreciated in rally application (full floating sleeves, pockets, belt). Made In Italy

- Technical Details:**
- Weight: 360g/m²
 - Lightweight external layer (Developed by Sabelt)
 - Lightweight cuffs (Developed by Sabelt)
 - Full floating sleeves
 - Pocket
 - Belt
 - YKK 3T Zipper (Developed by Sabelt)
 - Lower neck collar
 - Embroidered logos
 - Sizes: 44-66
 - Homologation: 8856-2018
 - Composition: 100% Aramidic fiber
 - Layers: 2



COLOURS/CODES	
	RFTITS2NR..
	RFTITS2RS..
	RFTITS2BI..
	RFTITS2BL..
	RFTITS2NRGFL..



MANUFACTURER: SABELT
MODEL: CHALLENGE TS-2
HOM. NO: DC.116.21-O
FIA STANDARD: 8856-2018

ROCKET TS-1

Size	Sandwich weight	FIA	Made in Italy	EXCLUSIVE TECHNICAL SOLUTION MADE IN SABELT
S-XXXL	400 g/m ²	8856-2018		

Professional Driver suit, made of 100% aramidic fiber. Improved lightness and breathability thanks to the two layers construction. Spirit TS-1 is an entry level suit but is with high-range features like: bi-color construction, elastic panel, belt, lateral pockets and full floating sleeves.

- Technical Details:**
- Weight: 400g/m²
 - Full floating sleeves
 - Elastic panel
 - Pocket
 - Belt
 - Lower neck collar
 - Embroidered logos
 - Sizes: S-XXXL
 - Homologation: 8856-2018
 - Composition: 100% Aramidic fiber
 - Layers: 2



COLOURS/CODES	
	RFTUTS1NR..



MANUFACTURER: SABELT
MODEL: TS-1
HOM. NO: DC.227.22-O
FIA STANDARD: 8856-2018

TS-SUBLIMATION

NEW

Size	Sandwich weight	FIA	Made in Italy	 EXCLUSIVE TECHNICAL SOLUTION MADE IN SABELT
44-66	440 g/m ²	8856-2018		

Professional Driver suit, fully customizable.

All materials exclusively designed by Sabelt to ensure performance and style. **TS-SUBLIMATION** is fully customizable thanks to the sublimation printing on external fabric.

Technical Details:

- Superlight: 440 g/m²
- Slim fit
- Ultrathin stitch
- Bi-stretch elastic panel (Developed by Sabelt)
- Pre-curved arms
- Full floating sleeves
- Lateral Pockets
- YKK 3T Zipper (Developed by Sabelt)
- Lower neck collar
- Embroidered customization
- Sizes: 44-66
- Homologation: 8856-2018
- Layers: 2



MANUFACTURER: SABELT
MODEL: TS-SUBLIMATION
HOM. NO: DC.346.23-O
FIA STANDARD: 8856-2018

CHOOSE YOUR STYLE WITH NO LIMITS



F•U•L•L•Y C•U•S•T•O•M•I•Z•A•B•L•E

DAKAR TJ-1

NEW

Sabelt fireproof outerwear, designed to meet the needs of rally raid drivers. Thermal comfort during race transfers in cold weather conditions and in the event of rain.

The technology of the materials ensures maximum safety in terms of flame resistance. Thanks to an impermeable membrane, the jacket is completely waterproof and windproof. The outer fabric is fully customizable thanks to the TS-SUBLIMATION technology.

All materials exclusively designed by Sabelt to ensure performance and style.

TS-SUBLIMATION is fully customizable thanks to the sublimation printing on external fabric.

Technical Details:

- Standard fit
- Shoulder handle
- YKK 3T zipper
- Composition: 25% polyester 75% Nomex
- Sizes : XS-XXL
- Internal hidden chest pocket
- Lateral pockets
- fireproof
- Waterproof
- Windproof





HRT Technology - FIA Cross Country Rally World Cup

SHOES



MP Racing – Ferrari Challenge

ZERO GRAVITY TB-11

Size	FIA	Made in Italy	 EXCLUSIVE TECHNICAL SOLUTION MADE IN SABELT
36-48	8856-2018		

Top of the range professional shoe made of fabric.

Extremely lightweight and super breathable thanks to the Nomex® textile upper and 3d honeycomb lining developed by Sabelt.

Top Feeling with the pedals given by super thin outer sole and strobel construction.

Removable insole made of real carbon laminated in autoclave for a perfect distribution of pedal load.

Zero Gravity is not only a name, it's a fact.

Made In Italy.

Technical Details:

- Upper: Superlight 100% nomex fabric, Leather reinforcement
- Lining: Breathable honeycomb 3d
- Outersole: 100% natural rubber
- Closure system: aramidic laces
- Padded ankle and tongue
- Removable insole with carbon reinforcement
- Printed logos
- Sizes: 36-48
- Homologation: 8856-2018





COLOURS/CODES

	RFTB11NR..
---------------------------------------------------------------------------------------	------------



MANUFACTURER: SABELT
MODEL: TB-11
HOM. NO: DC.219.22-Z
FIA STANDARD: 8856-2018

HERO PRO TB-10.1

Size	FIA	Made in Italy	 EXCLUSIVE TECHNICAL SOLUTION MADE IN SABELT
36-48	8856-2018		

Top of the range racing shoes made of kangaroo leather. Lightweight and comfortable thanks to the superthin kangaroo leather and very breathable with the 3d honeycomb lining developed by Sabelt. Super flexible for the strobel construction, Hero Pro TB-10 offers the top of pedal sensibility with its NEW ultra flat outsole. Removable insole is very flexible and is made of real carbon fiber laminated in autoclave. Anti-abrasion reinforcements are placed in dedicated areas. Made In Italy.

Technical Details:

- Upper: Ultrathin & perforated kangaroo leather
- Lining: Breathable honeycomb 3d
- Outersole: 100% natural rubber
- External reinforcement
- Closure system: aramidic laces
- Padded ankle and tongue
- Removable insole in carbon
- Printed logos
- Sizes: 36-48
- Homologation: 8856-2018



UNIVERSE TB-8





Size	FIA	Available SFI	Made in Italy	 EXCLUSIVE TECHNICAL SOLUTION MADE IN SABELT
36-48	8856-2018	3.3/5		

Professional racing shoes made of strong calf leather. Lightweight and comfortable thanks to the calf leather and very breathable with the 3d honeycomb lining developed by Sabelt. It's long lasting, durable shoes for your racing career. Traditional construction is combined with new generation materials. Removable insole is very flexible and comfortable. Anti abrasion reinforcements are placed in dedicated areas. Made In Italy.

Technical Details:

- Upper: Ultrastrong calf leather
- Lining: Breathable honeycomb 3d
- Outersole: 100% natural rubber
- External reinforcement
- Closure system: aramidic laces
- Padded ankle and tongue
- Removable insole
- Printed logos
- Sizes: 36-48
- Homologation: 8856-2018



COLOURS/CODES	
	RFTB101NR..
	RFTB101RS..
	RFTB101BL..
	RFTB101BI..





OPTIONAL



RCTB101SOL..
Reinforced carbon insole





MANUFACTURER: SABELT
 MODEL: HERO PRO TB-10
 HOM. NO: DC.098.20-Z
 FIA STANDARD: 8856-2018

COLOURS/CODES	
	RFTB8NR..
	RFTB8RS..
	RFTB8BI..



MANUFACTURER: SABELT
 MODEL: TB-8
 HOM. NO: DC.272.22-Z
 FIA STANDARD: 8856-2018

CLASSIC TB-2



Size	FIA	Made in Italy	 EXCLUSIVE TECHNICAL SOLUTION MADE IN SABELT
36-46	8856-2018		

Professional driver racing shoe made of soft suede leather. Comfortable and breathable with the 3d honeycomb lining developed by Sabelt. Classic TB-2 is the iconic Sabelt shoe, well known all around the world for its classic design appreciated also in everyday use. Made In Italy.

Technical Details:

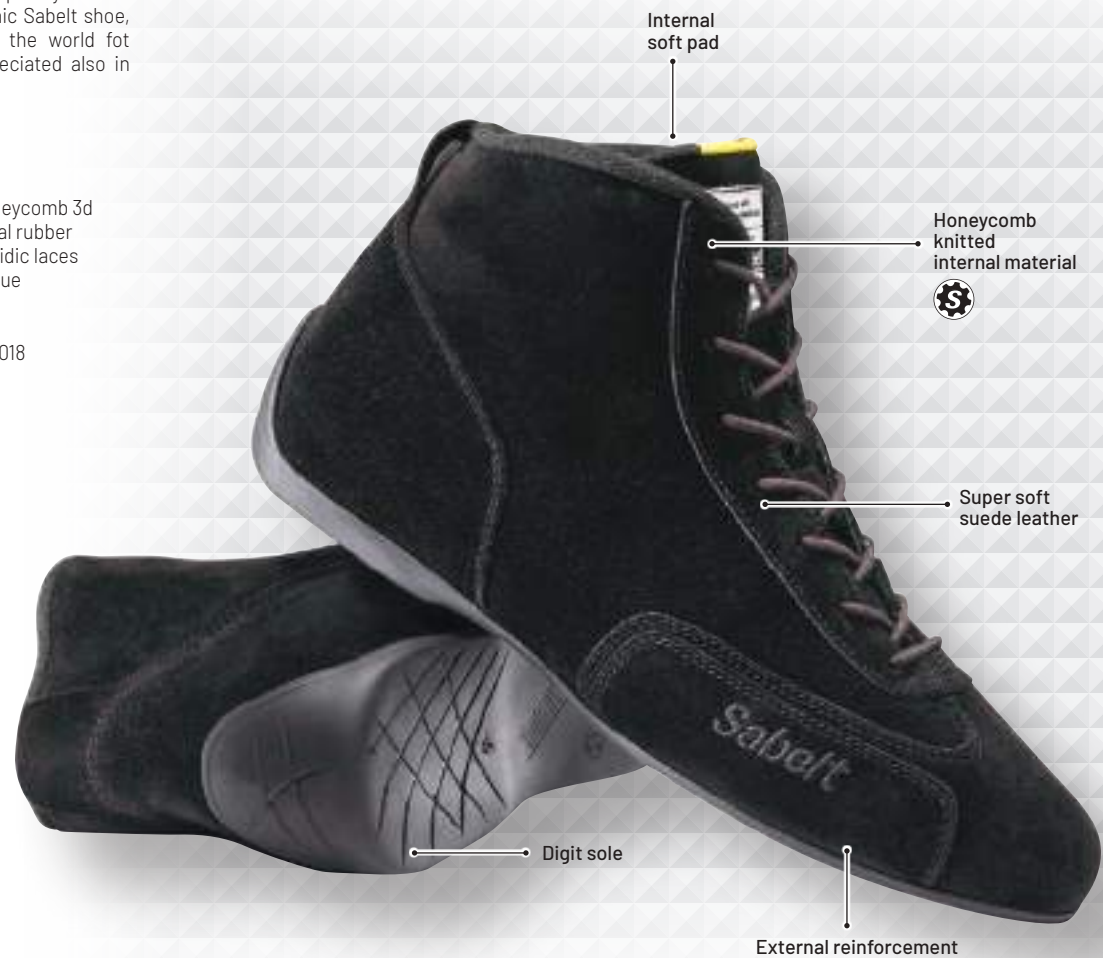
- Upper: Suede leather
- Lining: Breathable honeycomb 3d
- Outersole: 100% natural rubber
- Closure system: aramidic laces
- Padded ankle and tongue
- Printed logos
- Sizes: 36-48
- Homologation: 8856-2018



COLOURS/CODES	
	RFTB02CLASSICNR..
	RFTB02CLASSICRS..



APPROVED
 MANUFACTURER: SABELT
 MODEL: TB-2
 HOM. NO: DC.118.21-Z
 FIA STANDARD: 8856-2018

GLOVES



Ferrari AF Corse – LMH WEC

GECKOTECH TG-11

NEW

Size	FIA	Made in Italy
8-12	8856-2018	



The new Geckotech TG-11 has been developed with new high performance injection silicone palm to ensure maximum grip on the steering wheel and a new breathable fabric for the best driving comfort.

Technical Details:

- Palm: injection silicone
- Breathable external layers
- External Stitching
- Elasticated wrist
- Pre-curved ergonomic design
- Printed logos
- Sizes: 8-12
- Homologation: 8856-2018



COLOURS/CODES

	RFTG11NR..
	RFTG11RS..
	RFTG11BI..



MANUFACTURER: SABELT
MODEL: GECKOTECH TG-11
HOM. NO: DC.370.23-G
FIA STANDARD: 8856-2018



HERO SUPERLIGHT TG-10

Size	FIA	Made in Italy
8-12	8856-2018	

Hero Superlight TG-10 is the Sabelt Top of the range Glove developed for the most demanding professional drivers in motorsport.

Its strength is the ergonomic side with a perfect fitting and steering wheel feeling.

External stitching to improve driver sensibility and a special silicone print for the maximum grip.

Hero Superlight TG-10 includes also specific palm pad and elasticated wrist. Made In Italy.

Technical Details:

- Back: single layer
- Palm: superthin
- External Stitching
- Silicone palm print for grip
- Palm internal pad for comfort
- Elasticated wrist
- Pre-curved ergonomic design
- Printed logos
- Sizes: 8-12
- Homologation: 8856-2018



COLOURS/CODES	
	RFTG10NR..
	RFTG10RS..
	RFTG10BL..
	RFTG10BI..
	RFTG10FL..



CHALLENGE TG-2.1

Size	FIA	Made in Italy
8-12	8856-2018	

Challenge TG-2 is the professional driver glove with suede leather palm. Its strengths are: simple design and strong resistance.

Precurved fingers, internal stitching and printed design are other important elements of this Sabelt glove.

Made In Italy.

Technical Details:

- Precurved design
- Back and Palm made of resistant aramidic fiber
- Internal Stitching
- Palm with suede leather insert for grip
- Printed logos
- Sizes: 9-12
- Homologation: 8856-2018



COLOURS/CODES	
	RFTG21NR..
	RFTG21RS..
	RFTG21BL..



UNDERWEAR



Signatech Alpine – LMP2 WEC

UI-600

FIA
8856-2018

EXCLUSIVE TECHNICAL
SOLUTION
MADE IN SABELT

UNIQUE MATERIAL FOR
SEAMLESS TECHNOLOGY

UI-600 Top

UI-600 Top is the Sabelt top of the range top underwear. Developed with seamless technology and slim fit. This underwear is used and appreciated by the most important Sabelt drivers for its lightness: it's the must have underwear in the paddock thanks to its features. Made In Italy.

Details:

- Lightweight material
- Construction: Seamless
- Fit: slim fit
- Printed logo
- Homologation: 8856-2018

UI-600 Pant

UI-600 Pant is the Sabelt top of the range bottom underwear. Slim fit and developed with seamless technology. Made in Italy.

Details:

- Lightweight material
- Construction: Seamless
- Fit: slim fit
- Printed logo
- Homologation: 8856-2018

UI-600 Balaclava

UI-600 Balaclava is the Sabelt top of the range balaclava underwear. Developed with the same material of the UI-600 Top and Pants but with a specific construction dedicated to increase driver comfort. This Balaclava offers two lateral stitches to reduce the helmet pressure. Made in Italy.

Details:

- Lightweight material
- Lateral Stitching
- Improved wearability
- Printed logo
- Homologation: 8856-2018

UI-600 Socks

UI-600 Socks is the Top of the range Sabelt Sock. Developed with the same material usen in Top and Pants but with a gradual compression construction. Hand made frontal stritching in finger area to increase comfort. The under foot area is flat to guarantee the better pedal feeling. Made in Italy.

Details:

- Lightweight material
- Gradual Compression Technology
- Improved wearability
- Hand made frontal stitch
- Flat under foot area for pedal feeling
- Printed logo
- Homologation: 8856-2018



BALACLAVA
<input type="checkbox"/> RFUI600BALBI
<input checked="" type="checkbox"/> RFUI600BALNR
Sizes: ONE SIZE

TOP
<input type="checkbox"/> RFUI600TOPBI..
<input checked="" type="checkbox"/> RFUI600TOPNR..
Sizes: XS-XXL

PANT
<input type="checkbox"/> RFUI600PANTBI..
<input checked="" type="checkbox"/> RFUI600PANTNR..
Sizes: XS-XXL

SOCK
<input type="checkbox"/> Z150UI600SOCKSB..
<input checked="" type="checkbox"/> Z150UI600SOCKSN..
Sizes: 39-46



UI-600 RF

FIA

8856-2018

 EXCLUSIVE TECHNICAL
SOLUTION
MADE IN SABELT

UI-600 RF Top

UI-600 RF Top is the Sabelt top of the range Top underwear in regular fit version.

The regular fit construction is developed to satisfy professional drivers and mechanics who look for more comfort.

Available in white and black colour.

This underwear is used and appreciated by the most important Sabelt drivers for its lightness.

Made in Italy.

Details:

- Lightweight material
- Tailor packaged construction
- Fit: regular fit
- Colours: White - Black
- Printed logo
- Sizes: S-XXL
- Homologation: 8856-2018

UI-600 RF Pant

UI-600 RF Pant is the Sabelt top of the range Bottom underwear in regular fit version.

The regular fit construction is developed to satisfy professional drivers and mechanics who look for more comfort.

Available in white and black colour.

This underwear is used and appreciated by the most important Sabelt drivers for its lightness.

Made in Italy.

Details:

- Lightweight material
- Tailor packaged construction
- Fit: regular fit
- Colours: White - Black
- Printed logo
- Sizes: S-XXL
- Homologation: 8856-2018



TOP
<input type="checkbox"/> RFUI600TOPRFBI..
<input checked="" type="checkbox"/> RFUI600TOPRFNR..
Sizes: S-XXXL

PANT
<input type="checkbox"/> RFUI600PANTRFBI..
<input checked="" type="checkbox"/> RFUI600PANTRFNR..
Sizes: S-XXXL

 MANUFACTURER: SABELT
MODEL: UI-600 RF TOP
HOM. NO: DC.181.21-T
FIA STANDARD: 8856-2018

 MANUFACTURER: SABELT
MODEL: UI-600 RF PANT
HOM. NO: D.182.21-L
FIA STANDARD: 8856-2018

UI-200

FIA

8856-2018

 EXCLUSIVE TECHNICAL
SOLUTION
MADE IN SABELT

UI-200 Top

UI-200 Top is the Sabelt entry Top underwear for professional drivers. Its construction is made with seamless technology in slim fit sizes. Available in optic white and black colour. This underwear is used and appreciated by the most important Sabelt drivers for its lightness. Made in Italy.

Details:

- Lightweight material
- Construction: Seamless
- Fit: slim fit
- Printed logo
- Sizes: XS-XXL
- Homologation: 8856-2018

UI-200 Pant

UI-200 Pant is the Sabelt entry Bottom underwear for professional drivers. Its construction is made with seamless technology in slim fit sizes. Available in optic white and black colour. This underwear is used and appreciated by the most important Sabelt drivers for its lightness. Made in Italy.

Details:

- Lightweight material
- Construction: Seamless
- Fit: slim fit
- Printed logo
- Sizes: XS-XXL
- Homologation: 8856-2018

UI-200 Balaclava

UI-200 Balaclava is the Sabelt entry Balaclava underwear for professional drivers. Developed with the same material of the UI-200 Top and Pants but with a specific construction developed to increase driver comfort. This Balaclava offers a central stitch on top and a wide front opening. Available in optic white and black colour. This underwear is used and appreciated by the most important Sabelt drivers for its lightness. Made in Italy.

Details:

- Lightweight material
- Central stitch on top
- Increased wearability
- Printed logo
- Sizes: one size
- Homologation: 8856-2018



BALACLAVA
<input type="checkbox"/> RFUI200BALBI
<input checked="" type="checkbox"/> RFUI200BALNR
Sizes: ONE SIZE

TOP
<input type="checkbox"/> RFUI200TOPBI..
<input checked="" type="checkbox"/> RFUI200TOPNR..
Sizes: XS-XXL

PANT
<input type="checkbox"/> RFUI200PANTBI..
<input checked="" type="checkbox"/> RFUI200PANTNR..
Sizes: XS-XXL

 MANUFACTURER: SABELT
MODEL: UI-200 BALACLAVA
HOM. NO: DC.241.22-B
FIA STANDARD: 8856-2018

 MANUFACTURER: SABELT
MODEL: UI-200 TOP
HOM. NO: DC.239.22-T
FIA STANDARD: 8856-2018

 MANUFACTURER: SABELT
MODEL: UI-200 PANT
HOM. NO: DC.240.22-L
FIA STANDARD: 8856-2018

UI-300 PERSONAL UNDERWEAR

FIA	EXCLUSIVE TECHNICAL SOLUTION MADE IN SABELT	SEAMLESS CONSTRUCTION COMPOSITION WITH NATURAL FIBERS
8856-2018		

! Personal underwear is not mandatory to be worn during racing events.

FIA approved PU is mandatory when it is worn by drivers.

UI-300

Boxer man, Bra woman, Slip woman

All the Personal Underwear products are made with high percentage of natural fibers in order to guarantee a natural feeling to the drivers' skin.



BOXER (man)
RFUI300BOXNR..
Sizes: XS/S - M/L - XL - XXL

SLIP (woman)
RFUI300SLIPNR..
Sizes: XS/S - M/L - XL - XXL

BRA
RFUI300BRANR..
Sizes: XS/S - M/L - XL - XXL

FIA APPROVED
 MANUFACTURER: SABELT
 MODEL: UI-300 SHORTS
 HOM. NO: DC.368.23-W
 FIA STANDARD: 8856-2018

FIA APPROVED
 MANUFACTURER: SABELT
 MODEL: UI-300 SLIP
 HOM. NO: DC.367.23-W
 FIA STANDARD: 8856-2018

FIA APPROVED
 MANUFACTURER: SABELT
 MODEL: UI-300 BRA
 HOM. NO: DC.366.23-W
 FIA STANDARD: 8856-2018



ABT - Formula E

CREW



Ferrari AF Corse - LMH WEC

ARMOR TM-2

NEW

Size	Sandwich weight	SFI	Made in Italy	Colour/Code	 EXCLUSIVE TECHNICAL SOLUTION MADE IN SABELT
XXS-XXXXL	360 g/m ²	3.2A/5 - 3.4		 RFTUTM2NR..	

AMERICAN FITTING

Professional 2 Pieces Mechanic suit, made of 100% aramid fiber. Improved lightness and breathability thanks to the two layers construction. All materials exclusively designed by Sabelt in collaboration with the best motorsport teams and drivers. Armour TM-2 shows the iconic racing square quilting and other technical features appreciated in rally application (full floating sleeves, pockets, belt). Made In Italy.

Technical Details:

- Weight: 360g/m²
- Lightweight external layer (Developed by Sabelt)
- Composed by 2 pieces, jacket and bottom
- Mechanic feature
- Full floating sleeves
- Pocket
- Belt
- YKK 3T Zipper (Developed by Sabelt)
- Embroidered logos
- Sizes: XXS-XXXXL
- Homologation: 8856-2018
- Composition: 100% Aramidic fiber
- Layers: 2



ROCKET TM-1

Size	Sandwich weight	Hom.	Made in Italy	Colour/Code	EXCLUSIVE TECHNICAL SOLUTION MADE IN SABELT
S-XXXL	400 g/m ²	n/a		 RFTUTMINR..	

Professional Crew Suit made of Polyester / Cotton. Improved lightness and breathability thanks to the perforated lining. The Rocket TM-1 is a very resistant mechanic suit designed with the same family feeling of the Sabelt racing suit. Full floating sleeves, lateral pockets, belt and embroidered logos are some of interesting details of this product.

Technical Details:

- Composition: Polyester / Cotton
- Full floating sleeves
- Breathable perforated lining
- Waist internal elastic tape
- Pocket
- Belt
- Lower neck collar
- Embroidered logos
- Sizes: S-XXXL
- Homologation: N/A
- Layers: 2



LASER TB-3

Size	FIA	Made in Italy	Available	EXCLUSIVE TECHNICAL SOLUTION MADE IN SABELT
36-48	8856-2018		 FRIENDLY	

Shoes created for professional drivers and crew, made of perforated calf leather.

Very breathable with the 3d honeycomb lining developed by Sabelt.

Laser TB-3 is a modern sneaker Fia homologated developed for drivers and crew members that look for a different style.

It's the Different choice!



The outersole with shock absorber is recommended to many hours of activity.

Made In Italy.

Technical Details:

- Upper: Perforated calf leather
- Lining: Breathable honeycomb 3d
- Outersole: 100% natural rubber
- Shock absorber material
- Closure system: aramidic laces & strap
- Padded ankle and tongue
- Gusseted tongue
- Reinforced toe-cap
- Removable insole
- Printed logos
- Sizes: 36-48
- Homologation: 8856-2018



COLOURS/CODES	
	RFTB03LASERNR..
	RFTB03LASERBI..



MANUFACTURER: SABELT
MODEL: LASER TB-3
HOM. NO: DC.115.21-Z
FIA STANDARD: 8856-2018

LASER TG-3.1

Size	FIA	Made in Italy	Available	 EXCLUSIVE TECHNICAL SOLUTION MADE IN SABELT
9-13	8856-2018		 FRIENDLY	

Laser TG-3 is the Sabell top of the range Mechanic glove developed with the crew members of most important teams in WEC discipline and Fia homologated.

This model has many technical details as the anti-impact knuckles pad. Total padded wrist strap that protect the crew during the rapid tires change. Super grip suede leather apprication into the palm to increased heat protection and a specific silicone area for the wheel gun operations. Made In Italy.

Technical Details:

- Back: single layer
- Palm: Superthin
- Internal Stitching
- Suede leather palm insert for heat protection
- Silicone Wheel gun protection
- Knuckles protection
- Padded wrist strap
- Precurved design
- Printed logos
- Sizes: 9-13
- Homologation: 8856-2018



COLOURS/CODES	
	RFTG31NR..
	RFTG31GFL..



MANUFACTURER: SABELT
MODEL: LASER TG-3
HOM. NO: DC.122.21-G
FIA STANDARD: 8856-2018



STEERING WHEELS

Sabelt



SW-833
 Ø 330 mm

CODE	RFV02029
30% LIGHTER	



SW-633
 Ø 330 mm

CODE	RFV02010X
NO STITCHING	



SW-465
 Ø 350 mm

CODE	RFV02009X
NO STITCHING	



SW-732
 Ø 320 mm

CODE	RFV02038
NO STITCHING	



SW-733
 Ø 330 mm

CODE	RFV02026
NO STITCHING	



SW-635
 Ø 350 mm

CODE	RFV02007X
NO STITCHING	



SW-390
 Ø 350 mm

CODE	RFV02005X
NO STITCHING	



ACCESSORIES



Firenze Race Team

QUICK RELEASE



M220SR6GRN
Quick release steering boss for group N cars, conformity to FIA regulation, compatible with all Sabelt 6-slot steering wheels.



M220SR6B
Quick release steering boss to be welded for Touring/Rally cars, conformity to FIA regulation, compatible with all Sabelt 6-slot steering wheels.

STEERING WHEEL PROTECTION PAD

NEW



RCVOPAD001
Protection pad with 3 velcro loops to attach to any racing steering wheel. CONFOR™ foam CF45M (blu) compatible with FIA Appendix J Article 285 (August 2020).

TOW STRAP

Length: 260 mm.
Hole diameter: 15,5 mm.



CCAC0023_A

CCAC0027_A

CCAC0024_A

CCAC0028_A

CCAC0026_A

CCAC0025_A

DOOR STRAP



CCAC0043_A
Door strap to be fixed on the door panel. Length: 220 mm. Hole diameter: 9.5 mm.

NOTEBOOK



Z240600
Size 22 x 17,5 cm

CO-DRIVER POCKET

Nomex fabric.
Velcro locking.
Size 17 x 23 cm.



RFTINAVRS RFTINAVBR RFTINAVBI RFTINAVNR

CO-DRIVER BAG

Co-Driver bag, very thin. Velcro back panel for door bars universal fixation, phone compartment and external pockets.



COLOURS/CODES		
	RFBS0039	27x36x7 cm

WEEKEND BAG



COLOURS/CODES		
	RFBS0016NR	55x37x23 cm
	RFBS0016RS	

SUIT BAG



COLOURS/CODES		
	RFBS0015	46x34x10 cm

K-WAY



COLOURS/CODES		Sizes
	RSPW014BL...	XS-XXL

