



HELMETS
2024 CATALOG

RACINGFORCEGROUP



X00-881-2024-BELL-P
 CATALOG BELL 2024 - WITH
 PRICES

2024 CATALOG



HELMETS



HELMETS

2024 CATALOG





A BRAND OF

RACING
FORCE
GROUP



Discover all Racing Force Group products

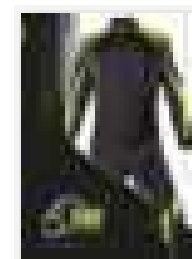

OMP racewear
2024 catalog

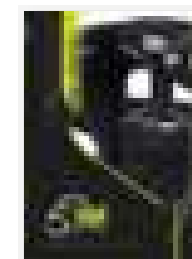

OMP car parts
2024 catalog

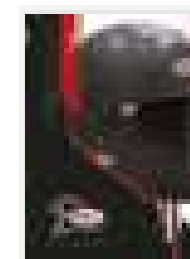

BELL helmets
2024 catalog



Racing Spirit
2024 catalog



SAFETY & QUALITY FOR FIA

SIDE BY SIDE SINCE 2012



FIA Motorsport



For over a decade Racing Force Group and FIA have been committed side by side on roads and racetracks to guarantee the protection of the people of racing. This story began in 2012 with the first agreement between OMP and the motorsport's world governing body, and it developed into something even bigger as Bell Racing Helmets became involved as well in the partnership.

FIA Motorsport



Technical racing clothing for FIA officials and safety car drivers across a range of FIA world championships (from F1 down) comes exclusively from Racing Force Group: OMP fire retardant suits, shoes, gloves and underwear, and Bell helmets.



FIA Karting Academy



Moreover, since 2017 OMP brand has the honor to supply technical racewear to the young contestants FIA Karting Academy Trophy, the forge of tomorrow's motorsport champions.



SEVENTY YEARS OF SERIOUS HEAD PROTECTION

In 2024, Bell Racing Helmets proudly celebrates its 70th anniversary. Now part of Racing Force Group, the brand is the world's leading manufacturer of state-of-the-art automobile and karting racing helmets designed for professional and amateur drivers.

The Bell name is synonymous with safety, innovation, performance and engineering excellence. Since 1954, when the company was founded in a suburb of Los Angeles, California, Bell helmets have been worn and trusted by legendary names in all forms of racing, including Formula 1, NASCAR, IndyCar and the World Rally Championship.

Bell's reputation has been enhanced over time by several innovations, pioneering solutions and new standards that have helped drivers not only be better protected, but also to perform better.

Bell Racing Helmets remains committed to working with the world's best drivers and organizations to progress helmet technology, with an endless willingness of being the premier choice in the industry.





SERIOUS HEAD PROTECTION

CONSTANT EVOLUTION

BELL HELMETS HISTORY

70 years of innovation in the world's most demanding sport

It Takes A Lot to Finish First

To get there, you need an amazing combination of cutting-edge technology, seamless teamwork, proven skill, dedication and unwavering nerve. It also takes a good deal of precaution.

As a company of first, Bell has never stopped the pursuit of serious head protection through innovation and a focus on the future. We were the first company to be Snell certified, introduce an energy absorbing liner system, build a full-face helmet, fire retardant helmet, aerodynamic helmet, anti-fog shield and homologate an FIA 8860 "super helmet".

That same forward thinking defines everything we do and is exhibited in every high-performance racing helmet we build. Delivering the ultimate in protection, innovation, technology and reliability, it's no wonder why more champions have proudly worn Bell Helmets than any other brand.

Time Tested, Champions Trusted

For over 65 years, our commitment to innovative design and progressive approach to safety has defined Bell Racing.

That same attention to detail continues today throughout our entire line of products making each Bell helmet unique and worthy of being worn by the world's best drivers. The latest generation of Bell Racing helmets offer forward-thinking design, leading-edge technology, superior engineering, outstanding comfort and fit, enhanced ventilation and industry leading features with the latest material innovations and manufacturing techniques to create the most advanced line of racing helmets available in the world today.

PROVEN SINCE 1954

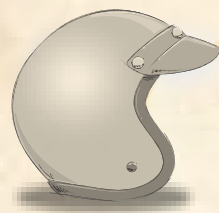

1954

MANUFACTURING BEGINS

Bell begins manufacturing its first helmet. (the '500') in a garage located behind Bell Auto Parts.

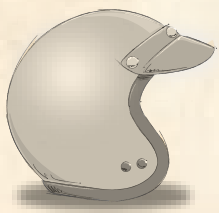

1957

500-TX

500-TX, the first motorsports helmet to use an energy absorbing EPS liner system.

Jimmy Bryan won the 1958 Indy 500 wearing the 500-TX, Bell's first Indianapolis 500 win.

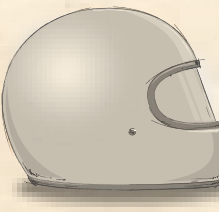

1966

STAR

Bell introduces the world's first full-face helmet (the Star).

Dan Gurney was the first driver to use the Bell Star in auto racing competition in 1968.

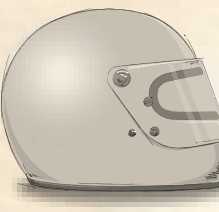

1973

STAR FX

Bell introduces the Star FX, the first fire retardant auto racing helmet.

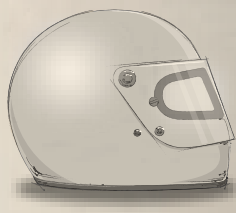

1978

STAR FX STAR XF DUAL EYEPORT

The first dual eyeport helmet, Star XF is introduced.

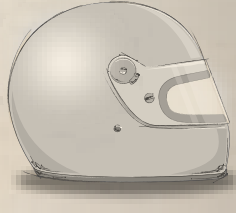

1979

XFM-1

The XFM-1 was the first lightweight composite auto racing helmet. It became the helmet of choice for open-wheel drivers everywhere.

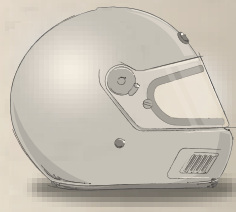

1991

AFX-1

The AFX-1 was the first all Kevlar helmet and the first to feature a ventilation system that incorporated chin bar vents and top vents to create airflow through the helmet.

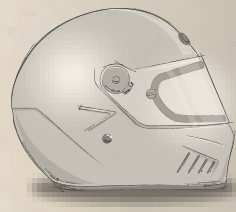

1992

VORTEX

This is the first ever helmet with aerodynamic elements including trip strips and vortex generators to reduce helmet buffeting in open-wheel environments.

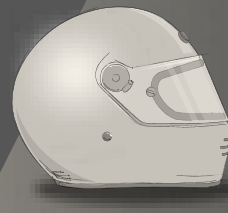

1993

M3

The M3, a multi-use lightweight helmet combined classic Bell features with bold European styling to create a universal design that could be used world-wide in all forms of racing.

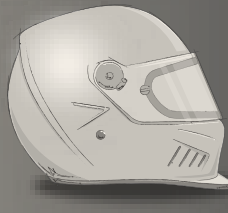

1993

FEULING SS

The first aerodynamic helmet for speeds well over 320 kph, Feuling SS featured a front lip and rear wicker that reduced lift and buffeting. Feuling SS first used in 1993 at the Indy 500.

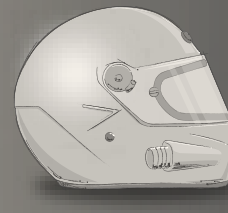

1996

VORTEX TURBO AIR

The Vortex Turbo Air was the first auto racing helmet to feature internal high-speed fans that directed airflow to the face and the shield for comfort and to prevent shield fogging.

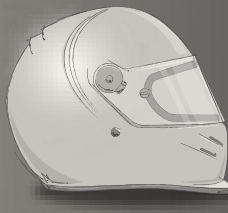

1997

DOMINATOR

The Dominator is introduced, the first helmet with gurneys built into the shell for enhanced aerodynamic performance in a compact design.

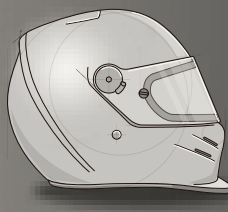

1998

FEULING II

Bell introduces the Feuling II, a redesigned version of the Feuling SS to fit new advanced headrests designed for open wheel racing, featuring a smaller profile and aerodynamic signature.

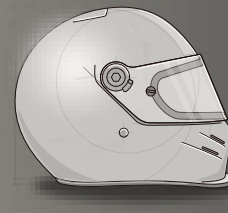

1999

KF1

The KF1 is the first helmet to feature full integration of the edge of the shield into the helmet shell for improved aerodynamic performance.

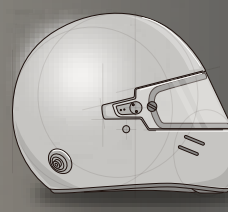

2004

HP1

Bell's HP1 is the first helmet to be homologated to the FIA8860 advanced helmet standard and used in F1 competition.

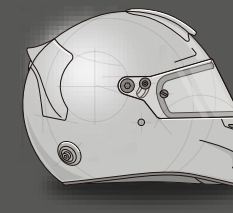

2007

HP3

This model features an ultra-lightweight carbon shell and advanced energy-absorbing liner. A front lip provides aerodynamic stability and air vents maximise airflow inside.

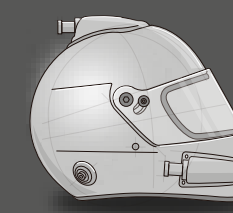

2010

BR1

Bell's BR1 is the first forced air helmet design for use in either a side or top air configuration using a kit system.

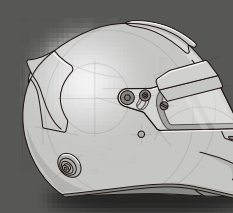

2011

HP3 Visor Panel

Bell is the first company to homologate and use a Zylon Visor Panel in F1 competition

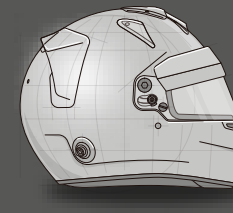

2014

HP7

Bell introduces the HP7 featuring an innovative shell and integrated shield design, moving the pivot locations down and forward to improve acoustic and aerodynamic performance while enhancing energy management capacities.

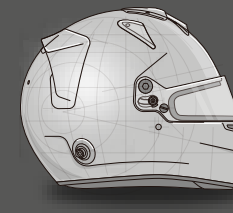

2019

HP77

Bell introduces the HP77, the first helmet in the world featuring a ballistic reinforcement incorporated into the shell and replacing the visor panel.

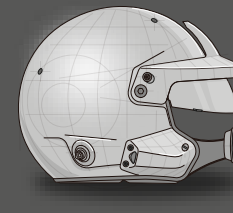

2021

HP10 RALLY

After 2 years of intense Research & Development with the best drivers and best teams, Bell comes back in World Rally Championship, setting new levels of comfort, performance and acoustic qualities thanks to ZeroNoise™ electronics.



SERIOUS HEAD PROTECTION

#ChampionsWearBell



F1 CHAMPIONS BELL HISTORY



BELL 1954 HERITAGE CLUB

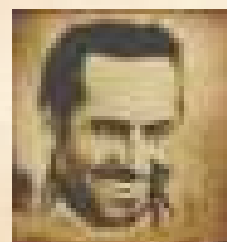

F1 World Champions wearing Bell Helmets

1959
1960

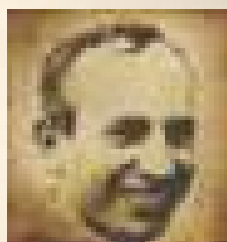

JACK BRABHAM

1964

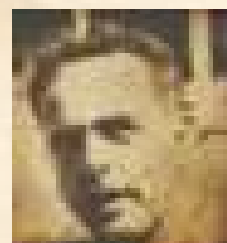

JOHN SURTEES

1961

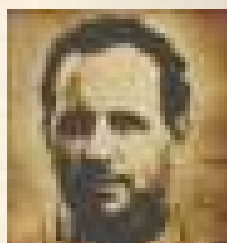

PHIL HILL

1967

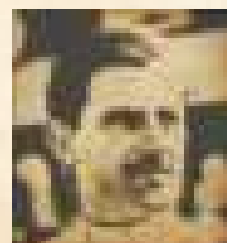

DENNY HULME

1962
1968

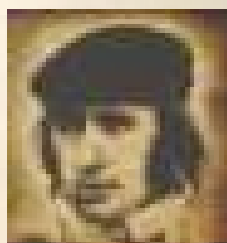

GRAHAM HILL

1969
1971
1973

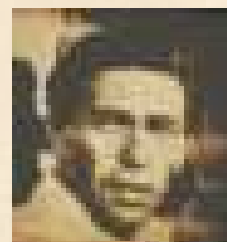

JACKIE STEWART

1963
1965

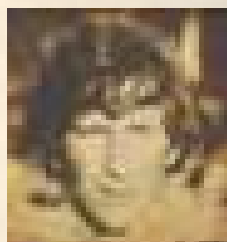

JIM CLARK

1970

JOCHEN RINDT

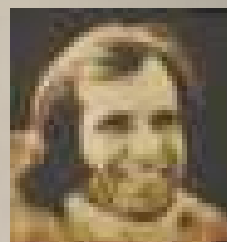

1972
1974

EMERSON FITTIPALDI

1972
1974

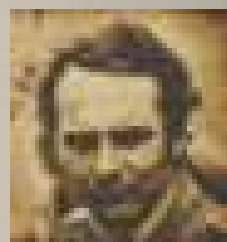

1975
1977
1984

NIKI LAUDA

1975
1977
1984

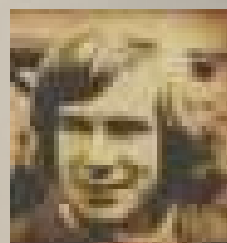

1976

JAMES HUNT

1976

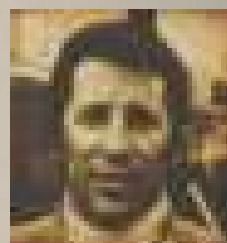

1978

MARIO ANDRETTI

1978

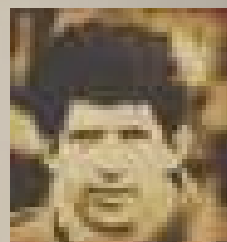

1979

JODY SCHECKTER

1979

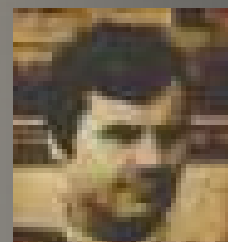

1980

ALAN JONES

1980

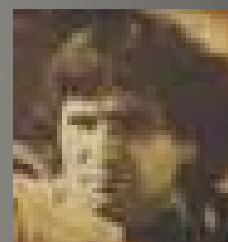

1981
1983
1987

NELSON PIQUET

1981
1983
1987

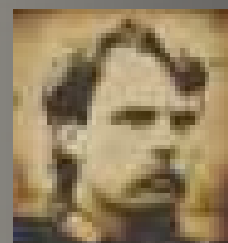

1982

KEKE ROSBERG

1982

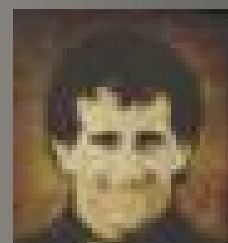

1985
1986, 1989
1993

ALAIN PROST

1985
1986, 1989
1993

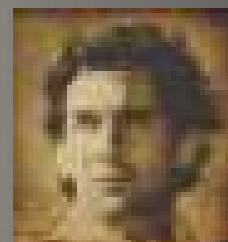

1988
1990
1991

AYRTON SENNA

1988
1990
1991

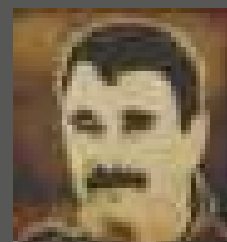

1992

NIGEL MANSELL

1992

1994
1995, 2000
2001, 2002
2003, 2004

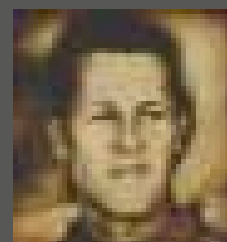
MICHAEL SCHUMACHER

1994
1995, 2000
2001, 2002
2003, 2004

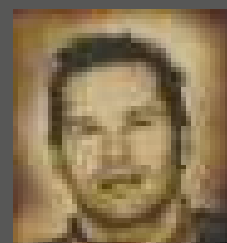
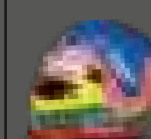

1997

JACQUES VILLENEUVE

1997

1998
1999

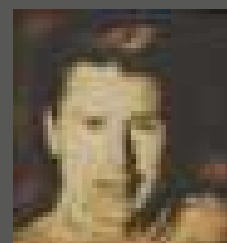
MIKA HÄKKINEN

1998
1999

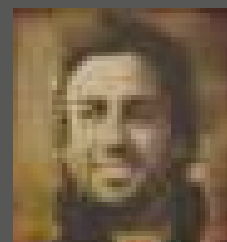
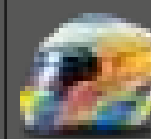

2005
2006

FERNANDO ALONSO

2005
2006

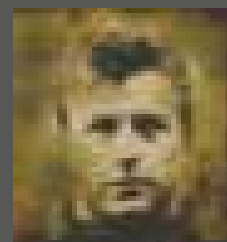

2007

KIMI RÄIKKÖNEN

2007

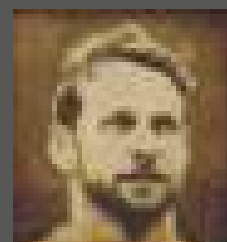

2009

JENSON BUTTON

2009

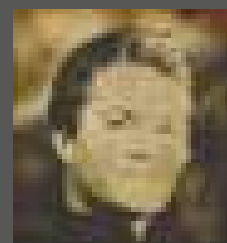

2016

NICO ROSBERG

2016

2020

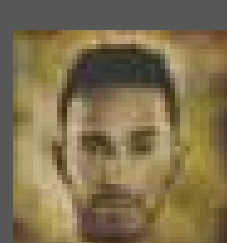
LEWIS HAMILTON

2008, 2014
2015, 2017
2018, 2019
2020



SERIOUS HEAD PROTECTION

#AnySurfaceAnySpeed

INDEX



FERRARI
TECHNICAL
PARTNER

HELMETS



CIRCUIT
FULL FACE

PAGE 07



RALLY

PAGE 27



CIRCUIT
OPEN FACE

PAGE 41



KARTING

PAGE 51



CLASSIC

PAGE 69

ACCESSORIES INDEX

PAGE 75

ADVANCED



CARBON

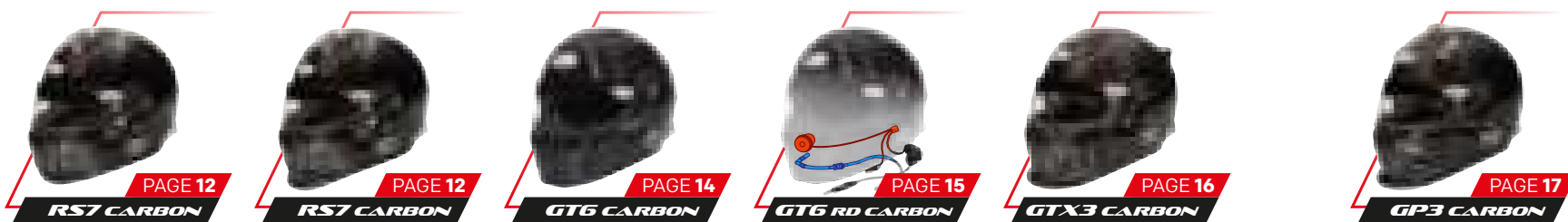

PRO



SPORT



At Bell, we know racing and we know it is a serious business. For CIRCUIT racing, we offer a complete line of FULL FACE helmets, from the Advanced HP77 chosen by a majority of Formula One drivers to the GT5 Sport, the helmet of choice for occasional racers.

Some models are declined in various versions:

- The Advanced Series helmets (HP) use ultra-lightweight aerospace grade carbon shell combined with a high-performance multi-density energy absorbing liner system delivering the ultimate protection. They are the pinnacle of technology and innovation, representing the best of Bell.
- The Carbon Series helmets feature a lightweight carbon shell and deliver the best performance to value ratio in motorsport.
- The Pro Series helmets, with their lightweight composite shell, are designed for drivers at all levels of racing who expect industry-leading performance, professional features and the latest engineering advances.
- The Sport Series helmets are intended for amateur racers who do not want to compromise on safety and comfort.



* Driver's Eye™ is the world's first and only FIA homologated micro camera system to be integrated into a racing helmet. Driver's Eye™ is a patented technology of Zeronoise that provides the audience with a unique point of view of the driver on the racetrack. Zeronoise is the electronics division of Racing Force Group that designs and manufactures high-end custom technologies.

FULL FACE HELMETS
CIRCUIT

The HP77 is based on Bell's highly successful and multiple F1 World Champion proven HP7 design. Chosen by a majority of top professional open cockpit racers, the HP77 provides the most advanced protection, featuring a very narrow eyeport on top of which high strength ballistic materials have been incorporated. Following a long tradition of innovation, the HP77 was the first helmet to meet the latest FIA8860-2018-ABP standard. It is renowned for its lightweight, aerodynamic qualities, superior cooling and amazing defogging system for the intense demands of open-cockpit forms of racing in all types of weather. The HP77 is homologated to the FIA8860-2018 ABP standard, the most rigorous sport helmet standard on the planet, designed for professional formula racers competing at the highest levels of the sport.

- Full face helmet featuring High-strength and High-modulus carbon fibres ultra-lightweight FIA8860-2018 ABP shell
- Very narrow eyeport
- Frontal area with integrated ballistic materials for added protection from flying debris
- Advanced multi-density, multi-piece liner to maximize energy absorption and impact performance
- Optical grade injected Double Screen Anti-Fog (DSAF) shield for anti-fog control and superior visibility
- Powerful and effective top and chin bar ventilation system with 12 air intake and extraction channels for maximum ventilation
- Air intake system includes two part centre and low profile on sides (installed)
- Shell and shield design optimized to improve aerodynamic performance, reduce internal noise and enhance energy management capacities
- Integrated channels in face piece offering multiple options to install drink tube and communication systems
- Top spoiler, top and chin bar gurneys available separately
- Factory installed Hans anchors as original equipment
- Synthetic rubber gasket seal to prevent dirt and water from entering the helmet
- Available with frontal chinbar hole for the introduction of the drinking tube (optional special order)
- HP helmet bag included
- Shield and pivot kit: SE077 3MM, SV(SE07)
- Interior: Dark Grey High Strength – High Comfort FR Fabric
- Alternative interior fabric colors: Tan, White, Red, Purple, Blue, Green, Neon Yellow, Pink and Orange (on special order)
- Color: Carbon, Matte finish
- Sizes: 54-55-56-57-58-59+
- Homologation: FIA8860-2018-(ABP)



MANUFACTURER: BELL RACING HELMETS
MODEL: HP77
HOM. NO.: AH.008.19.C-ABP
FIA STANDARD: 8860-2018-ABP



Main accessories on page 13



HP Helmet Bag included

Developed through close collaboration with leading F1 drivers and teams, the carbon fiber HP7 is aerodynamically sleek, lightweight and efficient for the intense demands of all forms of racing. Meeting FIA8860-2018 "Advanced Helmet" standard, the HP7 is also equally popular amongst professional drivers in open-cockpit cars and closed Sports cars and GT cars, thanks to its very high level of comfort. For professional drivers competing in high-speed forms of motorsports, the HP7 allows racers to take advantage of the latest technological innovations including aerospace composite materials and advanced energy absorbing liner systems.

- Full face helmet featuring High-strength and High-modulus carbon fibres ultra-lightweight FIA8860-2018 carbon shell
- Advanced multi-density, multi-piece liner to maximize energy absorption and impact performance
- Optical grade injected Double Screen Anti-Fog (DSAF) shield for anti-fog control and superior visibility
- Powerful and effective top and chin bar ventilation system with 12 air intake and extraction channels for maximum ventilation
- Air intake system includes two part centre and low profile on sides (installed)
- Shell and shield design optimized to improve aerodynamic performance, reduce internal noise and enhance energy management capacities
- Integrated channels in face piece offer multiple options to install drink tube and communication systems
- Top spoiler, top and chin bar gurneys available separately
- Factory installed Hans anchors as original equipment
- Synthetic rubber gasket seal to prevent dirt and water from entering the helmet
- Available with frontal chinbar hole for the introduction of the drinking tube (optional special order)
- HP helmet bag included
- Shield and pivot kit: SE07 3MM, SV(SE07)
- Interior: Dark Grey High Strength – High Comfort FR Fabric
- Alternative interior fabric colors: Tan, White, Red, Purple, Blue, Green, Neon Yellow, Pink and Orange (on special order)
- Color: Carbon, Matte finish
- Sizes: 54-55-56-57-58-59-60-61-61+
- Homologation: FIA8860-2018



HP Helmet Bag included



Main accessories on page 13



MANUFACTURER: BELL RACING HELMETS
MODEL: HP7 EVO-III
HOM. NO.: AH.007.19-C
FIA STANDARD: 8860-2018

THE BEST DRIVERS WEAR BELL HP77

BELL F1 AMBASSADORS



L. Hamilton

C. Sainz

F. Alonso

L. Norris

C. Leclerc

G. Russell

O. Piastri

P. Gasly

E. Ocon

A. Albon

G. Zhou

K. Magnussen

L. Sargeant

Incorporating technology used in our state-of-the-art HP7 Advanced Helmets, the HP6, with its modern and aggressive design, has been developed for racers in closed-car environments, featuring a wide eyeport for extended vision with an ultra-lightweight Advanced carbon shell. Its ventilation slots can be connected to various types of air intakes for external cooling systems. It can be fitted with optional earmuffs providing optimal noise insulation, with fully integrated radio communication kit and hydration systems (available separately or in RD version).

- Ultra-lightweight FIA8860-2018 Advanced full carbon shell
- Wide eyeport opening for optimal vision in closed cockpit cars (Shield type SE06)
- Advanced multi-density, multi-piece liner to maximize energy absorption and impact performance
- Integrated channels in face piece offering multiple options to install drinking tube, valves and radio systems
- Extraction vents to maximize cooling and air circulation
- Factory installed Hans anchors as original equipment
- Optional Top forced air intake can be installed on the left or right top side vents - available for use with and external cooling system
- Forced air kits available for aftermarket including quick lock (V10) and are fully compatible with Maglock
- HP helmet bag included
- Interior: Dark Grey High Strength – High Comfort FR Fabric
- Alternative interior fabric colors: Tan, White, Red, Purple, Blue, Green, Neon Yellow, Pink and Orange (on special order)
- Color: Carbon, Matte finish
- Sizes: 54-55-56-57-58-59-60-61-61+
- Homologation: FIA8860-2018



HP Helmet Bag included



ACCESSORIES AVAILABLE

HP6, HP6 RD, HP6 RALLY, GT6 CARBON, GT6 RD CARBON
GT6 RALLY CARBON, GT6 PRO, GT6 RALLY

INT.PARTS KIT - HP6 RD

208xxxx

Grey

85,00 €



208xxxx

Colored

95,00 €

COVER PLATE/FORCED
AIR LOW PROFILE NOZZLE

2070312
50,00 €



COVER PLATE/FORCED
AIR QL NOZZLE

2070313
50,00 €



Check all the options in the accessories section

- Same characteristics as HP6 with fully integrated radio communication kit and hydration systems.
- ZeroNoise® noise cancelling microphone integrated in face piece
- Coil style (curly cable) with heavy duty In-Molded Male Nexus Connector (4 pins)
- RCA connector compatible with Earplug Transducers (Various types of ZeroNoise® Transducers available as accessory)
- Hydration system (drinking tube) with fast release connector
- Compatible with earmuffs for increased noise insulation

DRINKING TUBE KIT

The integrated drinking tube kit includes flexible tubing, L shaped adaptor to properly position the mouth bite valve and a one-way valve for drinking systems. This allows for seamless integration without modifying the face piece or drilling holes in the helmet chin bar (bite valve and drinking system not included).

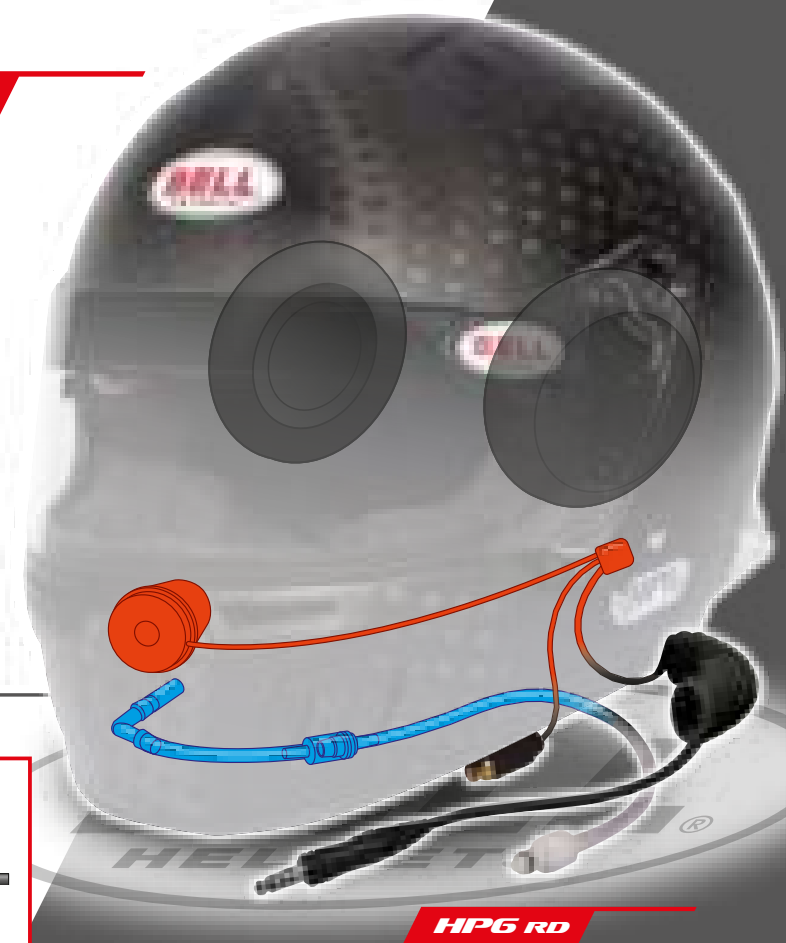

- RCA connector compatible with Earplug Transducers



- 1/8 Hose Barb Valved In-Line Coupling Body fast connector

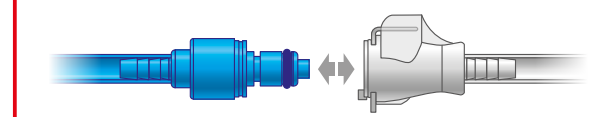

MICROPHONE KIT RCA-CINCH

Bell's 4 connector radio helmet kit features a dynamic noise canceling microphone pre-wired and integrated into the helmet's face piece and optimized to work with industry standard radio systems. The kit includes a coil style cord and ready for use with "in-ear" transducers (ear buds) fitted with RCA-CINCH Female Connector.

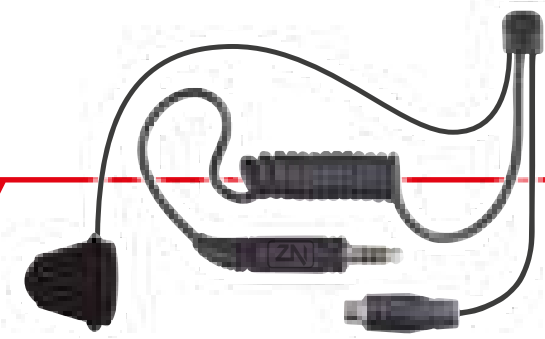

Based on the innovative HP7 design and featuring an ultra-lightweight carbon shell, the RS7 Carbon provides racers with unmatched acoustic comfort, aerodynamic performance and energy absorbing capacities. The sleek, aerodynamic design features an advanced ventilation system with 14 air intake and extraction channels for maximum airflow and ventilation.

- Ultra-lightweight Premium Carbon Composite shell
- Advanced multi-density, multi-piece liner to maximize energy absorption and impact performance
- Optical grade injected Double Screen Anti-Fog (DSAF) visor for anti-fog control and superior visibility
- Powerful and effective top and chin bar ventilation system with 14 air intake and extraction channels for maximum ventilation
- Air intake system includes two-part centre and side air intakes (installed)
- Shell and shield design optimized to improve aerodynamic performance, reduce internal noise and enhance energy management capacities
- Integrated channels in face piece offer multiple options to install drink tube and radio systems
- Rear spoiler, top and chin bar gurneys available separately
- Top air attachments available separately
- Synthetic rubber gasket seal to prevent dirt and water from entering the helmet
- Factory installed Hans anchors as original equipment
- Shield and pivot kit: SE07 3MM, SV(SE07)
- Interior: Dark Grey High Strength – High Comfort FR Fabric
- Alternative interior fabric colors: Tan, White, Red, Purple, Blue, Green, Neon Yellow, Pink and Orange (on special order)
- Available in two versions: with or without duckbill (Chin spoiler)
- Color: Carbon, Gloss finish
- Sizes: 54-55-56-57-58-59-60-61-61+
- Homologation: FIA8859-2015 & SNELL SA2020

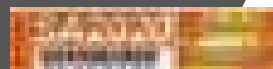

MANUFACTURER: BELL RACING HELMETS
MODEL: RS7 CARBON-20
HOM. NO: PH.083.20-C
FIA STANDARD: 8859-2015



REAR SPOILER
2050032 to 2050034
Small, Medium, Large
80,00 €
 Clear

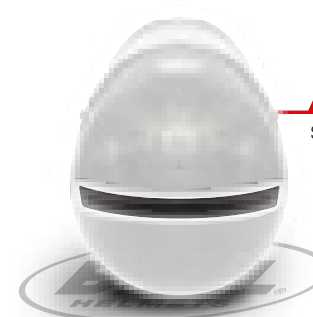

TOP GURNEY
2050081 (S) & 2050083 (L)
Small, Large
35,00 €
 Clear

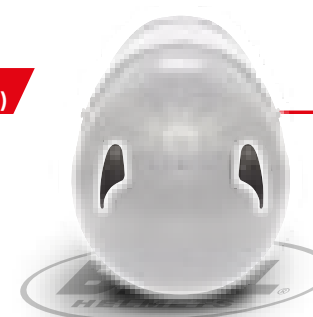

SIDE AIR EXTRACTORS
2060043
30,00 €
 Clear

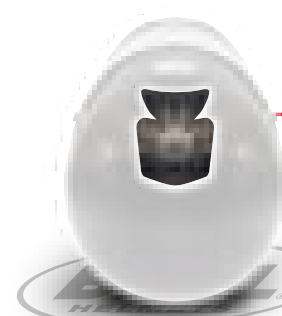

AIR INTAKE CENTRAL KIT (2Pcs)
2060041
35,00 €
 Clear



AIR INTAKE CENTER KIT (1Pcs)
2060072
35,00 €
 Clear

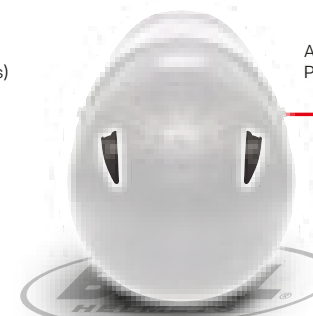

AIR INTAKE LOW PROFILE KIT
2060045
30,00 €
 Clear



CHIN BAR GURNEY
2050061 to 2050063
Medium, Large, Extralarge
35,00 €
 Clear



TOP FORCE AIR 8 HOLES
2070112 V05 180 Degrees
2070237 V05 90 Degrees
2070238 V05 45 Degrees
2070120 V10 Quick lock
160,00 €
Carbon



SE07 COLORED SHIELD
2010411 to 2010428
For HP77 model
SE07 COLORED SHIELD
2010041 to 2010059
For 07 model



COLORED HANS ANCHORS
2100001 to 2100008
65,00 € to 85,00 €

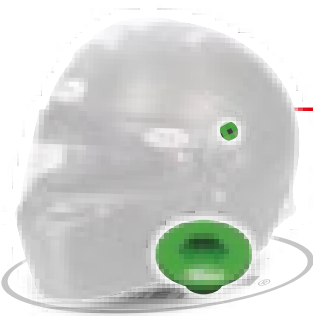

COLORED PIVOT KIT
2020071 to 2020078
25,00 €



COLORED INTERIOR
218xxxx
170,00 €
Colored interiors available only for HP and Carbon series helmets (refer to Bell for part numbers)

Check all the options in the accessories section

Derived from HP6, the GT6 CARBON features the same modern and aggressive design, developed for racers in closed-car environments, featuring a wide eyeport for extended vision with an ultra-lightweight Premium carbon shell. Its ventilation slots can be connected to various types of air intakes for external cooling systems. It can be fitted with optional ear-muffs providing optimal noise insulation, with fully integrated radio communication kit and hydration systems (available separately or in RD version).

- Ultra-lightweight Premium Carbon Composite shell
- Wide eyeport opening for optimal vision in closed cockpit cars (Shield type SE06)
- Advanced multi-density, multi-piece liner to maximize energy absorption and impact performance
- Integrated channels in face piece offering multiple options to install drinking tube, valves and radio systems
- Extraction vents to maximize cooling and air circulation
- Factory installed Hans anchors as original equipment
- Optional Top and Side air intakes available for use with external cooling system
- Compatible with interior parts kits - HP6 RD to incorporate the radio kit and drinking tube kits
- Interior: Dark Grey High Strength - High Comfort FR Fabric
- Alternative interior fabric colors: Tan, White, Red, Purple, Blue, Green, Neon Yellow, Pink and Orange (on special order)
- Color: Carbon, Gloss finish
- Sizes: 54-55-56-57-58-59-60-61-61+ 2XL(63-64)-3XL(65-66)-4XL(67-68)
- Homologation: FIA8859-2015 and SNELL SA2020



FIA APPROVED

MANUFACTURER: BELL RACING HELMETS
MODEL: GT6 CARBON
HOM. NO: PH.108.21-C
FIA STANDARD: 8859-2015

ACCESSORIES AVAILABLE

HP6, HP6 RD, HP6 RALLY, GT6 CARBON, GT6 RD CARBON
GT6 RALLY CARBON, GT6 PRO, GT6 RALLY PRO

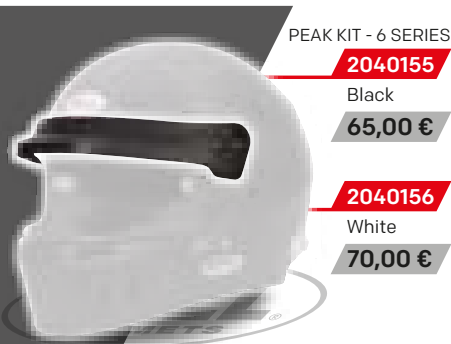

PEAK KIT - 6 SERIES

2040155

Black

65,00 €

2040156

White

70,00 €

SUNSCREEN
SHORT VISOR SE06

2010473

95,00 €

COLORED
HANS ANCHORS

**2100001
to 2100008**

65,00 €
to 85,00 €



Check all the options in the accessories section

DRINKING TUBE KIT

The integrated drinking tube kit includes flexible tubing, L shaped adaptor to properly position the mouth bite valve and a one-way valve for drinking systems. This allows for seamless integration without modifying the face piece or drilling holes in the helmet chin bar (bite valve and drinking system not included).



• RCA connector compatible with Earplug Transducers



• 1/8 Hose Barb Valved In-Line Coupling Body fast connector

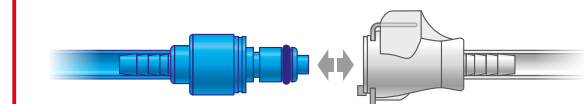

MICROPHONE KIT RCA-CINCH

Bell's 4 connector radio helmet kit features a dynamic noise canceling microphone pre-wired and integrated into the helmet's face piece and optimized to work with industry standard radio systems. The kit includes a coil style cord and ready for use with "in-ear" transducers (ear buds) fitted with RCA-CINCH Female Connector.

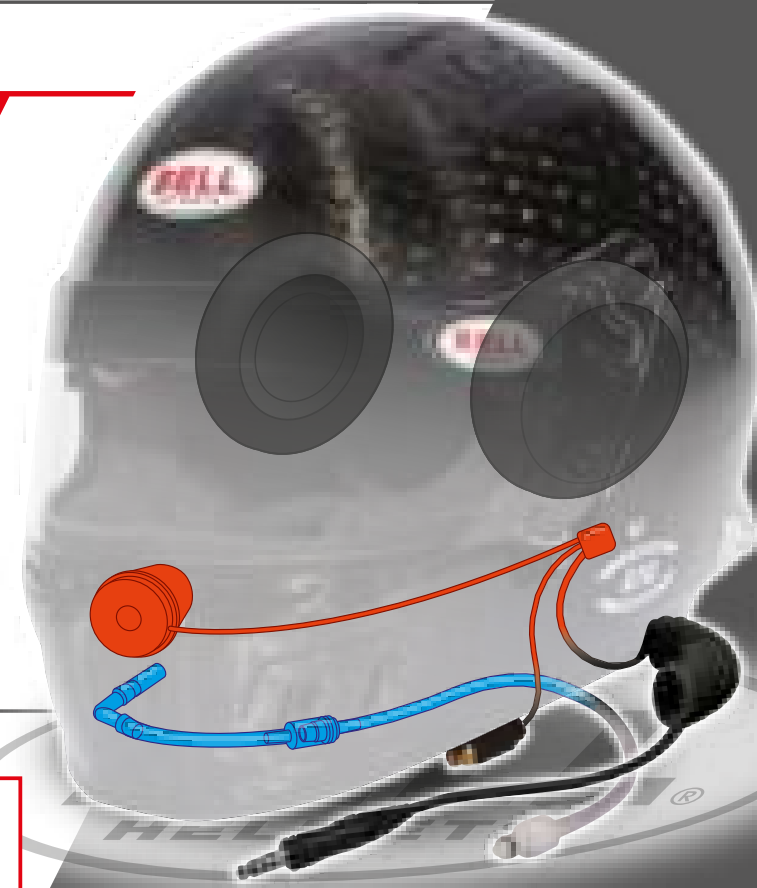

GT6 RD CARBON

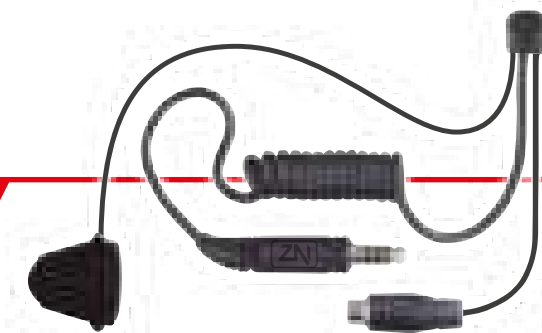

The versatile GTX3 Carbon, used extensively on dirt race tracks around the globe provides industry-leading performance and is a perfect choice for racers competing in open wheel forms of motorsports, especially dirt-track forms of racing. Featuring an ultra-lightweight carbon shell, integrated rear spoiler for enhanced aerodynamic performance at higher speeds, venturi air-exchange system, and double screen anti fog (DSAF) shield, the GTX3 Carbon is ideal for dirt track and other challenging forms of racing.

Combining iconic F1 styling, versatile air-intake system, Ultra-lightweight carbon shell with leading edge aerodynamics, the GP3 Carbon is a visually appealing high performance helmet. Optimized for open-wheel, formula drivers, karters and other circuit racers who demand professional features, performance and comfort, the GP3 Carbon provides maximum ventilation and clear visibility making it suitable for use in the most diverse and demanding racing environments.

- Ultra-lightweight Premium Carbon Composite shell
- Advanced multi-density, multi-piece liner to maximize energy absorption and impact performance
- Optical grade injected Double Screen Anti-Fog (DSAF) visor for anti-fog control and superior visibility
- Rear-facing side chin bar vents and air extraction vents create a venturi-effect to minimize dirt and dust entering the helmet while maximizing air exchange
- Integrated carbon look rear spoiler for enhanced aerodynamic performance
- Integrated channels in face piece offer multiple options to install drink tube and radio systems
- Synthetic rubber gasket seal to prevent dirt and water from entering the helmet
- Factory installed Hans anchors as original equipment
- Shield and pivot kit: SE03 3MM, SV(SE03/SE05)
- Interior: Dark Grey High Strength – High Comfort FR Fabric
- Alternative interior fabric colors: Tan, White, Red, Purple, Blue, Green, Neon Yellow, Pink and Orange (on special order)
- Color: Carbon, Gloss finish
- Sizes: 57-58-59-60-61-61+
- Homologation: FIA8859-2015 & SNELL SA2020



FIA APPROVED

MANUFACTURER: BELL RACING HELMETS
MODEL: GTX3 CARBON-20
HOM. NO: PH.085.20-C
FIA STANDARD: 8859-2015



GTX3 CARBON



DIRT OFF-ROAD

- Full face helmet featuring ultra-lightweight Premium carbon composite shell
- Advanced multi-density, multi-piece liner to maximize energy absorption and impact performance
- Optical grade injected Double Screen Anti-Fog (DSAF) visor for anti-fog control and superior visibility
- Versatile ventilation system featuring lower front chin bar ventilation and upper air-intake vents that can be opened and closed
- Front duckbill (chin spoiler) for improved aerodynamic performance
- Integrated channels in face piece offer multiple options to install drink tube and radio systems
- Factory installed Hans anchors as original equipment
- Synthetic rubber gasket seal to prevent dirt and water from entering the helmet
- Interior: Dark Grey High Strength – High Comfort FR Fabric
- Alternative interior fabric colors: Tan, White, Red, Purple, Blue, Green, Neon Yellow, Pink and Orange (on special order)
- Shield and pivot kit: SE03 3MM, SV(SE03/SE05)
- Color: Carbon, Gloss finish
- Sizes: 57-58-59-60-61-61+
- Homologation: FIA8859-2015 & SNELL SA2020

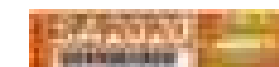

FIA APPROVED

MANUFACTURER: BELL RACING HELMETS
MODEL: GP3 CARBON-20
HOM. NO: PH.084.20-C
FIA STANDARD: 8859-2015



GP3 CARBON

GTX3 CARBON ACCESSORIES AVAILABLE

COLORED INTERIOR

218xxxx
170,00 €

Colored interiors available only for HP and Carbon series helmets (refer to Bell for part numbers)

GTX3 WING KIT

2050093

60,00 €

Carbon

COLORED PIVOT KIT

2020001 to 2020008

25,00 €

SE03 COLORED SHIELD

2010001 to 2010013

95,00 € to 150,00 €

COLORED INTERIOR

218xxxx
170,00 €

Colored interiors available only for HP and Carbon series helmets (refer to Bell for part numbers)

COLORED PIVOT KIT

2020001 to 2020008

25,00 €

COLORED HANS ANCHORS

2100001 to 2100008

65,00 € to 85,00 €

SE03 COLORED SHIELD

2010001 to 2010013

95,00 € to 150,00 €

Check all the options in the accessories section

ACCESSORIES AVAILABLE GP3 CARBON, GP3 SPORT



Based on the HP7 design and featuring a lightweight carbon fiberglass composite shell, the RS7 uses an innovative shell and shield design to improve acoustic comfort, aerodynamic performance, and energy absorbing capabilities. The sleek, modern design features an advanced ventilation system with 14 air-intake and extraction channels that can be used with or without air-intake (available separately). The RS7 double screen anti-fog (DSAF) visor and rubber gasket seal ensure air, water and dust will not enter in the eyeport.

- Lightweight Premium Carbon Fiberglass Composite shell
- Advanced multi-density, multi-piece liner to maximize energy absorption and impact performance
- Optical grade injected Double Screen Anti-Fog (DSAF) visor for anti-fog control and superior visibility
- Powerful and effective top and chin bar ventilation system with 14 air intake and extraction channels for maximum ventilation
- Shell and shield design optimized to improve aerodynamic performance, reduce internal noise, and enhance energy management capacities
- Integrated channels in face piece offering multiple options to install drinking tube, valves and radio systems
- Factory installed Hans anchors as original equipment
- Air Intake, side air extractors, rear spoiler, top and chin bar gurneys available separately
- Synthetic rubber gasket seal to prevent dirt and water from entering the helmet
- Interior: Dark Grey High Strength – High Comfort FR Fabric
- Shield and pivot kit: SE07, SV(SE07)
- Color: White or Matte Black
- Available as well with exciting and trendy Graphics and Matte finish:
 - Stamina Red
 - Stamina Grey
- Sizes: 54-55-56-57-58-59-60-61-61+
- Homologation: FIA8859-2015 & SNELL SA2020



FIA APPROVED

MANUFACTURER: BELL RACING HELMETS
MODEL: RS7-20
HOM. NO.: PH.082.20-C
FIA STANDARD: 8859-2015

Stamina:

“The ability to sustain prolonged physical or mental effort”

A name synonymous with Force. Strength with great impact. The overall design of the helmet represents this strength and vigor with sharp and angular shapes, combined with a modern and geometric aesthetic.

- Same characteristics as RS7 PRO with attractive colour design
 - Stamina Red
 - Stamina Grey
- Sizes: 54-55-56-57-58-59-60-61-61+
- Homologation: FIA8859-2015 & SNELL SA2020



The GT6 PRO features the same modern and aggressive design as HP6, developed for racers in closed-car environments, featuring a wide eyeport for extended vision with a lightweight premium carbon fiberglass shell. Its ventilation slots can be connected to various types of air-intakes for external cooling systems. It can be fitted with optional earcups providing optimal noise insulation, with fully integrated radio communication kit and hydration systems (available separately or in GT6 RD Carbon version).

- Lightweight Premium Carbon Fiberglass Composite shell
- Wide eyeport opening for optimal vision in closed cockpit cars (Shield type SE06)
- Advanced multi-density, multi-piece liner to maximize energy absorption and impact performance
- Integrated channels in face piece offering multiple options to install drinking tube, valves and radio systems
- Extraction vents to maximize cooling and air circulation
- Factory installed Hans anchors as original equipment
- Optional Top forced air intake can be installed on the left or right top side vents - available for use with and external cooling system
- Compatible with interior parts kits - HP6 RD to incorporate the radio kit and drinking tube kits
- Interior: Dark Grey High Strength - High Comfort FR Fabric
- Color: White or Matte Black
- Sizes: 54-55-56-57-58-59-60-61-61+ 2XL(63-64)-3XL(65-66)-4XL(67-68)
- Homologation: FIA8859-2015 and SNELL SA2020



GT6 PRO WHITE

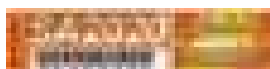

MANUFACTURER: BELL RACING HELMETS
MODEL: GT6
HOM. NO: PH.105.21-C
FIA STANDARD: 8859-2015



GT6 PRO MATTE BLACK

24h LE MANS

In commemoration of the centenary of the 24 Hours of Le Mans, Bell Racing produces a special edition of our GT6 PRO.

This special edition incorporates an attractive design inspired by the most iconic race in the world.

Since 1923, the 24 Hours of Le Mans endurance race has developed its global status as an iconic motorsport event on the basis of a single objective: GET A HEAD START ON THE FUTURE.



GT6 PRO
LE MANS

NEW

- Same characteristics as GT6 PRO with attractive colour design
- HP Helmet bag included
- Sizes: 56-57-58-59-60-61-61+
- Homologation: FIA8859-2015 and SNELL SA2020

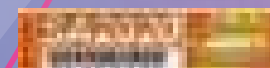

MANUFACTURER: BELL RACING HELMETS
MODEL: GT6
HOM. NO: PH.105.21-C
FIA STANDARD: 8859-2015



OFFICIAL PRODUCT



Check all the options in the accessories section

The new GT5 SPORT is a versatile modern helmet designed primarily for entry level racers who demand quality and performance at a value price. It can be used as a large eyeport helmet with a standard shield or as an open helmet with an adjustable visor peak (optional), combining the feel of an open-face with the protection of a full-face model. The perfect helmet for racers just entering the sport on a budget, it is equally suited for closed cars or open cockpit machinery.

- Fiberglass Composite shell
- Wide eyeport (Shield type SE05)
- Advanced multi-density, multi-piece liner to maximize energy absorption and impact performance
- Integrated channels in face piece offering multiple options to install drinking tube, valves and radio systems
- Ventilation channels
- Available with or without Hans anchors as original equipment
- Interior: Black FR fabric
- Color: White
- Sizes: S, M, L, XL
- Homologation: FIA8859-2015

Available Offshore version:
Color Orange, Without Hans
1442A21 to 1442A24



MANUFACTURER: BELL RACING HELMETS
MODEL: GT5 SPORT-20
HOM. NO: PH.110.21-C
FIA STANDARD: 8859-2015

ACCESSORIES AVAILABLE



PEAK KIT
2040061
to 2040065
50,00 €



REAR SPOILER
2050032
to 2050034
80,00 €

Small,
Medium, Large



SUN SCREEN
LENS KIT
2040091
15,00 €



COLORED PIVOT KIT
2020071
to 2020078
25,00 €



COLORED
HANS ANCHORS
2100001
to 2100008
65,00 €
to 85,00 €

Check all the options in the accessories section

Available with
or without Hans

The GP3 combines traditional F1 styling, a versatile air-intake system, a double screen anti-fog (DSAF) visor and carbon-glass composite shell with leading edge aerodynamic performance. A great option for open-wheel, formula racers and karters who demand professional features, performance, and comfort, the GP3 provides maximum ventilation and clear vision in even the toughest track conditions.

- Full face helmet featuring Premium carbon-glass composite shell
- Advanced multi-density, multi piece liner to maximize energy absorption and impact performance
- Optical grade injected Double Screen Anti-Fog (DSAF) visor for anti-fog control and superior visibility
- Versatile ventilation system featuring lower front chin bar ventilation and upper air-intake vents that can be opened and closed
- Front duckbill (chin spoiler) for improved aerodynamic performance
- Integrated channels in face piece offer multiple options to install drink tube and radio systems
- M6 terminals for FHR anchor attachment and homologated for use with approved head and neck devices
- Available with or without FHR anchors fitted as original equipment
- Synthetic rubber gasket seal to prevent dirt and water from entering the helmet
- Shield and pivot kit: SE03 3MM, SV(SE03/SE05)
- Colors: White and Matte Black
- Sizes: S, M, L, XL
- Homologation: FIA8859-2015



MANUFACTURER: BELL RACING HELMETS
MODEL: GP3 SPORT
HOM. NO: PH.087.20-C
FIA STANDARD: 8859-2015

1417011 to 141714 BLACK
1417031 to 1417034 BLACK HANS

Check all the options in the accessories section

GP3 SPORT MATTE BLACK

Available with or without Hans

Bell's new X-1 all-terrain, extreme helmet is an FIA approved, motocross style racing helmet with Hans anchors for use with head and neck restraint devices that can be worn in multiple disciplines including car-cross, kart-cross, auto-cross, UTV and other forms of off-road racing. The X-1 features a lightweight composite shell, wide-eyeport for use with goggles, sun peak, removable and washable interior, removable rubber breath deflector seal, and chin filter insert to help prevent dust from entering the front chin vents. Ready to take on all surfaces, the Bell X-1 is a purpose-built racing helmet designed for the most demanding off-road environments.

- Lightweight premium composite shell
- Wide eyeport suitable for use with motorsport goggles
- Preinstalled short sun peak
- Easy removable and washable interiors
- Removable rubber breath deflector seal fitted on helmet + rubber breath deflector seal cover flat supplied on the box.
- Front vents on the chin studied to provide fresh air flow to the driver
- Rear air extraction vents
- Color: White
- Sizes: S, M, L, XL
- Homologation: FIA8859-2015



MANUFACTURER: BELL RACING HELMETS
MODEL: X-1
HOM. NO: PH.125.23-C
FIA STANDARD: 8859-2015

NEW



DIRT
OFF-ROAD



VENTILATION

Front vents on the chin studied to provide fresh air flow to the driver.



Removable breath deflector

The removable rubber breath deflector seal allows to modify the free space between the goggles and the helmet, allowing to control the air intake and perfect fit of any goggle.

SUITABLE FOR USE WITH MOTORSPORT GOGGLES

The wide eyeport allows the use of practically all goggles on the standard market.

The design of the helmet ensures the perfect fixation of the goggles, avoiding any possible movement so goggles stay firmly in place during the race.



COMPLETELY REMOVABLE AND WASHABLE INTERIOR

- Special fabric easy to wash and ultra-fast drying.
- Fit pad with bracket anchoring system for a quick assembly and disassembly.
- Cheek pad with velcro system.
- Removable chin dust filter .



Fast bracket anchoring

Cheek pad with velcro system

Special designed dust filter that installs in the front face piece available as accessory

Rally is one of the most challenging racing sports, putting cars and drivers through the toughest and the most varied conditions. To face all these challenges, Bell Helmets and Zeronoise, the electronic division of our group, developed a completely new line of sophisticated rally helmets with the help of top professional rally drivers and teams. Our new rally helmets deliver premium quality and high performance features such as lightweight composite shell, superior comfort and fit, ultra-high quality intercom systems, noise reducing ear protections, soft ear cups combined with ultra-thin and powerful speakers, advanced styling, and of course, optimal protection.

ADVANCED



CARBON



PRO



SPORT



THE BEST RALLY DRIVERS WEAR BELL HPI0 RALLY

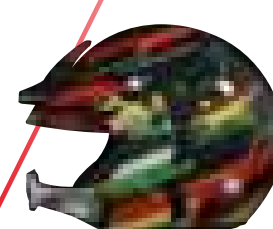
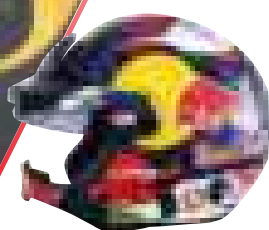

SEBASTIEN LOEB - RED BULL

RALLY

The new Bell HP10 RALLY WW features more technology than ever with the integrated ZeroNoise® Wired-Wireless system. The helmet supports both communication technologies, traditionally wired, and wireless, all rolled into one, without any external elements. Everything is seamlessly integrated: connector, wireless module, battery, and even the well-known ZeroNoise® adaptive noise cancelling algorithm. That means that the helmet is still fully compatible with any other intercom in the market.

The WW (Wired-Wireless) system switches automatically between the two communication technologies without any intervention or interruption. The military-grade wireless module guarantees super-fast communication and a generous distance range of connectivity.

- Open face helmet featuring ultra-lightweight FIA8860-2018 Advanced full carbon shell
- Fast Removable Carbon Half Chin Bar (HCB) quickly and easily detachable to ensure fast access to breathing ways without the need to remove the helmet in case of emergency
- Advanced multi-density, multi-piece liner to maximize energy absorption and impact performance
- Adjustable carbon sun peak
- Adjustable integrated anti-scratch sunscreen: ML Red mirror (M10) fitted as original equipment + dark smoked (M10) supplied in the box
- Removable cheek pads with multi densities advanced materials for optimal comfort
- Flexible yet sound insulating integrated ear muffs for comfort combined with sound insulation
- ZN WW audio system features integrated electronics inside the helmet with adaptive noise cancelling technology for improved WIRED communication
- ZN WW audio system provides wireless connectivity inside and outside the car, with seamless transition between Wired and Wireless mode, and professional audio quality
- Ultra-reliable heavy duty integrated Female Nexus Connector (compatible with other any other Nexus amplifier)
- Detachable right side-cover for smooth integration of the Female Nexus Connector
- Flat right side carbon cover supplied in the box, for those who prefer using a straight cable coming out of the helmet instead of the integrated connector
- Air extraction holes to maximize cooling
- Factory installed Hans anchors as original equipment
- HP helmet bag included
- Interior: Dark Grey High Strength – High Comfort FR Fabric
- Alternative interior fabric colors: Tan, White, Red, Purple, Blue, Green, Neon Yellow, Pink and Orange (on special order)
- Adjustable sunscreens available as accessories in various colors to ensure optimal visual comfort
- Color: Carbon, Matte finish
- Sizes: 54-55-56-57-58-59-60-61-61+
- Homologation: FIA8860-2018

NEW



HP10 RALLY WW



MANUFACTURER: BELL RACING HELMETS
MODEL: HP10 RALLY
HOM. NO.: AH.015.20-0
FIA STANDARD: 8860-2018



HP Helmet Bag included



Adjustable Sunscreen

ML Red mirror fitted as original equipment



Flat right side carbon cover included



WIRED-WIRELESS (WW)

Wired-Wireless (WW) can either work like a standard Nexus wired helmet, or go completely Wireless.

HP10 RALLY WW,
MAG-10 RALLY CARBON,
MAG-10 RALLY WW CARBON,
MAG-10 RALLY PRO

FOCUS ON

* The WW (Wired-Wireless) system is installed in each HP10 Rally WW, and is also available on the MAG-10 Rally WW Carbon model.



RADIO KIT

WIRED MODE

The integrated Female Nexus allows the HP10 RALLY helmet to work as a standard wired helmet.

WIRELESS MODE

As soon as the cable is disconnected, the system switches to Wireless with no discomfort, or interruption in the communication.

Wireless Mode is enabled by ZN FEARLESS WW amplifier.



ZN FEARLESS WW

EARCUPS SPACER FOAM

Foam Spacers can be positioned behind the soft earmuffs to obtain the right level of pressure and insulation.

The kit with thicknesses (10 mm) is included in the box.

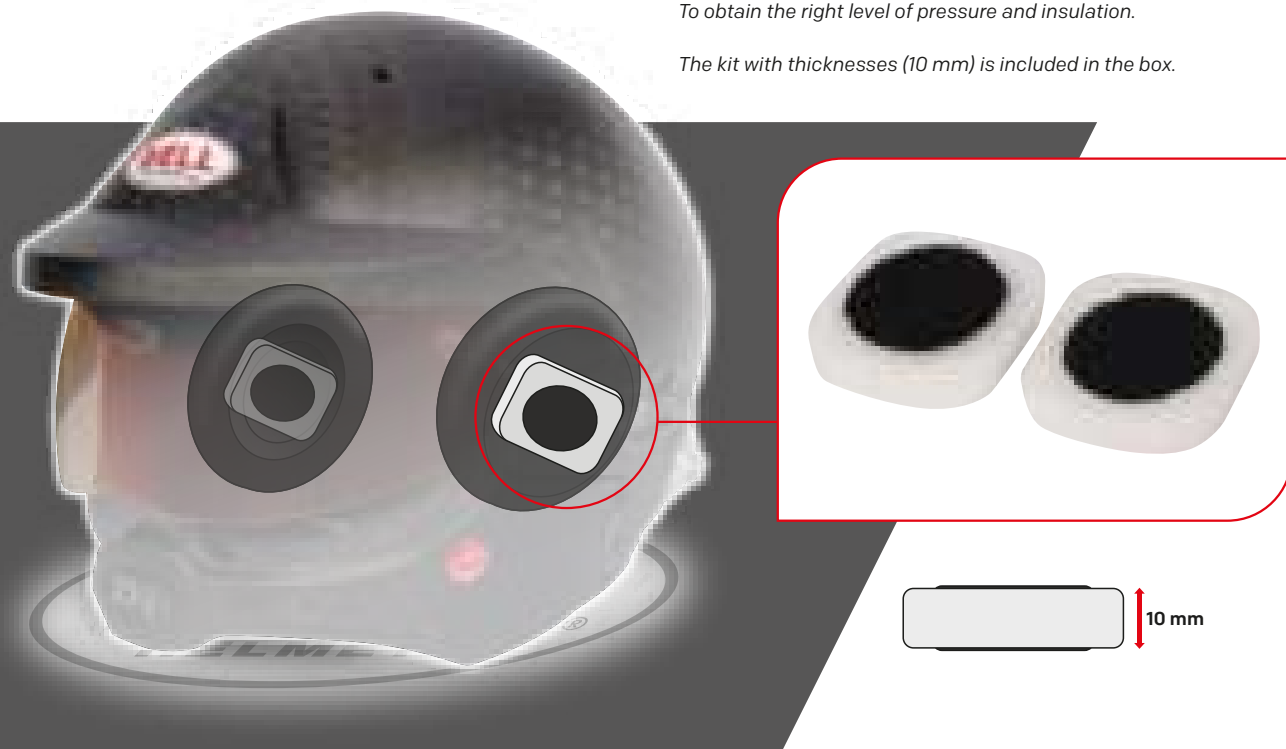

ADJUSTABLE MICROPHONE

The adjustable microphone pieces with different sizes allow a perfect fit of the microphone right in front of the mouth.

Two kits with different thicknesses are included in the box. 15 mm and 33 mm.

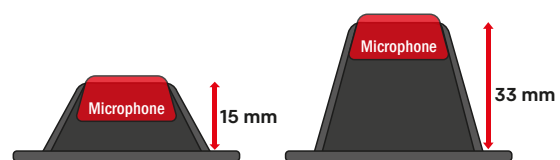

HALF CHIN BAR EMERGENCY FAST REMOVAL

The HP10 Rally WW, Mag-10 Rally Carbon, Mag-10 Rally WW Carbon, and Mag-10 Rally Pro feature an innovative and unique patented system, allowing to disconnect the half chin bar from the helmet very easily and quickly, without the use of any tools. In case of an accident, this unique feature allows the doctors and paramedics to immediately access the breathing airways of an injured driver, without having to remove the helmet. Simply lift the tab, and unscrew the tool-less red screw; once the screw is undone after a few turns, gently pull the half chin bar and that's it!



SIDE COVER CONNECTOR

Ultimate connection flexibility: The HP10 Rally WW, Mag-10 Rally Carbon, Mag-10 Rally WW Carbon and Mag-10 Rally Pro are delivered with a side cover integrating the Nexus female connector.

For those wanting the connector hanging on a loose cable, the connector side cover can easily be replaced with a flat cover.

Flat right side cover is included in the box.



FULL CHIN BAR KIT

The HP10 Rally WW, Mag-10 Rally Carbon and Mag-10 Rally WW Carbon can be transformed by removing the half-chin bar (as installed) and adding full frontal chin protection with Bell's new 10 Series Full Chin Bar Kit. The part is available in carbon fiber finish and only compatible with the 10 series open face rally carbon helmets.

Full Chin Bar Kit is sold as an accessory. Not included in the box.

Incorporating technology used in our state-of-the-art HP7 Advanced Helmets, the HP6 Rally provides the ultimate in closed-face rally helmet performance with its modern and aggressive design, featuring a wide eyeport for extended vision, and a ultra-lightweight Advanced carbon shell. The HP6 Rally integrates the latest technology from ZeroNoise® including advanced electronics, high power speakers and noise canceling microphone to assure outstanding performance, sound insulation and communication efficiency.

- Ultra-lightweight FIA8860-2018 Advanced full carbon shell
- Wide eyeport opening for optimal vision in closed cockpit cars (Sunscreen Short Visor SE06)
- Advanced multi-density, multi-piece liner to maximize energy absorption and impact performance
- Integrated channels in face piece offering multiple options to install drinking tube and valves
- Flexible sound insulating ear muffs, integrated into the interior for comfortable sound insulation
- ZeroNoise® electronics, high power (yet lightweight) speakers and adjustable, efficient noise canceling microphone
- Ultra-reliable heavy duty Female Nexus Connector and external Cord (compatible with other brands of amplifiers)
- Extraction vents to maximize cooling and air circulation
- Factory installed Hans anchors as original equipment
- HP helmet bag included
- Compatible with Bell's drinking tube kits for hydration
- Interior: Dark Grey High Strength – High Comfort FR Fabric
- Alternative interior fabric colors: Tan, White, Red, Purple, Blue, Green, Neon Yellow, Pink, and Orange (on special order)
- Sunscreen Short Shield included (compatible with SE06 shield and 06 Series Peak – sold separately)
- Color: Carbon, Matte finish
- Sizes: 54-55-56-57-58-59-60-61-61+
- Homologation: FIA8860-2018



HP6 RALLY



HP Helmet Bag included



RADIO KIT

- ZeroNoise® Noise cancelling microphone integrated in face piece
- Coil style (curly cable) with heavy duty In-Molded Female Nexus Connector (4 pins)



SUNSCREEN SHORT VISOR

- Wide eyeport opening for optimal vision in closed cockpit cars



SE06 COLORED SHIELD

2010461 to 2010472 95,00 € to 150,00 €



PEAK KIT - 6 SERIES

2040155 2040156

Black White
65,00 € 70,00 €

NEW

FEATURED ACCESSORY

AVAILABLE FOR ALL 6 SERIES

Check all the options in the accessories section



SERIOUS HEAD PROTECTION

MAG-10 RALLY CARBON / CARBON WW

1245011 to 1245019 ST
1245101 to 1245103 WW
1245106 to 1245112 WW

ST 1.200,00 €

WW 1.400,00 €

SIZES: 54 TO 61+

Based on the HP10 Rally, the MAG-10 RALLY CARBON is a sophisticated, ultra-lightweight Premium Helmet in a sleek and modern design that provides a high performance open-face rally helmet. Featuring an ultra-lightweight carbon composite shell combined with our Fast Removable Half Chin Bar (HCB), adjustable carbon fiber peak, brand new adjustable and integrated sunscreen, highly comfortable professional fit combined with outstanding sound-insulation, MAG-10 RALLY CARBON is the new helmet of choice for rally drivers and co-drivers looking for a high-end Premium product. Benefiting from the extensive Research & Development program undertaken for the HP10, the MAG-10 RALLY CARBON sets new standards in the Premium Helmets category! No effort was spared to obtain outstanding performances of sound insulation and communication efficiency, incorporating ZeroNoise® electronics, high power speakers and noise cancelling microphone, and to deliver the best experience in terms of safety, comfort and communication.

- Open face helmet featuring ultra-lightweight Premium carbon composite shell
- Fast Removable Carbon Half Chin Bar (HCB) quickly and easily detachable to ensure fast access to breathing ways without the need to remove the helmet in case of emergency
- Advanced multi-density, multi-piece liner to maximize energy absorption and impact performance
- Adjustable carbon sun peak
- Adjustable integrated anti-scratch dark smoked sunscreen (M10)
- Integrated cheek pads with multi densities advanced materials for optimal comfort
- Flexible yet sound insulating integrated ear muffs for comfort combined with sound insulation
- ZN WW audio system features integrated electronics inside the helmet with adaptive noise cancelling technology for improved WIRED communication
- ZN WW audio system provides wireless connectivity inside and outside the car, with seamless transition between Wired and Wireless mode, and professional audio quality
- Ultra-reliable heavy duty In-Molded Female Nexus Connector (compatible with other brands of amplifiers)
- Detachable right side-cover for smooth integration of the Female Nexus Connector
- Flat right side cover supplied in the box, for those who prefer using a straight cable coming out of the helmet instead of the integrated connector
- Factory installed Hans anchors as original equipment
- Interior: Dark Grey High Strength – High Comfort FR Fabric
- Alternative interior fabric colors: Tan, White, Red, Purple, Blue, Green, Neon Yellow, Pink and Orange (on special order)
- Adjustable sunscreens available as accessories in various colors to ensure optimal visual comfort
- Color: Carbon, Gloss finish
- Sizes: 54-55-56-57-58-59-60-61-61+
- Homologation: FIA8859-2015 & SNELL SA2020



MAG-10 RALLY CARBON

NEW

MAG-10 RALLY CARBON WW

WIRED WIRELESS

The New MAG-10 RALLY CARBON WW maintains the same features as MAG-10 RALLY CARBON and incorporates the same HP10 RALLY WW features in reference to the Wired Wireless system.

ACCESSORIES AVAILABLE

HP10 RALLY, MAG-10 RALLY CARBON, MAG-10 RALLY CARBON WW, MAG-10 RALLY PRO



PEAK KIT
2040130 to 2040133
55,00 € to 90,00 €



HALF CHIN BAR KIT
2081801 to 2081804
145,00 € to 215,00 €



FULL CHIN BAR KIT FOR HP 10 RALLY
2081823
Matte Carbon
315,00 €

FULL CHIN BAR KIT FOR MAG-10 RALLY CARBON
2081824
Glossy Carbon
315,00 €



FIA APPROVED

MANUFACTURER: BELL RACING HELMETS
MODEL: MAG-10 RALLY CARBON
HOM. NO: PH-093.20-0
FIA STANDARD: 8859-2015

Check all the options in the accessories section

RALLY

GT6 RALLY

CARBON

1.300,00 €

SIZES: 54 TO 68

1239131 to 1239139
1239037 to 1239039

Derived from HP6 Rally, the GT6 Rally Carbon features the same modern and aggressive design, developed for racers in closed-car, rally environments, featuring a wide eyeport for extended vision with an ultra-lightweight Premium carbon shell. The closed-face GT6 Rally Carbon integrates the latest technology from ZeroNoise® including advanced electronics, high power speakers and noise canceling microphone to assure outstanding performance, sound insulation and communication efficiency.

- Ultra-lightweight Premium Carbon Composite shell
- Wide eyeport opening for optimal vision in closed cockpit cars (Sunscreen Short Visor SE06)
- Advanced multi-density, multi-piece liner to maximize energy absorption and impact performance
- Integrated channels in face piece offering multiple options to install drinking tube and valves
- Flexible sound insulating ear muffs integrated into the interior for comfortable sound insulation
- ZeroNoise® electronics, high power (yet lightweight) speakers and adjustable, efficient noise canceling microphone
- Ultra-reliable heavy duty Female Nexus Connector and external Cord (compatible with other brands of amplifiers)
- Extraction vents to maximize cooling and air circulation
- Factory installed Hans anchors as original equipment
- Microfiber drawstring helmet bag included
- Compatible with Bell's drinking tube kits for hydration
- Interior: Dark Grey High Strength – High Comfort FR Fabric
- Alternative interior fabric colors: Tan, White, Red, Purple, Blue, Green, Neon Yellow, Pink, and Orange (on special order)
- Sunscreen Short Shield included (compatible with SE06 shield and O6 Series Peak – sold separately)
- Color: Carbon, Gloss finish
- Sizes: 54-55-56-57-58-59-60-61-61+
2XL(63-64)-3XL(65-66)-4XL(67-68)
- Homologation: FIA8859-2015 and SNELL SA2020



GT6 RALLY CARBON

FIA APPROVED

MANUFACTURER: BELL RACING HELMETS
MODEL: GT6 RALLY CARBON
HOM. NO: PH-108-21-C
FIA STANDARD: 8859-2015

ACCESSORIES AVAILABLE

HP6, HP6 RD, HP6 RALLY, GT6 CARBON, GT6 RD CARBON, GT6 RALLY CARBON, GT6 PRO, GT6 RALLY



COLORED INTERIOR
218xxxx
170,00 €

Colored interiors available only for HP and Carbon series helmets (refer to Bell for part numbers)



SE06 COLORED SHIELD
2010461 to 2010472
95,00 € to 150,00 €

Check all the options in the accessories section



Based on the HP10 Rally, the MAG-10 RALLY PRO is a sophisticated, lightweight Premium Helmets in a sleek and modern design that provides a high performance open-face rally helmet. Featuring a lightweight carbon-glass composite shell combined with our Fast Removable Half Chin Bar (HCB), adjustable peak, brand new adjustable and integrated sunscreen, highly comfortable professional fit combined with outstanding sound-insulation, MAG-10 RALLY PRO is the helmet of choice for rally drivers and co-drivers looking for a Premium product. Benefiting from the extensive Research & Development program undertaken for the HP10, the MAG-10 RALLY PRO sets new standards in the Premium Helmets category! No effort was spared to obtain outstanding performances of sound insulation and communication efficiency, incorporating ZeroNoise® electronics, high power speakers and noise cancelling microphone, and to deliver the best experience in terms of safety, comfort and communication.

- Open face helmet featuring lightweight Premium carbon-glass composite shell
- Fast Removable Half Chin Bar (HCB) quickly and easily detachable to ensure fast access to breathing ways without the need to remove the helmet in case of emergency
- Advanced multi-density, multi-piece liner to maximize energy absorption and impact performance
- Adjustable sun peak
- Adjustable integrated anti-scratch dark smoked sunscreen (M10)
- Removable cheek pads with multi densities advanced materials for optimal comfort
- Flexible yet sound insulating integrated ear muffs for comfort combined with sound insulation
- ZeroNoise® electronics, high power (yet lightweight) speakers and efficient noise cancelling microphone
- Ultra-reliable heavy duty In-Molded Female Nexus Connector (compatible with other brands of amplifiers)
- Detachable right side-cover for smooth integration of the Female Nexus Connector
- Flat right side cover supplied in the box, for those who prefer using a straight cable coming out of the helmet instead of the integrated connector
- Factory installed Hans anchors as original equipment
- Interior: Dark Grey High Strength – High Comfort FR Fabric
- Adjustable sunscreens available as accessories in various colors to ensure optimal visual comfort
- Color: White
- Sizes: 54-55-56-57-58-59-60-61-61+
- Homologation: FIA8859-2015 & SNELL SA2020



MAG-10 RALLY PRO

• Available Offshore version:
Color Orange, With Hans
1346021 to 1346029



FIA APPROVED

MANUFACTURER: BELL RACING HELMETS
MODEL: MAG-10 RALLY PRO
HOM. NO: PH.099.21-0
FIA STANDARD: 8859-2015

ACCESSORIES AVAILABLE

**HP10 RALLY, MAG-10 RALLY CARBON
MAG-10 RALLY PRO**

COLORED INTERIOR

218xxxx
170,00 €

Colored interiors available only for HP and Carbon series helmets (refer to Bell for part numbers)



COLORED SUNSCREEN

2040141 to 2040145
55,00 € to 65,00 €



COLORED HANS ANCHORS

2100001 to 2100008
65,00 € to 85,00 €



Check all the options in the accessories section

The GT6 Rally Pro features the same modern and aggressive design as HP6 Rally, developed for racers in closed-car rally environments, featuring a wide eyeport for extended vision with a lightweight Premium carbon glass shell. The closed-face GT6 Rally Pro integrates the latest technology from ZeroNoise® including advanced electronics, high power speakers and noise canceling microphone to assure outstanding performance, sound insulation and communication efficiency.

- Lightweight Premium Carbon Fiberglass Composite shell
- Wide eyeport opening for optimal vision in closed cockpit cars (Sunscreen Short Visor SE06)
- Advanced multi-density, multi-piece liner to maximize energy absorption and impact performance
- Integrated channels in face piece offering multiple options to install drinking tube and valves
- Flexible sound insulating ear muffs integrated into the interior for comfortable sound insulation
- ZeroNoise® electronics, high power (yet lightweight) speakers and adjustable, efficient noise cancelling microphone
- Ultra-reliable heavy duty Female Nexus Connector and external Cord (compatible with other brands of amplifiers)
- Extraction vents to maximize cooling and air circulation
- Factory installed Hans anchors as original equipment
- Draw string helmet bag included
- Interior: Dark Grey High Strength – High Comfort FR Fabric
- Sunscreen Short Shield included (compatible with SE06 shield and O6 Series Peak – sold separately)
- Color: White
- Sizes: 54-55-56-57-58-59-60-61-61+
2XL(63-64)-3XL(65-66)-4XL(67-68)
- Homologation: FIA8859-2015 and SNELL SA2020

FIA APPROVED

MANUFACTURER: BELL RACING HELMETS
MODEL: GT6 RALLY PRO
HOM. NO: PH-105-21-C
FIA STANDARD: 8859-2015



GT6 RALLY PRO

ACCESSORIES AVAILABLE

**HP6, HP6 RD, HP6 RALLY, GT6 CARBON, GT6 RD CARBON
GT6 RALLY CARBON, GT6 PRO, GT6 RALLY**

PEAK KIT - 6 SERIES

2040155

Black

65,00 €

2040156

White

70,00 €



COLORED HANS ANCHORS

2100001 to 2100008

65,00 € to 85,00 €



Check all the options in the accessories section

MAG-10 RALLY SPORT is a conventional open face helmet in a sleek design that provides great performance yet affordable. Featuring a carbon-glass composite shell, an adjustable peak combined with our new adjustable and integrated sunscreen, outstanding sound-insulation and ZeroNoise® electronics, high power speakers and noise cancelling microphone, MAG-10 RALLY SPORT is the perfect helmet for rally drivers and co-drivers looking for a more traditional open face design.

- Open face helmet featuring carbon-glass composite shell
- Advanced multi-density, multi-piece liner to maximize energy absorption and impact performance
- Adjustable sun peak
- Adjustable integrated anti-scratch dark smoked sunscreen (M10)
- Removable cheek pads with multi densities materials for improved comfort
- Flexible yet sound insulating integrated ear muffs for comfort combined with sound insulation
- ZeroNoise® electronics, high power (yet lightweight) speakers and efficient noise cancelling microphone mounted on high quality flex boom
- Extendable curly cable coming out of the helmet, ending by ultra-reliable heavy duty In-Molded Female Nexus Connector (compatible with other brands of amplifiers)
- Factory installed Hans anchors as original equipment
- Interior: Black FR Fabric
- Adjustable sunscreens available as accessories in various colors to ensure optimal visual comfort
- Color: White
- Sizes: XS, S, M, L, XL
- Homologation: FIA8859-2015



MAG-10 RALLY SPORT



- Extendable curly cable coming out of the helmet, ending by ultra-reliable heavy duty In-Molded Female Nexus Connector (compatible with other brands of amplifiers)

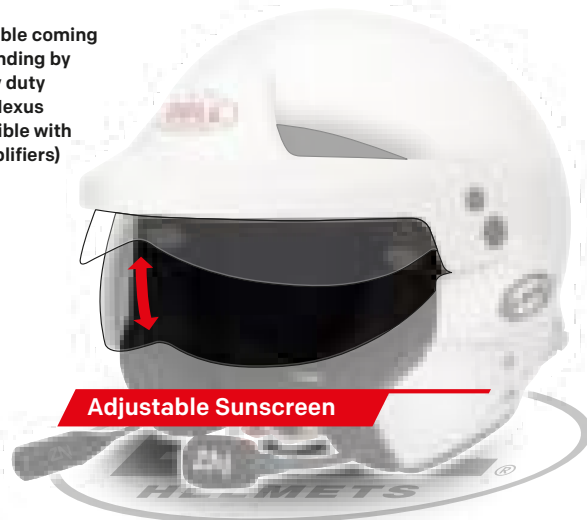

Adjustable Sunscreen

Introducing the all-new MAG RALLY, an entry-level open-face helmet with a contemporary design. Built upon Bell Helmets' proven legacy of "Serious Head Protection," this helmet is enhanced with the remarkable ZeroNoise® communication system. Experience the perfect balance of high-quality safety and powerful communication at an incredibly affordable price, setting a new standard in the industry. Featuring a fiberglass shell, an adjustable peak fitted with antiglare sunscreen and a fantastic communication system, the MAG RALLY is the perfect helmet for rally drivers and co-drivers wanting an entry level and very affordable open face helmet. Thanks to its ZeroNoise® electronics, high power speakers and noise cancelling microphone, the MAG RALLY simply sets new standards in its category.

- Open face helmet featuring fiberglass composite shell
- Adjustable sun peak with antiglare sunscreen
- ZeroNoise® electronics, high power speakers and efficient noise cancelling microphone mounted on high quality flex boom
- Extendable curly cable coming out of the helmet, ending by ultra-reliable heavy duty In-Molded Female Nexus Connector (compatible with other brands of amplifiers)
- Factory installed Hans anchors as original equipment
- Interior: Black FR Fabric
- Color: Titanium Silver Metallic
- Sizes: S, M, L, XL
- Homologation: FIA8859-2015



MAG RALLY



- Extendable curly cable coming out of the helmet, ending by ultra-reliable heavy duty In-Molded Female Nexus Connector (compatible with other brands of amplifiers)

ADVANCED



PAGE 42
HPI0

CARBON



PAGE 44
MAG-10
CARBON



NEW
PAGE 45
MAG-10
CARBON SENNA

PRO



PAGE 46
MAG-10
PRO

SPORT



PAGE 47
MAG



NEW
PAGE 48
MAG
LEMANS



LANDO NORRIS - MCLAREN TEAM

For those drivers who want an open face helmet for circuit racing or for track days, we have plenty of choices from Advanced helmets to Sport helmets, from contemporary design to classic design, from ultra-lightweight to unbeatable value for money.

OPEN FACE HELMETS
CIRCUIT

The new HP10 incorporates the advanced technology of our HP7 state-of-the-art Advanced Helmets in a sleek and modern design that provides the ultimate open-face helmet protection. Featuring an ultra-lightweight carbon shell, adjustable carbon fiber peak, brand new adjustable and integrated sunscreen, and highly comfortable professional fit. HP10 is perfect for racers who want the feeling of an open-face helmet but demand outstanding comfort and superior performance.

- Open face helmet featuring ultra-lightweight FIA8860-2018 Advanced full carbon shell
- Advanced multi-density, multi-piece liner to maximize energy absorption and impact performance
- Adjustable carbon sun peak
- Adjustable integrated anti-scratch sunscreen: ML Red mirror (M10) fitted as original equipment + dark smoked (M10S) supplied in the box
- Removable cheek pads with multi densities foam for optimal comfort
- Air extraction holes to maximize cooling
- Factory installed Hans anchors as original equipment
- HP helmet bag included
- Interior: Dark Grey High Strength – High Comfort FR Fabric
- Alternative interior fabric colors: Tan, White, Red, Purple, Blue, Green, Neon Yellow, Pink and Orange (on special order)
- Adjustable sunscreens available as accessories in various colors to ensure optimal visual comfort
- Color: Carbon, Matte finish
- Sizes: 54-55-56-57-58-59-60-61-61+
- Homologation: FIA8860-2018



Adjustable Sunscreen

ML Red mirror fitted as original equipment



HP Helmet Bag included



dark smoked shield included

<p>PEAK KIT 2040130 to 2040133 55,00 € to 90,00 €</p>	<p>SIDE COVER KIT 2081811 to 2081813 45,00 € to 75,00 €</p>	<p>FULL CHIN BAR KIT FOR HP10 RALLY 2081823 Matte Carbon 315,00 €</p>
<p>COLORED INTERIOR 218xxxx 170,00 €</p> <p>Colored interiors available only for HP and Carbon series helmets (refer to Bell for part numbers)</p>	<p>COLORED HANS ANCHORS 2100001 to 2100008 65,00 € to 85,00 €</p>	<p>COLORED SUNSCREEN 2040141 to 2040145 55,00 € to 65,00 €</p>

Check all the options in the accessories section



HP10

FIA APPROVED

MANUFACTURER: BELL RACING HELMETS
MODEL: HP10
HOM. NO: AH.015.20-0
FIA STANDARD: 8860-2018



The MAG-10 CARBON is a sophisticated, ultra-lightweight Premium Helmets in a sleek and modern design that provides a high performance open-face helmet for racetrack use. Featuring an ultra-lightweight carbon composite shell, an adjustable carbon fiber peak combined with our new adjustable and integrated sunscreen, a highly comfortable professional fit, MAG-10 CARBON is the helmet of choice for racing drivers looking for a high-end super-light Premium open face helmet for circuit use.

- Open face helmet featuring ultra-lightweight Premium carbon composite shell
- Advanced multi-density, multi-piece liner to maximize energy absorption and impact performance
- Adjustable carbon sun peak
- Adjustable integrated anti-scratch dark smoked sunscreen (M10)
- Removable cheek pads with multi densities advanced materials for optimal comfort
- Factory installed Hans anchors as original equipment
- Interior: Dark Grey High Strength – High Comfort FR Fabric
- Alternative interior fabric colors: Tan, White, Red, Purple, Blue, Green, Neon Yellow, Pink and Orange (on special order)
- Adjustable sunscreens available as accessories in various colors to ensure optimal visual comfort
- Color: Carbon, Gloss finish
- Sizes: 54-55-56-57-58-59-60-61-61+
- Homologation: FIA8859-2015 & SNELL SA2020



FIA APPROVED

MANUFACTURER: BELL RACING HELMETS
 MODEL: MAG-10 CARBON
 HOM. NO: PH.093.20-0
 FIA STANDARD: 8859-2015



Adjustable Sunscreen

SENNA

In commemoration of 30-year legacy of Ayrton Senna, Bell Racing present this special MAG-10 CARBON Ayrton Senna edition.

This special edition of the MAG-10 CARBON is finished in carbon with blue gloss finish clear coat inspire on Senna Blue that gives the model a unique and elegant appearance at the same time.

Also incorporating on the sides the original color stripes and Ayrton Senna's symbol that made it recognizable to this day.

- Same characteristics as MAG-10 CARBON with attractive colour design
- Adjustable integrated anti-scratch blue smoked sunscreen
- Adjustable carbon sun peak with blue screw
- Factory installed Hans anchors as original equipment in blue color
- Interior: Blue High Strength-High Comfort FR Fabric
- Color: Carbon with blue gloss finish clear coat inspire on Senna Blue
- Sizes: 54-55-56-57-58-59-60-61-61+
- Homologation: FIA8859-2015 & SNELL SA2020



FIA APPROVED

MANUFACTURER: BELL RACING HELMETS
 MODEL: MAG-10 CARBON
 HOM. NO: PH.093.20-0
 FIA STANDARD: 8859-2015

NEW



HP Helmet Bag included

The MAG-10 PRO is a sophisticated, lightweight Premium Helmet in a sleek and modern design that provides a high performance open-face helmet for racetrack use. Featuring a lightweight carbon-glass composite shell, an adjustable peak combined with our new adjustable and integrated sunscreen, a highly comfortable professional fit, MAG-10 PRO is the helmet of choice for racing drivers looking for a Premium open face helmet for circuit use.

- Open face helmet featuring lightweight Premium carbon-glass composite shell
- Advanced multi-density, multi-piece liner to maximize energy absorption and impact performance
- Adjustable sun peak
- Adjustable integrated anti-scratch dark smoked sunscreen (M10)
- Removable cheek pads with multi densities advanced materials for optimal comfort
- Factory installed Hans anchors as original equipment
- Interior: Dark Grey High Strength – High Comfort FR Fabric
- Adjustable sunscreens available as accessories in various colors to ensure optimal visual comfort
- Color: White
- Sizes: 54-55-56-57-58-59-60-61-61+
- Homologation: FIA8859-2015 & SNELL SA2020



FIA APPROVED
MANUFACTURER: BELL RACING HELMETS
MODEL: MAG-10
HOM. NO: PH.099.21-0
FIA STANDARD: 8859-2015



MAG-10 PRO



Optional Earcups

Providing increased noise insulation
Available for all 10 series helmets

Introducing the all-new MAG: a lightweight, entry-level open-face Premium Helmet with a sleek modern design. Bell Helmets brings you their signature "Serious Head Protection" at an unprecedented affordable price point. With a lightweight fiberglass shell and an adjustable peak equipped with antiglare sunscreen, the MAG offers the ideal solution for amateur drivers in search of a budget-friendly open-face helmet without compromising on safety. Experience the perfect blend of quality, affordability, and uncompromising protection with the MAG by Bell Helmets.

- Open face helmet featuring lightweight Premium fiberglass composite shell
- Adjustable sun peak with antiglare sunscreen
- Available with or without Hans anchors as original equipment
- Interior: Black FR Fabric
- Color: Titanium Silver Metallic
- Sizes: S, M, L, XL
- Homologation: FIA8859-2015

FIA APPROVED
MANUFACTURER: BELL RACING HELMETS
MODEL: MAG
HOM. NO: PH.080.20-0
FIA STANDARD: 8859-2015



MAG
HELME

Available with or without Hans

ACCESSORIES AVAILABLE



PEAK KIT
2040062
50,00 €



SUN SCREEN
LENS KIT
2040091
15,00 €



2100001
to 2100008
65,00 €
to 85,00 €

24h LE MANS®

In commemoration of the centenary of the 24 Hours of Le Mans, Bell Racing produces a special edition of our MAG. This special edition incorporates an attractive design inspired by the most iconic race in the world. Since 1923, the 24 Hours of Le Mans endurance race has developed its global status as an iconic motorsport event on the basis of a single objective: GET A HEAD START ON THE FUTURE.



PASSION AUTHENTIQUE
ENDURANCE



MAG
LE MANS

NEW

- Same characteristics MAG with attractive colour design
- Sizes: S, M, L, XL
- Homologation: FIA8859-2015



MANUFACTURER: BELL RACING HELMETS
MODEL: MAG
HOM. NO: PH.080.20-0
FIA STANDARD: 8859-2015

24h LE MANS®

OFFICIAL PRODUCT



CARBON



PAGE 52
RST7K
CARBON



PAGE 53
KC7 CMR
CARBON

PRO



PAGE 54
RST7K

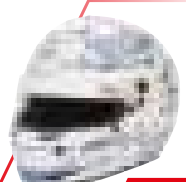

PAGE 55
RST7K
STAMINA WHITE/BLUE



PAGE 55
RST7K
STAMINA YELLOW



PAGE 56
KC7 EV CMS



PAGE 58
KC7 CMR



PAGE 60
KC7 CMR
CHAMPION BLUE



PAGE 60
KC7 CMR
CHAMPION PINK



PAGE 61
KC7 CMR
CHAMPION GREEN



PAGE 61
KC7 CMR
CHAMPION ORANGE



NEW
PAGE 62
KC7 CMR
AYRTON SENNA



PAGE 64
KC7 CMR
LEWIS HAMILTON

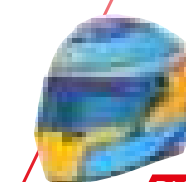

PAGE 65
KC7 CMR
FERNANDO ALONSO



PAGE 66
KC7 CMR
CHARLES LECLERC

THE BEST KARTING DRIVERS WEAR BELL

Karting, a highly demanding discipline in challenging environments, requires top-quality equipment. Our karting helmets are directly derived from our Formula One counterparts, incorporating key characteristics tailored for karting through collaboration with elite drivers. Experience lightweight products, unparalleled comfort, exceptional ventilation, aerodynamics, and an unbeatable defogging system. With carbon as the foundation, our helmets provide the ultimate protection and performance for karting enthusiasts.

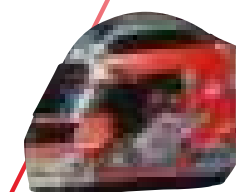

Matheus Morgatto



Paolo Ippolito



Cristian Bertuca

KARTING

The RS7-K Carbon is purpose-built for the karting enthusiast, offering a karting-only version of the RS7 series. It features a lightweight carbon composite shell, derived from the HP7 design, ensuring exceptional durability and performance. The innovative shell and shield design enhance aerodynamics and energy absorption capabilities. With its modern and sleek design, the RS7-K Carbon incorporates an advanced ventilation system for optimum airflow. It also includes a double screen anti-fog (DSAF) shield and a rubber gasket seal, providing reliable protection against water ingress during rainy conditions.

- Ultra-lightweight Premium Carbon Composite shell
- Advanced multi-density, multi-piece liner to maximize energy absorption and impact performance
- Optical grade injected Double Screen Anti-Fog (DSAF) 3MM visor for anti-fog control and superior visibility
- Powerful and effective top and chin bar ventilation system with 14 air intake and extraction channels for maximum ventilation
- Air intake system includes two-part centre and side air intakes (installed)
- Shell and shield design optimized to improve aerodynamic performance, reduce internal noise and enhance energy management capacities
- Rear spoiler available separately
- RS7-K Carbon is NOT compatible with FHR anchor systems or devices
- Synthetic rubber gasket seal to prevent dirt and water from entering the helmet
- Shield and pivot kit: SE07 3MM, SV(SE07)
- Interior: Non-fireproof lining for extra durability
- Black High Strength – High Comfort Fabric and synthetic leather
- Alternative interior fabric colors: Tan, White, Red, Purple, Blue, Green, Neon Yellow, Pink and Orange (on special order)
- Color: Carbon, Gloss finish
- Sizes: 54-55-56-57-58-59-60-61-61+
- Homologation: SNELL K2020

RS7-K CARBON

New Interior lining for extended durability and comfort

Bell continues to innovate with the KC7 CMR Carbon, the first ultra-lightweight carbon youth karting helmet. Based on the advanced HP7 and incorporating the same carbon composite technology, this sleek, aerodynamic design features an advanced ventilation system with 14 air intake and extraction channels designed to maximize cooling and a double screen anti-fog (DSAF) insert to prevent fogging in rainy conditions. Certified to the FIA/Snell CMR standard designed for karting drivers under the age of 18, the KC7 CMR Carbon is a winning choice for the next generation of champion drivers.

- Ultra-lightweight Premium Carbon Composite shell: 1,095g in sizes 54 to 56 and 1,130g in sizes 57 to 59 (+ or - 3%)
- Advanced multi-density, multi-piece liner to maximize energy absorption and impact performance
- Optical grade injected Double Screen Anti-Fog (DSAF) 2MM visor for anti-fog control and superior visibility
- Powerful and effective top and chin bar ventilation system with 14 air intake and extraction channels for maximum ventilation
- Air intake system includes two-part centre and side air intakes (installed)
- Shell and shield design optimized to improve aerodynamic performance, reduce internal noise and enhance energy management capacities
- Rear spoiler available separately
- KC7 Carbon is NOT compatible with FHR anchor systems or devices
- Synthetic rubber gasket seal to prevent dirt and water from entering the helmet
- Shield and pivot kit: SE07 2MM, SV(SE07) (This shield only fit the KC7 Range)
- Interior: Non-fireproof lining for extra durability
- Black High Strength – High Comfort Fabric and synthetic leather
- Alternative interior fabric colors: Tan, White, Red, Purple, Blue, Green, Neon Yellow, Pink and Orange (on special order)
- Color: Carbon, Gloss finish
- Sizes: 54-55-56-57-58-59
- Homologation: SNELL-FIA CMR-2016

KC7 CMR CARBON
FEATURED ACCESSORY

AVAILABLE FOR ALL BELL KARTING HELMETS

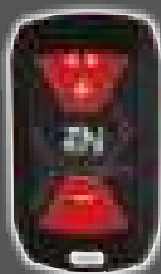
ZERONOISE PIT-LINK TRAINER

 WEARABLE AMPLIFIER
6100031
 158,00 €

 USB C MICORPHONE KIT
6300026
 131,00 €

 EARPLUGS KIT
6300021
 158,00 €

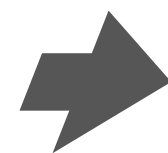
 HEADSET
620000x
 269,00 € to 350 €

DISCOVER THE GRAPHIC AND COLOR OPTIONS

Purpose-built for the hard-charging kart racer, the RS7-K is the karting-only version (non-fire retardant, extra durable interior) of the RS7 series. Based on the HP7 design and featuring a lightweight composite shell, the RS7-K uses an innovative shell and shield design enhancing aerodynamic performance and energy absorbing capacities. The sleek, modern design features an advanced ventilation system, double screen anti-fog (DSAF) visor and a rubber gasket seal ensuring that water does not enter the eye opening in rain conditions.

- Carbon Fiberglass Composite shell
- Advanced multi-density, multi-piece liner to maximize energy absorption and impact performance
- Optical grade injected Double Screen Anti-Fog (DSAF) 3MM visor for anti-fog control and superior visibility
- Powerful and effective top and chin bar ventilation system with 14 air intake and extraction channels for maximum ventilation
- Air intake system and rear spoiler available separately
- Shell and shield design optimized to improve aerodynamic performance, reduce internal noise and enhance energy management capacities
- RS7-K is NOT compatible with FHR anchor systems or devices
- Synthetic rubber gasket seal to prevent dirt and water from entering the helmet
- Shield and pivot kit: SE07 3MM, SV(SE07)
- Interior: Non-fireproof lining for extra durability
- Black High Strength – High Comfort Fabric and synthetic leather
- Color: White
- Available as well with exciting and trendy Graphics and Glossy finish:
 - Stamina White/Blue
 - Stamina Yellow
- Sizes: S, M, L, XL
- Homologation: SNELL K2020



RS7-K

New Interior lining for extended durability and comfort



- Same characteristics as RS7-K with attractive colour design
 - Stamina White/Blue
 - Stamina Yellow
- Sizes: S, M, L, XL
- Homologation: SNELL K2020



RS7-K STAMINA WHITE/BLUE

RS7-K STAMINA

1310A91 to 1310A94

YELLOW

750,00 €

SIZES: S, M, L, XL



RS7-K STAMINA YELLOW



KC7-EV CMS EXTENDED VISION

The KC7-EV CMS is a lightweight youth karting helmet based on the F1 proven HP7 design platform, featuring a large eyeport for enhanced visibility. The sleek, aerodynamic design features an advanced ventilation system that can be used with or without air-intakes to maximize cooling and a double screen anti-fog (DSAF) visor to eliminate fogging. Homologated to the Snell/FIA CMS standard and certified for global competition, the KC7-EV is designed to minimize helmet weight for karting drivers under the age of 18 and perfect for the next generation of champions as they start their racing career in karting.

- Lightweight Carbon Fiberglass Composite shell: 1,185g in sizes 51 to 56 and 1,230g in sizes 57 to 59 (+ or - 3%)
- Advanced multi-density, multi-piece liner to maximize energy absorption and impact performance
- Extra large eyeport for enhanced visibility
- Optical grade injected Double Screen Anti-Fog (DSAF) 2MM visor for anti-fog control and superior visibility
- Powerful and effective top and chin bar ventilation system with 14 air intake and extraction channels for maximum ventilation
- Shell and shield design optimized to improve aerodynamic performance, reduce internal noise and enhance energy management capacities
- Rear spoiler available separately
- KC7-EV is NOT compatible with FHR anchor systems or devices
- Synthetic rubber gasket seal to prevent dirt and water from entering the helmet
- Shield and pivot kit: SE07EV 2MM, SV(SE07) (This shield only fit the KC7-EV CMS)
- Interior: Non-fireproof lining for extra durability
- Black High Strength – High Comfort Fabric and synthetic leather
- Color: White
- Sizes: 51-52-53-54-55-56-57-58-59
- Homologation: SNELL-FIA CMS-2016



SE07EV
COLORED SHIELD
2010351
to 2010355
100,00 €
to 160,00 €

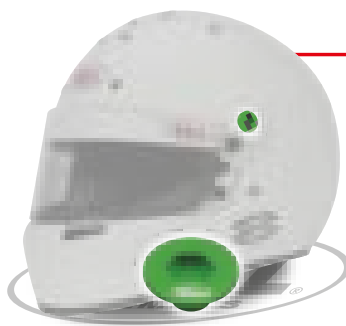

COLORED PIVOT KIT
2020071
to 2020078
25,00 €



Check all the options in the accessories section

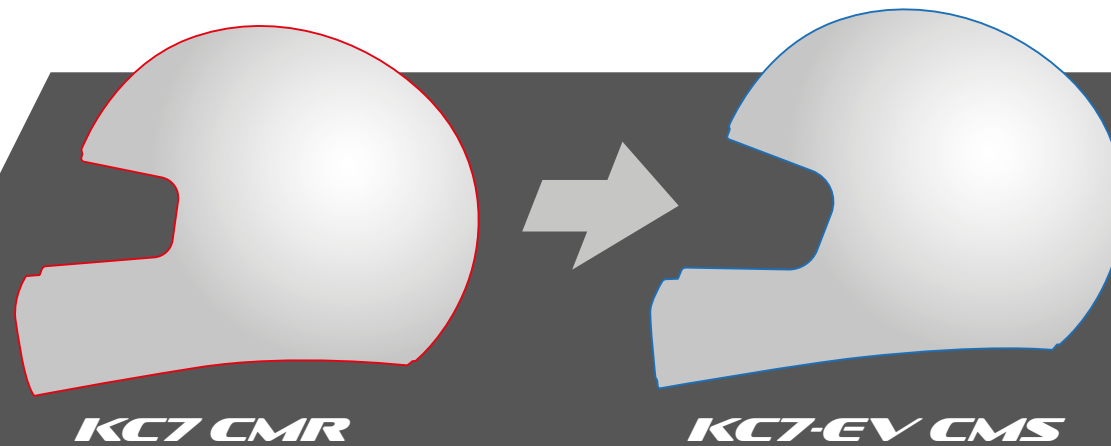

A NATURAL EVOLUTION

- Large eyeport for enhanced visibility
- Visor more than 20mm larger
- 30% more peripheral visibility

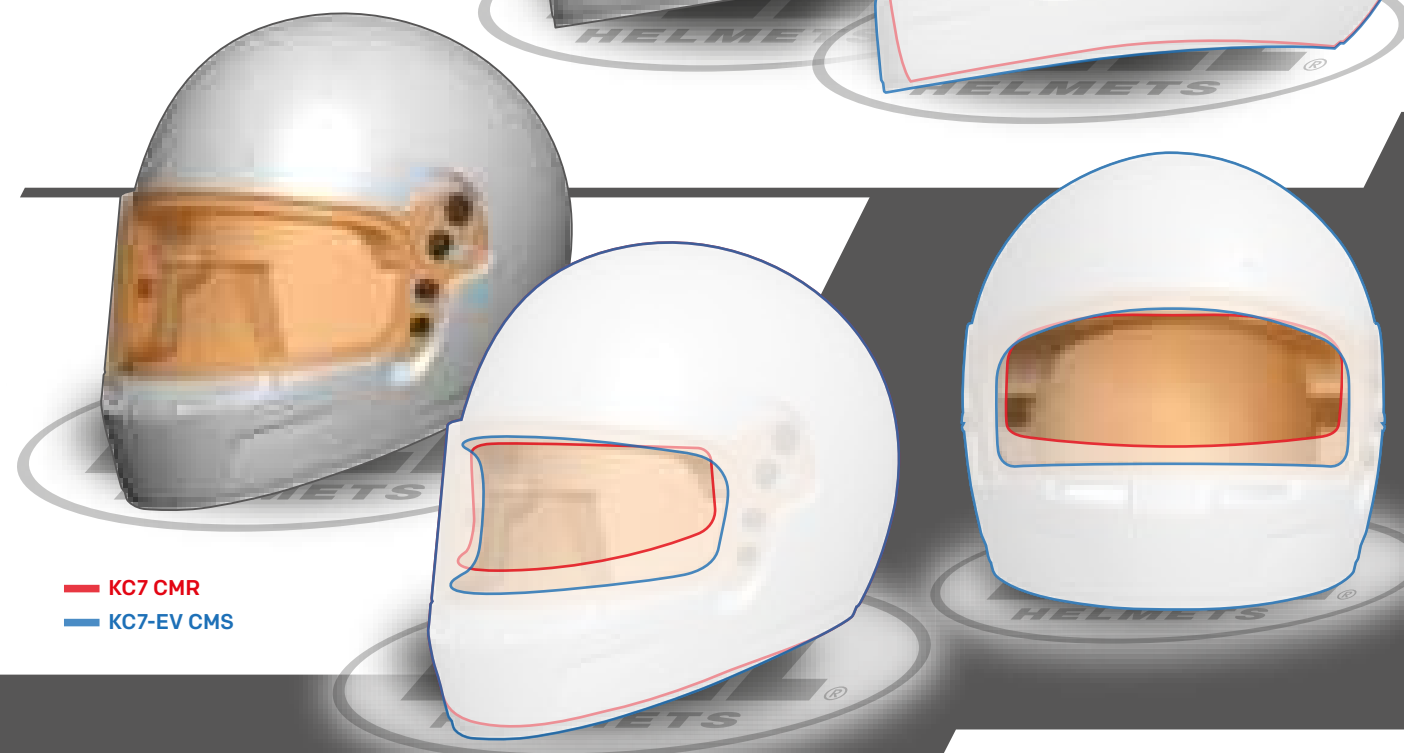
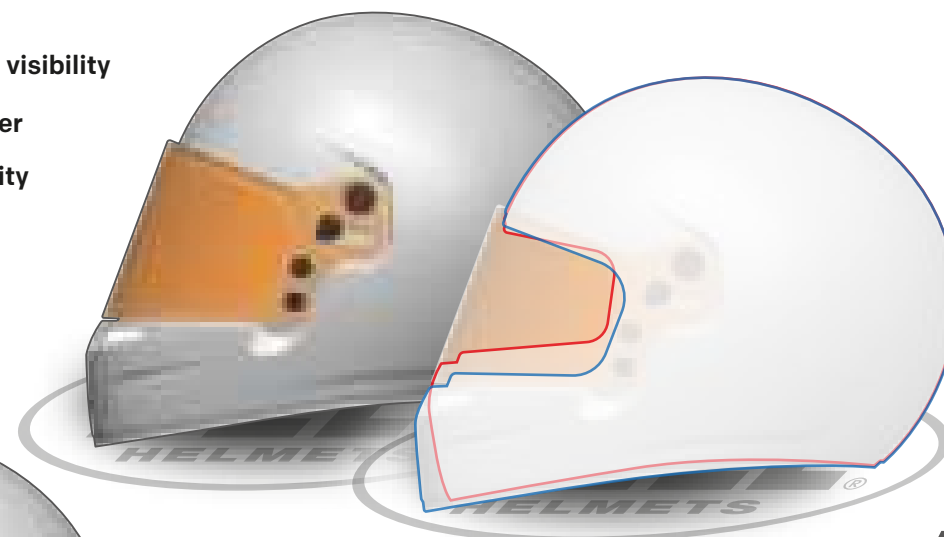

— KC7 CMR
— KC7-EV CMS

**RS7-K CARBON, RS7-K,
KC7 CMR CARBON, KC7 CMR,
KC7-EV CMS**

The KC7 CMR is a lightweight youth karting helmet based on the F1 proven HP7 design platform. The sleek, aerodynamic design features an advanced ventilation system that can be used with or without air-intakes to maximize cooling and a double screen anti-fog (DSAF) visor to eliminate fogging. Homologated to the Snell/FIA CMR standard and certified for global competition, the KC7 is designed to minimize helmet weight for karting drivers under the age of 18 and perfect for the next generation of champions as they start their racing career in karting.

- Lightweight Carbon Fiberglass Composite shell: 1,185g in sizes 52 to 56 and 1,230g in sizes 57 to 59 (+ or - 3%)
- Advanced multi-density, multi-piece liner to maximize energy absorption and impact performance
- Optical grade injected Double Screen Anti-Fog (DSAF) 2MM visor for anti-fog control and superior visibility
- Powerful and effective top and chin bar ventilation system with 14 air intake and extraction channels for maximum ventilation
- Shell and shield design optimized to improve aerodynamic performance, reduce internal noise and enhance energy management capacities
- Rear spoiler available separately
- KC7 is NOT compatible with FHR anchor systems or devices
- Synthetic rubber gasket seal to prevent dirt and water from entering the helmet
- Shield and pivot kit: SE07 2MM, SV(SE07) (This shield only fit the KC7 Range)
- Interior: Non-fireproof lining for extra durability
- Black High Strength – High Comfort Fabric and synthetic leather
- Color: White
- Available as well with exciting and trendy Graphics and Glossy finish:
 - Champion Blue
 - Champion Green
 - Champion Orange
 - Champion Pink
- Sizes: 54-55-56-57-58-59
- Homologation: SNELL-FIA CMR-2016



KC7 CMR
New Interior lining for extended durability and comfort



SE07
COLORED SHIELD
2010081
to 2010095
95,00 €
to 150,00 €

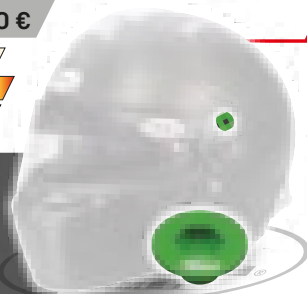

COLORED PIVOT KIT
2020071
to 2020078
25,00 €



COLORED INTERIOR
218xxxx
170,00 €
Colored interiors available only for HP and Carbon series helmets (refer to Bell for part numbers)



REAR SPOILER
2050032
to 2050034
Small, Medium, Large
80,00 €
Clear



TOP GURNEY
2050081 (S)
& 2050083 (L)
Small, Large
35,00 €
Clear



SIDE AIR EXTRACTORS
2060043
30,00 €
Clear



AIR INTAKE LOW PROFILE KIT
2060045
30,00 €
Clear



AIR INTAKE CENTRAL KIT (2Pcs)
2060041
35,00 €
Clear



AIR INTAKE KIT
2060044
60,00 €
Clear



CHIN BAR GURNEY
2050061
to 2050063
Medium, Large, Extralarge
35,00 €
Clear



CIRCLE GROMMET VENT KIT
2060011
15,00 €
Black



CIRCLE GROMMET VENT PLUG KIT
2060013
15,00 €
Black

**DISCOVER THE GRAPHIC
AND COLOR OPTIONS**



Check all the options in the accessories section

Champion:

“A person who surpassed all rivals in a competition”

Every aspiring driver dreams of becoming the next champion. Our design captures the essence of this dream, blending modern and aggressive lines with classic elements inspired by the designs of legendary champions. We understand the desire of new and young drivers to identify with the greats who have come before them. Our design pays homage to these iconic figures, igniting the passion and determination within every debutant driver to chase their own championship aspirations.

- Same characteristics as KC7 CMR with attractive colour design
 - Champion Blue
 - Champion Green
 - Champion Orange
 - Champion Pink
- Sizes: 54-55-56-57-58-59
- Homologation: SNELL-FIA CMR-2016



New Interior lining for extended durability and comfort



**KC7 CMR
CHAMPION BLUE**

1311101 to 1311106



**KC7 CMR
CHAMPION GREEN**

1311111 to 1311116



**KC7 CMR
CHAMPION PINK**

1311131 to 1311136



**KC7 CMR
CHAMPION ORANGE**

1311121 to 1311126

S SENNA

Bell Racing is proud to present this special Ayrton Senna edition of the KC7 CMR.

In commemoration of his 30-year legacy, this helmet is themed on the legendary formula 1 driver Ayrton Senna's helmet to inspire young drivers to invoke excitement and emotion, capturing the essence of his legacy and honoring his enduring impact on the world of motorsports.

This special edition of the KC7 CMR features a 2mm multi-layer SE07 visor, transparent top and side air intakes, transparent rear spoiler and HP helmet bag.



Norio Koike©ASE2023

- Same characteristics as KC7 CMR with attractive colour design
- Clear Top and side Air intakes already mounted on the helmet
- Rear spoiler already mounted on the helmet
- Smoke ML Blue shield Installed (SE07 2mm)
- HP helmet bag included
- Sizes: 54-55-56-57-58-59
- Homologation: SNELL-FIA CMR-2016



HP Helmet Bag included



1311161 to 1311166

AYRTON SENNA
KARTING

NEW



Bell Racing teamed up with F1 drivers Lewis Hamilton, Fernando Alonso and Charles Leclerc to develop special editions of the KC7 CMR. The drivers worked with Bell's in-house designers and custom paint team to create customized graphics for the KC7 CMR with the signature elements and colors of their F1 helmets.

This special editions KC7 CMR feature a multi-layer SE07 2mm visor, clear top and side air intakes, clear rear spoiler and HP helmet bag.

**LEWIS HAMILTON
KARTING**

- Same characteristics as KC7 CMR with attractive colour designs
- Clear Top and side Air intakes already mounted on the helmet
- Rear spoiler already mounted on the helmet
- Smoke ML Purple shield Installed (SE07 2mm)
- HP helmet bag included
- Sizes: 54-55-56-57-58-59
- Homologation: SNELL-FIA CMR-2016



1311081 to 1311086

**LEWIS HAMILTON
KARTING**



HP Helmet Bag included



**FERNANDO ALONSO
KARTING**

- Same characteristics as KC7 CMR with attractive colour designs
- Clear Top and side Air intakes already mounted on the helmet
- Rear spoiler already mounted on the helmet
- Smoke ML Blue shield Installed (SE07 2mm)
- HP helmet bag included
- Sizes: 54-55-56-57-58-59
- Homologation: SNELL-FIA CMR-2016



1311091 to 1311096

**FERNANDO ALONSO
KARTING**



HP Helmet Bag included



CHARLES LECLERC KARTING

- Same characteristics as KC7 CMR with attractive colour designs
- Clear Top and side Air intakes already mounted on the helmet
- Rear spoiler already mounted on the helmet
- Smoke ML Red shield Installed (SE07 2mm)
- HP helmet bag included
- Sizes: 54-55-56-57-58-59
- Homologation: SNELL-FIA CMR-2016



HP Helmet Bag included



1311141 to 1311146

CHARLES LECLERC
KARTING



LEWIS HAMILTON



FERNANDO ALONSO

CHARLES LECLERC



SERIOUS HEAD PROTECTION

HELMETS



1954

JIM BRYAN

BRYAN WON THE 1958 INDIANAPOLIS 500 WEARING A BELL HELMET

Bell Helmets pioneered the motorsport helmet in 1954 and made notable advancements in its design a few years later by introducing expanded polystyrene (EPS) foam

The 500-TX, one of Bell's earliest open-face helmets, was chosen by the Museum of Modern Art in New York for its exceptional design excellence

The 500-TX helmet holds the distinction of being the first helmet to receive Snell approval, which established a benchmark for product safety within the industry.

In 1966, Bell launched the world's first full-face motorsports helmet and quickly earned the admiration and support of the world's top motorsport racers and enthusiasts.

During the 1970s, numerous renowned drivers such as Jacky Ickx, Jackie Stewart, Niki Lauda, Gilles Villeneuve, and many others entrusted the protection of their heads to the Bell Star helmet

Fast-forwarding 50-odd years, Bell is once again introducing the 500-TX Classic and the Star Classic, much to the delight of dedicated classic car enthusiasts and historic car drivers

The same shape as the famous original Bell Helmets are reintroduced but produced to the last safety standard (FIA 8859/SNELL SA2020) using the latest production techniques and high tech materials.



HERITAGE



PAGE 70

STAR CLASSIC



PAGE 71

500-TX CLASSIC



PAGE 72

MAG-1



OPEN FACE & FULL FACE HELMETS

CLASSIC



Famous Bell Star design as worn by famous F1 drivers in the seventies. Fast-forwards 50-odd years and Bell is again launching this iconic helmet to the delight of true classic car enthusiasts and historic car drivers. The same shape as the famous original Bell Helmets are reintroduced but produced to the last safety standard (FIA 8859/SNELL SA2020) using the latest production techniques and high tech materials and featured in our special Bell Heritage White color with a gloss finish.

- Fiberglass composite shell
- Advanced one-density, single-piece liner to maximize energy absorption and impact performance
- M6 terminals for FHR anchor attachment and homologated for use with approved head and neck devices
- Synthetic rubber gasket seal to prevent dirt and water from entering the helmet
- Interior: Tan High Strength – High Comfort FR Fabric
- Shield and pivot kit: Clear Star Classic
- Smoked shield available as an accessory
- Color: Bell Heritage White
- Sizes: S, M, L, XL
- Homologation: FIA8859-2015 & SNELL SA2020

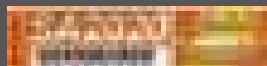

FIA APPROVED

MANUFACTURER: BELL RACING HELMETS
MODEL: STAR CLASSIC
HOM. NO: PH.106.21-C
FIA STANDARD: 8859-2015



STAR CLASSIC

Hans not included

ACCESSORIES AVAILABLE

STAR CLASSIC

SHIELD STAR CLASSIC SMOKE

2010131 to 2010132

95,00 €

COLORED HANS ANCHORS

2100001 to 2100008

65,00 € to 85,00 €

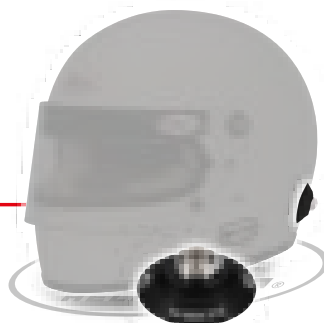

Classic open face helmet based on the famous Bell 500-TX. Fast-forwards 50-odd years and Bell is again launching this iconic helmet to the delight of true classic car enthusiasts and historic car drivers. The same shape as the famous original Bell Helmets are reintroduced but produced to the last safety standard (FIA 8859/SNELL SA2020) using the latest production techniques and high tech materials and featured in our special Bell Heritage White color with a gloss finish.

- Open face helmet featuring fiberglass composite shell
- Provided with removable Peak
- M6 terminals for FHR anchor attachment and homologated for use with approved head and neck devices
- Interior: Tan High Strength – High Comfort FR Fabric
- Color: Bell Heritage White
- Sizes: S, M, L, XL
- Homologation: FIA8859-2015 & SNELL SA2020



FIA APPROVED

MANUFACTURER: BELL RACING HELMETS
MODEL: 500-TX
HOM. NO: PH.103.21-0
FIA STANDARD: 8859-2015



500-TX CLASSIC

Hans not included

ACCESSORIES AVAILABLE

500-TX CLASSIC

COLORED HANS ANCHORS

2100001 to 2100008

65,00 € to 85,00 €

65,00 € to 85,00 €



The Bell tradition of building high-quality open face helmets with classic styling inspired by the original Bell 500-TX lives on in the MAG-1. Designed for racers who enjoy the feel of a classic open face helmet, the MAG-1 delivers value and quality at an affordable price.

- Open face helmet featuring carbon-glass composite shell
- Advanced multi-density, multi piece liner to maximize energy absorption and impact performance
- Adjustable sun peak with antiglare sunscreen
- Factory installed Hans anchors as original equipment
- Color: White
- Sizes: S, M, L, XL
- Homologation: FIA8859-2015

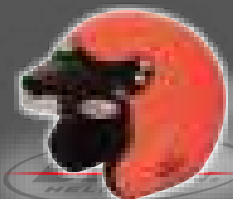

• Available Offshore version:
Color Orange, Without Hans
1426A41 to 1426A44



MANUFACTURER: BELL RACING HELMETS
MODEL: MAG-1*
HOM. NO: PH.014.15-0
FIA STANDARD: 8859-2015

ACCESSORIES AVAILABLE

MAG-1



PEAK KIT
2040001
50,00 €

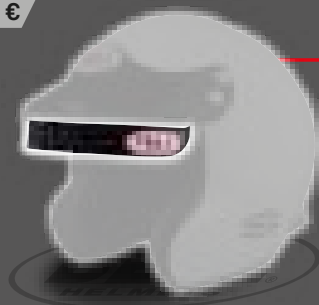

SUN SCREEN
LENS KIT
2040002
15,00 €



COLORED HANS ANCHORS
2100001 to 2100008
65,00 € to 85,00 €





SERIOUS HEAD PROTECTION



ACCESSORIES

SHIELD

PAGE 76

PEAK KIT

PAGE 80

PIVOT KIT

PAGE 81

AERO

PAGE 82

INTERIOR

PAGE 83

HANS

PAGE 83

FORCED AIR

PAGE 84

TEAR-OFFS

PAGE 87

CLEANING KITS

PAGE 87

AIR INTAKE

PAGE 88

REPLACEMENT KITS

PAGE 90

BAGS

PAGE 92

APPAREL

PAGE 94

COMMUNICATION DEVICES

PAGE 99



REGULAR COLORS



CLEAR



SMOKE



DARK



YELLOW

**CHECK THE
COLOR
POSSIBILITIES
WITH YOUR
SHIELD MODEL**

MIRROR COLORS

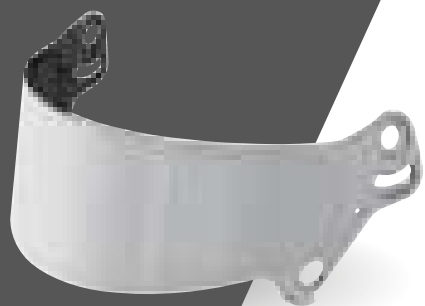

SILVER



GOLD



BLUE



PINK-RED



IRRIDIUM

MULTILAYERS COLORS



RED SMOKE



BLUE SMOKE



GREEN SMOKE

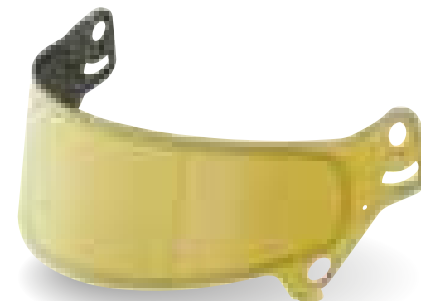

GOLD SMOKE



PURPLE SMOKE

SE 077 3MM HP77



REGULAR DSAF

CLEAR	2010411	140,00 €
SMOKE	2010412	140,00 €
DARK	2010413	140,00 €
YELLOW	2010428	140,00 €

MIRROR DSAF

SILVER	2010415	170,00 €
GOLD	2010416	170,00 €
BLUE	2010417	170,00 €
PINK-RED	2010418	170,00 €
IRRIDIUM	2010426	170,00 €

MULTILAYERS (ML) DSAF

RED SMOKE	2010419	195,00 €
BLUE SMOKE	2010420	195,00 €
GREEN SMOKE	2010421	195,00 €
GOLD SMOKE	2010422	195,00 €
PURPLE SMOKE	2010429	195,00 €

SE 07 3MM HP7, RS7 CARBON, RS7 PRO, RS7-K



REGULAR DSAF

CLEAR	2010041	95,00 €
SMOKE	2010042	95,00 €
DARK	2010043	95,00 €
YELLOW	2010057	95,00 €

MIRROR DSAF

SILVER	2010045	130,00 €
GOLD	2010046	130,00 €
BLUE	2010047	130,00 €
PINK-RED	2010048	130,00 €
IRRIDIUM	2010049	130,00 €

MULTILAYERS (ML) DSAF

RED SMOKE	2010050	150,00 €
BLUE SMOKE	2010051	150,00 €
GREEN SMOKE	2010052	150,00 €
GOLD SMOKE	2010056	150,00 €
PURPLE SMOKE	2010058	150,00 €

SE 07 2MM KC7 CMR



REGULAR DSAF

CLEAR	2010081	95,00 €
SMOKE	2010082	95,00 €
DARK	2010083	95,00 €
YELLOW	2010094	95,00 €

MIRROR DSAF

SILVER	2010085	130,00 €
GOLD	2010086	130,00 €
BLUE	2010087	130,00 €
PINK-RED	2010088	130,00 €
IRRIDIUM	2010089	130,00 €

MULTILAYERS (ML) DSAF

RED SMOKE	2010090	150,00 €
BLUE SMOKE	2010091	150,00 €
GREEN SMOKE	2010092	150,00 €
RED CLEAR	2010093	150,00 €
PURPLE SMOKE	2010095	150,00 €

SE 07 EV 2MM KC7-EV CMS



REGULAR DSAF

CLEAR	2010351	100,00 €
SMOKE	2010352	100,00 €
YELLOW	2010353	100,00 €

MIRROR DSAF

BLUE	2010354	160,00 €
------	---------	----------

MULTILAYERS (ML) DSAF

RED SMOKE	2010355	160,00 €
-----------	---------	----------

SE 06 3MM HP6, HP6 RD, HP6 RALLY, GT6 CARBON, GT6 RD CARBON, GT6 RALLY CARBON, GT6 PRO, GT6 RALLY PRO



REGULAR AS/AF

CLEAR	2010461	95,00 €
SMOKE	2010462	95,00 €
DARK	2010463	95,00 €

MIRROR AS/AF

SILVER	2010464	130,00 €
GOLD	2010465	130,00 €
BLUE	2010466	130,00 €
PINK-RED	2010467	130,00 €
IRRIDIUM	2010468	130,00 €

MULTILAYERS (ML) AS/AF

RED SMOKE	2010469	150,00 €
BLUE SMOKE	2010470	150,00 €
GREEN SMOKE	2010471	150,00 €
PURPLE SMOKE	2010472	150,00 €

SE 06 3MM SUNSCREEN SHORT VISOR



HP6, HP6 RD, HP6 RALLY, GT6 CARBON, GT6 RD CARBON, GT6 RALLY CARBON, GT6 PRO, GT6 RALLY PRO

DARK	2010473	95,00 €
------	---------	---------

AF: Anti Fog AS: Anti Scratch DSAF: Double Side Anti Fog

SE 05 3MM HP5 TOURING, GT5 TOURING, GT5 RALLY, GT5 SPORT,



REGULAR AS/AF

CLEAR	2010021	70,00 €
SMOKE	2010022	70,00 €
DARK	2010023	70,00 €

MIRROR

SILVER	2010024	95,00 €
GOLD	2010025	95,00 €
BLUE	2010026	95,00 €
PINK-RED	2010027	95,00 €
IRRIDIUM	2010028	95,00 €

MIRROR DSAF EYEPORT RUBBER MOLDING

SILVER	2010034	130,00 €
GOLD	2010035	130,00 €
BLUE	2010036	130,00 €
PINK-RED	2010037	130,00 €
IRRIDIUM	2010038	130,00 €

REGULAR DSAF EYEPORT RUBBER MOLDING

CLEAR	2010031	95,00 €
SMOKE	2010032	95,00 €
DARK	2010033	95,00 €
YELLOW	2010039	95,00 €

DSAF INSERT

DSAF INSERT V15 SE05 EYEPORT RUBBER BELL HELMET

CLEAR	2010219	40,00 €
-------	---------	---------

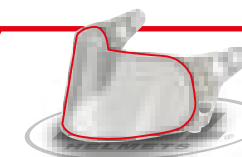

SE 03 3MM GP3 CARBON, GP3 SPORT, GTX3 CARBON, HP3, RS3, KF3



REGULAR DSAF

CLEAR	2010001	95,00 €
SMOKE	2010002	95,00 €
DARK	2010003	95,00 €
YELLOW	2010013	95,00 €

MIRROR DSAF

SILVER	2010005	130,00 €
GOLD	2010006	130,00 €
BLUE	2010007	130,00 €
PINK-RED	2010008	130,00 €
IRRIDIUM	2010009	130,00 €

MULTILAYERS (ML) DSAF

RED SMOKE	2010010	150,00 €
BLUE SMOKE	2010011	150,00 €
GREEN SMOKE	2010012	150,00 €

ADJUSTABLE SUNSCREEN M10



HP10, MAG-10 CARBON, MAG-10 PRO, HP10 RALLY WW, MAG-10 RALLY CARBON / WW, MAG-10 RALLY PRO, MAG-10 RALLY SPORT

M10 AS/AS S SIZE

SMOKE	2040141	55,00 €
DARK	2040142	55,00 €
AMBER	2040143	60,00 €

ML RED	2040144	65,00 €
MIRROR BLUE	2040145	60,00 €

WARNING:
This sunscreen is designed to reduce sun reflection and attenuate light transmission. It is not a shield visor.

STAR CLASSIC



STAR CLASSIC

CLEAR	2010131	95,00 €
SMOKE	2010132	95,00 €

HEX WRENCH KEY CHROME



2080001
10,00 €

VISOR STRIPS SE 07, SE 06, SE 05, SE 03 SHIELDS

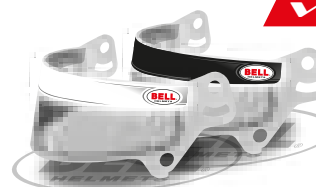

BELL VISOR STRIP WHITE

WHITE	2150001	9,00 €
-------	---------	--------

BELL VISOR STRIP WHITE

BLACK	2150002	9,00 €
-------	---------	--------



BELL VISOR STRIP L.H.

BLACK	2150032	9,00 €
-------	---------	--------



BELL VISOR STRIP F.A.

BLUE	2150033	9,00 €
------	---------	--------

FERNANDO ALONSO KARTING



BELL VISOR STRIP C.L.

RED	2150034	9,00 €
-----	---------	--------

CHARLES LECLERC KARTING



BELL VISOR STRIP A.S.

DARK BLUE	2150045	9,00 €
-----------	---------	--------

AYRTON SENNA KARTING

PEAK KIT



PEAK KIT HP10/HP10 RALLY

■ MATTE CARBON **2040130** 90,00 €



PEAK KIT MAG-10/MAG-10 RALLY

■ GLOSSY CARBON **2040131** 90,00 €
 ■ WHITE **2040132** 55,00 €
 ■ ORANGE **2040133** 55,00 €



PEAK KIT GT5 SPORT

■ WHITE **2040061** 50,00 €
 ■ BLACK **2040062** 50,00 €



PEAK KIT MAG/MAG RALLY

■ BLACK **2040066** 50,00 €



PEAK KIT 6 SERIES

■ BLACK MATTE **2040155** 65,00 €
 ■ WHITE **2040156** 70,00 €



PEAK KIT MAG-1

■ BLACK **2040001** 50,00 €



PEAK KIT 500-TX CLASSIC

■ BLACK **2040157** 50,00 €



PEAK KIT X-1

■ BLACK **2040161** 50,00 €

PIVOT KIT

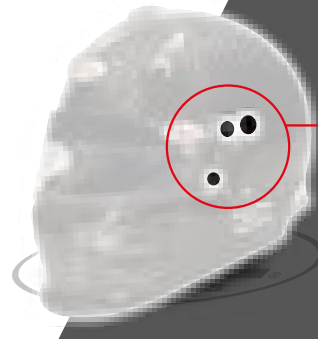

PIVOT KIT SV (SE03/SE05)

PEAK SCREW KIT GT5 SPORT

■ BLACK	2020001	25,00 €
■ BLUE	2020002	25,00 €
■ RED	2020003	25,00 €
■ SILVER	2020004	25,00 €
■ GOLD	2020005	25,00 €
■ PURPLE	2020006	25,00 €
■ GREEN	2020007	25,00 €
■ PINK	2020008	25,00 €

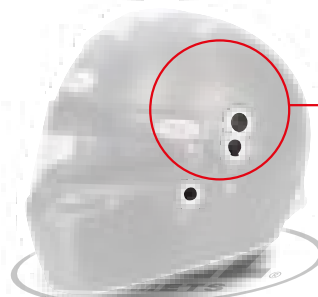

PIVOT KIT SV (SE07 3/2mm/SE077 3mm/SE06/SE07EV 2mm)

■ BLACK	2020071	25,00 €
■ BLUE	2020072	25,00 €
■ RED	2020073	25,00 €
■ SILVER	2020074	25,00 €
■ GOLD	2020075	25,00 €
■ PURPLE	2020076	25,00 €
■ GREEN	2020077	25,00 €
■ PINK	2020078	25,00 €

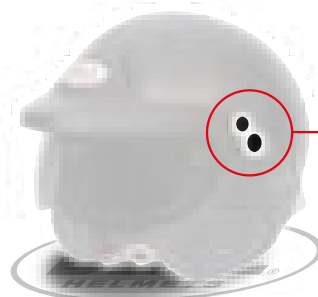

PIVOT KIT M10. All 10 Series

■ BLACK	2020201	25,00 €
■ BLUE	2020202	25,00 €
■ RED	2020203	25,00 €
■ SILVER	2020204	25,00 €
■ GOLD	2020205	25,00 €
■ PURPLE	2020206	25,00 €
■ GREEN	2020207	25,00 €
■ PINK	2020208	25,00 €

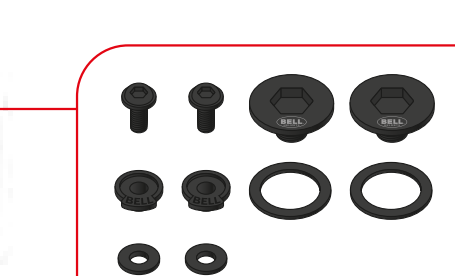
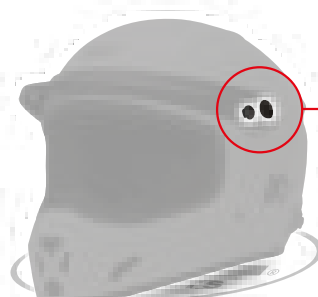

PIVOT KIT X-1

■ BLACK **2020214** 25,00 €

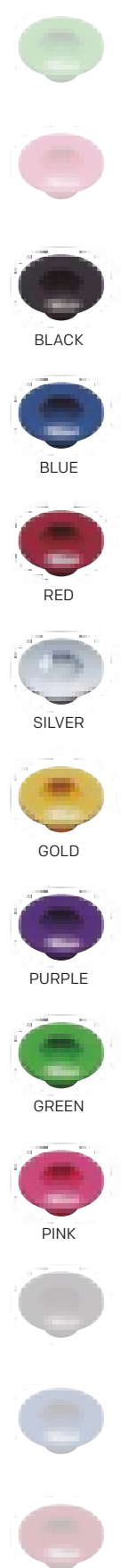

SUN SCREEN LENS KIT



SUN SCREEN MAG-1

■ LIGHT SMOKE **2040002** 15,00 €



SUN SCREEN MAG/MAG RALLY GT5 SPORT

■ LIGHT SMOKE **2040091** 15,00 €

PIVOT KIT

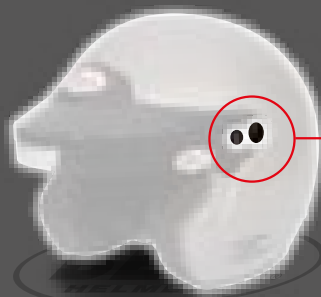

PIVOT KIT MAG/MAG RALLY

BLACK 2020213 25,00 €

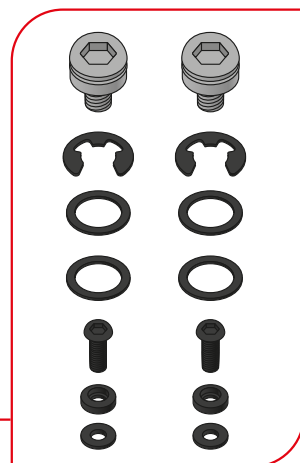

PIVOT KIT STAR CLASSIC

SILVER 2020041 25,00 €

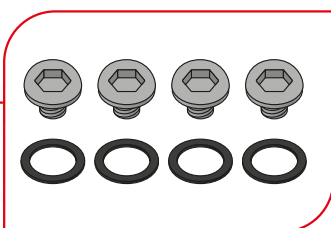
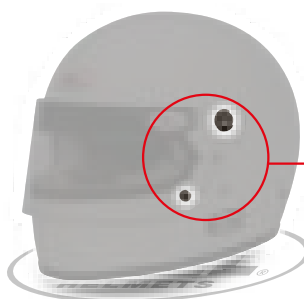

PIVOT KIT MAG-1

SILVER 2020211 25,00 €

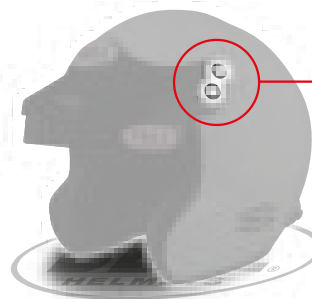

REAR SPOILER

REAR SPOILER HP77/HP7/RS7/KC7/GT5

- CLEAR. SMALL (38mm) 2050032 80,00 €
- CLEAR. MEDIUM (43,5mm) 2050033 80,00 €
- CLEAR. LARGE (49mm) 2050034 80,00 €

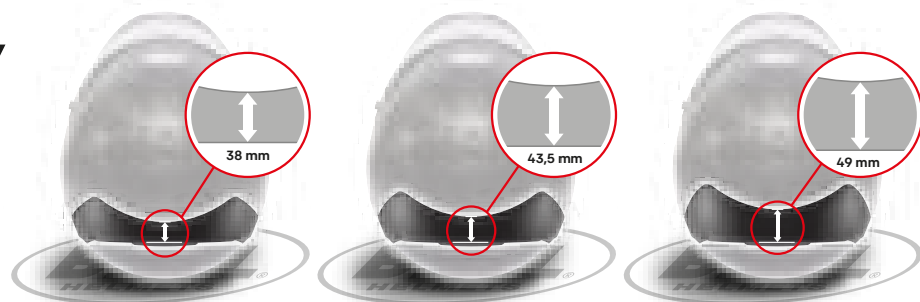

WARNING:
Only the smallest size (38MM) is available for KC7 models

CHIN BAR GURNEY

CHIN BAR GURNEY HP77/HP7/RS7

- CLEAR. MEDIUM (8mm) 2050061 35,00 €
- CLEAR. LARGE (13mm) 2050062 35,00 €
- CLEAR. EXTRA LARGE (17mm) 2050063 35,00 €

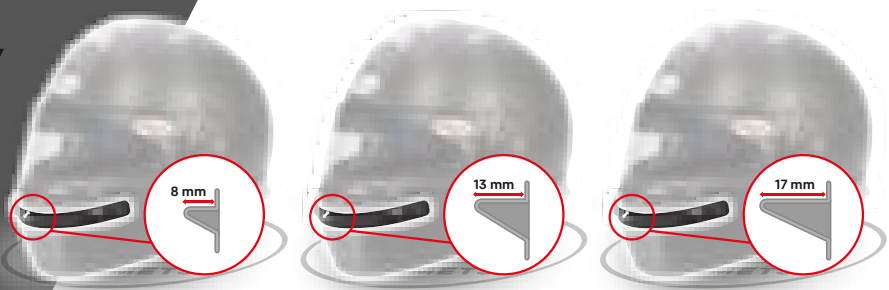

TOP GURNEY

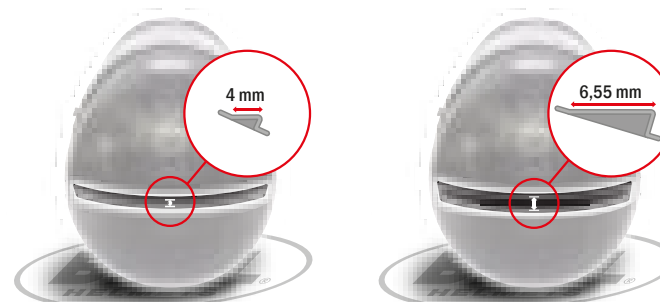

TOP GURNEY HP77/HP7/RS7

- CLEAR. SMALL (4mm) 2050081 35,00 €
- CLEAR. LARGE (6,55mm) 2050083 35,00 €

WING KIT

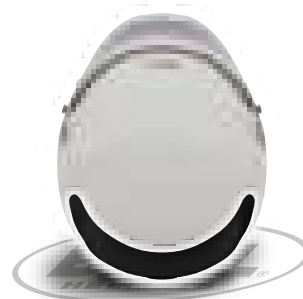

WING KIT GTX3

CARBON LOOK 2050093 60,00 €

INTERIOR KITS

INTERIOR KIT BLACK OR DARK GREY

BLACK OR DARK GREY 218xxxx 380,00 €

INTERIOR KIT COLORED

ALL COLORS 218xxxx 550,00 €

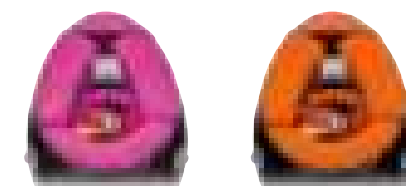
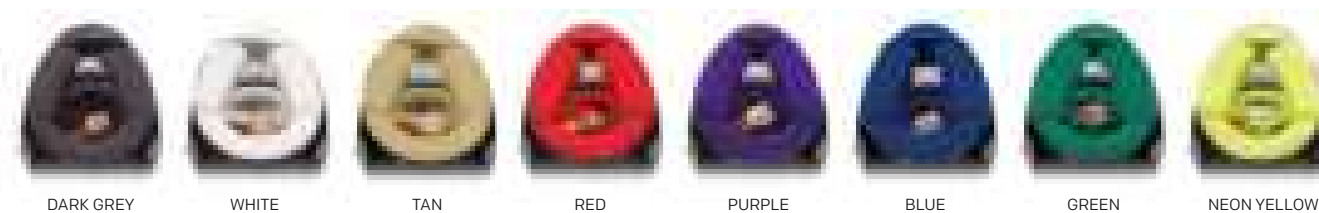

PINK ORANGE

HANS



HANS CLIP SET

- SILVER 2100001 65,00 €
- BLACK 2100002 85,00 €
- BLUE 2100003 85,00 €
- GREEN 2100004 85,00 €
- RED 2100005 85,00 €
- PINK 2100006 85,00 €
- GOLD 2100007 85,00 €
- PURPLE 2100008 85,00 €

FORCED AIR



FORCED AIR TOP EYEPORT KIT HP77/HP7/RS7/HP5/GT5 SPORT

<input type="checkbox"/> CLEAR + NOZZLE V05 180 DEGREE	2070091	145,00 €
<input type="checkbox"/> CLEAR + NOZZLE V05 90 DEGREES	2070244	145,00 €
<input type="checkbox"/> CLEAR + NOZZLE V05 45 DEGREES	2070243	145,00 €
<input type="checkbox"/> CLEAR + NOZZLE V10 QUICK LOCK	2070099	145,00 €



FORCED AIR TOP-LOW KIT HP7/HP77/RS7/GT5 SPORT

<input checked="" type="checkbox"/> CARBON + NOZZLE AIR STANDARD	2070171	160,00 €
--	----------------	----------

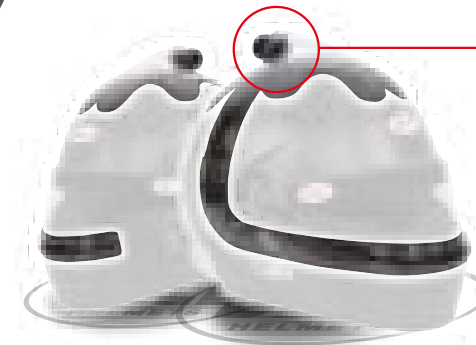

FORCED AIR TOP/SIDE KIT HP77/HP7/RS7

<input type="checkbox"/> CLEAR + NOZZLE V05 45 DEGREES	2070242	170,00 €
<input type="checkbox"/> CLEAR + NOZZLE V05 90 DEGREES	2070241	170,00 €
<input type="checkbox"/> CLEAR + NOZZLE V05 180 DEGREES	2070204	170,00 €
<input type="checkbox"/> CLEAR + NOZZLE V10 QUICK LOCK	2070205	170,00 €

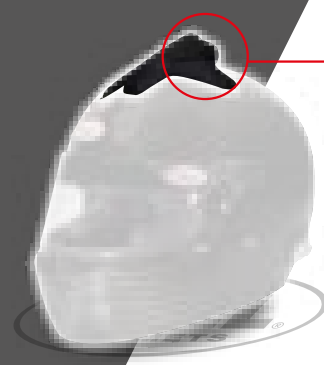

FORCED AIR TOP 8 HOLES KIT HP77/HP7/RS7

<input checked="" type="checkbox"/> CARBON + NOZZLE V05 180 DEGREE	2070112	160,00 €
<input checked="" type="checkbox"/> CARBON + NOZZLE V10 QUICK LOCK	2070120	160,00 €
<input checked="" type="checkbox"/> CARBON + NOZZLE V05 90 DEGREES	2070237	160,00 €
<input checked="" type="checkbox"/> CARBON + NOZZLE V05 45 DEGREES	2070238	160,00 €

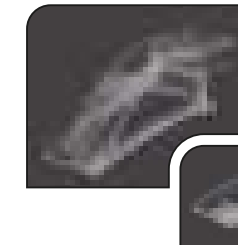
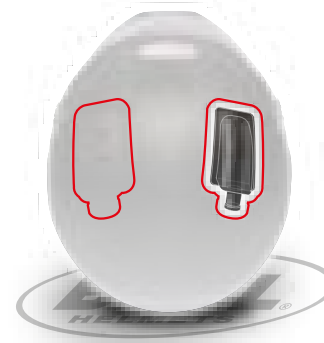

COVER PLATE/FORCED LOW PROFILE NOZZLE KIT 6 SERIES 2070312 50,00 €

<input type="checkbox"/> CLEAR. 1 Pcs FORCED LOW PROFILE NOZZLE
<input type="checkbox"/> CLEAR. 1 Pcs COVER PLATE
<input type="checkbox"/> CLEAR. 2 Sets* SEAL KIT

*Each SEAL KIT set contains 2 pieces of 20 x 80mm and 2 pieces of 20 x 120mm.

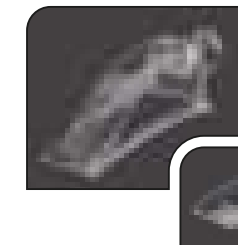

COVER PLATE/FORCED QUICK LOCK NOZZLE KIT 6 SERIES 2070313 50,00 €

<input type="checkbox"/> CLEAR. 1 Pcs FORCED QUICK LOCK NOZZLE
<input type="checkbox"/> CLEAR. 1 Pcs COVER PLATE
<input type="checkbox"/> CLEAR. 2 Sets* SEAL KIT

*Each SEAL KIT set contains 2 pieces of 20 x 80mm and 2 pieces of 20 x 120mm.



FORCED AIR TOP 10 HOLES KIT RS7

<input checked="" type="checkbox"/> CARBON + NOZZLE V05 180 DEGREE	2070132	160,00 €
<input checked="" type="checkbox"/> CARBON + NOZZLE V10 QUICK LOCK	2070140	160,00 €
<input checked="" type="checkbox"/> CARBON + NOZZLE V05 90 DEGREES	2070239	160,00 €
<input checked="" type="checkbox"/> CARBON + NOZZLE V05 45 DEGREES	2070240	160,00 €
<input type="checkbox"/> CLEAR + NOZZLE V05 180 DEGREE	2070131	150,00 €
<input type="checkbox"/> CLEAR + NOZZLE V10 QUICK LOCK	2070139	150,00 €
<input type="checkbox"/> CLEAR + NOZZLE V05 90 DEGREES	2070246	150,00 €
<input type="checkbox"/> CLEAR + NOZZLE V05 45 DEGREES	2070245	150,00 €

NOZZLES

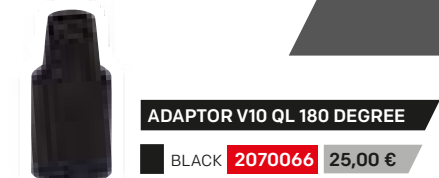

MAGLOCK

Inspired by the dust and heat of Baja, Maglock Air is a revolutionary way to connect racers helmets to their forced air systems. At the heart of this innovation, a machined magnet creates a solid, air tight sealed bond between air hose and helmet using 30 lbs of magnetic tensile force. Solid enough to endure the roughest rides, the connection can be easily broken by a single hand and small amount of pressure when disconnecting from an oblique angle for a "quick-release" extraction. Designed for fast driver changes and quick exit from a racing vehicle, Maglock is the latest innovation in racing safety and performance.

MAGLOCK AIR FULL KIT

BLACK **MLA1000** 245,00 €

MAGLOCK HELMET SIDE

BLACK **MLA1001** 90,00 €

MAGLOCK HOSE SIDE

BLACK **MLA1003** 165,00 €



EASILY CONNECT

DRINKING TUBE KITS

The integrated drink tube kit includes flexible tubing, L shaped adaptor to properly position the mouth bite valve and a one-way valve for drinking systems. This allows for seamless integration without modifying the face piece or drilling holes in the helmet chin bar (bite valve and drinking system not included).

The new drinking tube has the same features as the standard drinking tube and incorporates a new quick connect valve that allows one-handed connection and disconnection.



DRINKING TUBE KIT

CLEAR **2080063** 20,00 €



DRINKING TUBE KIT WITH QUICK CONNECT VALVE

CLEAR **2081821** 85,00 €

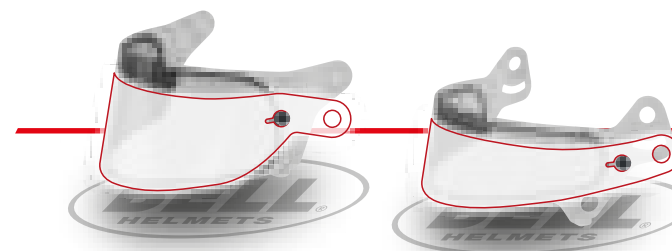

TEAR-OFFS

TEAR-OFFS FOR SE03/SE05 SHIELDS HQ 0.25mm (Pack of 10)

CLEAR **2030001** 30,00 €

TEAR-OFFS FOR SE07 SHIELDS HQ 0.25mm (Pack of 10)

CLEAR **2030002** 30,00 €

TEAR-OFFS FOR SE077 SHIELDS HQ 0.25mm (Pack of 10)

CLEAR **2030003** 30,00 €

TEAR-OFFS FOR 276/281 SHIELDS HQ 0.25mm (Pack of 10)

CLEAR **2030004** 30,00 €

TEAR-OFFS SE06 HQ 0.25mm (Pack of 10)

CLEAR **2030103** 30,00 €

TEAR-OFFS SE07 (VP) Racing optics speedstack(3) 4mil

CLEAR **3435C4** 35,00 €

TEAR-OFFS SE07 (VP) Racing optics x track (10) 4mil

CLEAR **10235C** 50,00 €

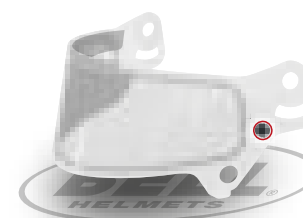

TEAR-OFFS POST KIT - SE SHIELD 3MM BLACK (PLASTIC) BELL HELMET

BLACK **2030082** 5,00 €

TEAR-OFFS POST KIT - SE SHIELD 2MM BLACK (PLASTIC) BELL HELMET

BLACK **2030083** 5,00 €

CLEANING KITS

HELMET CLEANING KIT

2080009 30,00 €



CLEANING CLOTH GREY

2080013 10,00 €

SHIELD CLEANER 99ML

2080011 10,00 €



HELMET INTERIOR CLEANER 99ML

2080012 10,00 €

HELMET CLEANER 99ML

2080010 10,00 €

AIR INTAKE

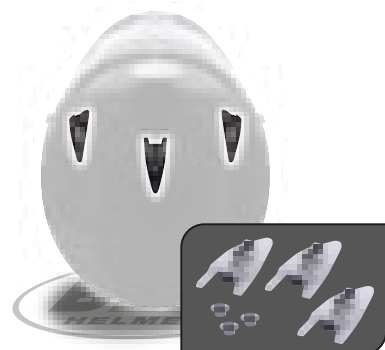

ON/OFF VENTS KIT (3 Pcs) GP3

CLEAR **2060003** 30,00 €



AIR INTAKE CENTRAL KIT (2 PART) HP7/HP77/RS7/HP5/GT5/KC7

CLEAR **2060041** 35,00 €

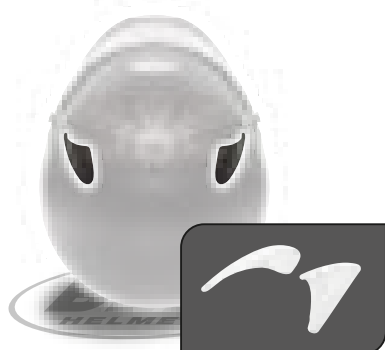

AIR INTAKE SIDE KIT (2 Pcs) HP7/HP77/RS7/HP5/GT5/KC7

CLEAR **2060042** 30,00 €

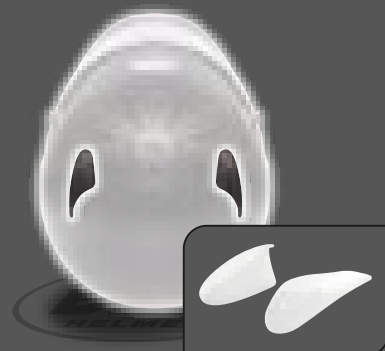

AIR INTAKE SIDE EXTRACTORS KIT (2 Pcs) HP7/HP77/RS7/HP5/GT5/KC7

CLEAR **2060043** 30,00 €



AIR INTAKE KIT (4 Pcs) HP7/HP77/RS7/HP5/GT5/KC7

CLEAR **2060044** 60,00 €



AIR INTAKE LOW PROFILE KIT (2 Pcs) HP7/HP77/RS7/HP5/GT5/KC7

CLEAR **2060045** 30,00 €



AIR INTAKE CENTER KIT (1Pcs) HP7/HP77/RS7/KC7 V19

CLEAR **2060072** 35,00 €

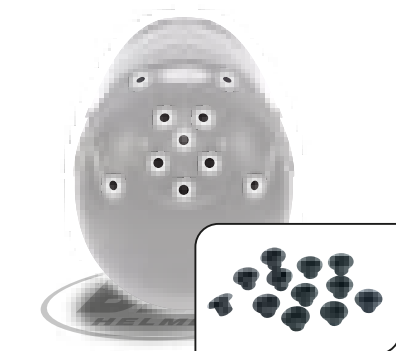

CIRCLE GROMMET VENT KIT (12Pcs) ALL BELL MODELS WITH VENTILATION HOLES DIAMETER 5.5MM.

BLACK **2060011** 15,00 €



CIRCLE GROMMET VENT PLUG KIT (10Pcs) ALL BELL MODELS WITH VENTILATION HOLES DIAMETER 5.5MM.

BLACK **2060013** 15,00 €

REPLACEMENT KITS



HALF CHIN BAR KIT HP10 RALLY WW

MATTE CARBON **2081801** 215,00 €
 MATTE CARBON Short version **2081825** 215,00 €



SIDE FEMALE CONNECTOR KIT HP10 RALLY

MATTE BLACK **2081815** 50,00 €



SIDE COVER KIT (2 Pcs) HP10

MATTE CARBON **2081811** 75,00 €

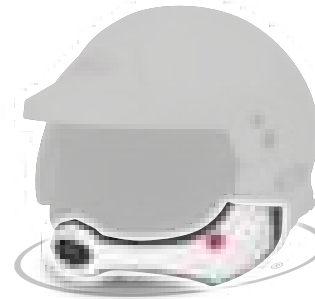

HALF CHIN BAR KIT MAG-10 RALLY

GLOSSY CARBON **2081802** 200,00 €
 WHITTE **2081803** 145,00 €
 ORANGE **2081804** 145,00 €
 GLOSSY CARBON Short version **2081826** 200,00 €



SIDE FEMALE CONNECTOR KIT MAG-10 RALLY

WHITTE **2081817** 50,00 €
 MATTE BLACK **2081815** 50,00 €

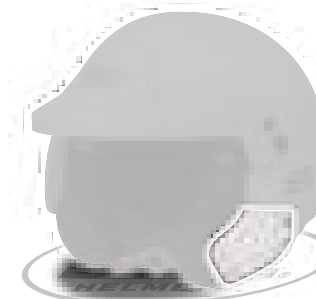

SIDE COVER KIT (2 Pcs) MAG-10

GLOSSY CARBON **2081812** 65,00 €
 WHITTE **2081813** 45,00 €



SCREW KIT HCB HP10/MAG-10 RALLY

ANODIZED RED **2020082** 25,00 €

The kit includes: Red Toll less screw, Black Hinge, and Screw for Hinge two pcs



FOAM KIT HCB HP10/MAG-10 RALLY

BLACK FOAM **2081820** 25,00 €

The kit includes 3 different sizes of cones, HCB filler and HCB cover



FULL CHIN BAR KIT HP AND CARBON 10 SERIES

MATTE CARBON **2081823** 315,00 €

GLOSSY CARBON **2081824** 315,00 €

RUBBER PROFILE

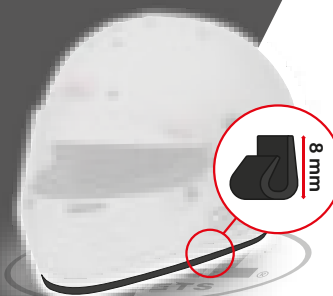

RUBBER PROFILE KIT TRIM EDGE THIN 1.7M

For All Glass shell Except Star Classic

BLACK **2090001** 20,00 €

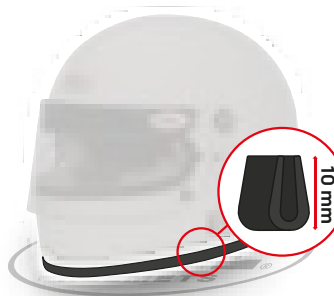

RUBBER PROFILE KIT STAR CLASSIC

For Star Classic

BLACK **2090002** 20,00 €

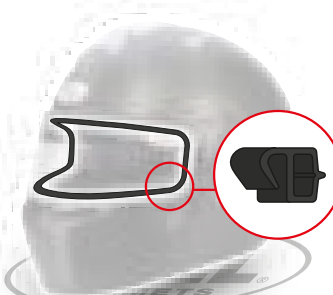

RUBBER PROFILE KIT VISOR EYEPPOINT EDGE 77CM

For All models

BLACK **2090011** 20,00 €

WHITE **2090050** 25,00 €



RUBBER PROFILE KIT TRIM EDGE ADVANCED 1M

For all Carbon shell + HP + HCB & FCB

BLACK **2090031** 20,00 €

WHITE **2090033** 25,00 €



RUBBER PROFILE KIT TRIM EDGE 500-TX (V10) 1.4M

BLACK **2090061** 20,00 €



SEALING CHIN BAR COVER KIT RUBBER X-1

BLACK **2081828** 29,00 €

EYEPPOINT TAPE FOAM



EYEPPOINT TAPE FOAM

BLACK **2080002** 10,00 €

TOP PAD FOAM



TOP PAD 20MM

SIZE 57-59 **2081644** 13,00 €

SIZE 60-61+ **2081645** 13,00 €





NEW

LARGE TROLLEY

- Lightweight and durable fabric
- Double closure with padlock-ready zipper
- Resistant cargo wheels
- Double handle on front and practical upper handle
- Multiple internal storage compartments
- Removable padded divider to store helmet or anything else
- Rigid bottom with standing support
- Coverable air net insert
- Dimensions: 42 x 36 x 92 cm
- Capacity: 145LT

2120025 150,00 €



NEW

SMALL TROLLEY

- Lightweight and durable fabric
- Double closure with padlock-ready zipper
- Resistant cargo wheels
- Double handle on front and practical upper handle
- Multiple internal storage compartment and pockets
- Rigid bottom with standing support
- Coverable air net insert
- Expansion system to gain more capacity
- Dimensions: 36 x 25 x 56 cm
- Capacity: 22LT / 32 LT expanded

2120024 105,00 €

BACKPACK

- Lightweight and durable fabric
- Double closure with padlock-ready zipper
- Padded notebook compartment
- Upper handle
- Multiple internal storage pockets
- Upper quick access pocket for documents
- Side water bottle pocket
- Comfortable shaped shoulder straps
- Dimensions: 32 x 24 x 50 cm
- Capacity: 20LT

2120026 80,00 €



NEW

MEDIUM TROLLEY

- Lightweight and durable fabric
- Double closure with padlock-ready zipper
- Resistant cargo wheels
- Double handle on front and practical upper handle
- Multiple internal storage compartments
- Removable padded divider to store helmet or anything else
- Rigid bottom with standing support
- Coverable air net insert
- Dimensions: 38 x 33 x 70 cm
- Capacity: 86LT

2120027 130,00 €



MEDIUM TROLLEY TRAVEL BAG BLACK QUILTED

- Lightweight and durable fabric
- Resistant cargo wheels
- Multiple internal storage compartments
- Rigid bottom with standing support
- Dimensions: 34 x 33 x 70 cm
- Capacity: 84LT

2120004 135,00 €



HP HELMET BAG

- Lightweight and durable fabric
- Protective lining
- Zipped side pockets
- Integrated strap to attached to a trolley bag handle for easy transport.
- Dimensions: 38 x 29 x 27 cm

2120001 60,00 €



HELMET & HANS BAG BLACK QUILTED

- Lightweight and durable fabric
- Protective lining
- Storage of helmet and Hans device
- Zipped side pockets
- Rigid bottom case
- Dimensions: 42 x 40 x 33 cm

2120002 85,00 €



HELMET & GEAR BAG

- Lightweight and durable fabric
- Protective lining
- Storage of helmet, Hans device and a few other accessories
- 3 zipped external storage pockets
- Dimensions: 41 x 56 x 36 cm

2120003 100,00 €



DRAWSTRING HELMET BAG

- Plush fleece lined helmet bag
- Dimensions: 44 x 31 x 30 cm

2120011 13,00 €

DRAWSTRING HELMET BAG

2120023 15,00 €

DRAWSTRING MICRO FIBER HELMET BAG V21



LARGE TROLLEY GEAR BAG BLACK QUILTED

- Lightweight and durable fabric
- Resistant cargo wheels
- Multiple internal storage compartments
- Removable hard case to protect the helmet when travelling
- Rigid bottom with standing support
- Dimensions: 38 x 36 x 93 cm
- Capacity: 144LT

2120005 175,00 €

BELL T-SHIRT GREY 6400 SPORT

2130221 to 2130225 30,00 €

LIGHT GREY SML-MED-LRG-XLG-2XL



BELL T-SHIRT DARK 8000 HEATHER

2130241 to 2130245 30,00 €

DARK GREY SML-MED-LRG-XLG-2XL

BELL HOODIE BLACK SS4500

2130261 to 2130265 45,00 €

BLACK SML-MED-LRG-XLG-2XL



BELL T-SHIRT ASH 8000

2130231 to 2130235 30,00 €

LIGHT GREY SML-MED-LRG-XLG-2XL



BELL T-SHIRT GUN METAL 67000

2130251 to 2130255 30,00 €

MEDIUM GREY SML-MED-LRG-XLG-2XL



BELL T-SHIRT BLACK W/BELL LOGO

2130211 to 2130215 30,00 €

BLACK SML-MED-LRG-XLG-2XL



BELL HOODIE FOREST CAMO SS4500

2130271 to 2130275 45,00 €

CAMO SML-MED-LRG-XLG-2XL



BELL CAP FLEXFIT S/M

2130011 to 2130012 30,00 €

BLACK S/M-L/XL



BELL CAP ADJUSTABLE

2130001 30,00 €

BLACK

1954



FACTORY CUSTOM PAINTING SERVICE

Bell Racing offers factory custom painting with the guarantee that the painting will not affect the original protective qualities of the helmet. Each painted helmet comes with an official certificate, proving its conformity with the FIA safety regulations.

Our experience over the past years in painting the helmets of F1 and other professional drivers enables us to reproduce almost every possible design and colours.

PAINTING JOB LEVEL 1	2170031	740,00 € *
PAINTING JOB LEVEL 2	2170032	1.110,00 € *
PAINTING JOB LEVEL 3	2170033	1.480,00 € *
PAINTING JOB LEVEL 4	2170034	1.850,00 € *
GRAPHICS DEVELOPMENT DESIGN ONE VIEW	2170011	120,00 € *
GRAPHICS DEVELOPMENT DESIGN FULL VIEW	2170011	320,00 € *
GRAPHICS DEVELOPMENT AMENDMENT (PER UNIT/PER AMENDMENT)	2170011	50,00 € *
ADDITIONAL CHARGE CHROME	2170035	260,00 € *
ADDITIONAL CHARGE PAINT SPOILER/PEAK	2170038	120,00 € *
ADDITIONAL CHARGE PAINT AIR INTAKE/SIDE COVERS	2170039	65,00 € *
ADDITIONAL CHARGE CHROME SPOILER/PEAK	2170040	65,00 € *
ADDITIONAL CHARGE CHROME AIR INTAKE/SIDE COVERS	2170041	40,00 € *
ADDITIONAL CHARGE USED HELMET	2170043	90,00 € *



OTHER SERVICES

INTERIOR FULL KIT REBUILD SERVICE CHARGE (Complimentary to SKU 218xxxx)	2170006	95,00 € *
INTERIOR KIT ASSEMBLY CHARGE (After painted shell)	2170050	215,00 € *
REPLACEMENT SERVICE BELL HELMET (Hans post anchor-drinking tube-chinstrap-radio kit)	2170084	30,00 € *

* Reduced discount

SIZING CHART

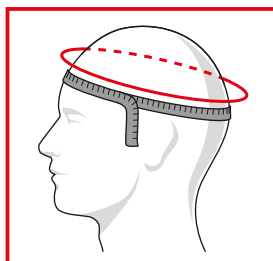

Metric Size	52	53	54	55	56	57	58	59	60	61	61+	63	64	65	66	67	68
Generic Size	3XS	XXS	XSM	SML	MED	LRG	XLG	2XLG	3XLG	4XLG							
Hat Size	6 1/2 - 6 5/8	6 3/4 - 6 7/8	7	7 1/8 - 7 1/4	7 1/4 - 7 3/8	7 1/2	7 5/8 - 7 3/4	7 7/8 - 8	8 1/8 - 8 1/4	8 3/8 - 8 1/2							

HOW TO FIT A HELMET

1. POSITIONING THE HELMET ON YOUR HEAD

Put the helmet on by grasping the chin strap halves in each hand and pull the helmet on over your head.

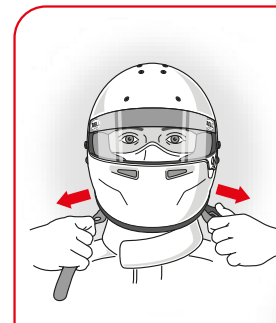

2. FITTING THE HELMET

When properly positioned, the helmet should be worn low on the brow eyes, near the center of the eye opening, touching the top of the head with uniform and firm pressure all around – tight without excessive pressure points.

To fasten the chin strap, thread the end of the strap through both d-rings, loop the strap end back through the inner d-ring and pull it comfortably tight against the throat. Make sure the chin strap is snug against the throat.

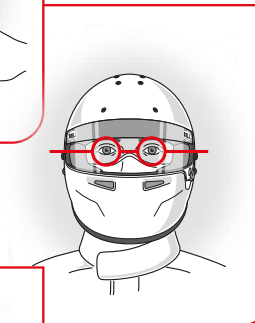

⚠ WARNING CORRECTLY USING THE CHIN STRAP

A good fit and a properly fastened chin strap are all that keep the helmet on your head during an accident. Make sure the chin strap is correctly fastened and pulled snugly up against your throat each time you wear your helmet.

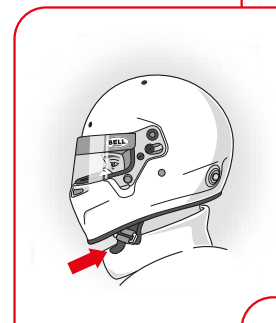

3. CHECKING THE FIT

Correctly position the helmet on your head and stand in front of a mirror. Gently rotate the helmet first from left to right and then from front to back. If the skin on your brow moves with the helmet as it is rotated, the fit is proper. If the skin on your brow does not move when the helmet is rotated in either direction, the fit is too loose. Try various sizes until you find one that fits correctly. With the helmet properly positioned, and the chin strap fastened, try to remove the helmet from your head. Grasp it securely and make a serious effort to roll it off your head in both the forward and backward directions. If you can remove the helmet or are able to roll the helmet backward far enough to expose your forehead or forward far enough to block your vision, the helmet either fits too loosely or the straps are not properly adjusted.

If the helmet is too large or if you can still remove the helmet, DO NOT use it and replace with a smaller size.

Repeat steps 1 through 3

If you cannot remove the helmet and it does not roll either backward far enough to expose your forehead or forward far enough to block your vision, you have a proper fit. We recommend fitting the helmet with a head sock or balaclava if you intend to wear one in competition.

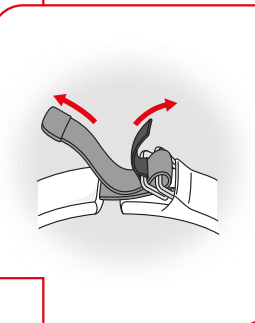

4. TEST DRIVE

Steps 1 through 3 are critical to getting the most out of your helmet. Spend as much time as necessary to satisfy yourself that you have a good fit. Only after successfully completing steps 1 through 3, put on your helmet and wear it for an extended period or take a test drive. If the helmet feels comfortable, remaining firmly in place and the straps remained properly adjusted, your helmet is ready to use. If the helmet feels uncomfortable or moves excessively, go through steps 1 through 3 as necessary to correct the problem. If you are unable to successfully complete all 3 steps, or if the helmet does not fit and feel comfortable, DO NOT continue to use the helmet. Either: Return to the dealer for assistance, or contact Bell Racing for further instructions.

Do not use chin cups or wear the strap on the point of the chin. This will increase the risk of the helmet coming off in an accident.

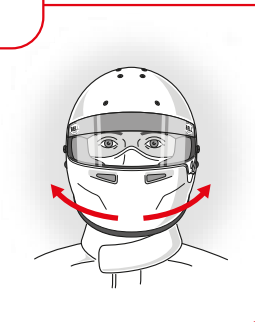
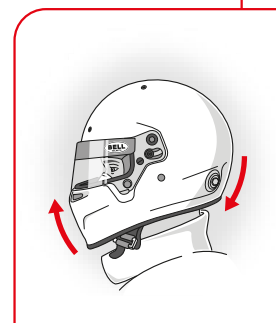

MORE INFO AT
WWW.BELLRACING.COM



Zeronoise features the most advanced communication systems in WRC. With its adaptive sound technology ZN is able to deal with any car, surface and driver's preference. This technology translates into a full product range of intercoms and full integration with Bell and OMP helmets.

The integration of ZN with OMP and Bell, delivers top performances thanks to the combined effort of the R&D departments. This approach led to breakthrough innovations such as the one today known as the Driver's Eye, the smallest camera in the world for live TV broadcasting, FIA homologated, that brings the driver's POV to the audience.

THIERRY NEUVILLE - HYUNDAI TEAM

COMMUNICATION DEVICES

ZERONoise

The Rally Systems enable communication between driver and co-driver with extensive Power and Noise Cancelling. They also feature radio, Bluetooth, and Car camera connection.

COMPONENTS

- Amplifiers
- Helmet radio kits
- Headsets
- Extensions and adaptors (if needed for different connector systems, e.g. components produced by other manufacturers)

SYSTEM ARCHITECTURE

Male 4 pin nexus connector on amplifier, female 4 pin nexus connector on helmet or headset.

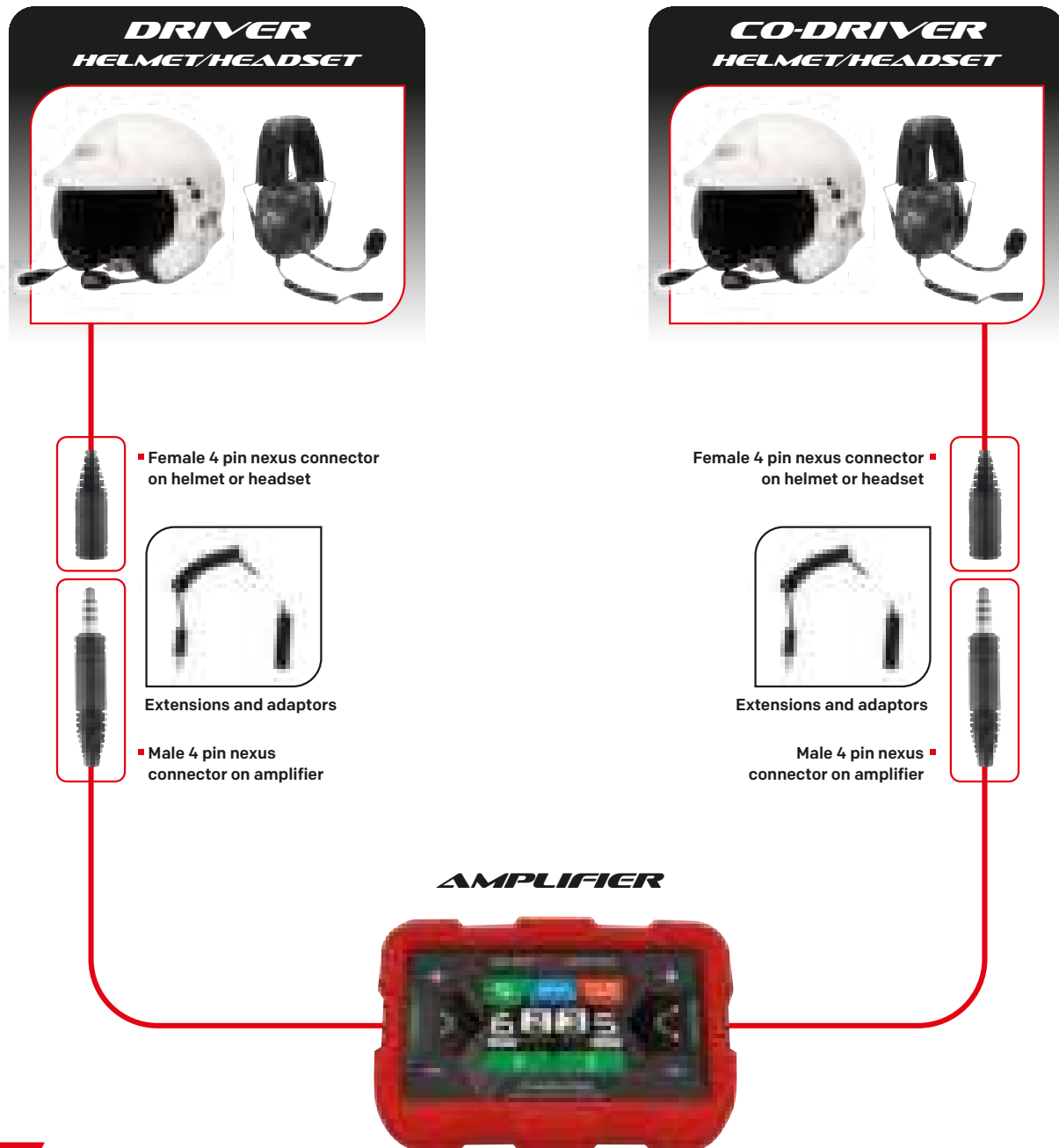

COMMUNICATION SYSTEM

The Circuit Systems enable communication between the car and the pit with a standard phone call, through a professional intercom system connected via bluetooth to the smartphone, as well as in-car communication between driver and co-driver/instructor. PIT LINK allows you to connect up to two people in the car, as well as more cars and more people at the pit by using the conference call feature of the smartphone.

COMPONENTS

- Pit link GSM amplifier
- Helmet radio kits
- Headsets for driver or co driver
- Extensions and adaptors (if needed for different connector systems, e.g. components produced by other manufacturers)
- Pit Link headset for the pit crew
- PTT button for call

SYSTEM ARCHITECTURE

Female 4 pin nexus connector on amplifier, male 4 pin nexus connector on helmet or headset.

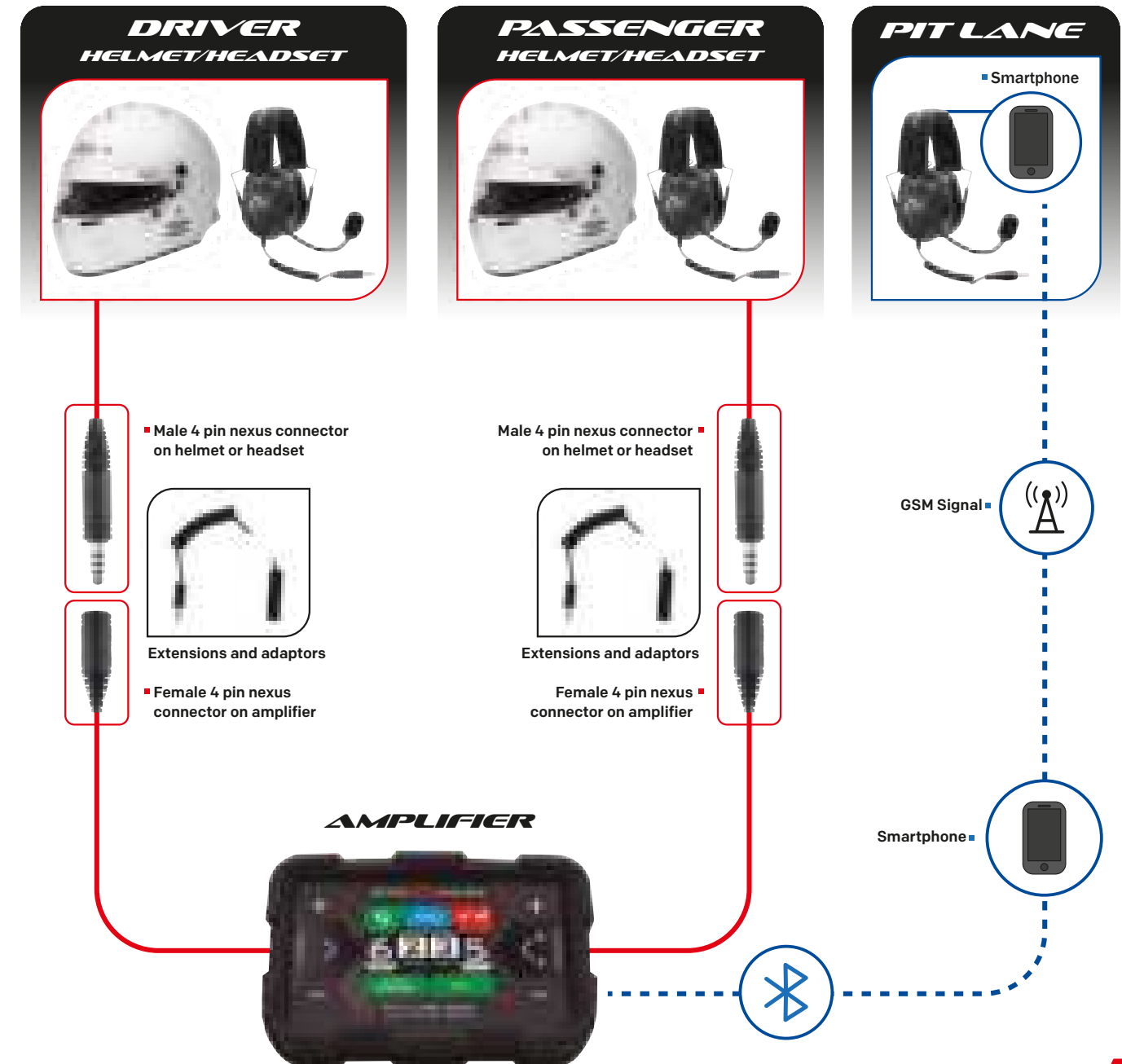

The Wired-Wireless (WW) System enables communication between driver and co-driver both in Wired and Wireless mode. When the helmet IS connected to the amplifier via cable, the communication works traditionally, also keeping compatibility with any Nexus communication system.

COMPONENTS

- WW Zeronoise Amplifier
- WW Bell Helmet radio kits / Helmet radio kits produced by other manufacturers
- WW Zeronoise Headsets / Headsets produced by other manufacturers
- Extensions and adaptors (if needed for different connector systems, e.g. components produced by other manufacturers)

SYSTEM ARCHITECTURE

Male 4 pin nexus connector on amplifier, female 4 pin nexus connector on helmet or headset.



When the helmet IS NOT connected to the amplifier via cable, the system switches automatically to the wireless mode with no interruption whatsoever.

COMPONENTS

- WW Zeronoise Amplifier
- WW Bell Helmet radio kits
- WW Zeronoise Headsets

SYSTEM ARCHITECTURE

Wireless connection.



THE WW SYSTEM MAINTAINS COMPATIBILITY WITH ANY NEXUS COMMUNICATION SYSTEM



FEARLESS WW is the revolutionary Zeronoise amplifier that combines wired and wireless communication using the ZN adaptive noise cancelling algorithm. The system ensures a smooth transition between wired and wireless mode as the intercom automatically switches to the most efficient way to manage the communication between driver and co-driver, inside and outside the car.

The amplifier display shows all relevant information: battery level, connection status, sound settings and more. It works wirelessly with selected models of Bell Rally helmets, but it is fully compatible with any helmet in the market that features a standard Nexus connector. The military grade technology on which Fearless Wireless is based, makes sure all communications are encrypted, reliable, and able to work in any environment.

- WIRED and WIRELESS communication
- Adaptive Noise Cancelling
- Multifunction touch display (It works with gloves)
- Bluetooth
- Anti shock, anti vibration silicon cover
- USB-C Port
- Audio Out for car camera
- Audio IN/OUT radio connection
- Dual volume adjustment
- 12V Filtered power cable
- Easy fix system on roll bar or dashboard
- Male 4 PIN Nexus



NEW FEARLESS WW



FIXING BRACKET

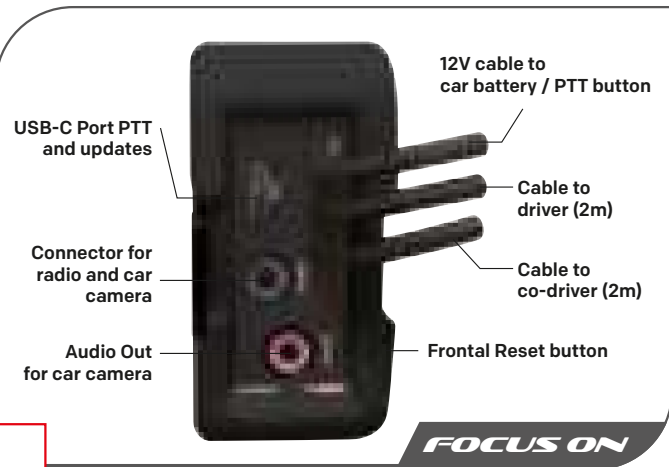

FOCUS ON



Male 4 PIN Nexus connector

FEARLESS WW MAINTAINS COMPATIBILITY WITH ANY NEXUS HELMET / HEADSET

ZERONOISE WW HEADSET provides high hearing protection while being comfortable and lightweight. It integrates the WW technology, therefore it works both in Wired and Wireless mode.

The high efficiency speakers are suitable for a conversation or listening to music. It also features a dynamic noise cancelling microphone and an adjustable flex boom.

It is fully compatible with all ZERONOISE AMPLIFIERS.



NEW

- Integrated WW technology
- High efficiency speakers for music or voice
- Dynamic noise cancelling microphone Flex boom to adjust microphone
- High hearing protection
- Soft adjustable headband
- Optional cable available only Female 4 PIN Nexus version



ZN HEADSET WW MAINTAINS COMPATIBILITY WITH ANY NEXUS AMPLIFIER

Wiring for Headset WW
Female Nexus 4 PIN Connector

6200010 85,00 €



Wired/Wireless Helmet Unit
With female 4 PIN Nexus

6100042 370,00 €



Wired/Wireless Radio Kit 10 Series

6300036 199,00 €

PROFESSIONAL DIGITAL AMPLIFIER

FEARLESS WRC Can-Bus is a digital amplifier with an integrated digital back-up unit and CanBus connectivity for a full car integration. Through the car Can-Bus it is possible to set each and every parameter of the amplifier from the car and displays the values directly on the dashboard. The amplifier has Deutsch connectors.

FOR RALLY USE



**FEARLESS
WRC CANBUS**

AVAILABLE UPON REQUEST

WIRING

**FOR FEARLESS WRC
CANBUS AMPLIFIER**

Wires and Deutsch connectors from the Fearless WRC CanBus amplifier to the car.



AVAILABLE UPON REQUEST

NEXUS CONNECTOR

FEARLESS is the ZERONOISE DIGITAL amplifier with its unique adaptive noise cancelling algorithm and sound comfort. Today used by more than 50% of the drivers in WRC, the electronics, look, and usability, make it the finest digital intercom in the market. A state of the art digital processor performs the adaptive noise cancelling and further sound settings are available. The display, in combination with the multifunction buttons, makes FEARLESS intuitive to use. FEARLESS' modern design is enhanced by the anti shock and anti vibration silicon cover. It is compatible with any helmet intercom kit with Nexus connectors, although the system delivers best performances with the ZERONOISE intercom kit range. It is fully compatible with all ZERONOISE INTERCOMS KIT/HEADSET.

- Digital active noise filtering
- Multifunction touch display (It works with gloves)
- Bluetooth
- Anti shock, anti vibration silicon cover
- USB-C Port
- Audio Out for car camera
- Audio IN/OUT radio connection
- Dual volume adjustment
- 12V Filtered power cable
- Easy fix system on roll bar or dashboard
- Available with three different connectors:
 - Male 4 PIN Nexus
 - Female 4 PIN Nexus
 - Female 4 PIN Nexus (comp. IMSA)



FEARLESS

NEW RELEASE

INCREASED POWER OUTPUT
INCREASED POWER SUPPLY STABILISATION



FIXING BRACKET

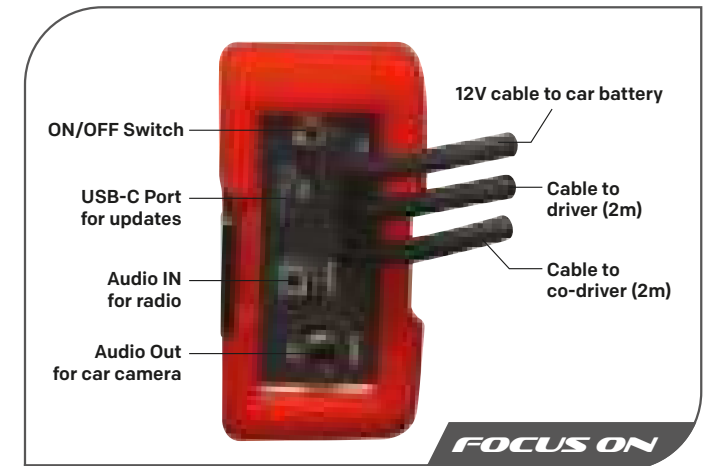

FOCUS ON

FEARLESS DIGITAL AMPLIFIER

6100008 428,00 €

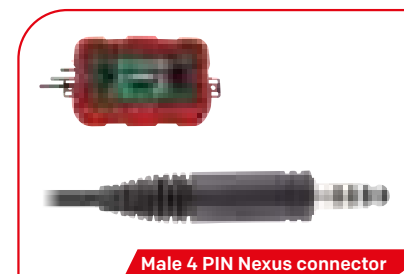

Male 4 PIN Nexus connector

FEARLESS DIGITAL AMPLIFIER

Connector: Female 4 PIN Nexus 6100009 428,00 €

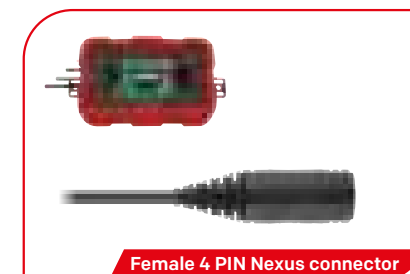

Female 4 PIN Nexus connector

FEARLESS DIGITAL AMPLIFIER

Connector: (comp. IMSA) Female 4 PIN Nexus 6100010 428,00 €

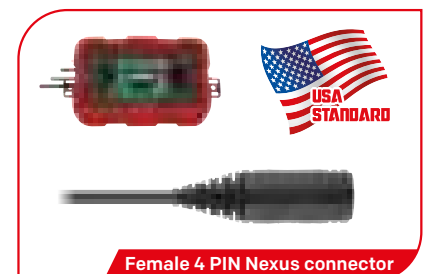

Female 4 PIN Nexus connector



FURY is the new digital amplifier that makes the incomparable quality of Zeronoise adaptive noise cancelling available to all drivers. FURY combines the digital sound quality with the simplicity of use. The four pre-set buttons had been carefully designed to refine the sound in any condition. They both work independently or combined.

Presets:

- **TERRAIN:** The noise cancelling algorithm focusses on the noises coming from the road surface.
- **BOOST:** It enhances the voice volume output for the most demanding drivers.
- **ENGINE:** This pre-set is effective on the noises coming from the engine.
- **ROAD/STAGE:** Stage mode turns off the radio output, so the communication is solely between drive and co-driver for maximum focus.

- Adaptive noise cancelling
- Anti shock, anti vibration silicon cover
- USB-C Port
- Audio Out for car camera
- Audio IN/OUT radio connection
- Dual volume adjustment
- 12V Filtered power cable
- Easy fix system on roll bar or dashboard
- Available with three different connectors:
 - Male 4 PIN Nexus
 - Female 4 PIN Nexus
 - Female 4 PIN Nexus (comp. IMSA)



NEW

FURY



FIXING BRACKET

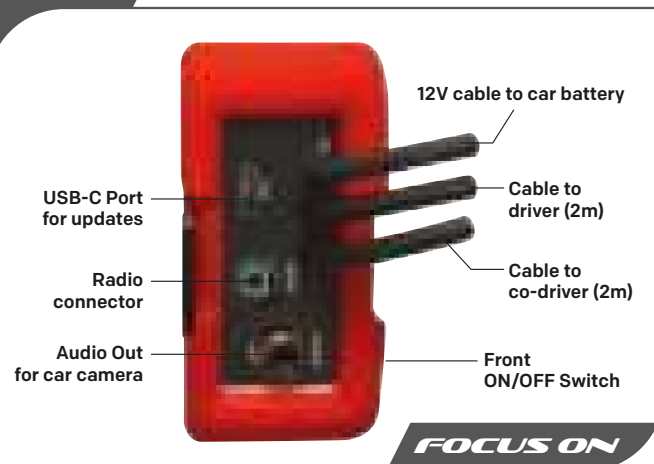

FOCUS ON

FURY DIGITAL AMPLIFIER

Connector: Male 4 PIN Nexus **6100038** 285,00 €

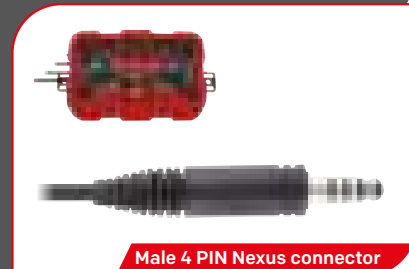

Male 4 PIN Nexus connector

FURY DIGITAL AMPLIFIER

Connector: Female 4 PIN Nexus **6100039** 285,00 €

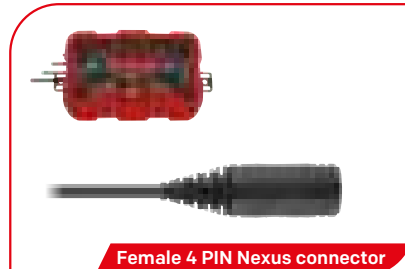

Female 4 PIN Nexus connector

FURY DIGITAL AMPLIFIER

Connector: (comp. IMSA) Female 4 PIN Nexus **6100040** 285,00 €



Female 4 PIN Nexus connector

Text BoxBRAVE is ZERONoise analog amplifier with a unique value for money. Its brand new amplification delivers a clean sound with the likes of professional intercoms and endless power. It also features a 12v power cable to connect BRAVE to the car battery and a car camera RCA socket. It is fully compatible with all ZERONoise INTERCOM KITS/HEADSETS.

- Analog noise filter
- Efficient amplification for long battery life
- Anti shock, anti vibration silicon cover
- Dual volume adjustment
- ON/OFF led light
- Audio Out for car camera
- 9V Internal battery and 12V power cable
- Easy fix system on roll bar or dashboard
- Available with three different connectors:
 - Male 4 PIN Nexus
 - Female 4 PIN Nexus
 - Female 4 PIN Nexus (comp. IMSA)



NEW RELEASE

**INCREASED POWER OUTPUT
INCREASED POWER SUPPLY STABILISATION**



FIXING BRACKET

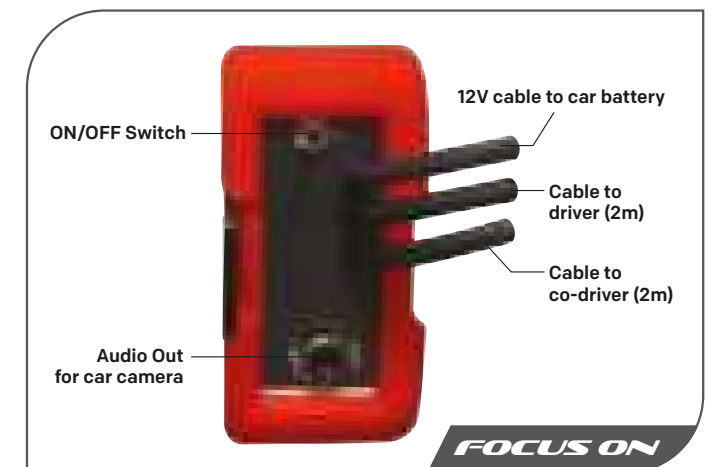

FOCUS ON

BRAVE ANALOG AMPLIFIER

6100002 183,00 €

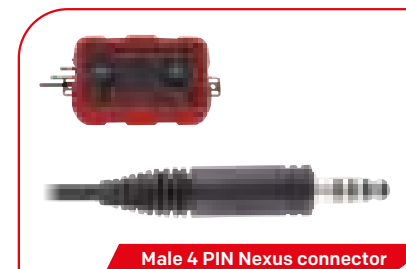

Male 4 PIN Nexus connector

BRAVE ANALOG AMPLIFIER

Connector: Female 4 PIN Nexus **6100003** 183,00 €

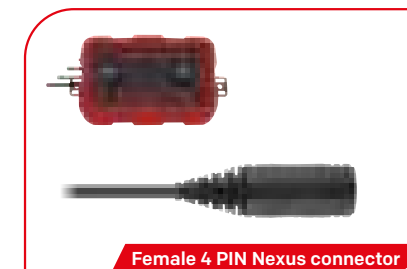

Female 4 PIN Nexus connector

BRAVE ANALOG AMPLIFIER

Connector: (comp. IMSA) Female 4 PIN Nexus **6100004** 183,00 €

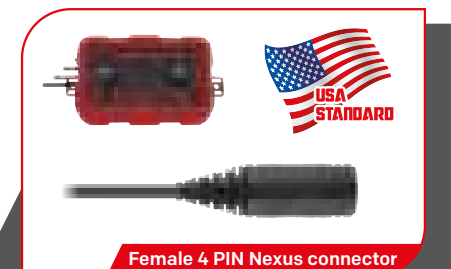

Female 4 PIN Nexus connector



ZERONOISE HEADSET provides high hearing protection while being comfortable and lightweight. The high efficiency speakers are suitable for a conversation or listening to music. It also features a dynamic noise cancelling microphone and an adjustable flex boom. It is fully compatible with all ZERONOISE AMPLIFIERS.

- High efficiency speakers for music or voice
- Dynamic noise cancelling microphone
- Flex boom to adjust microphone
- High hearing protection
- Soft auto adjustable headband
- Comfortable earpads
- Coiled cable
- Available with three different connectors:
 - Male 4 PIN Nexus
 - Female 4 PIN Nexus
 - Female 4 PIN Nexus (comp. IMSA)

NEW RELEASE



ZERONOISE HEADSET

Connector: Female 4 PIN Nexus **6200002** 190,00 €

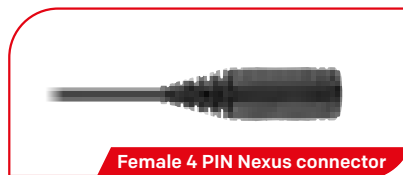

ZERONOISE HEADSET

Connector: Male 4 PIN Nexus **6200003** 190,00 €

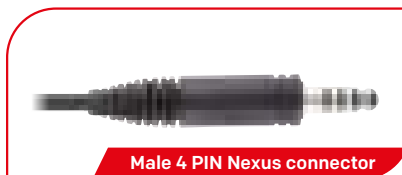

ZERONOISE HEADSET

Connector: (comp. IMSA) Male 4 PIN Nexus **6200004** 190,00 €



EARCUPS

EARCUPS WITH SPEAKERS

Connector: RCA Male CINCINCH CONNECTOR **6300034** 79,00 €

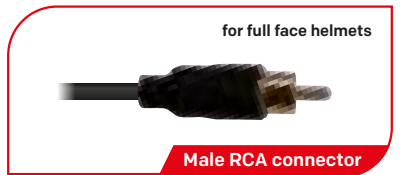

EARCUPS WITH SPEAKERS

Connector: 3.5mm STEREO PLUG **6300035** 79,00 €



The new ZN PRO EARPLUGS feature a super soft, very comfortable silicone moulded shape that easily adapts to any ear.

The speaker is mounted in the ear canal that can be short or long, depending on the ear shape and personal preferences.



Semicustom earplugs with short ear canal and cleaning kit (3.5mm Male Connector)
6300028 220,00 €



Semicustom earplugs with long ear canal and cleaning kit (3.5mm Male Connector)
6300029 220,00 €

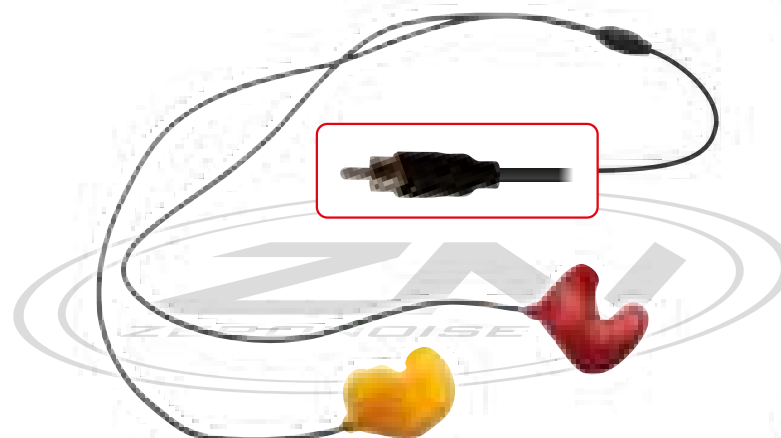

Semicustom earplugs with short ear canal and cleaning kit (RCA Male Connector)
6300031 220,00 €



Semicustom earplugs with long ear canal and cleaning kit (RCA Male Connector)
6300032 220,00 €

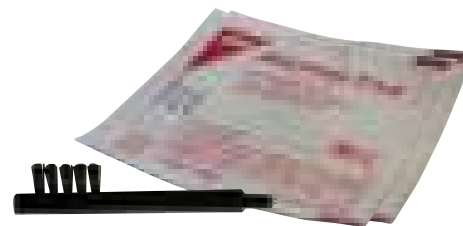

■ Cleaning kit included

 Text Box Bluetooth Digital Amplifier that allows professional communication between two people in the car and the pit at the same time through Bluetooth smartphone connection. Noise and voice can be digitally set to fine-tune noise cancelling and voice. Communication can open up automatically or via PTT button.

- Digital Noise Filters and Voice Equalisation
- Multifunction Touch Display
- Nexus connectors, L=2m cables
- Car Camera Audio output (RCA)
- Anti shock, anti vibration black rugged silicon cover
- Integrated PTT Button
- Dual volume adjustment
- Car battery cable 12V.
- Software updates through USB-C port
- Easy fix system on roll bar or dashboard
- Available with three different connectors:
 - Male 4 PIN Nexus
 - Female 4 PIN Nexus
 - Female 4 PIN Nexus (comp. IMSA)



PIT-LINK GSM

NEW RELEASE

INCREASED POWER OUTPUT
INCREASED POWER SUPPLY STABILISATION



FIXING BRACKET



- ADDITIONAL PTT BUTTON**
- SINGLE PTT BUTTON WITH USB-C CONNECTOR**
Ength 2m **6100013** 28,00 €
- DOUBLE PTT BUTTON WITH USB-C CONNECTOR**
For driver and co-driver
Ength 2m **6100014** 56,00 €

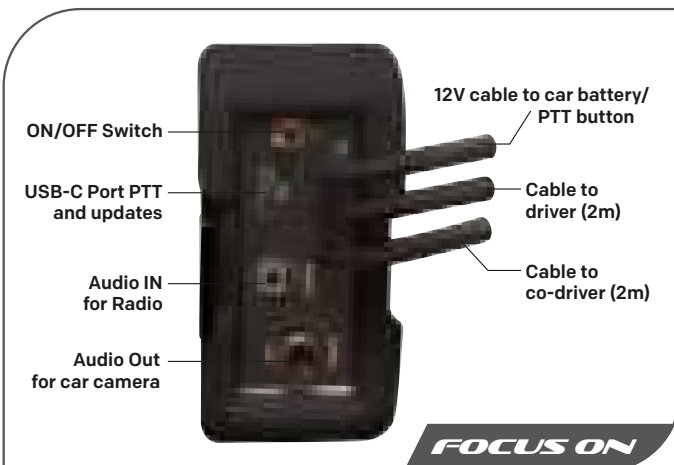

FOCUS ON

DIGITAL PIT-LINK GSM AMPLIFIER

Connector: Male 4 PIN Nexus **6100026** 510,00 €



Male 4 PIN Nexus connector

DIGITAL PIT-LINK GSM AMPLIFIER

Connector: Female 4 PIN Nexus **6100027** 510,00 €

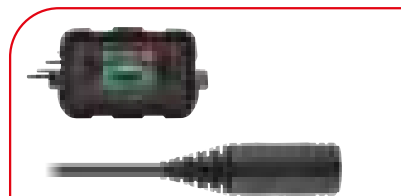

Female 4 PIN Nexus connector

DIGITAL PIT-LINK GSM AMPLIFIER

Connector: (comp. IMSA) Female 4 PIN Nexus **6100028** 510,00 €

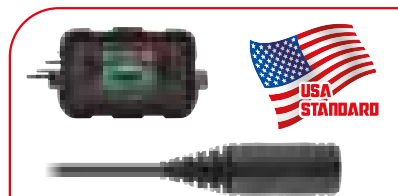

Female 4 PIN Nexus connector

PIT-LINK HEADSET provides high hearing protection while being comfortable and lightweight. It is ideal to be used at the pit thanks to the dynamic noise cancelling microphone and an adjustable flex boom, and PTT button

It is fully compatible with all ZERONOISE AMPLIFIERS.



- Professional Headset with Noise cancelling
- Microphone Jack 3.5mm connector for smartphone.
- PTT Button

HEADSET ANDROID COMPATIBLE

Jack 3.5mm- Smartphone comp. WITH PTT BUTTON ANDROID compatible **6200005** 269,00 €



Microphone jack 3.5mm connector

HEADSET iPHONE COMPATIBLE

Jack 3.5mm- Smartphone comp. WITH PTT BUTTON iPHONE compatible **6200006** 269,00 €



Microphone jack 3.5mm connector

NEW RELEASE

GO WIRELESS WITH YOUR HEADSET WITH PIT-LINK TRAINER HEADSET AND AMPLIFIER (PAGE 110)

EARPLUGS KIT



EARPLUGS KIT

Earplugs kit with foam tips 3.5mm Male Connector **6300030** 158,00 €



3.5mm Male connector

Earplugs kit with foam tips RCA Male Connector **6300033** 158,00 €



RCA Male connector

STEREO CONNECTOR

VALIANT is the entry level analog amplifier of ZERONoise. It is easy to use, solid and straightforward, a good choice for amateurs and beginners. It is powered by the internal 9v battery, or the 12v power cable that connects VALIANT directly to the car battery. It also features 6.35mm connectors and car camera RCA socket for audio output.

- Analog noise filter
- Efficient amplification for long battery life
- Anti shock, anti vibration silicon cover
- Dual volume adjustment
- ON/OFF led light
- Audio Out for car camera
- 9V Internal battery and 12V power cable
- Easy fix system on roll bar or dashboard
- 6.35mm Stereo Connectors



VALIANT

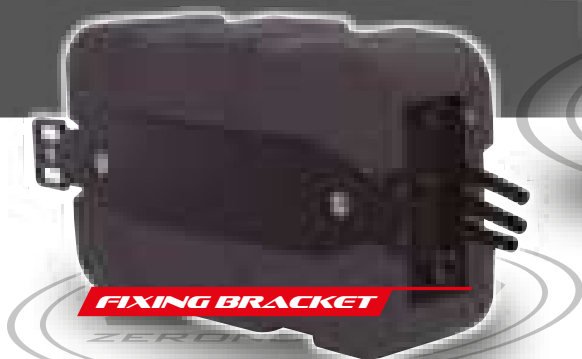

FIXING BRACKET



Female 6.35mm Stereo connectors

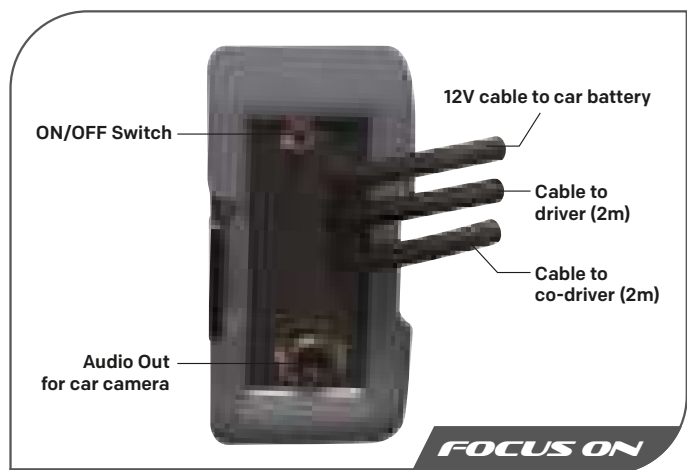

FOCUS ON

VALIANT HEADSET

6200001

STEREO CONNECTOR

140,00 €



Male 6.35mm Stereo connector

- with Electret Noise Cancelling microphone,
- Male Jack 6.35mm STEREO connector and coiled cable.

SILICONE COVER

Heavy duty silicone cover anti shock and anti vibration. Available in smooth or rugged version.

SMOOTH SILICONE COVER

Red Smooth **6100018** 22,00 €



RUGGED SILICONE COVER

28,00 €

Red Rugged **6100019** Black Rugged **6100030** Grey Rugged **6100035**



RADIO ADAPTORS

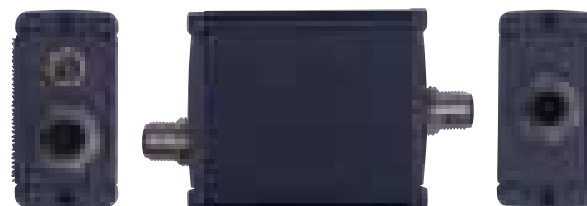

COMPATIBLE WITH Amplifier: FURY, FEARLESS, FEARLESS WW

BOX RADIO ADAPTER

6400025 175,00 €

BOX RADIO ADAPTER + POWER FILTER

6400026 235,00 €

SOUND FILTER

6400017

42,00 €

12V Power Filter works between the intercom and the 12V power source. It filters audio signal and minimises interferences.

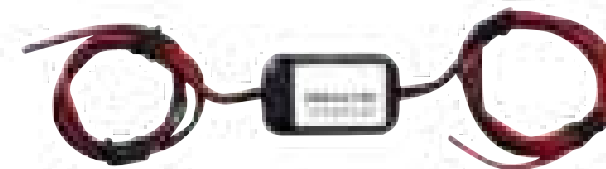

REPLACEMENT TIPS

6400019

Replacement foam tips for earplugs.

6,00 €

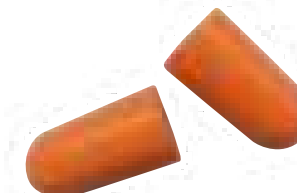

COMPATIBLE WITH ALL Amplifiers

BOX POWER FILTER MY2024

6400027 85,00 €

REPLACEMENT MICROPHONE FOAM COVER

6400024

Replacement for Headset and RHK Jet Version.

5,00 €



PIT-LINK TRAINER SYSTEM ARCHITECTURE

PIT-LINK TRAINER is a simple and straightforward way to enable communication between the driver and the pit.

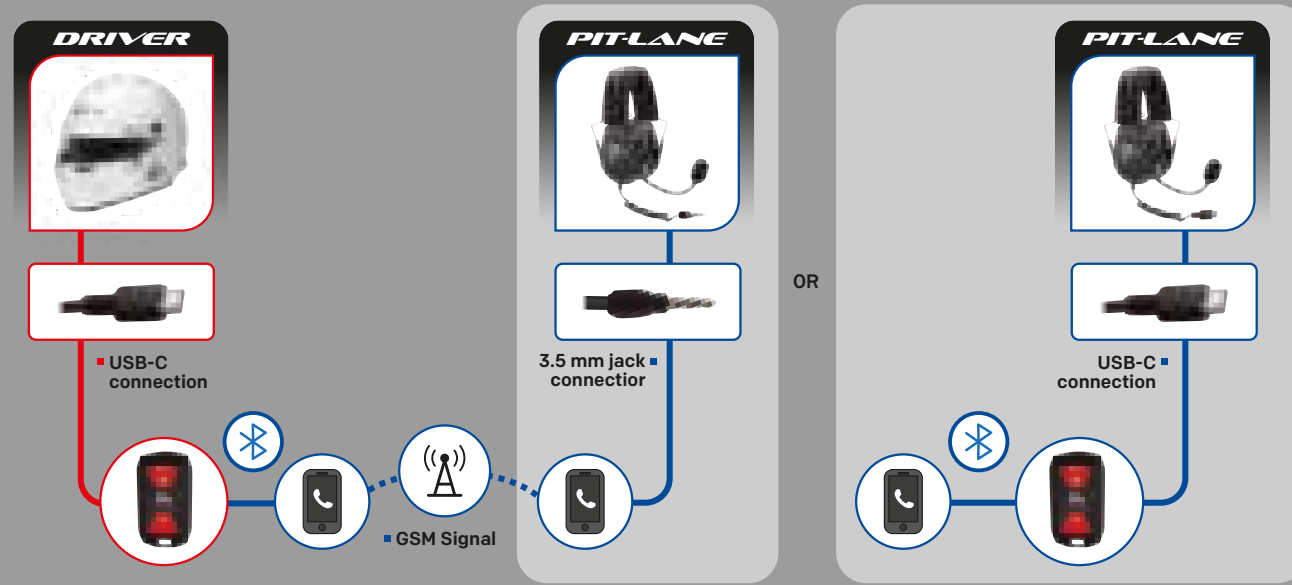

WEARABLE AMPLIFIER

6100031

158,00 €

- Micro Amplifier
- Super Fast Bluetooth
- Advanced Noise cancelling
- USB Port (Type C) for recharging
- Independent volume
- Long life rechargeable Internal battery



PIT-LINK TRAINER is the micro amplifier designed to be the perfect communication tool for karting. PIT-LINK TRAINER is a Bluetooth Digital Amplifier that allows to communicate with the pit during a training session. You can wear it around your neck and keep it inside your suit. The digital noise cancelling makes the communication smooth by reducing the noise around the driver.

Communication is automatically on when the phone call is incoming. No need to press anything. The pit crew will connect to the driver through a normal phone call. PIT-LINK TRAINER requires PIT-LINK MICROPHONE KIT and PIT-LINK EARPLUGS to be setup in the helmet.

EARPLUGS KIT

6300021

158,00 €

- Earplugs with smartphone male jack 3.5mm connector.
- Spare set of Super Soft Foam Tips.
- Metal case.



USB-C MICROPHONE KIT

6300026

131,00 €

- Radio helmet kit for full face helmet - USB-C connector for pit-link trainer.
- With 3.5mm stereo connector for earplugs.

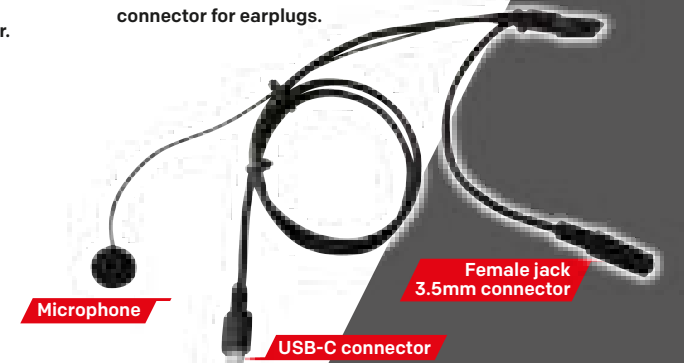

AMPLIFIER-KART PRO KIT DRIVER AND PIT LANE

- Wearable amplifier, professional headset, USB microphone radio kit and professional earplugs

WITH USB-C WEARABLE AMPLIFIER COMPATIBLE HEADSET

6100024 597,00 €

KIT WITH ANDROID COMPATIBLE HEADSET

6100032 522,00 €

KIT WITH IPHONE COMPATIBLE HEADSET

6100034 522,00 €

the kit includes 2 amplifier: one for driver, one for pit



Wearable amplifier

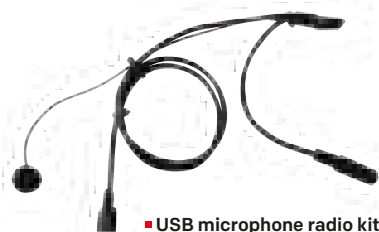

USB microphone radio kit



Professional earplugs



AMPLIFIER-KART BASIC KIT DRIVER

- Wearable amplifier, USB microphone radio kit and professional earplugs.

312,00 € 6100033



Wearable amplifier



USB microphone radio kit



Professional earplugs



PIT HEADSET

6200005 to 6200007

269,00 € to 350,00 €

- Professional Headset with Noise cancelling
- Microphone Jack 3.5mm connector for smartphone.
- PTT Button



HEADSET ANDROID COMPATIBLE

Jack 3.5mm- Smartphone comp. WITH PTT BUTTON - ANDROID compatible 6200005 269,00 €

HEADSET IPHONE COMPATIBLE



Jack 3.5mm- Smartphone comp. WITH PTT BUTTON - IPHONE compatible 6200006 269,00 €

All our radio kits in a single table. Here you can find all the radio kits we have developed for an optimised use with ZN amplifiers, and still compatible with the major competitors' products.

There are 8 models for open face helmets and 12 models for full face helmets: choose yours by





- CONNECTOR
- MICROPHONE
- SPEAKERS

Custom kit available upon request.

YOUR HELMET MODEL	PRICE	REFERENCE	CONNECTOR
 <p>Open face helmets</p>	199,00 €	6300001	FEMALE NEXUS 4 PIN
	79,00 €	6300002	FEMALE NEXUS 4 PIN
	199,00 €	6300003	FEMALE NEXUS 4 PIN
	199,00 €	6300004	MALE NEXUS 4 PIN
	83,00 €	6300005	MALE NEXUS 4 PIN
	199,00 €	6300006	IMSA NEXUS 4 PIN
	83,00 €	6300007	IMSA NEXUS 4 PIN
	35,00 €	6300008	MALE STEREO
 <p>Full face helmets</p>	179,00 €	6300024	MALE NEXUS 4 PIN
	179,00 €	6300025	MALE NEXUS 4 PIN
	199,00 €	6300009	MALE NEXUS 4 PIN
	83,00 €	6300010	MALE NEXUS 4 PIN
	179,00 €	6300011	MALE NEXUS 4 PIN
	179,00 €	6300012	MALE NEXUS 4 PIN
	199,00 €	6300013	MALE NEXUS 5 PIN
	199,00 €	6300014	IMSA NEXUS 4 PIN
	83,00 €	6300015	IMSA NEXUS 4 PIN
	179,00 €	6300016	IMSA NEXUS 4 PIN
	179,00 €	6300017	IMSA NEXUS 4 PIN
	199,00 €	6300018	MALE IMSA NEXUS 5 PIN
32,00 €	6300019	MALE STEREO	
131,00 €	6300026	USB-C FOR PIT LINK	
83,00 €	6300023	FEMALE NEXUS 4 PIN	
199,00 €	6300027	FEMALE NEXUS 4 PIN	
79,00 €	6300034	MALE RCA	
79,00 €	6300035	MALE STEREO	
199,00 €	6300036	MOLEX	

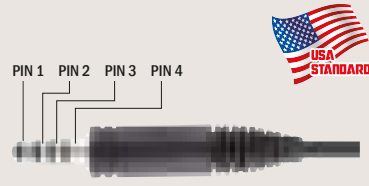
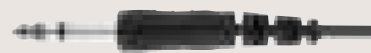
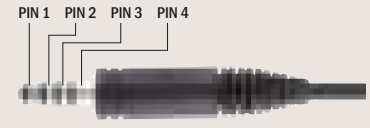
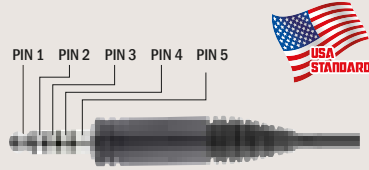
MICROPHONE FOR OPEN FACE		CONNECTOR FOR EARPLUGS		SPEAKERS	
BELL HCB COMPATIBLE	FLEX BOOM	RCA CONNECTOR	3,5mm CONNECTOR	EARCUPS	SPEAKER PADS
	✓			✓	
	✓				✓
✓				✓	
	✓			✓	
	✓				✓
	✓			✓	
	✓				✓
	✓				✓
		✓			
			✓		
		✓		✓	
			✓		✓
		✓			✓
			✓		✓
		✓			✓
		✓			✓
			✓		✓
				✓	
				✓	
				✓	
✓				✓	

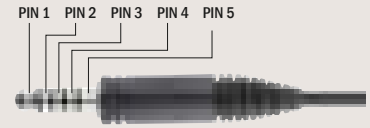
CONNECTORS

<p>MALE IMSA NEXUS 4 PIN</p>  <p>PIN 1 PIN 2 PIN 3 PIN 4</p> <p>USA STANDARD</p>	<p>MALE STEREO</p> 	<p>MALE NEXUS 4 PIN</p>  <p>PIN 1 PIN 2 PIN 3 PIN 4</p>
<p>MALE IMSA NEXUS 5 PIN</p>  <p>PIN 1 PIN 2 PIN 3 PIN 4 PIN 5</p> <p>USA STANDARD</p>	<p>USB-C FOR PIT-LINK</p> 	<p>MALE NEXUS 5 PIN</p>  <p>PIN 1 PIN 2 PIN 3 PIN 4 PIN 5</p>
	<p>FEMALE RCA</p> 	<p>FEMALE NEXUS 4 PIN</p> 

<p>MICROPHONE FOR OPEN FACE</p> <p>BELL HCB COMPATIBLE MICROPHONE</p> 	<p>CONNECTOR FOR EARPLUGS</p> <p>MICROPHONE KIT FOR EARPLUGS RCA CONNECTOR</p> 	<p>SPEAKERS</p> <p>EARCUPS</p> 
<p>MICROPHONE FOR OPEN FACE</p> <p>FLEX BOOM MICROPHONE</p> 	<p>CONNECTOR FOR EARPLUGS</p> <p>MICROPHONE KIT FOR EARPLUGS 3,5mm CONNECTOR</p> 	<p>SPEAKERS</p> <p>SPEAKER PADS</p> 

YOUR AMPLIFIER, INTERCOM, RADIO OR PHONE CONNECTOR		YOUR HELMET, HEADSET OR RADIO HELMET KIT CONNECTOR			
		STANDARD (EU)		IMSA (USA)	
		MALE NEXUS 4 PIN	FEMALE NEXUS 4 PIN	MALE NEXUS 5 PIN	MALE NEXUS 4 PIN
STANDARD (EU)	MALE NEXUS 4 PIN 	6400005	EXTENSION 6400006	MADE TO ORDER	6400008
	FEMALE NEXUS 4 PIN 	EXTENSION 6400006	6400004	MADE TO ORDER	6400009
	FEMALE NEXUS 5 PIN 	6400012	6400013	MADE TO ORDER	MADE TO ORDER
IMSA (USA)	FEMALE NEXUS 4 PIN 	6400009	6400007	MADE TO ORDER	MADE TO ORDER
	FEMALE NEXUS 5 PIN 	NA	NA	NA	6400014
	PHONE CONN. 3.5 mm 	6400010	6400011	MADE TO ORDER	MADE TO ORDER



FEARLESS WIRELESS AMPLIFIER

ADAPTORS some adaptors example

STANDARD (EU)						
REFERENCE	PRICE	ADAPTOR TYPE	CONNECTOR 1	CONNECTOR 2	CABLE TYPE	LENGHT
6400004	70,00 €	ADAPTOR	MALE NEXUS 4 PIN	MALE NEXUS 4 PIN	COILED CABLE CROSSED WIRING	15 cm
6400005	70,00 €	ADAPTOR	FEMALE NEXUS 4 PIN	FEMALE NEXUS 4 PIN	COILED CABLE CROSSED WIRING	15 cm
6400006	70,00 €	EXTENSION	MALE NEXUS 4 PIN	FEMALE NEXUS 4 PIN	COILED CABLE	150 cm
6400012	81,00 €	ADAPTOR	FEMALE NEXUS 4 PIN	MALE NEXUS 5 PIN	STRAIGHT CABLE	15 cm
6400013	81,00 €	ADAPTOR	MALE NEXUS 4 PIN	MALE NEXUS 5 PIN	STRAIGHT CABLE	15 cm
6400021	99,00 €	ADAPTOR EXTENSION	FEMALE NEXUS 4 PIN / RCA	MALE NEXUS 4 PIN	COILED CABLE	150 cm
6400022	99,00 €	ADAPTOR	MALE NEXUS 4 PIN / RCA	MALE NEXUS 4 PIN	COILED CABLE CROSSED WIRING	15 cm
6400023	99,00 €	ADAPTOR	FEMALE NEXUS 4 PIN / RCA	FEMALE NEXUS 4 PIN	COILED CABLE CROSSED WIRING	15 cm

IMSA (USA)						
REFERENCE	PRICE	ADAPTOR TYPE	CONNECTOR 1	CONNECTOR 2	CABLE TYPE	LENGHT
6400008	70,00 €	ADAPTOR	FEMALE NEXUS (IMSA) 4 PIN	FEMALE NEXUS 4 PIN	COILED CABLE CROSSED WIRING	15 cm
6400009	70,00 €	ADAPTOR	MALE NEXUS (IMSA) 4 PIN	FEMALE NEXUS 4 PIN	COILED CABLE CROSSED WIRING	15 cm
6400007	70,00 €	ADAPTOR	MALE NEXUS 4 PIN	MALE NEXUS (IMSA) 4 PIN	COILED CABLE CROSSED WIRING	15 cm
6400014	81,00 €	ADAPTOR	FEMALE NEXUS (IMSA) 4 PIN	MALE NEXUS (IMSA) 5 PIN	STRAIGHT CABLE	15 cm

STANDART SMARTPHONE						
REFERENCE	PRICE	ADAPTOR TYPE	CONNECTOR 1	CONNECTOR 2	CABLE TYPE	LENGHT
6400010	81,00 €	ADAPTOR	MALE NEXUS 4 PIN	JACK 3.5mm SMARTPHONE	STRAIGHT CABLE	50 cm
6400011	81,00 €	ADAPTOR	FEMALE NEXUS 4 PIN	JACK 3.5mm SMARTPHONE	STRAIGHT CABLE	50 cm



A. MIKKELSEN · T. ERIKSEN · SKODA FABIA RALLY2 TOKSPORT WRT

HELMETS

CIRCUIT

FULL FACE HELMETS

HP77

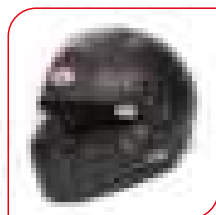

1128021	HP77 (HANS) 54(6 3/4) FIA8860-2018-ABP BELL HELMET	4.900,00 €
1128022	HP77 (HANS) 55(6 7/8) FIA8860-2018-ABP BELL HELMET	4.900,00 €
1128023	HP77 (HANS) 56(7) FIA8860-2018-ABP BELL HELMET	4.900,00 €
1128024	HP77 (HANS) 56+(7 +) FIA8860-2018-ABP BELL HELMET	4.900,00 €
1128026	HP77 (HANS) 57(7 1/8) FIA8860-2018-ABP BELL HELMET	4.900,00 €
1128027	HP77 (HANS) 58(7 1/4) FIA8860-2018-ABP BELL HELMET	4.900,00 €
1128028	HP77 (HANS) 59(7 3/8) FIA8860-2018-ABP BELL HELMET	4.900,00 €
1128029	HP77 (HANS) 59+(7 3/8 +) FIA8860-2018-ABP BELL HELMET	4.900,00 €

HP7 EVO-III



1101061	HP7 EVO-III (HANS) 54(6 3/4) FIA8860-2018 BELL HELMET	3.500,00 €
1101062	HP7 EVO-III (HANS) 55(6 7/8) FIA8860-2018 BELL HELMET	3.500,00 €
1101063	HP7 EVO-III (HANS) 56(7) FIA8860-2018 BELL HELMET	3.500,00 €
1101064	HP7 EVO-III (HANS) 56+(7 +) FIA8860-2018 BELL HELMET	3.500,00 €
1101066	HP7 EVO-III (HANS) 57(7 1/8) FIA8860-2018 BELL HELMET	3.500,00 €
1101067	HP7 EVO-III (HANS) 58(7 1/4) FIA8860-2018 BELL HELMET	3.500,00 €
1101068	HP7 EVO-III (HANS) 59(7 3/8) FIA8860-2018 BELL HELMET	3.500,00 €
1101069	HP7 EVO-III (HANS) 59+(7 3/8 +) FIA8860-2018 BELL HELMET	3.500,00 €
1101070	HP7 EVO-III (HANS) 60(7 1/2) FIA8860-2018 BELL HELMET	3.500,00 €
1101071	HP7 EVO-III (HANS) 61(7 5/8) FIA8860-2018 BELL HELMET	3.500,00 €
1101072	HP7 EVO-III (HANS) 61+(7 5/8 +) FIA8860-2018 BELL HELMET	3.500,00 €

HP7 EVO-III DUCKBILL



1101041	HP7 EVO-III DUCKBILL (HANS) 54(6 3/4) FIA8860-2018 BELL HELMET	3.500,00 €
1101042	HP7 EVO-III DUCKBILL (HANS) 55(6 7/8) FIA8860-2018 BELL HELMET	3.500,00 €
1101043	HP7 EVO-III DUCKBILL (HANS) 56(7) FIA8860-2018 BELL HELMET	3.500,00 €
1101044	HP7 EVO-III DUCKBILL (HANS) 56+(7 +) FIA8860-2018 BELL HELMET	3.500,00 €
1101046	HP7 EVO-III DUCKBILL (HANS) 57(7 1/8) FIA8860-2018 BELL HELMET	3.500,00 €
1101047	HP7 EVO-III DUCKBILL (HANS) 58(7 1/4) FIA8860-2018 BELL HELMET	3.500,00 €
1101048	HP7 EVO-III DUCKBILL (HANS) 59(7 3/8) FIA8860-2018 BELL HELMET	3.500,00 €
1101049	HP7 EVO-III DUCKBILL (HANS) 59+(7 3/8 +) FIA8860-2018 BELL HELMET	3.500,00 €
1101050	HP7 EVO-III DUCKBILL (HANS) 60(7 1/2) FIA8860-2018 BELL HELMET	3.500,00 €
1101051	HP7 EVO-III DUCKBILL (HANS) 61(7 5/8) FIA8860-2018 BELL HELMET	3.500,00 €
1101052	HP7 EVO-III DUCKBILL (HANS) 61+(7 5/8 +) FIA8860-2018 BELL HELMET	3.500,00 €

HP6



1140001	HP6 (HANS) 54(6 3/4) FIA8860-2018 BELL HELMET	2.100,00 €
1140002	HP6 (HANS) 55(6 7/8) FIA8860-2018 BELL HELMET	2.100,00 €
1140003	HP6 (HANS) 56(7) FIA8860-2018 BELL HELMET	2.100,00 €
1140004	HP6 (HANS) 57(7 1/8) FIA8860-2018 BELL HELMET	2.100,00 €
1140005	HP6 (HANS) 58(7 1/4) FIA8860-2018 BELL HELMET	2.100,00 €
1140006	HP6 (HANS) 59(7 3/8) FIA8860-2018 BELL HELMET	2.100,00 €
1140007	HP6 (HANS) 60(7 1/2) FIA8860-2018 BELL HELMET	2.100,00 €
1140008	HP6 (HANS) 61(7 5/8) FIA8860-2018 BELL HELMET	2.100,00 €
1140009	HP6 (HANS) 61+(7 5/8 +) FIA8860-2018 BELL HELMET	2.100,00 €

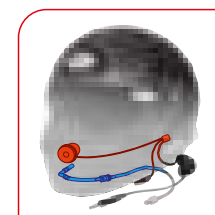

HP6 RD

1140010	HP6 RD (HANS) 54(6 3/4) FIA8860-2018 BELL HELMET	2.350,00 €
1140011	HP6 RD (HANS) 55(6 7/8) FIA8860-2018 BELL HELMET	2.350,00 €
1140012	HP6 RD (HANS) 56(7) FIA8860-2018 BELL HELMET	2.350,00 €
1140013	HP6 RD (HANS) 57(7 1/8) FIA8860-2018 BELL HELMET	2.350,00 €
1140014	HP6 RD (HANS) 58(7 1/4) FIA8860-2018 BELL HELMET	2.350,00 €
1140015	HP6 RD (HANS) 59(7 3/8) FIA8860-2018 BELL HELMET	2.350,00 €
1140016	HP6 RD (HANS) 60(7 1/2) FIA8860-2018 BELL HELMET	2.350,00 €
1140017	HP6 RD (HANS) 61(7 5/8) FIA8860-2018 BELL HELMET	2.350,00 €
1140018	HP6 RD (HANS) 61+(7 5/8 +) FIA8860-2018 BELL HELMET	2.350,00 €

RS7 CARBON



1204A21	RS7 CARBON (HANS) 54(6 3/4) FIA8859/SA2020 BELL HELMET	1.350,00 €
1204A22	RS7 CARBON (HANS) 55(6 7/8) FIA8859/SA2020 BELL HELMET	1.350,00 €
1204A23	RS7 CARBON (HANS) 56(7) FIA8859/SA2020 BELL HELMET	1.350,00 €
1204A26	RS7 CARBON (HANS) 57(7 1/8) FIA8859/SA2020 BELL HELMET	1.350,00 €
1204A27	RS7 CARBON (HANS) 58(7 1/4) FIA8859/SA2020 BELL HELMET	1.350,00 €
1204A28	RS7 CARBON (HANS) 59(7 3/8) FIA8859/SA2020 BELL HELMET	1.350,00 €
1204A30	RS7 CARBON (HANS) 60(7 1/2) FIA8859/SA2020 BELL HELMET	1.350,00 €
1204A31	RS7 CARBON (HANS) 61(7 5/8) FIA8859/SA2020 BELL HELMET	1.350,00 €
1204A32	RS7 CARBON (HANS) 61+(7 5/8 +) FIA8859/SA2020 BELL HELMET	1.350,00 €

RS7 CARBON DUCKBILL



1204A01	RS7 CARBON DUCKBILL (HANS) 54(6 3/4) FIA8859/SA2020 BELL HELMET	1.350,00 €
1204A02	RS7 CARBON DUCKBILL (HANS) 55(6 7/8) FIA8859/SA2020 BELL HELMET	1.350,00 €
1204A03	RS7 CARBON DUCKBILL (HANS) 56(7) FIA8859/SA2020 BELL HELMET	1.350,00 €
1204A06	RS7 CARBON DUCKBILL (HANS) 57(7 1/8) FIA8859/SA2020 BELL HELMET	1.350,00 €
1204A07	RS7 CARBON DUCKBILL (HANS) 58(7 1/4) FIA8859/SA2020 BELL HELMET	1.350,00 €
1204A08	RS7 CARBON DUCKBILL (HANS) 59(7 3/8) FIA8859/SA2020 BELL HELMET	1.350,00 €
1204A10	RS7 CARBON DUCKBILL (HANS) 60(7 1/2) FIA8859/SA2020 BELL HELMET	1.350,00 €
1204A11	RS7 CARBON DUCKBILL (HANS) 61(7 5/8) FIA8859/SA2020 BELL HELMET	1.350,00 €
1204A12	RS7 CARBON DUCKBILL (HANS) 61+(7 5/8 +) FIA8859/SA2020 BELL HELMET	1.350,00 €

GT6 CARBON



1239001	GT6 CARBON (HANS) 54(6 3/4) FIA8859/SA2020 BELL HELMET	1.150,00 €
1239002	GT6 CARBON (HANS) 55(6 7/8) FIA8859/SA2020 BELL HELMET	1.150,00 €
1239003	GT6 CARBON (HANS) 56(7) FIA8859/SA2020 BELL HELMET	1.150,00 €
1239004	GT6 CARBON (HANS) 57(7 1/8) FIA8859/SA2020 BELL HELMET	1.150,00 €
1239005	GT6 CARBON (HANS) 58(7 1/4) FIA8859/SA2020 BELL HELMET	1.150,00 €
1239006	GT6 CARBON (HANS) 59(7 3/8) FIA8859/SA2020 BELL HELMET	1.150,00 €
1239007	GT6 CARBON (HANS) 60(7 1/2) FIA8859/SA2020 BELL HELMET	1.150,00 €
1239008	GT6 CARBON (HANS) 61(7 5/8) FIA8859/SA2020 BELL HELMET	1.150,00 €
1239009	GT6 CARBON (HANS) 61+(7 5/8 +) FIA8859/SA2020 BELL HELMET	1.150,00 €
1239031	GT6 CARBON (HANS) 2XL(63 - 64) FIA8859/SA2020 BELL HELMET	1.150,00 €
1239032	GT6 CARBON (HANS) 3XL(65 - 66) FIA8859/SA2020 BELL HELMET	1.150,00 €
1239033	GT6 CARBON (HANS) 4XL(67 - 68) FIA8859/SA2020 BELL HELMET	1.150,00 €

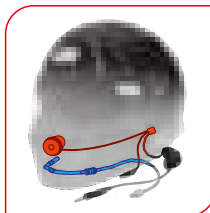

GT6 RD CARBON		
1239011	GT6 RD CARBON (HANS) 54(6 3/4) FIA8859/SA2020 BELL HELMET	1.350,00 €
1239012	GT6 RD CARBON (HANS) 55(6 7/8) FIA8859/SA2020 BELL HELMET	1.350,00 €
1239013	GT6 RD CARBON (HANS) 56(7) FIA8859/SA2020 BELL HELMET	1.350,00 €
1239014	GT6 RD CARBON (HANS) 57(7 1/8) FIA8859/SA2020 BELL HELMET	1.350,00 €
1239015	GT6 RD CARBON (HANS) 58(7 1/4) FIA8859/SA2020 BELL HELMET	1.350,00 €
1239016	GT6 RD CARBON (HANS) 59(7 3/8) FIA8859/SA2020 BELL HELMET	1.350,00 €
1239017	GT6 RD CARBON (HANS) 60(7 1/2) FIA8859/SA2020 BELL HELMET	1.350,00 €
1239018	GT6 RD CARBON (HANS) 61(7 5/8) FIA8859/SA2020 BELL HELMET	1.350,00 €
1239019	GT6 RD CARBON (HANS) 61+(7 5/8 +) FIA8859/SA2020 BELL HELMET	1.350,00 €
1239034	GT6 RD CARBON (HANS) 2XL(63 - 64) FIA8859/SA2020 BELL HELMET	1.350,00 €
1239035	GT6 RD CARBON (HANS) 3XL(65 - 66) FIA8859/SA2020 BELL HELMET	1.350,00 €
1239036	GT6 RD CARBON (HANS) 4XL(67 - 68) FIA8859/SA2020 BELL HELMET	1.350,00 €



GTX3 CARBON		
1207A02	GTX3 CARBON (HANS) 57(7 1/8) FIA8859/SA2020 BELL HELMET	1.100,00 €
1207A03	GTX3 CARBON (HANS) 58(7 1/4) FIA8859/SA2020 BELL HELMET	1.100,00 €
1207A04	GTX3 CARBON (HANS) 59(7 3/8) FIA8859/SA2020 BELL HELMET	1.100,00 €
1207A06	GTX3 CARBON (HANS) 60(7 1/2) FIA8859/SA2020 BELL HELMET	1.100,00 €
1207A07	GTX3 CARBON (HANS) 61(7 5/8) FIA8859/SA2020 BELL HELMET	1.100,00 €
1207A08	GTX3 CARBON (HANS) 61+(7 5/8 +) FIA8859/SA2020 BELL HELMET	1.100,00 €



GP3 CARBON		
1206A02	GP3 CARBON (HANS) 57(7 1/8) FIA8859/SA2020 BELL HELMET	1.050,00 €
1206A03	GP3 CARBON (HANS) 58(7 1/4) FIA8859/SA2020 BELL HELMET	1.050,00 €
1206A04	GP3 CARBON (HANS) 59(7 3/8) FIA8859/SA2020 BELL HELMET	1.050,00 €
1206A06	GP3 CARBON (HANS) 60(7 1/2) FIA8859/SA2020 BELL HELMET	1.050,00 €
1206A07	GP3 CARBON (HANS) 61(7 5/8) FIA8859/SA2020 BELL HELMET	1.050,00 €
1206A08	GP3 CARBON (HANS) 61+(7 3/8 +) FIA8859/SA2020 BELL HELMET	1.050,00 €



RS7 PRO		
1310A01	RS7 WHITE (HANS) 54(6 3/4) FIA8859/SA2020 BELL HELMET	750,00 €
1310A02	RS7 WHITE (HANS) 55(6 7/8) FIA8859/SA2020 BELL HELMET	750,00 €
1310A03	RS7 WHITE (HANS) 56(7) FIA8859/SA2020 BELL HELMET	750,00 €
1310A06	RS7 WHITE (HANS) 57(7 1/8) FIA8859/SA2020 BELL HELMET	750,00 €
1310A07	RS7 WHITE (HANS) 58(7 1/4) FIA8859/SA2020 BELL HELMET	750,00 €
1310A08	RS7 WHITE (HANS) 59(7 3/8) FIA8859/SA2020 BELL HELMET	750,00 €
1310A10	RS7 WHITE (HANS) 60(7 1/2) FIA8859/SA2020 BELL HELMET	750,00 €
1310A11	RS7 WHITE (HANS) 61(7 5/8) FIA8859/SA2020 BELL HELMET	750,00 €
1310A12	RS7 WHITE (HANS) 61+(7 5/8 +) FIA8859/SA2020 BELL HELMET	750,00 €



1310A21	RS7 MATTE BLACK (HANS) 54(6 3/4) FIA8859/SA2020 BELL HELMET	750,00 €
1310A22	RS7 MATTE BLACK (HANS) 55(6 7/8) FIA8859/SA2020 BELL HELMET	750,00 €
1310A23	RS7 MATTE BLACK (HANS) 56(7) FIA8859/SA2020 BELL HELMET	750,00 €
1310A26	RS7 MATTE BLACK (HANS) 57(7 1/8) FIA8859/SA2020 BELL HELMET	750,00 €
1310A27	RS7 MATTE BLACK (HANS) 58(7 1/4) FIA8859/SA2020 BELL HELMET	750,00 €
1310A28	RS7 MATTE BLACK (HANS) 59(7 3/8) FIA8859/SA2020 BELL HELMET	750,00 €
1310A30	RS7 MATTE BLACK (HANS) 60(7 1/2) FIA8859/SA2020 BELL HELMET	750,00 €
1310A31	RS7 MATTE BLACK (HANS) 61(7 5/8) FIA8859/SA2020 BELL HELMET	750,00 €
1310A32	RS7 MATTE BLACK (HANS) 61+(7 5/8 +) FIA8859/SA2020 BELL HELMET	750,00 €



RS7 PRO STAMINA RED		
1310A41	RS7 STAMINA RED (HANS) 54(6 3/4) FIA8859/SA2020 BELL HELMET	950,00 €
1310A42	RS7 STAMINA RED (HANS) 55(6 7/8) FIA8859/SA2020 BELL HELMET	950,00 €
1310A43	RS7 STAMINA RED (HANS) 56(7) FIA8859/SA2020 BELL HELMET	950,00 €
1310A44	RS7 STAMINA RED (HANS) 57(7 1/8) FIA8859/SA2020 BELL HELMET	950,00 €
1310A45	RS7 STAMINA RED (HANS) 58(7 1/4) FIA8859/SA2020 BELL HELMET	950,00 €
1310A46	RS7 STAMINA RED (HANS) 59(7 3/8) FIA8859/SA2020 BELL HELMET	950,00 €
1310A47	RS7 STAMINA RED (HANS) 60(7 1/2) FIA8859/SA2020 BELL HELMET	950,00 €
1310A48	RS7 STAMINA RED (HANS) 61(7 5/8) FIA8859/SA2020 BELL HELMET	950,00 €
1310A49	RS7 STAMINA RED (HANS) 61+(7 5/8 +) FIA8859/SA2020 BELL HELMET	950,00 €

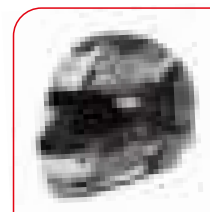

RS7 PRO STAMINA GREY		
1310A50	RS7 STAMINA GREY (HANS) 54(6 3/4) FIA8859/SA2020 BELL HELMET	950,00 €
1310A51	RS7 STAMINA GREY (HANS) 55(6 7/8) FIA8859/SA2020 BELL HELMET	950,00 €
1310A52	RS7 STAMINA GREY (HANS) 56(7) FIA8859/SA2020 BELL HELMET	950,00 €
1310A53	RS7 STAMINA GREY (HANS) 57(7 1/8) FIA8859/SA2020 BELL HELMET	950,00 €
1310A54	RS7 STAMINA GREY (HANS) 58(7 1/4) FIA8859/SA2020 BELL HELMET	950,00 €
1310A55	RS7 STAMINA GREY (HANS) 59(7 3/8) FIA8859/SA2020 BELL HELMET	950,00 €
1310A56	RS7 STAMINA GREY (HANS) 60(7 1/2) FIA8859/SA2020 BELL HELMET	950,00 €
1310A57	RS7 STAMINA GREY (HANS) 61(7 5/8) FIA8859/SA2020 BELL HELMET	950,00 €
1310A58	RS7 STAMINA GREY (HANS) 61+(7 5/8 +) FIA8859/SA2020 BELL HELMET	950,00 €



GT6 PRO WHITE		
1341001	GT6 WHITE (HANS) 54(6 3/4) FIA8859/SA2020 BELL HELMET	700,00 €
1341002	GT6 WHITE (HANS) 55(6 7/8) FIA8859/SA2020 BELL HELMET	700,00 €
1341003	GT6 WHITE (HANS) 56(7) FIA8859/SA2020 BELL HELMET	700,00 €
1341004	GT6 WHITE (HANS) 57(7 1/8) FIA8859/SA2020 BELL HELMET	700,00 €
1341005	GT6 WHITE (HANS) 58(7 1/4) FIA8859/SA2020 BELL HELMET	700,00 €
1341006	GT6 WHITE (HANS) 59(7 3/8) FIA8859/SA2020 BELL HELMET	700,00 €
1341007	GT6 WHITE (HANS) 60(7 1/2) FIA8859/SA2020 BELL HELMET	700,00 €
1341008	GT6 WHITE (HANS) 61(7 5/8) FIA8859/SA2020 BELL HELMET	700,00 €
1341009	GT6 WHITE (HANS) 61+(7 5/8 +) FIA8859/SA2020 BELL HELMET	700,00 €
1341081	GT6 WHITE (HANS) 2XL(63 - 64) FIA8859/SA2020 BELL HELMET	700,00 €
1341082	GT6 WHITE (HANS) 3XL(65 - 66) FIA8859/SA2020 BELL HELMET	700,00 €
1341083	GT6 WHITE (HANS) 4XL(67 - 68) FIA8859/SA2020 BELL HELMET	700,00 €



GT6 PRO MATTE BLACK		
1341011	GT6 MATTE BLACK (HANS) 54(6 3/4) FIA8859/SA2020 BELL HELMET	700,00 €
1341012	GT6 MATTE BLACK (HANS) 55(6 7/8) FIA8859/SA2020 BELL HELMET	700,00 €
1341013	GT6 MATTE BLACK (HANS) 56(7) FIA8859/SA2020 BELL HELMET	700,00 €
1341014	GT6 MATTE BLACK (HANS) 57(7 1/8) FIA8859/SA2020 BELL HELMET	700,00 €
1341015	GT6 MATTE BLACK (HANS) 58(7 1/4) FIA8859/SA2020 BELL HELMET	700,00 €
1341016	GT6 MATTE BLACK (HANS) 59(7 3/8) FIA8859/SA2020 BELL HELMET	700,00 €
1341017	GT6 MATTE BLACK (HANS) 60(7 1/2) FIA8859/SA2020 BELL HELMET	700,00 €
1341018	GT6 MATTE BLACK (HANS) 61(7 5/8) FIA8859/SA2020 BELL HELMET	700,00 €
1341019	GT6 MATTE BLACK (HANS) 61+(7 5/8 +) FIA8859/SA2020 BELL HELMET	700,00 €
1341084	GT6 MATTE BLACK (HANS) 2XL(63 - 64) FIA8859/SA2020 BELL HELMET	700,00 €
1341085	GT6 MATTE BLACK (HANS) 3XL(65 - 66) FIA8859/SA2020 BELL HELMET	700,00 €
1341086	GT6 MATTE BLACK (HANS) 4XL(67 - 68) FIA8859/SA2020 BELL HELMET	700,00 €

GT6 PRO LEMANS

	1341111	GT6 LEMANS EDITION (HANS) 56(7) FIA8859/SA2020 BELL HELMET	800,00 €
	1341112	GT6 LEMANS EDITION (HANS) 57(7 1/8) FIA8859/SA2020 BELL HELMET	800,00 €
	1341113	GT6 LEMANS EDITION (HANS) 58(7 1/4) FIA8859/SA2020 BELL HELMET	800,00 €
	1341114	GT6 LEMANS EDITION (HANS) 59(7 3/8) FIA8859/SA2020 BELL HELMET	800,00 €
	1341115	GT6 LEMANS EDITION (HANS) 60(7 1/2) FIA8859/SA2020 BELL HELMET	800,00 €
	1341116	GT6 LEMANS EDITION (HANS) 61(7 5/8) FIA8859/SA2020 BELL HELMET	800,00 €
	1341117	GT6 LEMANS EDITION (HANS) 61+(7 5/8 +) FIA8859/SA2020 BELL HELMET	800,00 €

GT5 SPORT

	1442A11	GT5 SPORT WHITE SML(57-58) FIA8859-2015 BELL HELMET	450,00 €
	1442A12	GT5 SPORT WHITE MED(58-59) FIA8859-2015 BELL HELMET	450,00 €
	1442A13	GT5 SPORT WHITE LRG(60-61) FIA8859-2015 BELL HELMET	450,00 €
	1442A14	GT5 SPORT WHITE XLG(61-61 +) FIA8859-2015 BELL HELMET	450,00 €
	1442A01	GT5 SPORT WHITE (HANS) SML(57-58) FIA8859-2015 BELL HELMET	500,00 €
	1442A02	GT5 SPORT WHITE (HANS) MED(58-59) FIA8859-2015 BELL HELMET	500,00 €
	1442A03	GT5 SPORT WHITE (HANS) LRG(60-61) FIA8859-2015 BELL HELMET	500,00 €
	1442A04	GT5 SPORT WHITE (HANS) XLG(61-61 +) FIA8859-2015 BELL HELMET	500,00 €

GT5 SPORT OFFSHORE

	1442A21	GT5 SPORT ORANGE SML(57-58) FIA8859-2015 BELL HELMET	450,00 €
	1442A22	GT5 SPORT ORANGE MED(58-59) FIA8859-2015 BELL HELMET	450,00 €
	1442A23	GT5 SPORT ORANGE LRG(60-61) FIA8859-2015 BELL HELMET	450,00 €
	1442A24	GT5 SPORT ORANGE XLG(61-61 +) FIA8859-2015 BELL HELMET	450,00 €

GP3 SPORT WHITE

	1417001	GP3 SPORT WHITE SML(57-58) FIA8859-2015 BELL HELMET	600,00 €
	1417002	GP3 SPORT WHITE MED(58-59) FIA8859-2015 BELL HELMET	600,00 €
	1417003	GP3 SPORT WHITE LRG(60-61) FIA8859-2015 BELL HELMET	600,00 €
	1417004	GP3 SPORT WHITE XLG(61-61 +) FIA8859-2015 BELL HELMET	600,00 €
	1417021	GP3 SPORT WHITE (HANS) SML(57-58) FIA8859-2015 BELL HELMET	650,00 €
	1417022	GP3 SPORT WHITE (HANS) MED(58-59) FIA8859-2015 BELL HELMET	650,00 €
	1417023	GP3 SPORT WHITE (HANS) LRG(60-61) FIA8859-2015 BELL HELMET	650,00 €
	1417024	GP3 SPORT WHITE (HANS) XLG(61-61 +) FIA8859-2015 BELL HELMET	650,00 €

GP3 SPORT MATTE BLACK

	1417011	GP3 SPORT MATTE BLACK SML(57-58) FIA8859-2015 BELL HELMET	600,00 €
	1417012	GP3 SPORT MATTE BLACK MED(58-59) FIA8859-2015 BELL HELMET	600,00 €
	1417013	GP3 SPORT MATTE BLACK LRG(60-61) FIA8859-2015 BELL HELMET	600,00 €
	1417014	GP3 SPORT MATTE BLACK XLG(61-61 +) FIA8859-2015 BELL HELMET	600,00 €
	1417031	GP3 SPORT MATTE BLACK (HANS) SML(57-58) FIA8859-2015 BELL HELMET	650,00 €
	1417032	GP3 SPORT MATTE BLACK (HANS) MED(58-59) FIA8859-2015 BELL HELMET	650,00 €
	1417033	GP3 SPORT MATTE BLACK (HANS) LRG(60-61) FIA8859-2015 BELL HELMET	650,00 €
	1417034	GP3 SPORT MATTE BLACK (HANS) XLG(61-61 +) FIA8859-2015 BELL HELMET	650,00 €

X-1

	1453001	X-1 WHITE (HANS) SML(57-58) FIA8859-2015 BELL HELMET	450,00 €
	1453002	X-1 WHITE (HANS) MED(58-59) FIA8859-2015 BELL HELMET	450,00 €
	1453003	X-1 WHITE (HANS) LRG(60-61) FIA8859-2015 BELL HELMET	450,00 €
	1453004	X-1 WHITE (HANS) XLG(61-61 +) FIA8859-2015 BELL HELMET	450,00 €

RALLY

HP10 RALLY WW

	1144051	HP10 RALLY WW (HANS) 54(7 1/8) FIA8860-2018 BELL HELMET	2.700,00 €
	1144052	HP10 RALLY WW (HANS) 55(7 1/4) FIA8860-2018 BELL HELMET	2.700,00 €
	1144053	HP10 RALLY WW (HANS) 56(7 3/8) FIA8860-2018 BELL HELMET	2.700,00 €
	1144056	HP10 RALLY WW (HANS) 57(7 1/8) FIA8860-2018 BELL HELMET	2.700,00 €
	1144057	HP10 RALLY WW (HANS) 58(7 1/4) FIA8860-2018 BELL HELMET	2.700,00 €
	1144058	HP10 RALLY WW (HANS) 59(7 3/8) FIA8860-2018 BELL HELMET	2.700,00 €
	1144060	HP10 RALLY WW (HANS) 60(7 1/2) FIA8860-2018 BELL HELMET	2.700,00 €
	1144061	HP10 RALLY WW (HANS) 61(7 5/8) FIA8860-2018 BELL HELMET	2.700,00 €
	1144062	HP10 RALLY WW (HANS) 61+(7 5/8 +) FIA8860-2018 BELL HELMET	2.700,00 €

HP6 RALLY

	1140131	HP6 RALLY (HANS) 54(6 3/4) FIA8860-2018 BELL HELMET	2.300,00 €
	1140132	HP6 RALLY (HANS) 55(6 7/8) FIA8860-2018 BELL HELMET	2.300,00 €
	1140133	HP6 RALLY (HANS) 56(7) FIA8860-2018 BELL HELMET	2.300,00 €
	1140134	HP6 RALLY (HANS) 57(7 1/8) FIA8860-2018 BELL HELMET	2.300,00 €
	1140135	HP6 RALLY (HANS) 58(7 1/4) FIA8860-2018 BELL HELMET	2.300,00 €
	1140136	HP6 RALLY (HANS) 59(7 3/8) FIA8860-2018 BELL HELMET	2.300,00 €
	1140137	HP6 RALLY (HANS) 60(7 1/2) FIA8860-2018 BELL HELMET	2.300,00 €
	1140138	HP6 RALLY (HANS) 61(7 5/8) FIA8860-2018 BELL HELMET	2.300,00 €
	1140139	HP6 RALLY (HANS) 61+(7 5/8 +) FIA8860-2018 BELL HELMET	2.300,00 €

MAG10 RALLY CARBON

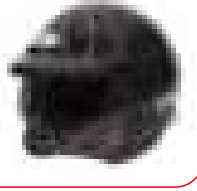
	1245011	MAG-10 RALLY CARBON (HANS) 54(6 3/4) FIA8859/SA2020 BELL HELMET	1.200,00 €
	1245012	MAG-10 RALLY CARBON (HANS) 55(6 7/8) FIA8859/SA2020 BELL HELMET	1.200,00 €
	1245013	MAG-10 RALLY CARBON (HANS) 56(7) FIA8859/SA2020 BELL HELMET	1.200,00 €
	1245014	MAG-10 RALLY CARBON (HANS) 57(7 1/8) FIA8859/SA2020 BELL HELMET	1.200,00 €
	1245015	MAG-10 RALLY CARBON (HANS) 58(7 1/4) FIA8859/SA2020 BELL HELMET	1.200,00 €
	1245016	MAG-10 RALLY CARBON (HANS) 59(7 3/8) FIA8859/SA2020 BELL HELMET	1.200,00 €
	1245017	MAG-10 RALLY CARBON (HANS) 60(7 1/2) FIA8859/SA2020 BELL HELMET	1.200,00 €
	1245018	MAG-10 RALLY CARBON (HANS) 61(7 5/8) FIA8859/SA2020 BELL HELMET	1.200,00 €
	1245019	MAG-10 RALLY CARBON (HANS) 61+(7 5/8 +) FIA8859/SA2020 BELL HELMET	1.200,00 €

MAG10 RALLY WW CARBON

	1245101	MAG-10 RALLY WW CARBON (HANS) 54(6 3/4) FIA8859/SA2020 BELL HELMET	1.400,00 €
	1245102	MAG-10 RALLY WW CARBON (HANS) 55(6 7/8) FIA8859/SA2020 BELL HELMET	1.400,00 €
	1245103	MAG-10 RALLY WW CARBON (HANS) 56(7) FIA8859/SA2020 BELL HELMET	1.400,00 €
	1245106	MAG-10 RALLY WW CARBON (HANS) 57(7 1/8) FIA8859/SA2020 BELL HELMET	1.400,00 €
	1245107	MAG-10 RALLY WW CARBON (HANS) 58(7 1/4) FIA8859/SA2020 BELL HELMET	1.400,00 €
	1245108	MAG-10 RALLY WW CARBON (HANS) 59(7 3/8) FIA8859/SA2020 BELL HELMET	1.400,00 €
	1245110	MAG-10 RALLY WW CARBON (HANS) 60(7 1/2) FIA8859/SA2020 BELL HELMET	1.400,00 €
	1245111	MAG-10 RALLY WW CARBON (HANS) 61(7 5/8) FIA8859/SA2020 BELL HELMET	1.400,00 €
	1245112	MAG-10 RALLY WW CARBON (HANS) 61+(7 5/8 +) FIA8859/SA2020 BELL HELMET	1.400,00 €



GT6 RALLY CARBON		
1239131	GT6 RALLY CARBON (HANS) 54(6 3/4) FIA8859/SA2020 BELL HELMET	1.300,00 €
1239132	GT6 RALLY CARBON (HANS) 55(6 7/8) FIA8859/SA2020 BELL HELMET	1.300,00 €
1239133	GT6 RALLY CARBON (HANS) 56(7) FIA8859/SA2020 BELL HELMET	1.300,00 €
1239134	GT6 RALLY CARBON (HANS) 57(7 1/8) FIA8859/SA2020 BELL HELMET	1.300,00 €
1239135	GT6 RALLY CARBON (HANS) 58(7 1/4) FIA8859/SA2020 BELL HELMET	1.300,00 €
1239136	GT6 RALLY CARBON (HANS) 59(7 3/8) FIA8859/SA2020 BELL HELMET	1.300,00 €
1239137	GT6 RALLY CARBON (HANS) 60(7 1/2) FIA8859/SA2020 BELL HELMET	1.300,00 €
1239138	GT6 RALLY CARBON (HANS) 61(7 5/8) FIA8859/SA2020 BELL HELMET	1.300,00 €
1239139	GT6 RALLY CARBON (HANS) 61+(7 5/8 +) FIA8859/SA2020 BELL HELMET	1.300,00 €
1239037	GT6 RALLY CARBON (HANS) 2XL(63 - 64) FIA8859/SA2020 BELL HELMET	1.300,00 €
1239038	GT6 RALLY CARBON (HANS) 3XL(65 - 66) FIA8859/SA2020 BELL HELMET	1.300,00 €
1239039	GT6 RALLY CARBON (HANS) 4XL(67 - 68) FIA8859/SA2020 BELL HELMET	1.300,00 €



MAG-10 RALLY PRO		
1346011	MAG-10 RALLY PRO WHITE (HANS) 54(6 3/4) FIA8859/SA2020 BELL HELMET	800,00 €
1346012	MAG-10 RALLY PRO WHITE (HANS) 55(6 7/8) FIA8859/SA2020 BELL HELMET	800,00 €
1346013	MAG-10 RALLY PRO WHITE (HANS) 56(7) FIA8859/SA2020 BELL HELMET	800,00 €
1346014	MAG-10 RALLY PRO WHITE (HANS) 57(7 1/8) FIA8859/SA2020 BELL HELMET	800,00 €
1346015	MAG-10 RALLY PRO WHITE (HANS) 58(7 1/4) FIA8859/SA2020 BELL HELMET	800,00 €
1346016	MAG-10 RALLY PRO WHITE (HANS) 59(7 3/8) FIA8859/SA2020 BELL HELMET	800,00 €
1346017	MAG-10 RALLY PRO WHITE (HANS) 60(7 1/2) FIA8859/SA2020 BELL HELMET	800,00 €
1346018	MAG-10 RALLY PRO WHITE (HANS) 61(7 5/8) FIA8859/SA2020 BELL HELMET	800,00 €
1346019	MAG-10 RALLY PRO WHITE (HANS) 61+(7 5/8 +) FIA8859/SA2020 BELL HELMET	800,00 €

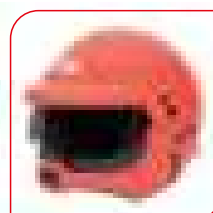

MAG-10 RALLY PRO OFFSHORE		
1346021	MAG-10 RALLY PRO ORANGE (HANS) 54(6 3/4) FIA8859/SA2020 BELL HELMET	800,00 €
1346022	MAG-10 RALLY PRO ORANGE (HANS) 55(6 7/8) FIA8859/SA2020 BELL HELMET	800,00 €
1346023	MAG-10 RALLY PRO ORANGE (HANS) 56(7) FIA8859/SA2020 BELL HELMET	800,00 €
1346024	MAG-10 RALLY PRO ORANGE (HANS) 57(7 1/8) FIA8859/SA2020 BELL HELMET	800,00 €
1346025	MAG-10 RALLY PRO ORANGE (HANS) 58(7 1/4) FIA8859/SA2020 BELL HELMET	800,00 €
1346026	MAG-10 RALLY PRO ORANGE (HANS) 59(7 3/8) FIA8859/SA2020 BELL HELMET	800,00 €
1346027	MAG-10 RALLY PRO ORANGE (HANS) 60(7 1/2) FIA8859/SA2020 BELL HELMET	800,00 €
1346028	MAG-10 RALLY PRO ORANGE (HANS) 61(7 5/8) FIA8859/SA2020 BELL HELMET	800,00 €
1346029	MAG-10 RALLY PRO ORANGE (HANS) 61+(7 5/8 +) FIA8859/SA2020 BELL HELMET	800,00 €

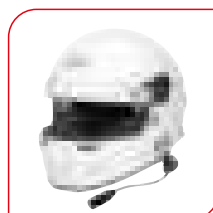

GT6 RALLY PRO		
1341061	GT6 RALLY WHITE (HANS) 54(6 3/4) FIA8859/SA2020 BELL HELMET	900,00 €
1341062	GT6 RALLY WHITE (HANS) 55(6 7/8) FIA8859/SA2020 BELL HELMET	900,00 €
1341063	GT6 RALLY WHITE (HANS) 56(7) FIA8859/SA2020 BELL HELMET	900,00 €
1341064	GT6 RALLY WHITE (HANS) 57(7 1/8) FIA8859/SA2020 BELL HELMET	900,00 €
1341065	GT6 RALLY WHITE (HANS) 58(7 1/4) FIA8859/SA2020 BELL HELMET	900,00 €
1341066	GT6 RALLY WHITE (HANS) 59(7 3/8) FIA8859/SA2020 BELL HELMET	900,00 €
1341067	GT6 RALLY WHITE (HANS) 60(7 1/2) FIA8859/SA2020 BELL HELMET	900,00 €
1341068	GT6 RALLY WHITE (HANS) 61(7 5/8) FIA8859/SA2020 BELL HELMET	900,00 €
1341069	GT6 RALLY WHITE (HANS) 61+(7 5/8 +) FIA8859/SA2020 BELL HELMET	900,00 €
1341088	GT6 RALLY WHITE (HANS) 2XL(63 - 64) FIA8859/SA2020 BELL HELMET	900,00 €
1341089	GT6 RALLY WHITE (HANS) 3XL(65 - 66) FIA8859/SA2020 BELL HELMET	900,00 €
1341090	GT6 RALLY WHITE (HANS) 4XL(67 - 68) FIA8859/SA2020 BELL HELMET	900,00 €

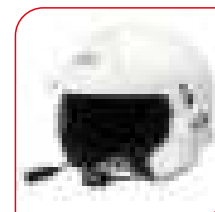

MAG-10 RALLY SPORT		
1443A01	MAG-10 RALLY SPORT WHITE (HANS) XXS(54-55) FIA8859-2015 BELL HELMET	600,00 €
1443A02	MAG-10 RALLY SPORT WHITE (HANS) XSM(55-56) FIA8859-2015 BELL HELMET	600,00 €
1443A03	MAG-10 RALLY SPORT WHITE (HANS) SML(57-58) FIA8859-2015 BELL HELMET	600,00 €
1443A04	MAG-10 RALLY SPORT WHITE (HANS) MED(58-59) FIA8859-2015 BELL HELMET	600,00 €
1443A05	MAG-10 RALLY SPORT WHITE (HANS) LRG(60-61) FIA8859-2015 BELL HELMET	600,00 €
1443A06	MAG-10 RALLY SPORT WHITE (HANS) XLG(61-61 +) FIA8859-2015 BELL HELMET	600,00 €



MAG RALLY		
1435A01	MAG RALLY TITANIUM S. (HANS) SML(57-58) FIA8859-2015 BELL HELMET	390,00 €
1435A02	MAG RALLY TITANIUM S. (HANS) MED(58-59) FIA8859-2015 BELL HELMET	390,00 €
1435A03	MAG RALLY TITANIUM S. (HANS) LRG(60-61) FIA8859-2015 BELL HELMET	390,00 €
1435A04	MAG RALLY TITANIUM S. (HANS) XLG(61-61 +) FIA8859-2015 BELL HELMET	390,00 €

CIRCUIT OPEN FACE HELMETS

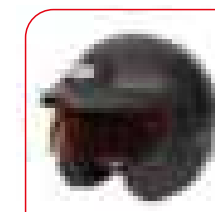

HP10		
1144001	HP10 (HANS) 54(6 3/4) FIA8860-2018 BELL HELMET	2.100,00 €
1144002	HP10 (HANS) 55(6 7/8) FIA8860-2018 BELL HELMET	2.100,00 €
1144003	HP10 (HANS) 56(7) FIA8860-2018 BELL HELMET	2.100,00 €
1144004	HP10 (HANS) 57(7 1/8) FIA8860-2018 BELL HELMET	2.100,00 €
1144005	HP10 (HANS) 58(7 1/4) FIA8860-2018 BELL HELMET	2.100,00 €
1144006	HP10 (HANS) 59(7 3/8) FIA8860-2018 BELL HELMET	2.100,00 €
1144007	HP10 (HANS) 60(7 1/2) FIA8860-2018 BELL HELMET	2.100,00 €
1144008	HP10 (HANS) 61(7 5/8) FIA8860-2018 BELL HELMET	2.100,00 €
1144009	HP10 (HANS) 61+(7 5/8 +) FIA8860-2018 BELL HELMET	2.100,00 €



MAG-10 CARBON		
1245001	MAG-10 CARBON (HANS) 54(6 3/4) FIA8859/SA2020 BELL HELMET	1.100,00 €
1245002	MAG-10 CARBON (HANS) 55(6 7/8) FIA8859/SA2020 BELL HELMET	1.100,00 €
1245003	MAG-10 CARBON (HANS) 56(7) FIA8859/SA2020 BELL HELMET	1.100,00 €
1245004	MAG-10 CARBON (HANS) 57(7 1/8) FIA8859/SA2020 BELL HELMET	1.100,00 €
1245005	MAG-10 CARBON (HANS) 58(7 1/4) FIA8859/SA2020 BELL HELMET	1.100,00 €
1245006	MAG-10 CARBON (HANS) 59(7 3/8) FIA8859/SA2020 BELL HELMET	1.100,00 €
1245007	MAG-10 CARBON (HANS) 60(7 1/2) FIA8859/SA2020 BELL HELMET	1.100,00 €
1245008	MAG-10 CARBON (HANS) 61(7 5/8) FIA8859/SA2020 BELL HELMET	1.100,00 €
1245009	MAG-10 CARBON (HANS) 61+(7 5/8 +) FIA8859/SA2020 BELL HELMET	1.100,00 €

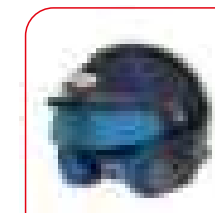

MAG-10 CARBON SENNA		
1245081	MAG-10 CARBON AYRTON SENNA (HANS) 54(6 3/4) FIA8859/SA2020 BELL HELMET	1.300,00 €
1245082	MAG-10 CARBON AYRTON SENNA (HANS) 55(6 7/8) FIA8859/SA2020 BELL HELMET	1.300,00 €
1245083	MAG-10 CARBON AYRTON SENNA (HANS) 56(7) FIA8859/SA2020 BELL HELMET	1.300,00 €
1245086	MAG-10 CARBON AYRTON SENNA (HANS) 57(7 1/8) FIA8859/SA2020 BELL HELMET	1.300,00 €
1245087	MAG-10 CARBON AYRTON SENNA (HANS) 58(7 1/4) FIA8859/SA2020 BELL HELMET	1.300,00 €
1245088	MAG-10 CARBON AYRTON SENNA (HANS) 59(7 3/8) FIA8859/SA2020 BELL HELMET	1.300,00 €
1245090	MAG-10 CARBON AYRTON SENNA (HANS) 60(7 1/2) FIA8859/SA2020 BELL HELMET	1.300,00 €
1245091	MAG-10 CARBON AYRTON SENNA (HANS) 61(7 5/8) FIA8859/SA2020 BELL HELMET	1.300,00 €
1245092	MAG-10 CARBON AYRTON SENNA (HANS) 61+(7 5/8 +) FIA8859/SA2020 BELL HELMET	1.300,00 €



MAG-10 PRO		
1346001	MAG-10 WHITE (HANS) 54(6 3/4) FIA8859/SA2020 BELL HELMET	550,00 €
1346002	MAG-10 WHITE (HANS) 55(6 7/8) FIA8859/SA2020 BELL HELMET	550,00 €
1346003	MAG-10 WHITE (HANS) 56(7) FIA8859/SA2020 BELL HELMET	550,00 €
1346004	MAG-10 WHITE (HANS) 57(7 1/8) FIA8859/SA2020 BELL HELMET	550,00 €
1346005	MAG-10 WHITE (HANS) 58(7 1/4) FIA8859/SA2020 BELL HELMET	550,00 €
1346006	MAG-10 WHITE (HANS) 59(7 3/8) FIA8859/SA2020 BELL HELMET	550,00 €
1346007	MAG-10 WHITE (HANS) 60(7 1/2) FIA8859/SA2020 BELL HELMET	550,00 €
1346008	MAG-10 WHITE (HANS) 61(7 5/8) FIA8859/SA2020 BELL HELMET	550,00 €
1346009	MAG-10 WHITE (HANS) 61+(7 5/8 +) FIA8859/SA2020 BELL HELMET	550,00 €



MAG		
1435A11	MAG TITANIUM S. SML(57-58) FIA8859-SA2015 BELL HELMET	300,00 €
1435A12	MAG TITANIUM S. MED(58-59) FIA8859-SA2015 BELL HELMET	300,00 €
1435A13	MAG TITANIUM S. LRG(60-61) FIA8859-SA2015 BELL HELMET	300,00 €
1435A14	MAG TITANIUM S. XLG(61-61+) FIA8859-SA2015 BELL HELMET	300,00 €
1435A31	MAG TITANIUM S. (HANS) SML(57-58) FIA8859 BELL HELMET	350,00 €
1435A32	MAG TITANIUM S. (HANS) MED(58-59) FIA8859 BELL HELMET	350,00 €
1435A33	MAG TITANIUM S. (HANS) LRG(60-61) FIA8859 BELL HELMET	350,00 €
1435A34	MAG TITANIUM S. (HANS) XLG(61-61+) FIA8859 BELL HELMET	350,00 €

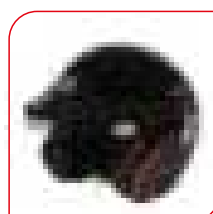

LEMANS MAG		
1435A41	MAG LEMANS EDITION SML(57-58) FIA8859-2015 BELL HELMET	450,00 €
1435A42	MAG LEMANS EDITION MED(58-59) FIA8859-2015 BELL HELMET	450,00 €
1435A43	MAG LEMANS EDITION LRG(60-61) FIA8859-2015 BELL HELMET	450,00 €
1435A44	MAG LEMANS EDITION XLG(61-61+) FIA8859-2015 BELL HELMET	450,00 €

KARTING

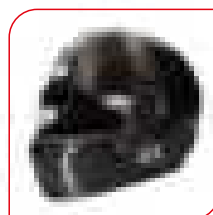

RS7-K CARBON		
1204A42	RS7-K CARBON 57(7 1/8) K2020 BELL HELMET	1.100,00 €
1204A43	RS7-K CARBON 58(7 1/4) K2020 BELL HELMET	1.100,00 €
1204A44	RS7-K CARBON 59(7 3/8) K2020 BELL HELMET	1.100,00 €
1204A45	RS7-K CARBON 59+(7 3/8 +) K2020 BELL HELMET	1.100,00 €
1204A46	RS7-K CARBON 60(7 1/2) K2020 BELL HELMET	1.100,00 €
1204A47	RS7-K CARBON 61(7 5/8) K2020 BELL HELMET	1.100,00 €
1204A48	RS7-K CARBON 61+(7 5/8 +) K2020 BELL HELMET	1.100,00 €
1204A49	RS7-K CARBON 54(6 3/4) K2020 BELL HELMET	1.100,00 €
1204A50	RS7-K CARBON 55(6 7/8) K2020 BELL HELMET	1.100,00 €
1204A51	RS7-K CARBON 56(7) K2020 BELL HELMET	1.100,00 €



KC7-CMR CARBON		
1205001	KC7-CMR CARBON 54(6 3/4) CMR2016 BELL HELMET	1.050,00 €
1205002	KC7-CMR CARBON 55(6 7/8) CMR2016 BELL HELMET	1.050,00 €
1205003	KC7-CMR CARBON 56(7) CMR2016 BELL HELMET	1.050,00 €
1205004	KC7-CMR CARBON 57(7 1/8) CMR2016 BELL HELMET	1.050,00 €
1205005	KC7-CMR CARBON 58(7 1/4) CMR2016 BELL HELMET	1.050,00 €
1205006	KC7-CMR CARBON 59(7 3/8) CMR2016 BELL HELMET	1.050,00 €

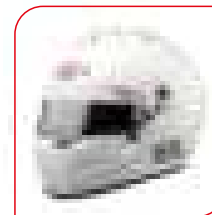

RS7-K		
1310A61	RS7-K WHITE SML (57 -58) K2020 BELL HELMET	600,00 €
1310A62	RS7-K WHITE MED (58-59) K2020 BELL HELMET	600,00 €
1310A63	RS7-K WHITE LRG (60-61) K2020 BELL HELMET	600,00 €
1310A64	RS7-K WHITE XLG(61-61+) K2020 BELL HELMET	600,00 €



RS7-K STAMINA WHITE/BLUE		
1310A81	RS7-K STAMINA WHITE/BLUE SML (57 -58) K2020 BELL HELMET	750,00 €
1310A82	RS7-K STAMINA WHITE/BLUE MED (58-59) K2020 BELL HELMET	750,00 €
1310A83	RS7-K STAMINA WHITE/BLUE LRG (60-61) K2020 BELL HELMET	750,00 €
1310A84	RS7-K STAMINA WHITE/BLUE XLG(61-61+) K2020 BELL HELMET	750,00 €



RS7-K STAMINA YELLOW		
1310A91	RS7-K STAMINA YELLOW SML (57 -58) K2020 BELL HELMET	750,00 €
1310A92	RS7-K STAMINA YELLOW MED (58-59) K2020 BELL HELMET	750,00 €
1310A93	RS7-K STAMINA YELLOW LRG (60-61) K2020 BELL HELMET	750,00 €
1310A94	RS7-K STAMINA YELLOW XLG (61-61+) K2020 BELL HELMET	750,00 €



KC7-EV CMS		
1354001	KC7-EV CMS WHITE 51(6 1/4) CMR2016 BELL HELMET	460,00 €
1354002	KC7-EV CMS WHITE 52(6 1/2) CMR2016 BELL HELMET	460,00 €
1354003	KC7-EC CMS WHITE 53(6 5/8) CMR2016 BELL HELMET	460,00 €
1354004	KC7-EV CMS WHITE 54(6 3/4) CMR2016 BELL HELMET	460,00 €
1354005	KC7-EV CMS WHITE 55(6 7/8) CMR2016 BELL HELMET	460,00 €
1354006	KC7-EV CMS WHITE 56(7) CMR2016 BELL HELMET	460,00 €
1354007	KC7-EV CMS WHITE 57 (7 1/8) CMR2016 BELL HELMET	460,00 €
1354008	KC7-EV CMS WHITE 58(7 1/4) CMR2016 BELL HELMET	460,00 €
1354009	KC7-EV CMS WHITE 59(7 3/8) CMR2016 BELL HELMET	460,00 €



KC7-CMR		
1311003	KC7-CMR WHITE 54(6 3/4) CMR2016 BELL HELMET	490,00 €
1311004	KC7-CMR WHITE 55(6 7/8) CMR2016 BELL HELMET	490,00 €
1311005	KC7-CMR WHITE 56(7) CMR2016 BELL HELMET	490,00 €
1311006	KC7-CMR WHITE 57 (7 1/8) CMR2016 BELL HELMET	490,00 €
1311007	KC7-CMR WHITE 58(7 1/4) CMR2016 BELL HELMET	490,00 €
1311008	KC7-CMR WHITE 59(7 3/8) CMR2016 BELL HELMET	490,00 €



KC7-CMR CHAMPION BLUE		
1311101	KC7-CMR CHAMPION BLUE 54(6 3/4) CMR2016 BELL HELMET	700,00 €
1311102	KC7-CMR CHAMPION BLUE 55(6 7/8) CMR2016 BELL HELMET	700,00 €
1311103	KC7-CMR CHAMPION BLUE 56(7) CMR2016 BELL HELMET	700,00 €
1311104	KC7-CMR CHAMPION BLUE 57(7 1/8) CMR2016 BELL HELMET	700,00 €
1311105	KC7-CMR CHAMPION BLUE 58(7 1/4) CMR2016 BELL HELMET	700,00 €
1311106	KC7-CMR CHAMPION BLUE 59(7 3/8) CMR2016 BELL HELMET	700,00 €

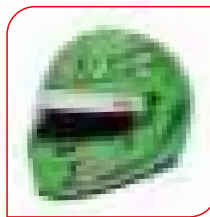

KC7-CMR CHAMPION GREEN		
1311111	KC7-CMR CHAMPION GREEN 54(6 3/4) CMR2016 BELL HELMET	700,00 €
1311112	KC7-CMR CHAMPION GREEN 55(6 7/8) CMR2016 BELL HELMET	700,00 €
1311113	KC7-CMR CHAMPION GREEN 56(7) CMR2016 BELL HELMET	700,00 €
1311114	KC7-CMR CHAMPION GREEN 57(7 1/8) CMR2016 BELL HELMET	700,00 €
1311115	KC7-CMR CHAMPION GREEN 58(7 1/4) CMR2016 BELL HELMET	700,00 €
1311116	KC7-CMR CHAMPION GREEN 59(7 3/8) CMR2016 BELL HELMET	700,00 €



KC7-CMR CHAMPION ORANGE		
1311121	KC7-CMR CHAMPION ORANGE 54(6 3/4) CMR2016 BELL HELMET	700,00 €
1311122	KC7-CMR CHAMPION ORANGE 55(6 7/8) CMR2016 BELL HELMET	700,00 €
1311123	KC7-CMR CHAMPION ORANGE 56(7) CMR2016 BELL HELMET	700,00 €
1311124	KC7-CMR CHAMPION ORANGE 57(7 1/8) CMR2016 BELL HELMET	700,00 €
1311125	KC7-CMR CHAMPION ORANGE 58(7 1/4) CMR2016 BELL HELMET	700,00 €
1311126	KC7-CMR CHAMPION ORANGE 59(7 3/8) CMR2016 BELL HELMET	700,00 €

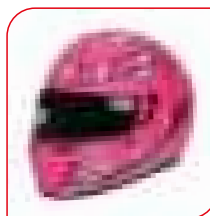

KC7-CMR CHAMPION PINK		
1311131	KC7-CMR CHAMPION PINK 54(6 3/4) CMR2016 BELL HELMET	700,00 €
1311132	KC7-CMR CHAMPION PINK 55(6 7/8) CMR2016 BELL HELMET	700,00 €
1311133	KC7-CMR CHAMPION PINK 56(7) CMR2016 BELL HELMET	700,00 €
1311134	KC7-CMR CHAMPION PINK 57(7 1/8) CMR2016 BELL HELMET	700,00 €
1311135	KC7-CMR CHAMPION PINK 58(7 1/4) CMR2016 BELL HELMET	700,00 €
1311136	KC7-CMR CHAMPION PINK 59(7 3/8) CMR2016 BELL HELMET	700,00 €



KC7-CMR AYRTON SENNA KARTING		
1311161	KC7-CMR AYRTON SENNA KARTING 54(6 3/4) CMR2016 BELL HELMET	850,00 €
1311162	KC7-CMR AYRTON SENNA KARTING 55(6 7/8) CMR2016 BELL HELMET	850,00 €
1311163	KC7-CMR AYRTON SENNA KARTING 56(7) CMR2016 BELL HELMET	850,00 €
1311164	KC7-CMR AYRTON SENNA KARTING 57(7 1/8) CMR2016 BELL HELMET	850,00 €
1311165	KC7-CMR AYRTON SENNA KARTING 58(7 1/4) CMR2016 BELL HELMET	850,00 €
1311166	KC7-CMR AYRTON SENNA KARTING 59(7 3/8) CMR2016 BELL HELMET	850,00 €



KC7-CMR LEWIS HAMILTON KARTING		
1311081	KC7-CMR LEWIS HAMILTON KARTING 54(6 3/4) CMR2016 BELL HELMET	850,00 €
1311082	KC7-CMR LEWIS HAMILTON KARTING 55(6 7/8) CMR2016 BELL HELMET	850,00 €
1311083	KC7-CMR LEWIS HAMILTON KARTING 56(7) CMR2016 BELL HELMET	850,00 €
1311084	KC7-CMR LEWIS HAMILTON KARTING 57(7 1/8) CMR2016 BELL HELMET	850,00 €
1311085	KC7-CMR LEWIS HAMILTON KARTING 58(7 1/4) CMR2016 BELL HELMET	850,00 €
1311086	KC7-CMR LEWIS HAMILTON KARTING 59(7 3/8) CMR2016 BELL HELMET	850,00 €

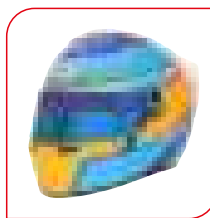

KC7-CMR FERNANDO ALONSO KARTING		
1311091	KC7-CMR FERNANDO ALONSO KARTING 54(6 3/4) CMR2016 BELL HELMET	850,00 €
1311092	KC7-CMR FERNANDO ALONSO KARTING 55(6 7/8) CMR2016 BELL HELMET	850,00 €
1311093	KC7-CMR FERNANDO ALONSO KARTING 56(7) CMR2016 BELL HELMET	850,00 €
1311094	KC7-CMR FERNANDO ALONSO KARTING 57(7 1/8) CMR2016 BELL HELMET	850,00 €
1311095	KC7-CMR FERNANDO ALONSO KARTING 58(7 1/4) CMR2016 BELL HELMET	850,00 €
1311096	KC7-CMR FERNANDO ALONSO KARTING 59(7 3/8) CMR2016 BELL HELMET	850,00 €

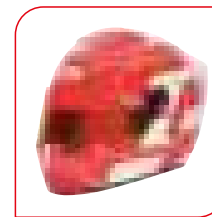

KC7-CMR CHARLES LECLERC KARTING		
1311141	KC7-CMR CHARLES LECLERC KARTING 54(6 3/4) CMR2016 BELL HELMET	850,00 €
1311142	KC7-CMR CHARLES LECLERC KARTING 55(6 7/8) CMR2016 BELL HELMET	850,00 €
1311143	KC7-CMR CHARLES LECLERC KARTING 56(7) CMR2016 BELL HELMET	850,00 €
1311144	KC7-CMR CHARLES LECLERC KARTING 57(7 1/8) CMR2016 BELL HELMET	850,00 €
1311145	KC7-CMR CHARLES LECLERC KARTING 58(7 1/4) CMR2016 BELL HELMET	850,00 €
1311146	KC7-CMR CHARLES LECLERC KARTING 59(7 3/8) CMR2016 BELL HELMET	850,00 €

CLASSIC



STAR CLASSIC		
1451001	STAR CLASSIC VINTAGE WHITE SML(57-58) FIA8859/SA2020 BELL HELMET	600,00 €
1451002	STAR CLASSIC VINTAGE WHITE MED(58-59) FIA8859/SA2020 BELL HELMET	600,00 €
1451003	STAR CLASSIC VINTAGE WHITE LRG(60-61) FIA8859/SA2020 BELL HELMET	600,00 €
1451004	STAR CLASSIC VINTAGE WHITE XLG(61-61+) FIA8859/SA2020 BELL HELMET	600,00 €



500-TX CLASSIC		
1450001	500-TX VINTAGE WHITE SML(57-58) FIA8859/SA2020 BELL HELMET	500,00 €
1450002	500-TX VINTAGE WHITE MED(58-59) FIA8859/SA2020 BELL HELMET	500,00 €
1450003	500-TX VINTAGE WHITE LRG(60-61) FIA8859/SA2020 BELL HELMET	500,00 €
1450004	500-TX VINTAGE WHITE XLG(61-61+) FIA8859/SA2020 BELL HELMET	500,00 €

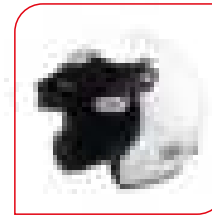

MAG-1		
1426051	MAG-1 WHITE (HANS) SML(57-58) FIA8859-2015 BELL HELMET	400,00 €
1426052	MAG-1 WHITE (HANS) MED(58-59) FIA8859-2015 BELL HELMET	400,00 €
1426053	MAG-1 WHITE (HANS) LRG(60-61) FIA8859-2015 BELL HELMET	400,00 €
1426054	MAG-1 WHITE (HANS) XLG(61-61+) FIA8859-2015 BELL HELMET	400,00 €

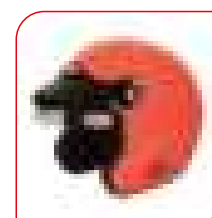

MAG-1 OFFSHORE		
1426A41	MAG-1 ORANGE SML(57-58) FIA8859-2015 BELL HELMET	400,00 €
1426A42	MAG-1 ORANGE MED(58-59) FIA8859-2015 BELL HELMET	400,00 €
1426A43	MAG-1 ORANGE LRG(60-61) FIA8859-2015 BELL HELMET	400,00 €
1426A44	MAG-1 ORANGE XLG(61-61+) FIA8859-2015 BELL HELMET	400,00 €

ACCESSORIES

SHIELD

SE07 3MM

2010411	SHIELD SE077 3MM - CLEAR DSAF BELL HELMET	140,00 €
2010412	SHIELD SE077 3MM - SMOKE DSAF BELL HELMET	140,00 €
2010413	SHIELD SE077 3MM - DARK DSAF BELL HELMET	140,00 €
2010428	SHIELD SE077 3MM - YELLOW DSAF BELL HELMET	140,00 €
2010415	SHIELD SE077 3MM - SILVER MIRROR DSAF BELL HELMET	170,00 €
2010416	SHIELD SE077 3MM - GOLD MIRROR DSAF BELL HELMET	170,00 €
2010417	SHIELD SE077 3MM - BLUE MIRROR DSAF BELL HELMET	170,00 €
2010418	SHIELD SE077 3MM - PINK/RED MIRROR DSAF BELL HELMET	170,00 €
2010426	SHIELD SE077 3MM - IRRIDIUM MIRROR DSAF BELL HELMET	170,00 €
2010419	SHIELD SE077 3MM - ML RED SMOKE DSAF BELL HELMET	195,00 €
2010420	SHIELD SE077 3MM - ML BLUE SMOKE DSAF BELL HELMET	195,00 €
2010421	SHIELD SE077 3MM - ML GREEN SMOKE DSAF BELL HELMET	195,00 €
2010422	SHIELD SE077 3MM - ML GOLD SMOKE DSAF BELL HELMET	195,00 €
2010429	SHIELD SE077 3MM - ML PURPLE SMOKE DSAF BELL HELMET	195,00 €

SE07 3MM

2010041	SHIELD SE07 3MM - CLEAR DSAF BELL HELMET	95,00 €
2010042	SHIELD SE07 3MM - SMOKE DSAF BELL HELMET	95,00 €
2010043	SHIELD SE07 3MM - DARK DSAF BELL HELMET	95,00 €
2010057	SHIELD SE07 3MM - YELLOW DSAF BELL HELMET	95,00 €
2010045	SHIELD SE07 3MM - SILVER MIRROR DSAF BELL HELMET	130,00 €
2010046	SHIELD SE07 3MM - GOLD MIRROR DSAF BELL HELMET	130,00 €
2010047	SHIELD SE07 3MM - BLUE MIRROR DSAF BELL HELMET	130,00 €
2010048	SHIELD SE07 3MM - SMOKE PINK/RED MIRROR DSAF BELL HELMET	130,00 €
2010049	SHIELD SE07 3MM - IRRIDIUM MIRROR DSAF BELL HELMET	130,00 €
2010050	SHIELD SE07 3MM - SMOKE ML RED DSAF BELL HELMET	150,00 €
2010051	SHIELD SE07 3MM - SMOKE ML BLUE DSAF BELL HELMET	150,00 €
2010052	SHIELD SE07 3MM - SMOKE ML GREEN DSAF BELL HELMET	150,00 €
2010056	SHIELD SE07 3MM - SMOKE ML GOLD DSAF BELL HELMET	150,00 €
2010058	SHIELD SE07 3MM - SMOKE ML PURPLE DSAF BELL HELMET	150,00 €

SE07 2MM

2010081	SHIELD SE07 2MM - CLEAR DSAF BELL HELMET	95,00 €
2010082	SHIELD SE07 2MM - SMOKE DSAF BELL HELMET	95,00 €
2010083	SHIELD SE07 2MM - DARK DSAF BELL HELMET	95,00 €
2010094	SHIELD SE07 2MM - YELLOW DSAF BELL HELMET	95,00 €
2010085	SHIELD SE07 2MM - SILVER MIRROR DSAF BELL HELMET	130,00 €
2010086	SHIELD SE07 2MM - GOLD MIRROR DSAF BELL HELMET	130,00 €
2010087	SHIELD SE07 2MM - BLUE MIRROR DSAF BELL HELMET	130,00 €
2010088	SHIELD SE07 2MM - PINK/RED MIRROR DSAF BELL HELMET	130,00 €
2010089	SHIELD SE07 2MM - IRRIDIUM MIRROR DSAF BELL HELMET	130,00 €
2010090	SHIELD SE07 2MM - SMOKE ML RED DSAF BELL HELMET	150,00 €

SE07 2MM

2010091	SHIELD SE07 2MM - SMOKE ML BLUE DSAF BELL HELMET	150,00 €
2010092	SHIELD SE07 2MM - SMOKE ML GREEN DSAF BELL HELMET	150,00 €
2010093	SHIELD SE07 2MM - CLEAR ML RED DSAF BELL HELMET	150,00 €
2010095	SHIELD SE07 2MM - SMOKE ML PURPLE DSAF BELL HELMET	150,00 €

SE07 EV 2MM

2010351	SHIELD SE07EV 2MM - CLEAR DSAF BELL HELMET	100,00 €
2010352	SHIELD SE07EV 2MM - SMOKE DSAF BELL HELMET	100,00 €
2010353	SHIELD SE07EV 2MM - YELLOW DSAF BELL HELMET	100,00 €
2010354	SHIELD SE07EV 2MM - BLUE MIRROR DSAF BELL HELMET	160,00 €
2010355	SHIELD SE07EV 2MM - SMOKE ML RED DSAF BELL HELMET	160,00 €

SE06 3MM

2010461	SHIELD SE06 3MM - CLEAR AS/AF BELL HELMET	95,00 €
2010462	SHIELD SE06 3MM - SMOKE AS/AF BELL HELMET	95,00 €
2010463	SHIELD SE06 3MM - DARK AS/AF BELL HELMET	95,00 €
2010464	SHIELD SE06 3MM - SILVER MIRROR AS/AF BELL HELMET	130,00 €
2010465	SHIELD SE06 3MM - GOLD MIRROR AS/AF BELL HELMET	130,00 €
2010466	SHIELD SE06 3MM - BLUE MIRROR AS/AF BELL HELMET	130,00 €
2010467	SHIELD SE06 3MM - PINK/RED MIRROR AS/AF BELL HELMET	130,00 €
2010468	SHIELD SE06 3MM - IRRIDIUM MIRROR AS/AF BELL HELMET	130,00 €
2010469	SHIELD SE06 3MM - SMOKE ML RED AS/AF BELL HELMET	150,00 €
2010470	SHIELD SE06 3MM - SMOKE ML BLUE AS/AF BELL HELMET	150,00 €
2010471	SHIELD SE06 3MM - SMOKE ML GREEN AS/AF BELL HELMET	150,00 €
2010472	SHIELD SE06 3MM - SMOKE ML PURPLE AS/AF BELL HELMET	150,00 €

SE06 3MM SUNSCREEN SHORT SHIELD

2010473	SUNSCREEN SHORT VISOR SE06 3MM - DARK AS/AF BELL HELMET	95,00 €
---------	---	---------

SE05 3MM

2010021	SHIELD SE05 3MM - CLEAR AS/AF BELL HELMET	70,00 €
2010022	SHIELD SE05 3MM - SMOKE AS/AF BELL HELMET	70,00 €
2010023	SHIELD SE05 3MM - DARK AS/AF BELL HELMET	70,00 €
2010024	SHIELD SE05 3MM - SILVER MIRROR BELL HELMET	95,00 €
2010025	SHIELD SE05 3MM - GOLD MIRROR BELL HELMET	95,00 €
2010026	SHIELD SE05 3MM - BLUE MIRROR BELL HELMET	95,00 €
2010027	SHIELD SE05 3MM - PINK/RED MIRROR BELL HELMET	95,00 €
2010028	SHIELD SE05 3MM - IRRIDIUM MIRROR BELL HELMET	95,00 €
2010031	SHIELD SE05 3MM - CLEAR DSAF - EYEPORT RUBBER MOLDING BELL HELMET	95,00 €
2010032	SHIELD SE05 3MM - SMOKE DSAF - EYEPORT RUBBER MOLDING BELL HELMET	95,00 €
2010033	SHIELD SE05 3MM - DARK DSAF - EYEPORT RUBBER MOLDING BELL HELMET	95,00 €
2010034	SHIELD SE05 3MM - SILVER MIRROR DSAF - EYEPORT RUBBER MOLDING BELL HELMET	130,00 €
2010035	SHIELD SE05 3MM - GOLD MIRROR DSAF - EYEPORT RUBBER MOLDING BELL HELMET	130,00 €
2010036	SHIELD SE05 3MM - BLUE MIRROR DSAF - EYEPORT RUBBER MOLDING BELL HELMET	130,00 €
2010037	SHIELD SE05 3MM - PINK/RED MIRROR DSAF - EYEPORT RUBBER MOLDING BELL HELMET	130,00 €
2010038	SHIELD SE05 3MM - IRRIDIUM MIRROR DSAF - EYEPORT RUBBER MOLDING BELL HELMET	130,00 €
2010039	SHIELD SE05 3MM - YELLOW DSAF - EYEPORT RUBBER MOLDING BELL HELMET	95,00 €

SE03 3MM

2010001	SHIELD SE03 3MM - CLEAR DSAF BELL HELMET	95,00 €
2010002	SHIELD SE03 3MM - SMOKE DSAF BELL HELMET	95,00 €
2010003	SHIELD SE03 3MM - DARK DSAF BELL HELMET	95,00 €
2010005	SHIELD SE03 3MM - SILVER MIRROR DSAF BELL HELMET	130,00 €
2010006	SHIELD SE03 3MM - GOLD MIRROR DSAF BELL HELMET	130,00 €
2010007	SHIELD SE03 3MM - BLUE MIRROR DSAF BELL HELMET	130,00 €
2010008	SHIELD SE03 3MM - PINK/RED MIRROR DSAF BELL HELMET	130,00 €
2010009	SHIELD SE03 3MM - IRRIDIUM MIRROR DSAF BELL HELMET	130,00 €
2010010	SHIELD SE03 3MM - ML RED DSAF BELL HELMET	150,00 €
2010011	SHIELD SE03 3MM - ML BLUE DSAF BELL HELMET	150,00 €
2010012	SHIELD SE03 3MM - ML GREEN DSAF BELL HELMET	150,00 €
2010013	SHIELD SE03 3MM - YELLOW DSAF BELL HELMET	95,00 €

ADJUSTABLE SUNSCREEN M10

2040141	ADJUSTABLE SUNSCREEN M10- SMOKE AS/AS BELL HELMET	55,00 €
2040142	ADJUSTABLE SUNSCREEN M10- DARK AS/AS BELL HELMET	55,00 €
2040143	ADJUSTABLE SUNSCREEN M10- AMBER AS/AS BELL HELMET	60,00 €
2040144	ADJUSTABLE SUNSCREEN M10- ML RED AS/AS BELL HELMET	65,00 €
2040145	ADJUSTABLE SUNSCREEN M10- MIRROR BLUE AS/AS BELL HELMET	60,00 €

STAR CLASSIC SHIELD

2010131	SHIELD STAR CLASSIC 3MM - CLEAR AS/AF BELL HELMET	95,00 €
2010132	SHIELD STAR CLASSIC 3MM - SMOKE AS/AF BELL HELMET	95,00 €

2150001	VISOR STRIP KIT (V10) WHITE BELL HELMET	9,00 €
2150002	VISOR STRIP KIT (V10) BLACK BELL HELMET	9,00 €
2150032	VISOR STRIP - LEWIS HAMILTON KARTING BELL HELMET	9,00 €
2150033	VISOR STRIP - FERNANDO ALONSO KARTING BELL HELMET	9,00 €
2150034	VISOR STRIP - CHARLES LECLERC KARTING BELL HELMET	9,00 €
2150045	VISOR STRIP - Ayrton Senna KARTING	9,00 €
2080001	HEX WRENCH KEY (V10) - BELL HELMET	10,00 €
2010219	DSAF INSERT V15 - SE05 EYEPORT RUBBER BELL HELMET	40,00 €

PEAK

2040001	PEAK KIT - MAG-1 BLACK V10 BELL HELMET	50,00 €
2040061	PEAK KIT - GT5/GT5 SPORT WHITE BELL HELMET	50,00 €
2040062	PEAK KIT - GT5/GT5 SPORT BLACK BELL HELMET	50,00 €
2040066	PEAK KIT - MAG/MAG RALLY NO PAINT BLACK BELL HELMET	50,00 €
2040130	PEAK KIT - HP10 MATTE CLEAR COAT BELL HELMET	90,00 €
2040131	PEAK KIT - MAG-10 CARBON CLEAR COAT BELL HELMET	90,00 €
2040132	PEAK KIT - MAG-10 WHITE BELL HELMET	55,00 €
2040133	PEAK KIT - MAG-10 ORANGE BELL HELMET	55,00 €
2040155	PEAK KIT - 6 SERIES BLACK MATTE BELL HELMET	65,00 €
2040156	PEAK KIT - 6 SERIES WHITE BELL HELMET	70,00 €
2040157	PEAK KIT - 500-TX BLACK GLOSSY BELL HELMET	50,00 €
2040161	PEAK KIT - X-1 NO PAINT BLACK BELL HELMET	50,00 €
2040002	SUN SCREEN LENS KIT - MAG-1 V10 BELL HELMET	15,00 €
2040091	SUN SCREEN LENS KIT - GT5/GT5 SPORT/HP5/MAG-9/HP9 BELL HELMET	15,00 €

PIVOT KIT

2020001	PIVOT KIT SV (SE03/SE05) - BLACK BELL HELMET	25,00 €
2020002	PIVOT KIT SV (SE03/SE05) - BLUE BELL HELMET	25,00 €
2020003	PIVOT KIT SV (SE03/SE05) - RED BELL HELMET	25,00 €
2020004	PIVOT KIT SV (SE03/SE05) - SILVER BELL HELMET	25,00 €
2020005	PIVOT KIT SV (SE03/SE05) - GOLD BELL HELMET	25,00 €
2020006	PIVOT KIT SV (SE03/SE05) - PURPLE BELL HELMET	25,00 €
2020007	PIVOT KIT SV (SE03/SE05) - GREEN BELL HELMET	25,00 €
2020008	PIVOT KIT SV (SE03/SE05) - PINK BELL HELMET	25,00 €
2020071	PIVOT KIT SV (SE07 - 3/2MM, SE077 3MM, SE06 3MM, SE07EV 2MM) - BLACK BELL HELMET	25,00 €
2020072	PIVOT KIT SV (SE07 - 3/2MM, SE077 3MM, SE06 3MM, SE07EV 2MM) - BLUE BELL HELMET	25,00 €
2020073	PIVOT KIT SV (SE07 - 3/2MM, SE077 3MM, SE06 3MM, SE07EV 2MM) - RED BELL HELMET	25,00 €
2020074	PIVOT KIT SV (SE07 - 3/2MM, SE077 3MM, SE06 3MM, SE07EV 2MM) - SILVER BELL HELMET	25,00 €
2020075	PIVOT KIT SV (SE07 - 3/2MM, SE077 3MM, SE06 3MM, SE07EV 2MM) - GOLD BELL HELMET	25,00 €
2020076	PIVOT KIT SV (SE07 - 3/2MM, SE077 3MM, SE06 3MM, SE07EV 2MM) - PURPLE BELL HELMET	25,00 €
2020077	PIVOT KIT SV (SE07 - 3/2MM, SE077 3MM, SE06 3MM, SE07EV 2MM) - GREEN BELL HELMET	25,00 €
2020078	PIVOT KIT SV (SE07 - 3/2MM, SE077 3MM, SE06 3MM, SE07EV 2MM) - PINK BELL HELMET	25,00 €
2020201	PIVOT KIT (10 SERIES) - BLACK BELL HELMET	25,00 €
2020202	PIVOT KIT (10 SERIES) - BLUE BELL HELMET	25,00 €
2020203	PIVOT KIT (10 SERIES) - RED BELL HELMET	25,00 €
2020204	PIVOT KIT (10 SERIES) - SILVER HELMET	25,00 €
2020041	PIVOT KIT STAR CLASSIC BELL HELMET	25,00 €
2020211	PIVOT KIT - MAG-1 V10 BELL HELMET	25,00 €
2020213	PIVOT KIT - MAG/MAG RALLY BELL HELMET	25,00 €
2020214	PIVOT KIT - X-1 BELL HELMET	25,00 €

AERO

2050032	REAR SPOILER - HP7/RS7/HP5/GT5/KC7(D&E) V15 F1 SML CLEAR BELL HELMET	80,00 €
2050033	REAR SPOILER - HP7/RS7/HP5/GT5 V15 F1 MED CLEAR BELL HELMET	80,00 €
2050034	REAR SPOILER - HP7/RS7/HP5/GT5 V15 F1 LRG CLEAR BELL HELMET	80,00 €
2050061	CHIN BAR GURNEY - HP7/HP77/RS7 MED CLEAR BELL HELMET	35,00 €
2050062	CHIN BAR GURNEY - HP7/HP77/RS7 LRG CLEAR BELL HELMET	35,00 €
2050063	CHIN BAR GURNEY - HP7/HP77/RS7 XLG CLEAR BELL HELMET	35,00 €
2050081	TOP GURNEY - HP7/HP77/RS7 V10 SML(4MM) CLEAR BELL HELMET	35,00 €
2050083	TOP GURNEY - HP7/HP77/RS7 V10 LRG(6.55MM) CLEAR BELL HELMET	35,00 €
2050093	WING KIT - GTX.3 (V10) CARBON LOOK FINISH BELL HELMET	60,00 €

HANS

2100001	HANS CLIP SET SILVER FIA8858-2010 - BELL HELMET	65,00 €
2100002	HANS CLIP SET BLACK FIA8858-2010 - BELL HELMET	85,00 €
2100003	HANS CLIP SET BLUE FIA8858-2010 - BELL HELMET	85,00 €
2100004	HANS CLIP SET GREEN FIA8858-2010 - BELL HELMET	85,00 €
2100005	HANS CLIP SET RED FIA8858-2010 - BELL HELMET	85,00 €
2100006	HANS CLIP SET PINK FIA8858-2010 - BELL HELMET	85,00 €
2100007	HANS CLIP SET GOLD FIA8858-2010 - BELL HELMET	85,00 €
2100008	HANS CLIP SET PURPLE FIA8858-2010 - BELL HELMET	85,00 €

FORCED AIR

2070243	FORCED AIR TOP EYEPORT KIT HP77/HP7/RS7/HP5/GT5 SPORT CLEAR + NOZZLE V05 45 DEGREE	145,00 €
2070244	FORCED AIR TOP EYEPORT KIT HP77/HP7/RS7/HP5/GT5 SPORT CLEAR + NOZZLE V05 90 DEGREE	145,00 €
2070091	FORCED AIR TOP EYEPORT KIT HP77/HP7/RS7/HP5/GT5 SPORT CLEAR + NOZZLE V05 180 DEGREE	145,00 €
2070099	FORCED AIR TOP EYEPORT KIT HP77/HP7/RS7/HP5/GT5 SPORT CLEAR + NOZZLE V10 QUICK LOCK	145,00 €
2070238	FORCED AIR TOP 8 HOLES KIT HP77/HP7/RS7 CARBON + NOZZLE V05 45 DEGREE	160,00 €
2070237	FORCED AIR TOP 8 HOLES KIT HP77/HP7/RS7 CARBON + NOZZLE V05 90 DEGREE	160,00 €
2070112	FORCED AIR TOP 8 HOLES KIT HP77/HP7/RS7 CARBON + NOZZLE V05 180 DEGREE	160,00 €
2070120	FORCED AIR TOP 8 HOLES KIT HP77/HP7/RS7 CARBON + NOZZLE V10 QUICK LOCK	160,00 €
2070240	FORCED AIR TOP 10 HOLES KIT RS7 CARBON + NOZZLE V05 45 DEGREE	160,00 €
2070239	FORCED AIR TOP 10 HOLES KIT RS7 CARBON + NOZZLE V05 90 DEGREE	160,00 €
2070132	FORCED AIR TOP 10 HOLES KIT RS7 CARBON + NOZZLE V05 180 DEGREE	160,00 €
2070140	FORCED AIR TOP 10 HOLES KIT RS7 CARBON + NOZZLE V10 QUICK LOCK	160,00 €
2070245	FORCED AIR TOP 10 HOLES KIT RS7 CLEAR + NOZZLE V05 45 DEGREE	150,00 €
2070246	FORCED AIR TOP 10 HOLES KIT RS7 CLEAR + NOZZLE V05 90 DEGREE	150,00 €
2070131	FORCED AIR TOP 10 HOLES KIT RS7 CLEAR + NOZZLE V05 180 DEGREE	150,00 €
2070139	FORCED AIR TOP 10 HOLES KIT RS7 CLEAR + NOZZLE V10 QUICK LOCK	150,00 €
2070171	FORCED AIR TOP-LOW KIT HP7/HP77/RS7/GT5 SPORT CARBON + NOZZLE AIR STANDARD	160,00 €
2070242	FORCED AIR TOP/SIDE KIT HP7/HP77/RS7 CLEAR + NOZZLE V05 45 DEGREE	170,00 €
2070241	FORCED AIR TOP/SIDE KIT HP7/HP77/RS7 CLEAR + NOZZLE V05 90 DEGREE	170,00 €
2070204	FORCED AIR TOP/SIDE KIT HP7/HP77/RS7 CLEAR + NOZZLE V05 180 DEGREE	170,00 €
2070205	FORCED AIR TOP/SIDE KIT HP7/HP77/RS7 CLEAR + NOZZLE V10 QUICK LOCK	170,00 €
2070312	COVER PLATE & FORCED AIR LOW PROFILE NOZZLE - HP6/GT6 CLEAR BELL HELMET	50,00 €
2070313	COVER PLATE & FORCED AIR QL NOZZLE - HP6/GT6 CLEAR BELL HELMET	50,00 €
2070061	NOZZLE V05 180 DEGREE. Ø 31mm BELL HELMET	13,00 €
2070062	NOZZLE V05 20 DEGREE. Ø 31mm BELL HELMET	13,00 €
2070063	NOZZLE V05 45 DEGREE. Ø 31mm BELL HELMET	13,00 €
2070064	NOZZLE V05 90 DEGREE. Ø 31mm BELL HELMET	13,00 €
2070065	NOZZLE V10 QUICK LOCK. Ø 23mm BELL HELMET	13,00 €
2070066	ADAPTOR V10 QL 180 DEGREE BELL HELMET	25,00 €
2070067	ADAPTOR V10 QL 90 DEGREE BELL HELMET	25,00 €

MLA1000	MAGLOCK AIR FULL KIT	245,00 €
MLA1001	MAGLOCK HELMET SIDE	90,00 €
MLA1003	MAGLOCK HOSE SIDE	165,00 €

DRINKING TUBE KITS

2080063	DRINKING TUBE KIT BELL HELMET	20,00 €
2081821	DRINKING TUBE KIT WITH QUICK CONNECT VALVE BELL HELMET	85,00 €

TEAR-OFFS

2030001	TEAR-OFFS - SE03/SE05 HQ 0.25MM (PACK OF 10) BELL HELMET	30,00 €
2030002	TEAR-OFFS - SE07 HQ 0.25MM (PACK OF 10) BELL HELMET	30,00 €
2030003	TEAR-OFFS - SE077 HQ 0.25MM (PACK OF 10) BELL HELMET	30,00 €
2030004	TEAR-OFFS - 276/281 HQ 0.25MM (PACK OF 10) BELL HELMET	30,00 €
2030082	TEAR-OFFS POST KIT - SE SHEILD 3MM BLACK (PLASTIC) BELL HELMET	5,00 €
2030083	TEAR-OFFS POST KIT - SE SHIELD 2MM BLACK (PLASTIC) BELL HELMET	5,00 €
2030103	TEAR-OFFS - SE06 HQ 0.25MM (PACK OF 10) BELL HELMET	30,00 €
10235C	SE07 TEAR-OFFS (VP) RACING OPTICS X STACK (10) 2MIL	50,00 €
3435C4	SE07 TEAR-OFFS (VP) RACING OPTICS SPEEDSTACK(3) 4MIL	35,00 €

CLEANING KITS

2080009	HELMET CLEANING KIT - BELL	30,00 €
2080010	HELMET CLEANER 99ML BELL HELMET	10,00 €
2080011	SHIELD CLEANER 99ML BELL HELMET	10,00 €
2080012	HELMET INTERIOR CLEANER 99ML BELL HELMET	10,00 €
2080013	CLEANING CLOTH - GREY (V14) BELL HELMET	10,00 €

AIR INTAKE

2060003	MANUAL LEVER VENT KIT - GP3/M8 V16 CLEAR (3 PCS) BELL HELMET	30,00 €
2060011	CIRCLE GROMMET VENT KIT (12 PCS) BELL HELMET	15,00 €
2060013	CIRCLE GROMMET VENT PLUG KIT BLACK (10 PCS) BELL HELMET	15,00 €
2060041	AIR INTAKE CENTRAL KIT - HP7/HP77/RS7/HP5/GT5/KC7 CLEAR (2 PART) BELL HLEMET	35,00 €
2060042	AIR INTAKE SIDE KIT - HP7/HP77/RS7/HP5/GT5/KC7 CLEAR (2 PCS) BELL HELMET	30,00 €
2060043	AIR INTAKE SIDE EXTRACTORS KIT - HP7/HP77/RS7/HP5/GT5/KC7 CLEAR (2 PCS) BELL HELMET	30,00 €
2060044	AIR INTAKE KIT - HP7/HP77/HP7/RS7/HP5/GT5/KC7 CLEAR (4 PCS) BELL HELMET	60,00 €
2060045	AIR INTAKE LOW PROFILE KIT - HP7/HP77/RS7/HP5/GT5/KC7 CLEAR (2 PCS) BELL HELMET	30,00 €
2060072	AIR INTAKE CENTER KIT - HP7/HP77/RS7/KC7 V19 CLEAR (1PCS) BELL HELMET	35,00 €

REPLACEMENT KITS

2081801	HALF CHIN BAR KIT - CARBON MATTE CLEAR COAT (HP10) BELL HELMET	215,00 €
2081802	HALF CHIN BAR KIT - CARBON CLEAR COAT (MAG-10) BELL HELMET	200,00 €
2081803	HALF CHIN BAR KIT - WHITE (MAG-10) BELL HELMET	145,00 €
2081804	HALF CHIN BAR KIT - ORANGE (MAG-10) BELL HELMET	145,00 €
2081811	SIDE COVER KIT - HP10 CARBON MATTE FINISH BELL HELMET	75,00 €
2081812	SIDE COVER KIT - MAG-10 CARBON GLOSS FINISH BELL HELMET	65,00 €
2081813	SIDE COVER KIT - MAG-10 PRO WHITE BELL HELMET	45,00 €
2081815	SIDE F. CONNECTOR KIT - ABS BLACK (HP10/MAG10 RALLY) BELL HELMET	50,00 €
2081817	SIDE F. CONNECTOR KIT - ABS WHITE (HP10/MAG10 RALLY) BELL HELMET	50,00 €
2081823	FULL CHIN BAR KIT - CARBON MATTE CLEAR COAT HP10/HP10 RALLY BELL HELMET	315,00 €
2081824	FULL CHIN BAR KIT - CARBON CLEAR COAT MAG-10/MAG-10 RALLY CARBON BELL HELMET	315,00 €
2081825	HALF CHIN BAR SHORT KIT - CARBON MATTE CLEAR COAT (HP10) BELL HELMET	215,00 €
2081826	HALF CHIN BAR SHORT KIT - CARBON CLEAR COAT (MAG-10) BELL HELMET	200,00 €
2081828	SEALING CHIN BAR COVER KIT - RUBBER - X-1 BELL HELMET	29,00 €
2020082	SCREW KIT - HCB HP10/MAG-10 RALLY BELL HELMET	25,00 €
2081820	FOAM KIT - HCB HP10/MAG-10 RALLY BELL HELMET	25,00 €
2081828	SEALING CHIN BAR COVER KIT - RUBBER - X-1 BELL HELMET	29,00 €
2090001	RUBBER PROFILE KIT - TRIM EDGE THIN (V10) 8MM 1.7M BLACK BELL HELMET	20,00 €
2090002	RUBBER PROFILE KIT - TRIM EDGE THIN (V10) 10MM 1.7M BLACK BELL HELMET STAR CLASSIC	20,00 €
2090011	RUBBER PROFILE KIT - VISOR EYEPORTE EDGE 77CM BLACK BELL HELMET	20,00 €
2090021	RUBBER PROFILE KIT - TRIM EDGE THIN (V10) 8MM 1M BLACK BELL HELMET	20,00 €
2090031	RUBBER PROFILE KIT - TRIM EDGE ADVANCED 1M BLACK BELL HELMET	20,00 €
2090033	RUBBER PROFILE KIT - TRIM EDGE ADVANCED 1M WHITE BELL HELMET	25,00 €
2090050	RUBBER PROFILE KIT - VISOR EYEPORTE EDGE 77CM WHITE BELL HELMET	25,00 €
2090061	RUBBER PROFILE KIT - TRIM EDGE 500-TX (V10) 1.4M BELL HELMET	20,00 €
2081644	TOP PAD - 20MM (57-59) V20 BELL HELMET	13,00 €
2081645	TOP PAD - 20MM (60-61+) V20 BELL HELMET	13,00 €
2080002	EYEPORTE TAPE FOAM BELL HELMET	10,00 €
2080xxx	INT. PARTS KIT BLACK/GREY BELL HELMET	85,00 €
2080xxx	INT. PARTS KIT COLORED BELL HELMET	95,00 €
218xxxx	INTERIOR KIT BLACK/GREY BELL HELMET*	405,00 €
218xxxx	INTERIOR KIT COLORED INTERIOR BELL HELMET*	590,00 €
2170006	INTERIOR FULL KIT REBUILD SERVICE CHARGE (Complimentary to SKU 218xxxx)	95,00 €

*Interior Kit rebuilt charges doesn't include the interior kit

HELMET DRYER

2081295	HELMET DRYER - BELL HELMET	190,00 €
---------	----------------------------	----------

BAGS

2120001	HP HELMET BAG (38x29x27CM) BLACK BELL HELMET W/ SHOULDER STRAP	60,00 €
2120002	HELMET & HANS BAG (42x40x33CM) BLACK QUILTED BELL HELMET	85,00 €
2120003	HELMET & GEAR BAG (41x56x36CM) BELL HELMET	100,00 €
2120004	TROLLEY TRAVEL BAG MED (70X34X32CM) RED/BLACK BELL HELMET	135,00 €
2120005	TROLLEY GEAR BAG LRG (93X38X36CM) BLACK QUILTED 93X38X36CM BELL HELMET	175,00 €
2120011	DRAW STRING HELMET BAG (V10) BELL HELMET	13,00 €
2120023	DRAWSTRING HELMET BAG (V21) BELL HELMET	15,00 €
2120024	BELL TROLLEY TRAVEL BAG - SMALL	105,00 €
2120025	BELL TROLLEY TRAVEL BAG - LARGE	150,00 €
2120026	BELL BACKPACK	80,00 €
2120027	BELL TROLLEY TRAVEL BAG - MEDIUM	130,00 €

APPAREL

2130001	CAP ADJUSTABLE - BELL HELMET	30,00 €
2130011	CAP FLEXFIT S/M - BELL HELMET	30,00 €
2130012	CAP FLEXFIT L/XL - BELL HELMET	30,00 €
2130211	T-SHIRT BLACK W/BELL LOGO SML - BELL HELMET	30,00 €
2130212	T-SHIRT BLACK W/BELL LOGO MED - BELL HELMET	30,00 €
2130213	T-SHIRT BLACK W/BELL LOGO LRG - BELL HELMET	30,00 €
2130214	T-SHIRT BLACK W/BELL LOGO XLG - BELL HELMET	30,00 €
2130215	T-SHIRT BLACK W/BELL LOGO 2XL - BELL HELMET	30,00 €
2130221	T-SHIRT GREY 6400 SPORT SML - BELL HELMET	30,00 €
2130222	T-SHIRT GREY 6400 SPORT MED - BELL HELMET	30,00 €
2130223	T-SHIRT GREY 6400 SPORT LRG - BELL HELMET	30,00 €
2130224	T-SHIRT GREY 6400 SPORT XLG - BELL HELMET	30,00 €
2130225	T-SHIRT GREY 6400 SPORT 2XL - BELL HELMET	30,00 €
2130231	T-SHIRT ASH 8000 SML - BELL HELMET	30,00 €
2130232	T-SHIRT ASH 8000 MED - BELL HELMET	30,00 €
2130233	T-SHIRT ASH 8000 LRG - BELL HELMET	30,00 €
2130234	T-SHIRT ASH 8000 XLG - BELL HELMET	30,00 €
2130235	T-SHIRT ASH 8000 2XL - BELL HELMET	30,00 €
2130241	T-SHIRT DARK 8000 HEATHER SML - BELL HELMET	30,00 €
2130242	T-SHIRT DARK 8000 HEATHER MED - BELL HELMET	30,00 €
2130243	T-SHIRT DARK 8000 HEATHER LRG - BELL HELMET	30,00 €
2130244	T-SHIRT DARK 8000 HEATHER XLG - BELL HELMET	30,00 €
2130245	T-SHIRT DARK 8000 HEATHER 2XL - BELL HELMET	30,00 €
2130251	T-SHIRT GUN METAL 67000 SML - BELL HELMET	30,00 €
2130252	T-SHIRT GUN METAL 67000 MED - BELL HELMET	30,00 €
2130253	T-SHIRT GUN METAL 67000 LRG - BELL HELMET	30,00 €
2130254	T-SHIRT GUN METAL 67000 XLG - BELL HELMET	30,00 €
2130255	T-SHIRT GUN METAL 67000 2XL - BELL HELMET	30,00 €

2130261	HOODIE BLACK SS4500 SML - BELL HELMET	45,00 €
2130262	HOODIE BLACK SS4500 MED - BELL HELMET	45,00 €
2130263	HOODIE BLACK SS4500 LRG - BELL HELMET	45,00 €
2130264	HOODIE BLACK SS4500 XLG - BELL HELMET	45,00 €
2130265	HOODIE BLACK SS4500 2XL - BELL HELMET	45,00 €
2130271	HOODIE FOREST CAMO SS4500 SML - BELL HELMET	45,00 €
2130272	HOODIE FOREST CAMO SS4500 MED - BELL HELMET	45,00 €
2130273	HOODIE FOREST CAMO SS4500 LRG - BELL HELMET	45,00 €
2130274	HOODIE FOREST CAMO SS4500 XLG - BELL HELMET	45,00 €
2130275	HOODIE FOREST CAMO SS4500 2XL - BELL HELMET	45,00 €

CUSTOM PAINTING & SERVICES

2170031	PAINTING JOB LEVEL 1	740,00 € *
2170032	PAINTING JOB LEVEL 2	1.110,00 € *
2170033	PAINTING JOB LEVEL 3	1.480,00 € *
2170034	PAINTING JOB LEVEL 4	1.850,00 € *
2170011	GRAPHICS DEVELOPMENT DESIGN ONE VIEW	120,00 € *
2170011	GRAPHICS DEVELOPMENT DESIGN FULL VIEW	320,00 € *
2170011	GRAPHICS DEVELOPMENT AMENDMENT (PER UNIT / PER AMENDMENT)	50,00 € *
2170035	ADDITIONAL CHARGE CHROME	260,00 € *
2170038	ADDITIONAL CHARGE PAINT SPOILER/PEAK	120,00 € *
2170039	ADDITIONAL CHARGE PAINT AIR INTAKE	65,00 € *
2170040	ADDITIONAL CHARGE CHROME SPOILER/PEAK	65,00 € *
2170041	ADDITIONAL CHARGE CHROME AIR INTAKE	40,00 € *
2170043	ADDITIONAL CHARGE USED HELMET	90,00 € *

SERVICE CHARGE

2170006	INTERIOR FULL KIT REBUILD SERVICE CHARGE (Complimentary to SKU 218xxxx)	95,00 € *
2170050	INTERIOR KIT ASSEMBLY CHARGE (After painted shell)	215,00 € *
2170084	REPLACEMENT SERVICE BELL HELMET (Hans post anchor-drinking tube-chinstrap-radio kit)	30,00 € *

* Reduced discount

COMMUNICATION DEVICES

6100041	AMPLIFIER FEARLESS WIRELESS - DIGITAL- MALE 4 PIN NEXUS	800,00 €
6100042	WIRELESS MODULE AND SIDE COVER	370,00 €
6100036	AMPLIFIER FEARLESS WRC	1.150,00 €
6100037	WIRING AMPLIFIER FEARLESS WRC	380,00 €
6100008	AMPLIFIER FEARLESS - DIGITAL - MALE 4 PIN NEXUS	428,00 €
6100009	AMPLIFIER FEARLESS - DIGITAL - FEMALE 4 PIN NEXUS	428,00 €
6100010	AMPLIFIER FEARLESS - DIGITAL - FEMALE 4 PIN NEXUS (COMP. IMSA)	428,00 €
6100038	AMPLIFIER FURY - DIGITAL - MALE 4 PIN NEXUS	285,00 €
6100039	AMPLIFIER FURY - DIGITAL - FEMALE 4 PIN NEXUS	285,00 €
6100040	AMPLIFIER FURY - DIGITAL - FEMALE 4 PIN NEXUS (COMP. IMSA)	285,00 €
6100002	AMPLIFIER BRAVE- ANALOG - MALE 4 PIN NEXUS	183,00 €
6100003	AMPLIFIER BRAVE- ANALOG- FEMALE 4 PIN NEXUS	183,00 €
6100004	AMPLIFIER BRAVE- ANALOG- FEMALE 4 PIN NEXUS (COMP. IMSA)	183,00 €
6200002	HEADSET ZERONOISE- FEMALE 4 PIN NEXUS	190,00 €
6200003	HEADSET ZERONOISE- MALE 4 PIN NEXUS	190,00 €
6200004	HEADSET ZERONOISE- MALE 4 PIN NEXUS (COMP. IMSA)	190,00 €
6200010	WIRING FOR HEADSET WW - FEMALE NEXUS 4 PIN STD	85,00 €
6300034	EARCUPS WITH SPEAKERS - RCA MALE (CINCH CONNECTOR) for full face helmets	79,00 €
6300035	EARCUPS WITH SPEAKERS - 3.5 MM STEREO PLUG for full face helmets	79,00 €
6300028	SEMICUSTOM EARPLUGS WITH SHORT EAR CANAL AND CLEANING KIT (3.5MM MALE CONNECTOR)	220,00 €
6300029	SEMICUSTOM EARPLUGS WITH LONG EAR CANAL AND CLEANING KIT (3.5MM MALE CONNECTOR)	220,00 €
6300031	SEMICUSTOM EARPLUGS WITH SHORT EAR CANAL AND CLEANING KIT (RCA MALE CONNECTOR)	220,00 €
6300032	SEMICUSTOM EARPLUGS WITH LONG EAR CANAL AND CLEANING KIT (RCA MALE CONNECTOR)	220,00 €
6100026	AMP. PIT-LINK-BT MALE NEXUS (BLUETOOTH)	510,00 €
6100027	AMP. PIT-LINK-BT FEMALE NEXUS (BLUETOOTH)	510,00 €
6100028	AMP. PIT-LINK-BT FEMALE NEXUS (BLUETOOTH) (IMSA)	510,00 €
6100013	SINGLE PTT BUTTON WITH USB-C CONNECTOR (LENGTH 2M)	28,00 €
6100014	DOUBLE PTT BUTTON WITH USB-C CONNECTOR (FOR DRIVER AND CO-DRIVER, LENGTH 2M)	56,00 €
6200005	HEADSET PIT-LINK - JACK 3.5MM - SMARTPHONE COMP - WITH PTT BUTTON - ANDROID	269,00 €
6200006	HEADSET PIT-LINK - JACK 3.5MM - SMARTPHONE COMP - WITH PTT BUTTON - IPHONE	269,00 €
6300030	EARPLUGS KIT WITH FOAM TIPS (3.5MM MALE CONNECTOR)	158,00 €
6300033	EARPLUGS KIT WITH FOAM TIPS (RCA MALE CONNECTOR)	158,00 €
6100029	AMPLIFIER VALIANT - ENTRY LEVEL AMPLIFIER - FEMALE JACK STEREO 6.35MM CONN.	84,00 €
6200001	HEADSET VALIANT - MALE JACK STEREO 6.35MM CONN.	140,00 €
6100018	AMPLIFIER COVER RED - SMOOTH	22,00 €
6100019	AMPLIFIER COVER RED - RUGGED	28,00 €
6100030	AMPLIFIER COVER BLACK - RUGGED	28,00 €
6100035	AMPLIFIER COVER GREY - RUGGED	28,00 €

6400017	AMPLIFIER SOUND FILTER 12V	42,00 €
6400019	REPLACEMENT FOAM TIPS FOR EARPLUGS	6,00 €
6400024	REPLACEMENT MICROPHONE FOAM COVER	5,00 €
6400025	BOX RADIO ADAPTER	175,00 €
6400026	BOX RADIO ADAPTER + POWER FILTER	235,00 €
6400027	BOX POWER FILTER MY2024	85,00 €
6100031	AMPLIFIER-KART (STAND ALONE AMPLIFIER)	158,00 €
6300030	EARPLUGS KIT WITH FOAM TIPS (3.5MM MALE CONNECTOR)	158,00 €
6300026	USB-C CONNECTOR FOR PIT-LINK TRAINER - WITH 3.5MM STEREO CONNECTOR FOR EARPLUGS	131,00 €
6200005	HEADSET PIT-LINK-JACK 3.5MM - SMARTPHONE COMP - WITH PTT BUTTON - ANDROID	269,00 €
6200006	HEADSET PIT-LINK-JACK 3.5MM - SMARTPHONE COMP - WITH PTT BUTTON - IPHONE	269,00 €
6200007	HEADSET PIT-LINK - USB-C - WITH PTT BUTTON (WITH BLUETOOTH AMPLIFIER)	350,00 €
6100024	AMPLIFIER-KART PRO KIT (W/ USB-C BLUETOOTH HEADSET)	597,00 €
6100032	AMPLIFIER-KART PRO KIT (W/ ANDROID HEADSET)	522,00 €
6100034	AMPLIFIER-KART PRO KIT (W/ IPHONE HEADSET)	522,00 €
6100033	AMPLIFIER-KART BASIC KIT (NO HEADSET)	312,00 €

RADIO HELMET KIT FOR OPEN FACE HELMET

6300001	FEMALE NEXUS 4 PIN STD - WITH MICROPHONE FLEX BOOM - WITH EARCUPS	199,00 €
6300002	FEMALE NEXUS 4 PIN STD - WITH MICROPHONE FLEX BOOM - NO EARCUPS	79,00 €
6300003	FOR HALF CHIN BAR - FEMALE NEXUS 4 PIN STD - NO MICROPHONE FLEX BOOM - WITH EARCUPS	199,00 €
6300004	MALE NEXUS 4 PIN STD - WITH MICROPHONE FLEX BOOM - WITH EARCUPS	199,00 €
6300005	MALE NEXUS 4 PIN STD - WITH MICROPHONE FLEX BOOM - NO EARCUPS	83,00 €
6300006	MALE NEXUS 4 PIN IMSA - WITH MICROPHONE FLEX BOOM - WITH EARCUPS	199,00 €
6300007	MALE NEXUS 4 PIN IMSA - WITH MICROPHONE FLEX BOOM - NO EARCUPS	83,00 €
6300008	STEREO CONNECTOR 6.35MM - WITH MICROPHONE FLEX BOOM - NO EARCUPS	35,00 €
6300024	MALE NEXUS 4 PIN STD - WITH MICROPHONE FLEX BOOM - WITH RCA CONNECTOR FOR EARPLUGS	179,00 €
6300025	MALE NEXUS 4 PIN STD - WITH MICROPHONE FLEX BOOM - WITH 3.5mm CONNECTOR FOR EARPLUGS	179,00 €

RADIO HELMET KIT FOR FULL FACE HELMET

6300009	MALE NEXUS 4 PIN STD - WITH EARCUPS	199,00 €
6300010	MALE NEXUS 4 PIN STD - WITH INTEGRATED SPEAKER PADS	83,00 €
6300011	MALE NEXUS 4 PIN STD - WITH RCA CONNECTOR FOR EARPLUGS	179,00 €
6300012	MALE NEXUS 4 PIN STD - WITH 3.5MM STEREO CONNECTOR FOR EARPLUGS	179,00 €
6300013	MALE NEXUS 5 PIN STD - WITH RCA CONNECTOR FOR EARPLUGS	199,00 €
6300014	MALE NEXUS 4 PIN IMSA - WITH EARCUPS	199,00 €
6300015	MALE NEXUS 4 PIN IMSA - WITH INTEGRATED SPEAKER PADS	83,00 €
6300016	MALE NEXUS 4 PIN IMSA - WITH RCA CONNECTOR FOR EARPLUGS	179,00 €
6300017	MALE NEXUS 4 PIN IMSA - WITH 3.5MM STEREO CONNECTOR FOR EARPLUGS	179,00 €
6300018	MALE NEXUS 5 PIN IMSA - WITH RCA CONNECTOR FOR EARPLUGS	199,00 €
6300019	STEREO CONNECTOR 6.35MM - WITH INTEGRATED SPEAKER PADS	32,00 €
6300026	USB-C CONNECTOR FOR PIT-LINK TRAINER - WITH 3.5MM STEREO CONNECTOR FOR EARPLUGS	131,00 €
6300023	FEMALE NEXUS 4 PIN STD - WITH INTEGRATED SPEAKER PADS	83,00 €
6300027	FEMALE NEXUS 4 PIN STD - WITH EARCUPS	199,00 €
6300034	EARCUPS WITH SPEAKERS - RCA MALE (CINCH CONNECTOR)	79,00 €
6300035	EARCUPS WITH SPEAKERS - 3.5 MM STEREO PLUG	79,00 €
6300036	WIRELESS RADIO KIT 10 SERIES	199,00 €

ADAPTORS

6400004	ADAPTER CROSSED WIRING L=15CM - COILED CABLE - M/NEXUS 4 PIN STD: M/NEXUS 4 PIN STD	70,00 €
6400005	ADAPTER CROSSED WIRING L=15CM - COILED CABLE - F/NEXUS 4 PIN STD : F/NEXUS 4 PIN STD	70,00 €
6400006	ADAPTER EXTENSION L=150CM - COILED CABLE - M/NEXUS 4 PIN STD : F/NEXUS 4 PIN STD	70,00 €
6400007	ADAPTER CROSSED WIRING L=15CM - COILED CABLE - M/NEXUS 4 PIN STD : M/NEXUS 4 PIN IMSA	70,00 €
6400008	ADAPTER CROSSED WIRING L=15CM - COILED CABLE - F/NEXUS 4 PIN STD : F/NEXUS 4 PIN IMSA	70,00 €
6400009	ADAPTER CROSSED WIRING L=15CM - COILED CABLE - M/NEXUS 4 PIN STD : F/NEXUS 4 PIN IMSA	70,00 €
6400010	ADAPTER - L=50CM - M/NEXUS 4 PIN STD : M/JACK3.5 FOR SMARTPHONE	81,00 €
6400011	ADAPTER - L=50CM - F/NEXUS 4 PIN STD : M/JACK3.5 FOR SMARTPHONE	81,00 €
6400012	ADAPTER - L=15CM - F/NEXUS 4 PIN STD : M/NEXUS 5 PIN STD	81,00 €
6400013	ADAPTER - L=15CM - M/NEXUS 4 PIN STD : M/NEXUS 5 PIN STD	81,00 €
6400014	ADAPTER - L=15CM - F/NEXUS 4 PIN IMSA: M/NEXUS 5 PIN IMSA	81,00 €
6400021	ADAPTER EXTENSION L=15CM - COILED CABLE - FEMALE 4 PIN STD+RCA : MALE 4 PIN STD	99,00 €
6400022	ADAPTER CROSSED WIRING L=15CM-COILED CABLE - MALE 4 PIN STD+RCA : MALE 4 PIN STD	99,00 €
6400023	ADAPTER CROSSED WIRING L=15CM-COILED CABLE - FEMALE 4 PIN STD+RCA : FEMALE 4 PIN STD	99,00 €
6400015	CONNECTOR NEXUS - MALE 4 PIN	25,00 €
6400016	CONNECTOR NEXUS - FEMALE 4 PIN	35,00 €



SCAN TO DOWNLOAD
DIGITAL VERSION



RACING FORCE GROUP



Listed
Euronext Growth Milan (RFG)
Euronext Growth Paris (ALRFG)



SINCE 1973



ompracing.com

RACINGFORCEGROUP

Brands that beat with the same racing heart





RACING SPIRIT CREW LINE



Racing Spirit
racingspirit.com

RACINGFORCEGROUP

Brands that beat with the same racing heart



INDEX

A	_____
82	Aero - Accessories
88	Air Intake - Accessories
B	_____
92	Bags - Accessories
C	_____
07	Circuit Full Face - Helmets Section
41	Circuit Open Face - Helmets Section
69	Classic - Helmets Section
87	Cleaning Kits - Accessories
F	_____
84	Forced Air - Accessories
H	_____
83	Hans - Accessories
I	_____
83	Interior- Accessories
K	_____
51	Karting - Helmets Section
P	_____
80	Peak Kit - Accessories
81	Pivot Kit - Accessories
R	_____
27	Rally - Helmets Section
90	Replacement Kits - Accessories
S	_____
76	Shield - Accessories
T	_____
87	Tear-offs - Accessories
Z	_____
99	Zeronoise Communication devices



A BRAND OF

RACING
FORCE
GROUP



CONTACT US

RACING FORCE INTERNATIONAL WLL

PO Box 90344,
Bldg. 310, Road 6204
1062 Sakhir, Bahrain
Phone: +973 17 839 999
Email: info.rfi@racingforce.com
bellracing.com

RACING FORCE S.p.A. (Headquarter)

Via E. Bazzano, 5
16019 Ronco Scrivia (GE) Italy
Phone: +39 010 96501
Fax: +39 010 935698
Email: info.rf@racingforce.com
ompracing.com



MOTORSPORT EXPORT SALES

Phone: +39 0109650150
Fax: +39 010 935698
Email: exportsales.rf@racingforce.com
Phone: +973 17 839 999 (BAHRAIN)
Email: info.rfi@racingforce.com (BAHRAIN)



MOTORSPORT ITALIAN SALES

Phone: +39 010 9650147
Fax: +39 010 93505808
Email: vendite.italia@racingforce.com



KART SALES

Phone: +39 010 9650147
Fax: +39 010 93505808
Email: kartsales.rf@racingforce.com

BELL is a registered trademark owned by Bell Sports, Inc, and licensed to Racing Force

Please check on www.bellracing.com to find the official Bell Racing distributors around the world and the commercial terms.