

TRACK COMPONENTS

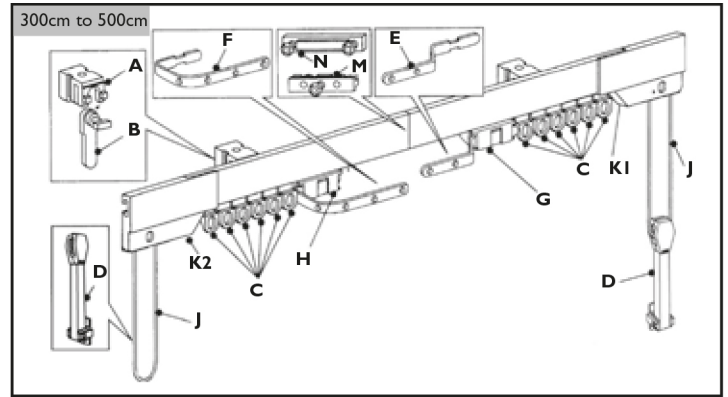
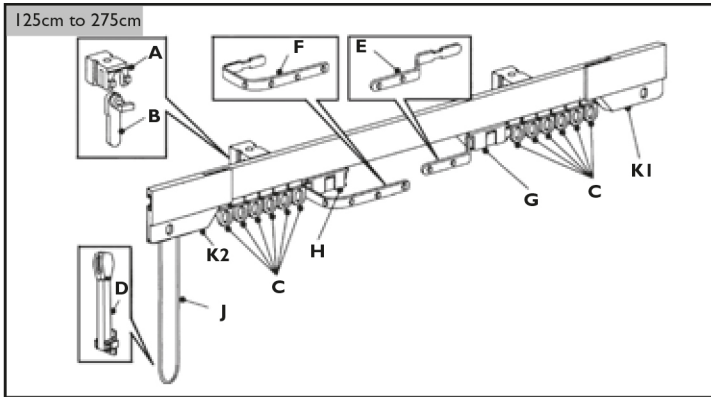

Track (cm)		125	150	175	200	225	250	275	300	350	400	500
Brackets & Levers	A&B	4	4	5	6	6	7	7	8	9	11	13
Gliders	C	16	18	22	26	28	32	34	38	44	50	62
Tension Cord Pulley	D	1	1	1	1	1	1	1	2	2	2	2
Underlap Arm	E	1	1	1	1	1	1	1	1	1	1	1
Overlap Arm	F	1	1	1	1	1	1	1	1	1	1	1
Pair of Master Carriers	G&H	1	1	1	1	1	1	1	1	1	1	1
Pull Cord	J	1	1	1	1	1	1	1	2	2	2	2
Pair of Pulley Housing	K1&K2	1	1	1	1	1	1	1	1	1	1	1
Centre Return Pulley	M	-	-	-	-	-	-	-	1	1	1	1
Centre Joiner	N	-	-	-	-	-	-	-	1	1	1	1

INFORMATION FOR BAY WINDOWS

PLEASE NOTE THAT SUPERLUXE TRACK IS ONLY SUITABLE FOR INTERNAL BENDS WITH A RADIUS OF 25cm OR MORE. WITH THE FRONT OF THE TRACK FACING YOU, BEND THE ENDS TOWARDS YOURSELF.

WARNING

It is essential that these instructions are followed to ensure the product works correctly and to prevent the risk of young children becoming entangled in the cord loop. If in doubt consult a professional fitter for advice.

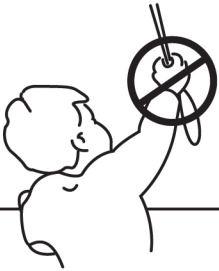

WARNING
Young children have been strangled by loops in pull cords, chains, tapes and inner cords that operate the product.
To avoid strangulation and entanglement, keep cords out of the reach of young children. Cords may become wrapped around a child's neck.
Move beds, cots and furniture away from window covering cords.
Do not tie cords together.
Make sure cords do not twist and create a loop.

PERSONS IN CHARGE OF CHILDREN ARE ULTIMATELY RESPONSIBLE FOR FOLLOWING THE SAFETY INSTRUCTIONS PROVIDED BY THE MANUFACTURER AND TO USE ANY SAFETY DEVICE SUPPLIED.
The installation can be completed by non-professionals.

1. TOOLS REQUIRED

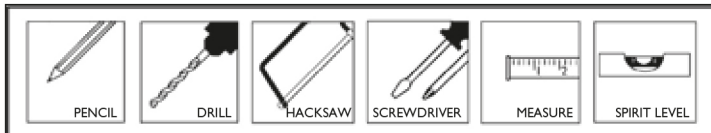

A general fitting pack is included but when fixing to dry line, masonry or studed walls ensure the correct fixings are used. If you are unsure please seek advice.

2. BRACKET SPACING

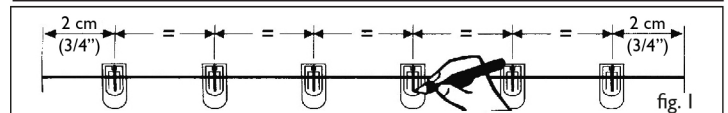

STRAIGHT RUNS - 125cm to 275cm

Decide where the track is to be fixed. Measure and mark the bracket positions using a spirit level and tape measure. NOTE: the end bracket should be positioned 2cm (3/4") from the end of the finished length of your track. Mark equally spaced positions for all remaining brackets (fig. 1). **The rail must be fitted at least 1.5m from the floor.**

STRAIGHT RUNS - 300cm to 500cm

Follow steps above but ensure bracket positions are marked 4cm either side of the centre. This allows for the track joiner and return pulley to be positioned correctly and gives maximum support when brackets are locked into position, as shown in fig. 2.

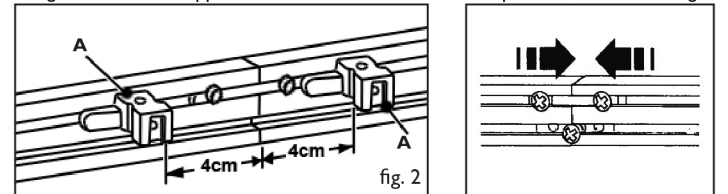

BAY RUNS

(Ensure all remaining brackets are equally spaced between those shown with specific distances from corners). Additional fixing brackets are sold separately if required from your local Swish stockist - part number WD310W0005K.

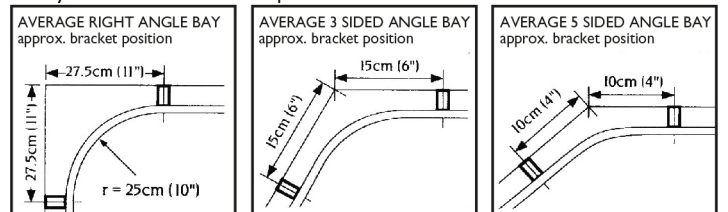

3. BRACKET FIXING

Secure all brackets A into position. Now install lever B into every bracket and leave in a vertical position.

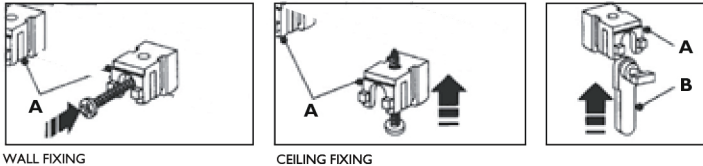

4. SHORTENING THE TRACK

125cm to 275cm - Cut from one end only

Using your finished track length calculated in section 2, mark a line equal to this length onto the track.

Subtract a further 4.5cm from this and draw a line. This is now your CUT line. This takes into account pulley housing (K2) when the rail is reassembled after cutting.

Pull outer cord (J) to move master carriers (G & H) to the centre of the track (closed position).

Slacken screw (X) and slide off pulley housing (K2). Move cords away from section of track to be cut off taking care not to twist the cords.

Carefully cut square using a hacksaw and smooth off cut edges.

Replace pulley housing (K2) taking care not to twist the cords and tighten screw (X) to secure.

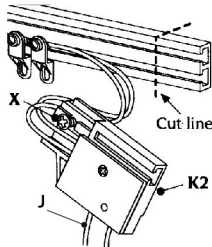

TO RECENTRALISE THE MASTER CARRIERS - (G & H)

Pull outer cord (J) until looped carrier (H) is tight against gliders (C).

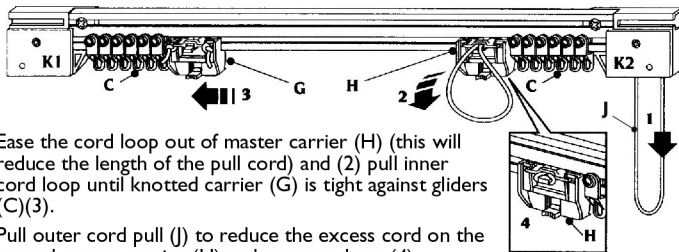

Ease the cord loop out of master carrier (H) (this will reduce the length of the pull cord) and (2) pull inner cord loop until knotted carrier (G) is tight against gliders (C)(3).

Pull outer cord pull (J) to reduce the excess cord on the looped master carrier (H) and resecure loop (4).

NOTE: If knotted master carrier (G) reaches gliders first, pull out loop from looped master carrier (H) and move carrier (H) by hand until it reaches gliders. Pull outer cord (J) to reduce excess loop on looped master carrier (H) and resecure.

300cm to 500cm - Cut from each end

Using your finished track length calculated in section 2, divide this distance by 2 and subtract a further 4.5cm.

Measuring from the centre, mark a line on each section of track equal to this newly calculated length. This is now your CUT line and takes into account pulley housings (K1 & K2) when the rail is reassembled after cutting.

Carriers (G & H) are operated individually by using pull cords (J) at each end.

Pull outer cord (J) to move master carriers (G & H) to the centre of the track (closed position).

Slacken screw (X) and slide off pulley housing (K1 & K2). Move cords away from section of track to be cut off taking care not to twist the cords.

Carefully cut square using a hacksaw and smooth off cut edges.

Replace pulley housings (K1 & K2) taking care not to twist the cords and tighten screw (X) to secure.

NOTE: If your cord pull requires shortening, see section 8.

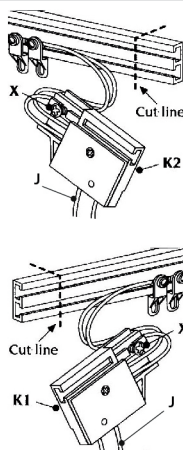

5. CONVERT PULL CORD TO OPPOSITE END

125cm to 275cm ONLY

Pull cord to bring the two master carriers (G & H) to the centre of the track.

Pull the outer cord on the looped carrier (H) so that the cord loop at the end disappears into the pulley housing (K2).

Release screw (X) and remove rear cover from opposite pulley housing (K1).

Pull the outer cord so the loop in master carrier (H) is pulled through the pulley housing (K1). Secure loop to carrier as shown.

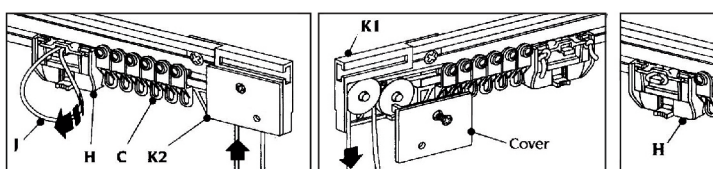

6. CONVERTING TO ONE WAY DRAW

125cm to 275cm ONLY

Detach cord loop from master carrier (H).

Pull outer cord so that cord loop at the end is pulled into the track.

Loosen screw (X) and remove pulley housing (K2).

Remove gliders (C) and master carrier (H).

Add or remove gliders (C) behind the remaining master carrier as required to achieve one way draw direction.

Replace pulley housing (K2), ensuring cords are not twisted and tighten screw (X) to secure.

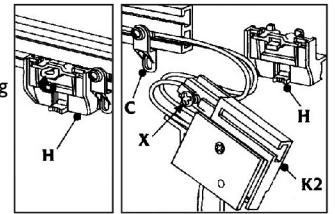

7. ASSEMBLY & INSTALLATION

125cm to 275cm ONLY

Starting at one end offer the upper channel of track up to fixing bracket (A) and secure by rotating Lever (B) through 90° to a horizontal position.

300cm to 500cm ONLY

Lay track face down onto a flat surface. Slide centre joiner (N) halfway into track ends and tighten screws. Repeat for centre return pulley (M).

Starting at the centre offer the upper channel of track up to fixing bracket (A) and secure by rotating Lever (B) through 90° to a horizontal position.

When installing longer lengths, assistance may be required to support the rail at the other end.

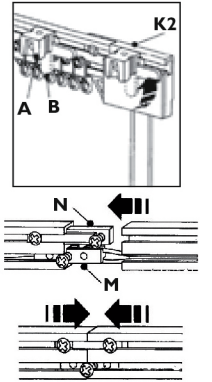

ALL SIZES (125 - 500cm)

Overlap arm (F) and Underlap arm (E) can be easily located into either carrier (G & H). These can be easily altered depending on the light direction.

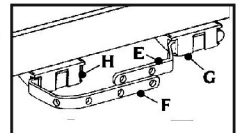

8. FITTING THE TENSION CORD PULLEY

Pull outer cord to curtains open position.

Take inner most cord (J) from master carrier (G) and pull until the required amount of pull cord is left hanging from pulley housings.

To prevent the risk of child strangulation the cord loop must be 1m maximum from the rail and the tension pulley must be fitted.

NOTE: It is the responsibility of the person fitting the rail to ensure that the cord length meets the stated requirements.

Extend the neck of the pulley and secure in higher position using a pin or small nail. Remove the central barrel of the pulley by pulling it down and then out. Place the cord inside the pulley and replace the barrel ensuring it clicks into place. (fig.1)

Take up the slack of the cord and tie a knot behind the masterside arm. If there is insufficient tension in the cord, reduce the cord length by adjusting the knot behind the masterside arm. (fig.2)

Twist the pulley back, the cord will now be fully tensioned. (fig.3)

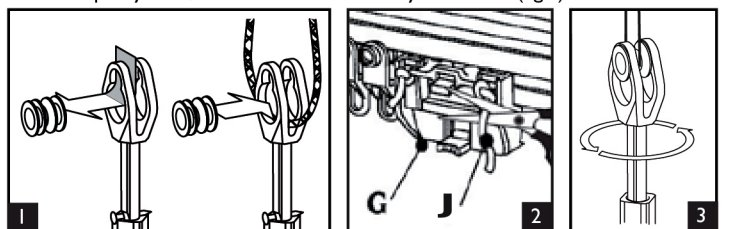

9. HANGING YOUR CURTAINS

Insert Swish WN800 curtain hooks into curtain tape.

Allow one hook for each pulley housing and two for each master carrier i.e. total hooks required = no. of gliders +6.

Lift curtain up to track and support curtain weight while attaching first two header tape hooks to the master carrier and, working outwards, hooking header tape hooks into gliders. Attach final hook to the pulley housing. Repeat for opposite side.

