

SOLOGLYDE & ALUGLYDE CURTAIN TRACK

Fitting Instructions

Please keep for future reference

Tools required

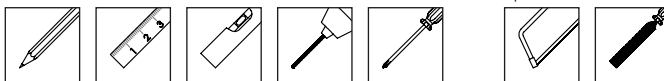

Please read these instructions carefully and check the contents of the pack before attempting to assemble and fit this product.

Pack Contents

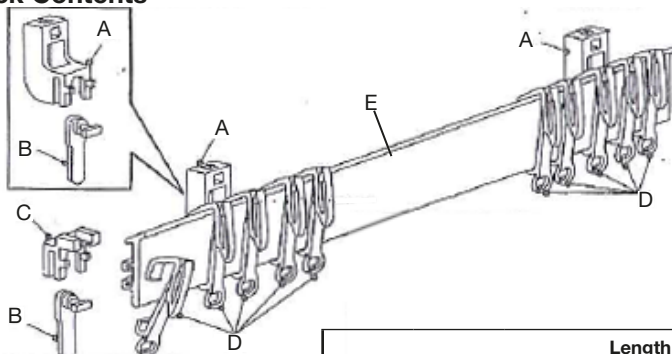

		Length						
Parts		125cm	150cm	175cm	200cm	225cm	250cm	275cm
A	Brackets	4	5	6	6	7	8	8
B	Levers	6	7	8	8	9	10	10
C	End Stops	2	2	2	2	2	2	2
D	Glidern	16	18	22	26	28	32	34
E	Track	1	1	1	1	1	1	1

Should any component be missing, please call the Customer Care Department on **0330 005 2233**.

Safety Recommendation

Always use a Step Ladder when working at heights.

DO NOT over reach. Always move the Step Ladder so that you are in a safe working position.

DO NOT hold or lean on the track to support your weight.

We recommend you use two people for installation of larger track.

Take care when using power tools, use of a Residual Current Device (RCD) is recommended.

Always use eye protection when drilling. Beware of hidden pipe runs and cables.

No liability will be accepted for damage or injury caused by incorrectly installed or assembled product.

PLEASE KEEP OUT OF THE REACH OF YOUNG CHILDREN. SMALL PARTS - CHOKING HAZARD
PLEASE KEEP THESE INSTRUCTIONS AND THE BATCH CODE ON THE PACKAGING FOR FUTURE
REFERENCE IN CASE OF ANY QUERIES

Installing the Brackets

Wall fixing

1. Mark a line on the wall, 10cm over the top edge of the window. (Fig.1)
2. Centre the track to the window and mark the position for the end brackets no more than 7cm from the end of the track. (Fig.1) Ensure that the track overhang is long enough to dress the curtains. The track can be cut to size if required.
3. Mark the position of the remaining brackets by distributing them evenly along the track.
4. Drill holes and fit the correct plugs if fixing on masonry wall, If you are unsure please consult your local builders merchant or DIY store. Fix all the brackets using the correct screws. (Fig.2)

Note: If you are fitting in a bay follow Fig. 4 for the brackets position in the corners.

If you are using two tracks joined together, the brackets must be placed 4cm on either side of the join.

Ceiling fixing

1. Mark a line parallel to the wall where you wish to install the track. We recommend the track to be installed at least 10cm from the wall. (Fig.3)
2. Follow step 2 to 4 from the wall fixing section.

Cutting the rail

1. Measure and mark the required length of track.

Note: If you are joining two tracks, both tracks need to be the same length.

2. Using a hacksaw carefully cut to length ensuring a straight edge remains. (Fig.5)
3. Remove all burrs using a file.

Joining the tracks (if required)

1. Using a D312W centre joiner (sold separately) slide halfway into each end of the track. Ensuring the joiner is in the centre of the installation. (Fig.6)

Assembly

1. Assemble levers into end stops as shown (Fig.7)
2. Fit one end stop and position 2.5cm from the track end and lock into position by rotating the lever through 90° until horizontal. (Fig.8)
3. Fit the glider over the end stop. (Fig.8)
4. Add the remaining gliders from the other end.
5. Repeat step 2 and 3 at the other end of the track.

Installation

1. Starting at one end offer the rear channel of track to fixing brackets leaving 7cm overhang (Fig.1 & 3).
2. Fit the track to each bracket and lock the bracket by rotating the lever through 90° until horizontal. (Fig.8)
3. The track is now ready for curtains.

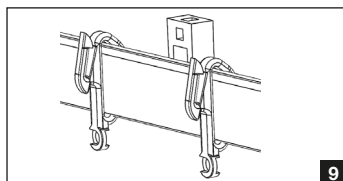
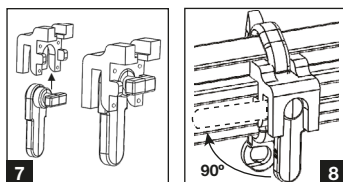
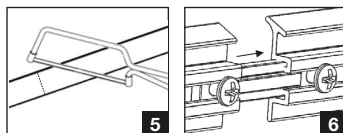
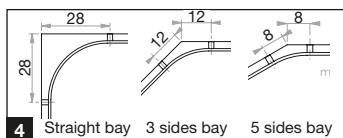
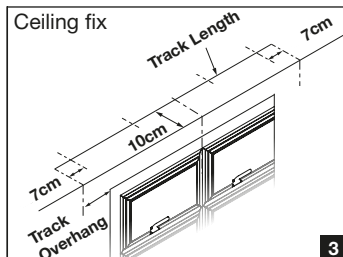
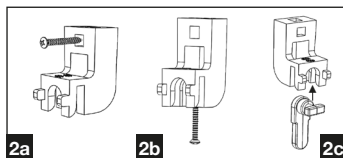
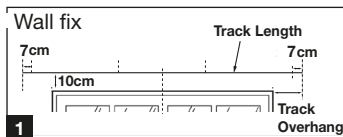

DO NOT PRINT THIS PAGE

DO NOT PRINT - REFERENCE ONLY

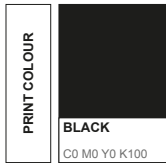

PRODUCT	Rev.
SOLOGLYDE/ALUGLYDE	3
APPROVAL (SIGN AND DATE)	

CUSTOMER	SWISH	FORMAT
L CODE	INST103--08	A5 DOUBLE SIDE PRINT
DIMENSIONS	A5 148X210MM	

DO NOT PRINT THIS PAGE