

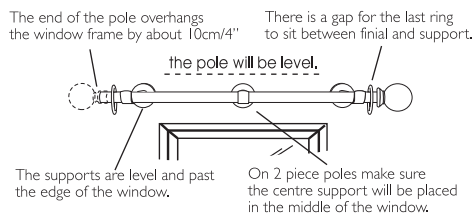



28mm Woodland Pole Fixing Instructions

Please read carefully before commencing





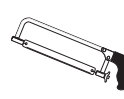
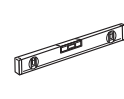
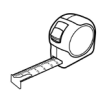



Tools Required







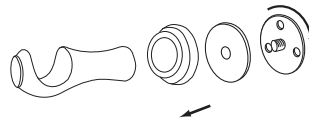

All measurements are approximate.

Please note: Additional wall screws/plugs maybe be required than those supplied in the pack. Please assess the wall type and condition you are fixing into. Wall boards & plasterboards require the use of anchors such as expansion/toggle bolts. Brick, tile or stone require special plugs & drill bits. Remember to always pre-drill holes into wood to avoid splitting.

Parts List						
						
	Pole	Pole Connector	Brackets	Finials	Rings	Screws & Wall Plugs
120cm	1 x 120cm	0	2	2	12	6 sets
150cm	1 x 150cm	0	2	2	16	6 sets
180cm	1 x 180cm	0	2	2	18	6 sets
240cm	2 x 120cm	1	3	2	24	9 sets
300cm	2 x 150cm	1	3	2	30	9 sets
360cm	2 x 180cm	1	3	2	36	9 sets

- 1** Remove the back plate and the foam insert from the brackets by turning the back plate until it detaches from the bracket.



- 2** Mark & drill the bracket fixing positions, making sure they are level.

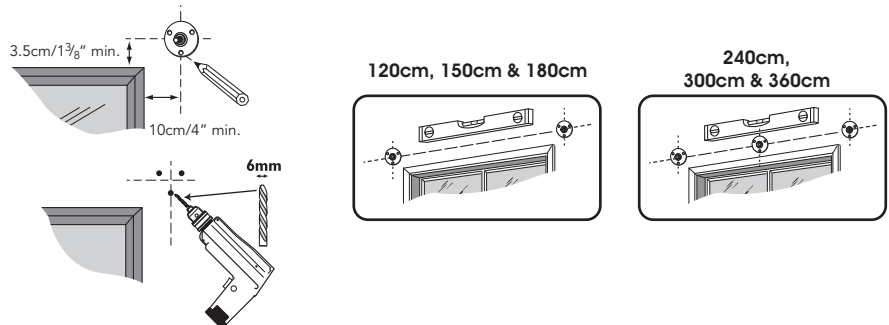

- 3** Fix the screws into the wall leaving a small section protruding from the wall.

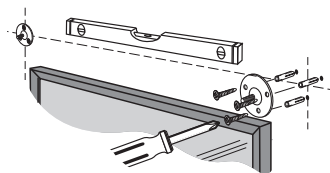

- 4 (A)** Attach the brackets and the foam insert onto the back plates. Line up the bracket with the screw on the back plate and turn the bracket until the bracket is secure.

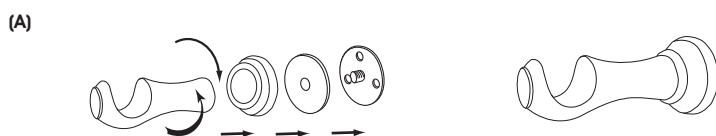

28mm Woodland Pole Fixing Instructions

Please read carefully before commencing

Trimming a single pole - 120cm, 150cm & 180cm

ONLY TRIM THE CURTAIN POLE IF IT IS NECESSARY.

- 5** (A) Measure & mark the length of pole you need to remove on one side of the pole. Using a hacksaw cut the pole and dispose of the excess pole piece.



Trimming double poles - 240cm, 300cm & 360cm

(B) Measure & mark the length of pole you need to remove. Using a hack saw trim an equal amount from each end of the pole, dispose of the excess pole piece. Place the factory cut ends at the centre where you pole join will be.

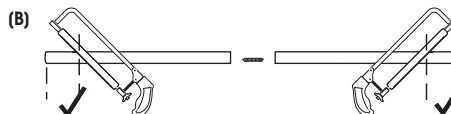

Fixing single poles - 120cm, 150cm & 180cm

- 6** Fixing the pole to the brackets.

(A) Slide the curtain rings onto the pole. Screw the finials into the end of the pole. Check they are secure. Hang the pole onto the brackets. Make sure the last ring at each end of the pole is placed after the bracket.

(B) Secure the pole to the brackets with the screw behind the bracket cup.

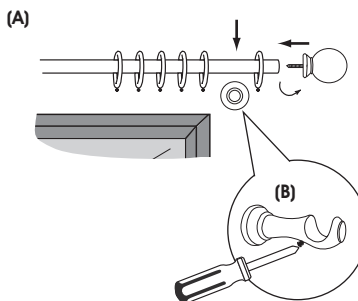

Fixing double poles - 240cm, 300cm & 360cm

- 7** Fixing the pole to the brackets.

(A) Screw the pole connector into the first pole half way and then screw the remaining part of the connector into the second pole until both poles are flush together. Both poles should now be attached together.

(B) Slide the curtain rings onto the pole. Screw the finials into the end of the pole. Check they are secure. Hang the pole onto the brackets. Make sure the centre bracket covers the centre join of the curtain pole & the last ring at each end of the pole is placed after the bracket.

(C) Secure the pole to the brackets with the screw behind the bracket cup.

