

# Owners Manual

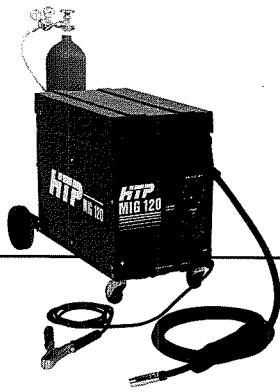

MIG 120

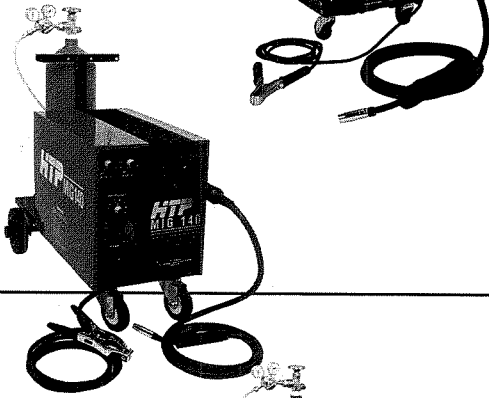

MIG 140

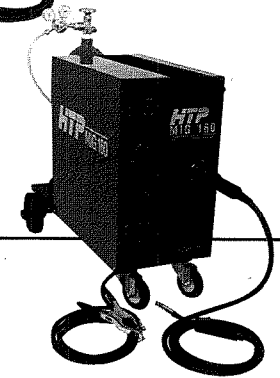

MIG 160

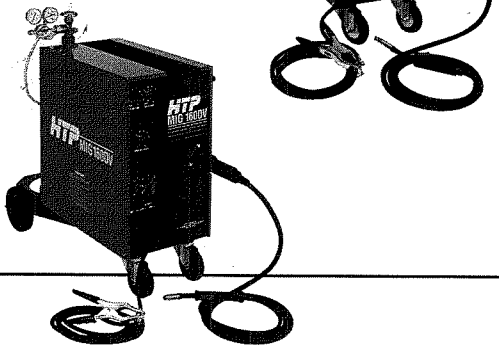

MIG 160DV



MIG 200

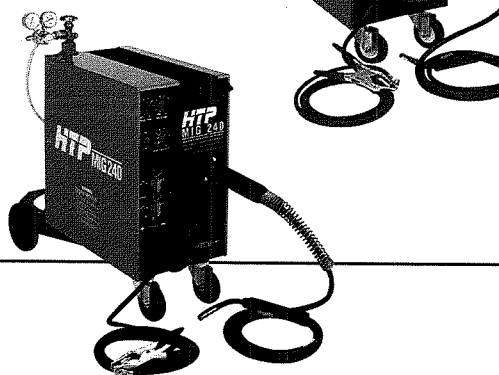

MIG 240

**HTP** America Inc.

180 Joey Dr., Elk Grove Village, IL 60007-1304  
847-357-0700 800-USA-WELD (800-872-9353)  
Fax: 847-357-0744 Email: [sales@htpweld.com](mailto:sales@htpweld.com)  
[www.usaweld.com](http://www.usaweld.com)

## **MANUFACTURER'S WARRANTY**

It is expressly agreed that there are no warranties, expressed or implied, made by either the Salesman, Dealer, or HTP America, Inc. on products or parts furnished hereunder, except the Manufacturer's Warranty against defective materials or workmanship as follows:

HTP America, Inc. warrants each new welding machine to be free from defects in material and workmanship under normal use and service for three years after delivery to the original purchaser. HTP America, Inc. will repair and replace, at its factory, any part or parts thereof, products to be returned to HTP America, Inc. with transportation charges prepaid and which its examination shall disclose to its satisfaction to have been thus defective. This warranty being expressly in lieu of all other warranties, expressed or implied, and all other obligations or liabilities on its part and it neither assumes nor authorizes any other person to assume for it any other liability in connection with the sale of its machines.

This warranty shall not apply to any welding machine which has been repaired or altered by unauthorized service departments in any way so as in the judgment of HTP America, Inc. to affect its stability and reliability, nor which has been subjected to misuse, negligence or accident.

HTP America, Inc. shall not be liable in any event, unless HTP America, Inc. receives notice of alleged breach of warranty within 30 days after the discovery, actual or construction alleged breach of warranty specifying the claimed defect.

HTP America, Inc. has reserved the right to make changes in design or add any improvements to its products at any time without incurring any obligation to install same on equipment.

This warranty is void unless warranty card is sent to HTP America, Inc. within 15 days from date of purchase.

### **NOTE: Exclusions To Warranty:**

1. The welding gun is warranted for a period of ninety (90) days against defects in material and workmanship.
2. The swan neck, nozzle spring, contact tips, gas nozzles, and liners are consumable items, WHICH CARRY NO WARRANTY.

**NOTE: This warranty is to to original purchaser only. The warranty can be transferred to another owner, with HTP's approval, for a warranty transfer fee. HTP America, Inc. must be notified within fourteen (14) days of the sale and must be provided with the contact information of the original owner, the contact information of the new owner, and the serial number of the machine.**

# INDEX

Introduction .....	2
Safety Suggestions .....	2
Electrical Connection .....	3
Front Panel Controls (except MIG 120) .....	4
Front Panel Controls (MIG 120) .....	6
Feeding the Welding Wire .....	7
Adjusting the Welding Machine .....	8
Seam Welding .....	9
Stitch Welding .....	10
Metal Shrinking .....	10
Spot Welding .....	11
Hole Filling .....	11
Welding Aluminum .....	12
Stud Welding .....	13
Welding Muffler Pipe .....	13
Broken Stud Removal .....	14
Welding Cast Iron .....	14
Maintenance and Service .....	14
Changing the Contact Tip .....	15
Changing the Gas Nozzle .....	16
Setting the Pressure on the Pressure Roller .....	16
Changing the Drive Roll .....	17
Replacing the Printed Circuit Board .....	17
Testing and Changing the Liner .....	18
Changing the Swan Neck .....	19
Monthly Maintenance .....	19
Shield Gas .....	20
Welding Wire .....	20
MB-13AK Welding Gun Parts List .....	21
MB-15AK Welding Gun Parts List .....	22
Mini MIG Welding Gun Parts List .....	23
#1 Style Welding Gun Parts List .....	24
Internal Components – MIG 120 .....	25
Internal Components – MIG 140 .....	26
Internal Components – MIG 160 .....	27
Internal Components – MIG 160DV .....	28
Internal Components – MIG 200 .....	29
Internal Components – MIG 240 .....	30
Schematic – MIG 120 .....	31
Schematic – MIG 140 .....	32
Schematic – MIG 160 .....	33
Schematic – MIG 160DV .....	34
Schematic – MIG 200 .....	35
Schematic – MIG 240 .....	36
PCB Wiring Diagram .....	37
Amperage Charts	
MIG 120 .....	38
MIG 140 .....	38
MIG 160 .....	38
MIG 160DV .....	39
MIG 200 .....	39
MIG 240 .....	40
Wire Drive System Parts List .....	41

## INTRODUCTION

We congratulate you on the purchase of your new HTP Series III MIG Welder. Your HTP MIG Welder will allow you to weld items you wouldn't have thought possible to weld. Your HTP MIG Welder can weld steel, stainless steel, aluminum, cast iron, HSLA steels and even braze steel. With proper care and maintenance, your new HTP MIG Welder will deliver years of trouble-free service. However, it is very important that you read the following manual completely.

## Safety Suggestions

ELECTRIC ARC WELDING PRODUCES ULTRA-VIOLET RAYS WHICH ARE HARMFUL TO SKIN AND EYES. ULTRA-VIOLET RADIATION CAN PENETRATE LIGHTWEIGHT CLOTHING, REFLECT FROM LIGHT-COLORED SURFACES, AND BURN THE SKIN AND EYES. WEAR FLAMEPROOF WELDING GLOVES WHICH ARE NOT OILY OR GREASY. THE OIL OR GREASE ON THE GLOVES MAY IGNITE.

Wear a heavy, pocketless, long sleeve shirt, cuffless trousers, and high-topped work shoes. Wear a full-face welding helmet with a number eight or darker lens and a cap. These precautions will protect eyes, hair, face, and skin from arc rays and hot material.

To avoid fire, do not weld on wood, plastic tile, or carpeted floors. Concrete or masonry floors are safest.

Do not weld on drums, barrels, tanks or other containers until they have been cleared as described in AWS Standard A6.01.

Provide adequate ventilation in the welding area at all times. Do not weld on galvanized zinc, cadmium or lead beryllium materials unless you are POSITIVE that sufficient ventilation is provided. These materials produce toxic fumes.

Do not weld in areas close to degreasing or spraying operations. Chlorinated hydrocarbon vapors may react with the ultra-violet rays and form highly toxic phosgene gas.

If you develop momentary eye, nose or throat irritation during welding, stop welding immediately. This is an indication that ventilation is not adequate. Do not continue to weld until ventilation is improved.

Exposed, electrically hot conductors or other bare metal in the welding circuit, or ungrounded electrically hot equipment can fatally shock a person whose body becomes a conductor. Do not stand, sit, lie, lean on or touch a wet surface when welding.

Frequently inspect cables for wear, cracks, and damage. Replace those with excessively worn insulation to avoid a possible lethal shock from bared cable.

For more information, refer to the following standards and comply as applicable.

1. ANSI Standard Z49.1 SAFETY IN WELDING AND CUTTING, obtainable from the American Welding Society, 2051 NW 7th St., Miami, FL 33125.
2. ANSI Standard Z87.1 SAFE PRACTICE FOR OCCUPATION AND EDUCATIONAL EYE AND FACE PROTECTION, obtainable from American National Standards Institute, 1430 Broadway, New York, NY 10018.
3. America Welding Society Standard A6.0 WELDING AND CUTTING CONTAINERS WHICH HAVE HELD COMBUSTIBLES, obtainable same as item 1.
4. NFPA STANDARD 51. OXYGEN-FUEL GAS SYSTEMS FOR WELDING AND CUTTING, obtainable from the National Fire Protection Assoc., 470 Atlantic Avenue, Boston, MA 02210.
5. NFPA Standard 51B. CUTTING AND WELDING PROCESSES, obtainable same as item 4.
6. CGA PAMPHLET P-1. SAFE HANDLING OF COMPRESSED GASES IN CYLINDERS, obtainable from the Compressed Gas Association, 500 Fifth Avenue, New York, NY 10036.
7. OSHA Standard 29 CFR, Part 1910, Subpart Q WELDING, CUTTING AND BRAZING.

## ELECTRICAL CONNECTION

### MIG 240, MIG 200, AND MIG 160

Your HTP MIG 240, MIG 200 and MIG 160 will only operate when PROPERLY connected to a 220 volt, single phase power source wired for a minimum of 40 amps for the MIG 240, 30 amps for the MIG 200 and 25 for the MIG 160. All electrical connections should be done by a qualified electrician in accordance with the National Electrical Code and local codes and ordinances. When connecting your MIG 240, 200 or 160 Welder, the green or yellow-green wire MUST BE CONNECTED TO GROUND, OR SERIOUS INJURY MAY RESULT.

The welders have a line voltage adjustment on the main transformer similar to Fig. 1. The correct line voltage must be selected in order for your welder to operate properly.

To set your line voltage adjustment, be sure the welder is unplugged. Remove the left hand side panel as you are facing the front of the welder. Locate the line voltage adjustment. Measure your input line voltage with a voltmeter. If your voltage measures 225 volts or less, the metal tabs (a) should be set to the 208 v position as shown in Fig. 1. If your line voltage is 226 volts or higher, the metal tabs (a) should be moved to the 240 v position. In order to move the metal tabs, it is necessary to remove two 7mm nuts first.

*Note: Your welder has a circuit breaker installed at the rear of the machine, just above where the input power cord goes into the welding machine. If, after connecting the machine to a 220 volt power supply and turning the power switch on, the machine does not come on, be sure the circuit breaker is in the ON position.*

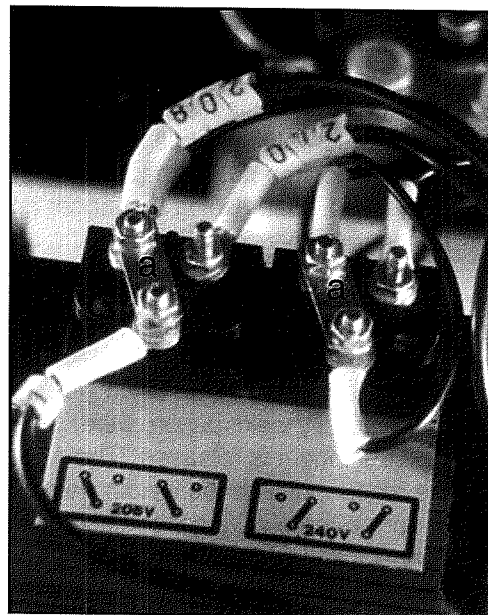

(Fig. 1)

### MIG 160DV

The MIG 160DV can be wired to operate on either 110 or 220 volt power. When operating the machine on 110 volts the 160DV should be connected to a 110 volt power source wired for a minimum of 30 amps. When operating the 160DV on 220 volts, the machine should be connected to a single phase 220 volt power source wired for a minimum of 30 amps. All electrical connections should be done by a qualified electrician in accordance with the National Electrical Code and local codes and ordinances. When connecting your MIG 240, 200 or 160 Welder, the green or yellow-green wire MUST BE CONNECTED TO GROUND, OR SERIOUS INJURY MAY RESULT.

To change voltages, locate the line voltage adjustment on the main transformer of the 160DV. (be sure the machine is unplugged and remove the left hand side panel) The line voltage adjustment is similar that found on the 160, pictured in figure 1, except it is much larger. Figure 1A shows a diagram of the voltage adjustment. The metal tabs are represented by black lines. For connection to 110 volts, the tabs in positions 1, 2, 3, and 5 would all be wired to the left, with no tab in position 4. To be wired for 240 volts, the tabs in positions 1, 2, 4 and 5 would all be facing right, with no tab in position 3. Measure your input line voltage, and adjust your tabs to the closest voltage on the chart. Install the proper plug on the end of the power cord.

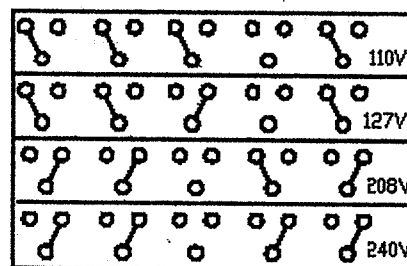

(Fig. 1a)

*Note: The MIG 160DV has a circuit breaker installed at the rear of the machine, just above where the input power cord goes into the welding machine. If after connecting the machine to your power supply and turning the power switch on, the machine does not come on, be sure the circuit breaker is in the ON position.*

### MIG 140 AND MIG 120

The HTP MIG 140 and MIG 120 have been designed to operate on 120 volt power. The MIG 140 requires a 30 amp service when operating at full power and the MIG 120 will draw 25 amps when operating at full power. All electrical connections should be done by a qualified electrician in accordance with the National Electrical Code and local codes and ordinances. When connecting your MIG 140 or MIG 120, the green or yellow-green wire MUST BE CONNECTED TO GROUND, OR SERIOUS INJURY MAY RESULT.

*Note: The MIG 140 has a circuit breaker installed at the rear of the welder, just above where the input power cord goes into the welding machine. If after connecting the machine to a 120 volt power supply and turning the power switch on, the machine does not come on, be sure the circuit breaker is in the ON position.*

## FRONT PANEL CONTROLS

(Except MIG 120 see fig. 2)

1. **Pause Time** — When the pause time knob is switched ON to any numerical setting, without switching ON the weld time knob, the welding machine is in the continuous welding mode. The continuous welding mode is selected when welding long seams and it is desired not to keep the trigger on the welding gun depressed. Depressing the trigger and releasing it will activate the welding machine. The welding machine will continue welding until the trigger is depressed and released again.

When both the pause time knob and the weld time knob are switched ON the machine is in the stitch welding mode.

With the machine in the stitch welding mode, the machine will automatically weld, pause, weld, pause and continue in this cycle until the trigger is released. The pause time knob determines the amount of time the welder pauses. Position 1 is a pause of approximately 1/2 second and position 9 is a pause of approximately 5 seconds.

While the welder is pausing, the shielding gas still flows out to assist in cooling the weld to help prevent warpage. The weld time knob determines the amount of time the machine will weld.

When both the pause time knob and weld time knob are in the OFF position, the machine is in the seam welding mode. This is the most common welding mode. When you depress the trigger, the machine will weld, when you release the trigger, the machine stops.

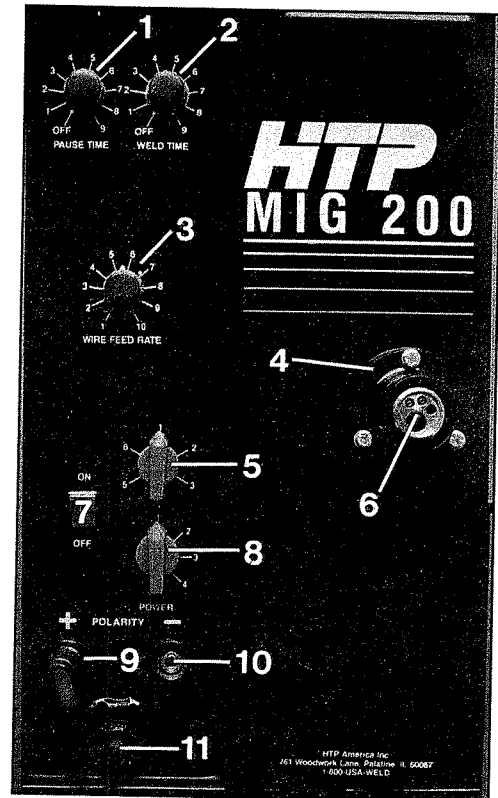

(Fig. 2)

2. **Weld Time** — When the weld time knob is switched ON, without switching ON the pause time knob, the welding machine is in the spot welding mode. In the spot weld mode, the welder will weld for a predetermined time period and stop. The welder will not weld again until the trigger is released and depressed. The spot weld time is determined by the weld time knob. Position 1 is a weld time of approximately 1/2 second, while position 9 is a weld time of approximately 2 1/2 seconds.

When both the weld time knob and the pause time knob are switched ON the machine is in the stitch welding mode. With the machine in the stitch welding mode, the machine will automatically weld, pause, weld, pause and continue in this cycle until the trigger is released. The weld time knob determines the amount of time the welder welds. Position 1 is a weld time of approximately 1/2 second and position 9 is a weld time of approximately 2 1/2 seconds.

3. **Wire Feed Rate** — The wire feed rate is infinitely adjustable and controls the wire speed. Minimum is the slowest and maximum is the fastest. The wire feed rate will depend on the wire diameter and the power switch position. The wire speed setting is tuned into the proper welding sound. A hissing, blowing sound with a ball of molten wire forming at the end of the wire and then dropping off indicates the wire feed rate is too slow. A loud cracking noise with the wire pushing the nozzle away from the work indicates the wire feed is too fast. The proper wire feed rate is obtained when a steady buzzing noise is heard while welding.
4. **Adapter Flange** — The adapter flange houses the adapter block and is bolted to the front panel of the welder.
5. **Power** — This switch controls the welding current. Position 1 has been designed for very thin panels (26 gauge and thinner) and metal fill. Position 2 and 3 are for slightly heavier panels or rusty pipe (24 to 22 gauge). Positions 4 and 5 are for heavier sheet metal and new muffler pipe (20 to 16 gauge). Positions 6 on the MIG 140, 5 and 6 on the MIG 200, and 6, 7, and 8 on the MIG 160 are for spot welding, frame repair, general repair welding, and thicker materials. The MIG 240 has 4 power settings.

**WARNING: DO NOT CHANGE SWITCH POSITION WHILE WELDING. THIS WILL CAUSE THE CONTACTS TO ARC DAMAGING THE SWITCH.**

- 6. Adapter Block** — This is where the welding gun connects to the machine. This single connection houses the power, welding wire, shield gas, and trigger wires.

To install the welding gun, simply insert the male central adapter block (on welding gun) into the female central adapter block (on welding machine). These will only fit together in one way. Tighten the adapter nut securely by hand.

- 7. On-Off Switch** — This switch controls the input power to your welder. The On-Off Switch allows you to turn the welding machine off, leaving all the settings intact, ready for your next use.

Turning the switch to the on position will illuminate an indicator lamp in the On-Off switch and activate the cooling fan. If the indicator lamp is not lit when the On-Off switch is in the ON position, check to make sure that the machine is properly connected to an electrical outlet in good working order. Also be sure to check the circuit breaker at the rear of the welder is in the ON position.

- 8. Fine Power Switch (MIG 200 ONLY)** — The Fine Power switch on the MIG 200 welder has 4 positions. 1 is low, 2 is medium, 3 is high, and 4 is extra high. This means that the welder has 4 different heat settings inside of each heat setting on the power switch (#5) for a total of 24 heat settings. For example if the power switch is set to 4, then the lowest heat setting for heat 4 would be to set the Fine Power switch to 1. Let's call this setting 4,1. The next setting would be to set the fine power switch to position 2, or 4,2. Then it would be 4,3 and then 4,4. If you still want a higher power setting, you would increase your power switch to 5, and then turn the fine power switch down to position 1, for a setting of 5,1.

**Fine Power Switch (MIG 240 ONLY)** — The Fine Power switch on the MIG 240 has 6 positions. 1 is lowest while 6 is the highest. This means the 240 has 6 different heat settings inside of each of the 4 heat settings on the power switch (#5) for a total of 24 heat settings. For example if the power switch is set to 2, then the lowest heat setting for heat 2 would be to set the Fine Power switch to 1. Let's call this setting 2,1. The next setting would be to set the fine power switch to position 2, or 2,2. Then it would be 2,3, 2,4, 2,5, and finally 2,6. If you still want a higher power setting, you would increase your power switch to 3, and then turn the fine power switch down to position 1, for a setting of 3,1.

- 9/10. Power Output Receptacles** — 9 is the positive power output receptacle and 10 is the negative power output receptacle. These control the polarity of the machine. For most welding applications, the ground cable will be connected to the negative receptacle (#10) and the welding gun lead (#11) will be connected to the positive receptacle (#9).

When using flux cored wire the polarity should be reversed. The ground cable would then be connected to the positive receptacle and welding gun lead would be connected to the negative receptacle.

If you are having burn-through problems when welding on extremely thin material with solid wire and shielding gas, you may want to reverse the polarity as this will reduce the penetration and make it easier for you to weld thin material.

When inserting the end of the ground cable into either power output receptacle, secure the ground cable by twisting it clockwise 1/2 turn. It is important that the ground clamp be connected to a good, clean, surface. Failure to do so will cause poor quality welds. Place the ground clamp as close as possible to the area to be welded.

- 11. Welding Gun Lead** — The welding gun lead takes the power from either power output receptacle and runs it to the welding gun. Secure it by twisting it clockwise 1/2 turn. For general welding, the welding gun lead will be connected to the positive power output receptacle.

## FRONT PANEL CONTROLS (MIG 120 see fig. 2a)

1. **Wire Feed Rate** — The wire feed rate is infinitely adjustable and controls the wire speed. Minimum is the slowest and maximum is the fastest.

The wire feed rate will depend on the wire diameter and the power switch position. The wire speed setting is tuned into the proper welding sound. A hissing, blowing sound with a ball of molten wire forming at the end of the wire and then dropping off indicates the wire feed rate is too slow. A loud cracking noise with the wire pushing the nozzle away from the work indicates the wire feed is too fast. The proper wire feed rate is obtained when a steady buzzing noise is heard while welding.

When the power setting (3) is increased, the wire feed rate will increase without adjusting the wire feed rate. Likewise, when the power setting (3) is decreased, the wire feed rate will decrease without adjusting the wire feed rate. Use the wire feed rate knob to fine tune the wire feed rate after you have changed the power setting.

2. **Thermo Switch Indicator Lamp** — When the Thermo Switch indicator lamp lights up, the duty cycle of your MIG 120 has been exceeded. Leave the machine plugged in and on, as the cooling fan will continue to run and cool your welder. When the light goes out, you can begin welding again.
3. **Power** — This switch controls the welding current. When the Power switch is in the "off" position, the machine is off. Position 1 has been designed for thin panels (24 to 22 gauge and thinner). Positions 2 and 3 are for slightly heavier panels or exhaust pipe (20 to 16 gauge). Position 4 is for 1/8" and thicker steel.

The "Gas Test" position will allow you test for gas flow. Simply pull the trigger while the switch is in the gas test position and the gas will start to flow.

**WARNING: DO NOT CHANGE SWITCH POSITION WHILE WELDING. THIS WILL CAUSE THE CONTACTS TO ARC DAMAGING THE SWITCH.**

- 4/6. **Power Output Receptacles** — 4 is the positive power output receptacle and 6 is the negative power output receptacle. These control the polarity of the machine. For most welding applications, the ground cable will be connected to the negative receptacle (#6) and the welding gun lead (#5) will be connected to the positive receptacle (#4).

When using flux cored wire the polarity should be reversed. The ground cable would then be connected to the positive receptacle and welding gun lead would be connected to the negative receptacle.

If you are having burn-through problems when welding on extremely thin material with solid wire and shielding gas, you may want to reverse the polarity as this will reduce the penetration and make it easier for you to weld thin material.

When inserting the end of the ground cable into either power output receptacle, secure the ground cable by twisting it clockwise 1/2 turn. It is important that the ground clamp be connected to a good, clean surface. Failure to do so will cause poor quality welds. Place the ground clamp as close as possible to the area to be welded.

5. **Welding Gun Lead** — The welding gun lead takes the power from either power output receptacle and runs it to the welding gun. Secure it by twisting it clockwise 1/2 turn. For general welding, the welding gun lead will be connected to the positive power output receptacle.

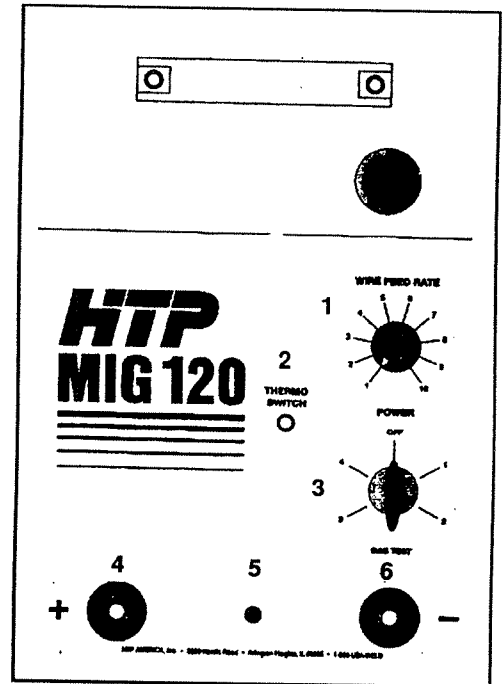

(Fig. 2a)



## FEEDING THE WELDING WIRE (See Fig. 3)

1. **(All models except MIG 120)** When using 10 lb. spools (this is the size which came with the essential kit), remove the red nut and install the spacer on the shaft. Do not use the spacer on 30lb. spools. On the MIG 140 model, place the wire on the shaft so it unravels from the top. On the MIG 160, 200 and 240 models, place the wire on the spool holder so it unravels from the bottom. Install the red nut. When using 10 lb spools, the pin in the shaft will not engage the roll of wire.

**(MIG 120)** The spool of wire is mounted horizontally. As you are facing the welder from the front of the machine, place the spool on the spindle so the wire unravels from the right hand side of the spool.

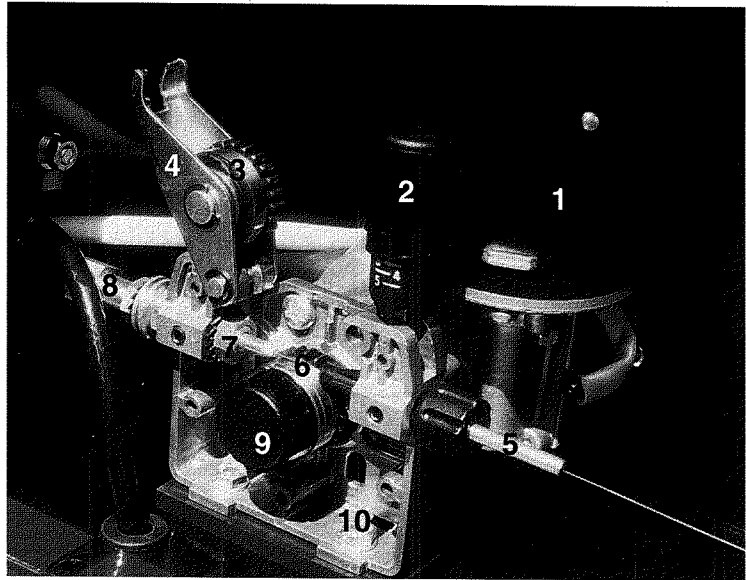

(Fig. 3)

2. Loosen the wire from the spool. Be extremely careful not to let the end of the wire go. Cut off the bent end of the wire to expose a piece of straight wire.
3. Swing the pressure release handle (2) to the side, and lift the pressure roller assembly (4) up and out of the way.
4. Feed the wire into the inlet wire guide (5), across the drive roll (6), and into the guide tube (7) or liner in the case of the MIG 120. (At this time it is a good idea to check that the drive roll is set to the correct groove for the wire size you are using. If not, see Changing the Drive Roll.) Continue to feed the wire into the guide tube until two or three inches of straight wire protrudes from the front of the central adapter block, or in the case of the MIG 120, until two or three inches of straight wire has been fed into the welding gun.
5. Swing the pressure roller assembly (4) back into position. Make sure that the wire is positioned in the groove of the drive roll (6). Unscrew the pressure release handle (2) until most of the pressure on the pressure roller has been released.
6. Remove the contact tip and gas nozzle from the welding gun. Turn the wire feed rate to 6. Depress the trigger on the welding gun. At this point, the wire feed should not be consistent because there is not enough pressure on the pressure roller. Slowly tighten the pressure roller adjusting screw until the wire feeds evenly without slipping. Then tighten an additional 1/4 turn for steel. No additional tightening is necessary for aluminum. **DO NOT OVERTIGHTEN!**

Continue feeding the wire until it appears at the tip of the welding gun. Check your wire size and install the correct contact tip. Install the gas nozzle.

7. Next, on all models except the MIG 120, the tension on the wire drive brake must be set correctly. The wire drive brake keeps the spool of wire from continuing to rotate after we have stopped welding. In the center of the shaft which the wire mounts is a bolt. This bolt puts tension on a spring, which in turn puts tension the shaft, acting as a brake for the spool of wire. Set the wire feed rate to maximum, and using a 1/2" socket, adjust the tension on the wire drive brake so the spool will continue to rotate 1/8 to 1/4 turn after you have released the trigger.
8. Bend the welding wire 90 degrees and hold the welding gun perpendicular to a non-conductive surface (concrete floor) so the wire will not feed. While looking at the wire feed mechanism, momentarily depress the trigger. The drive roll should slip and act as a clutching mechanism. If not, the drive roll will push the wire out between the roller and the guide tube. This is known as "bird nesting." If bird nesting occurs, the pressure roller has been adjusted too tightly. When properly adjusted, the drive roll will slip, and "bird nesting" will never occur.

## ADJUSTING THE WELDING MACHINE

In order to operate properly, the welding machine must be adjusted properly. Your HTP MIG Welder is very simple to adjust, and with a few minutes of practice, adjusting the controls will become instinctive.

There are two control points which have to conform: the power setting and the wire feed rate. The power setting is determined by the thickness of the material which is being welded (See Chart 3) and the wire feed rate is then "tuned in" to the power setting. The correct setting of the power and the wire feed rate can be seen in an even and calm arc and heard as a steady frying noise.

When selecting your power setting, if the weld doesn't appear to be penetrating the metal, then turn up your power setting. If you are burning holes in what you are trying to weld, then it will be necessary to turn down your power setting. If you are on the lowest heat setting and still having problems with burn-through, then you may want to reverse the polarity of your welder. Use the following chart as a guide.

Power Setting	Thickness of Material
1	30 ga to 24 ga
2	26 ga to 22 ga
3	24 ga to 20 ga
4	22 ga to 18 ga
5	20 ga to 16 ga
6	1/8" to 3/16"
7	3/16" to 1/4"
8	1/4" to 1/2"

(Chart #3)

A hissing, blowing sound with a ball of molten wire forming at the end of the wire and then dropping off indicates the wire feed rate is too slow (See Fig. X). This means that the wire is melting before it reaches the metal. A loud, cracking noise with red hot wire coming out of the gun and the wire pushing the gun away from the work indicates the wire feed rate is too fast (See Fig. Y). This means that the wire is melting beyond the weld and is not melting properly. When "tuned in" properly, a steady frying noise can be heard (See Fig. Z). This means that the wire is melting properly, and is melting right at the surface of the weld.

When tuning in your welding machine, it is best to start with the wire feed rate too high. On the highest power setting, you may actually want to start with the wire feed rate set at maximum. Gradually decrease the wire feed rate until the steady frying noise is heard. A common problem many people have when trying to tune the wire feed rate is that they turn the knob too rapidly. Many people never turn the wire feed rate down low enough, and then start to increase it again. If the wire feed rate is slowly decreased, then eventually you will cross the point where the machine will be tuned in. It is a good idea to practice tuning in the welding machine. Power setting #3 is an ideal heat setting for this, as it has a nice, crisp sizzle. Once you have mastered tuning in the machine on power setting #3, practice tuning in the machine on different heat settings.

It is highly recommended that you practice with your welder at different power settings so that you will become familiar with your welder. This is important to do prior to welding on a vehicle so that you will know which heat setting to select for the job.



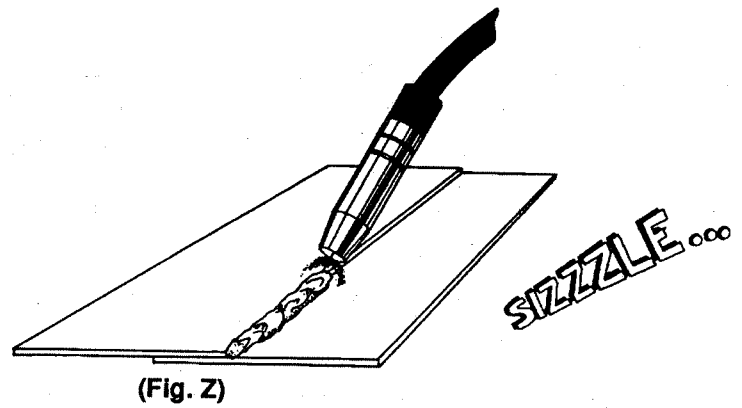
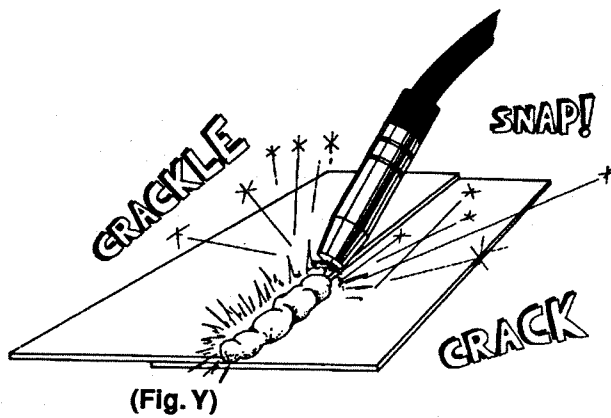

## SEAM WELDING

Install the conical nozzle (Part #15105 (13AK & 15AK Guns) Part # S4328 (Mini-MIG & #1 Guns)) on the welding gun. The conical nozzle is used because it is much easier to see the welding process due to the taper in the nozzle. Have 1/4" to 1/2" of welding wire protruding from the end of the gas nozzle.

Prior to running a seam weld, it is recommended that tack welds be placed every 2 to 3 inches along the seam, even closer for extremely thin panels. Tack welds will help to hold the panel in place while welding, as well as to prevent panel separation caused by warpage.

Hold the welding gun at a 45 degree angle and use the edge of the gas nozzle to hold the two panels together, aim the welding wire at the spot to be tacked. Momentarily press the trigger (approximately 1 second) and tack the two panels together. Do not lift up the welding gun until the weld has set. Tack welding is done at the same power setting at which seam welding is done. (1, 2, or 3 for sheet metal, 5, 6, or Max. for heavier metal.)

When you have the panel tacked into place, you are ready to seam weld. Once again, have 1/4" to 1/2" of welding wire protruding from the gas nozzle. The welding gun is generally held at a 45 degree angle to the work piece. It may also be tilted at a 45 degree angle to the side. Rest the gun nozzle on the work piece and have the wire pointing at the spot where the welding is to begin. Press the trigger and begin welding. It is important that you can see the welding wire coming out of the gas nozzle and the small halo formed at the end of the welding wire where it is melting. This halo will provide the light necessary to see through your helmet while welding.

The direction in which the welder travels will affect the characteristics of the weld. When "pushing the weld" the welding gun is tilted away from the direction of travel (see fig. 4). When "pulling the weld" the welding gun is tilted towards the direction of travel (see fig. 5).

"Pushing the weld" will produce a wider, flatter bead having slightly less penetration. "Pulling the weld" will produce a narrower, taller bead with slightly more penetration. When welding sheet metal, penetration is never a problem; therefore, use whichever technique feels the most comfortable. However, when welding thicker materials, it is recommended that you use the "pulling technique" to insure maximum penetration.

As you gain expertise with your welder, you will find that it is possible to reduce warpage when welding sheet metal by welding at a higher power setting and moving faster along the seam. In this way, you are reducing the amount of time welding, therefore reducing the amount of heat which is put into the panel.

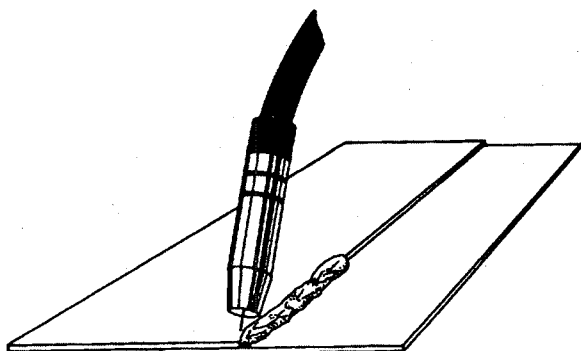

(Fig. 4) "Pushing the Weld"

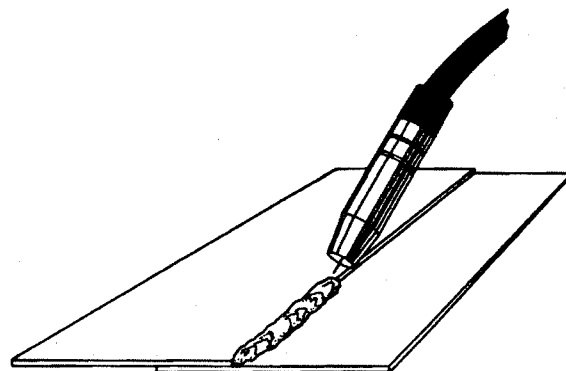

(Fig. 5) "Pulling the Weld"

## STITCH WELDING

Your HTP MIG Welder will perform both manual and automatic stitch welds. Stitch welding refers to a method of welding where the welding machine will weld, pause, weld, pause and continue in this cycle until deactivated. This method produces a welded seam which is actually a series of overlapping spot welds that give the appearance of "Fish Scales." Stitch Welding is recommended for use on very thin materials, such as thin body panels or rusty exhaust pipe and in areas where it is desired to keep warpage to a minimum. Stitch welding is also good for welders who have a problem keeping a steady hand, or maintaining a constant travel rate.

Stitch welding is performed with either the conical nozzle (Part #15105 (13AK & 15AK) #S4328 (Mini-MIG & #1 Gun)) or the cylindrical nozzle (Part #15104 (13AK & 15AK) #S4330 (Mini-MIG & #1 Gun)) and the decision is up to the operator. For manual stitch welding, the trigger on the welding gun is depressed until 1/8" diameter puddle of metal is deposited on the workpiece. Release the trigger and move the welding gun so that the center of the next puddle will lie on the edge of the first puddle. Wait for the orange glow from the first puddle to disappear and deposit the second puddle of metal. Continue this process until the seam is completed.

To perform automatic stitch welding, turn the pause time knob ON to approximately 2. Turn the weld time knob ON to approximately 3. Depress the trigger on the welding gun. The machine will automatically cycle between welding and pausing.

- If the welding time is too long, decrease the welding time slightly.
- If the welding time is too short, increase the welding time slightly.
- If the pause time is too long, decrease the pause time slightly.
- If the pause time is too short, increase the pause time slightly.

It has been our experience that the pause time should be adjusted so that the orange glow will just about disappear before the welding machine begins another weld cycle.

For a given thickness of metal, stitch welding is performed at the same or one power setting lower than seam welding. Stitch welding can be done on both steel and aluminum, and is recommended at or below power setting 4. Stitch welding at higher power settings can result in serious burnback problems.

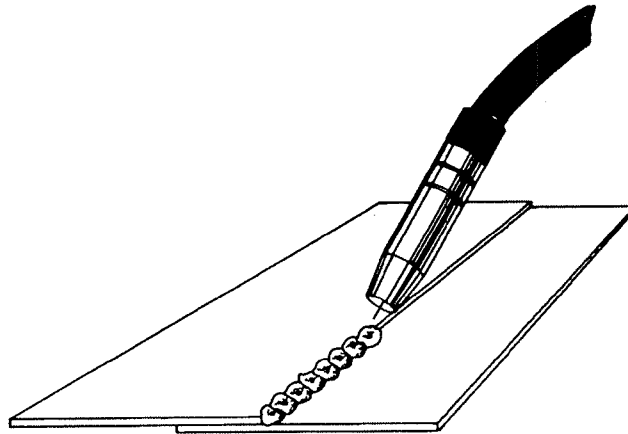

(Fig. 6) "Stitch Welding"

## METAL SHRINKING

Metal Shrinking is done with the optional shrinking attachment (Part #15003). Remove the contact tip. Release the pressure on the pressure roller and swing pressure roller out of the way. Reel enough welding wire back onto the spool so that the shrinking attachment can be screwed into the swan neck. Turn off the shield gas. You are now ready to shrink.

Shrinking with your shrinking attachment is similar with an oxy-acetylene torch; the area is alternately heated and cooled until properly shrunk. The advantage to the shrinking attachment is that the heat is applied directly, the heat is much more concentrated, and there is less chance of fire because there are no open flames.

**WARNING: SHRINKING SHOULD ONLY BE DONE WITH THE POWER SWITCH IN POSITION 1.**

## SPOT WELDING

Install the spot weld nozzle (Part #15106 (13AK & 15AK guns) Part #S4329 (Mini-MIG & #1 guns)) on the welding gun. Using the Punch & Flange Tool (Part #12005 {5/16"} or #12003 {3/16"}) or the Heavy Duty Hole Punch (#12009) punch holes in the upper panel to be spotted on. Feed some welding wire out past the end of the spot weld nozzle. Using sidecutters, clip the welding wire off flush with the end of the spot weld prongs. This will aid you in centering the gas nozzle over the punched hole.

Turn the power selector to position 5, 6, 7 or 8 (5 or 6 for thin sheet metal, 8 for heavier sheet metal). Tune in the wire feed rate until the proper frying noise is heard. Reduce the wire feed rate just until the machine begins to sound out of tune. A slightly slower wire feed rate will produce flatter spot welds, however, do not reduce the wire feed rate when performing overhead spot welds. Turn the spot weld timer on to approximately 2. Place the welding gun over the punched hole so that the welding wire is centered over the punched hole (see fig. 7). Depress the trigger on the welding gun. Your welder will stop automatically. Examine the spot weld. If the hole is not completely full, either the welding wire was not centered over the hole or there was not enough spot weld time. The spot weld time should be set to the minimum amount of time that will completely fill the hole. If the spot weld is not flat and has an excessive metal build-up, either there is an excessive amount of spot weld time, the wire feed rate is too fast, or the power is not high enough. The correct power setting, spot weld time, and wire feed rate will produce spot welds which will lie flat and require little, if any, finishing.

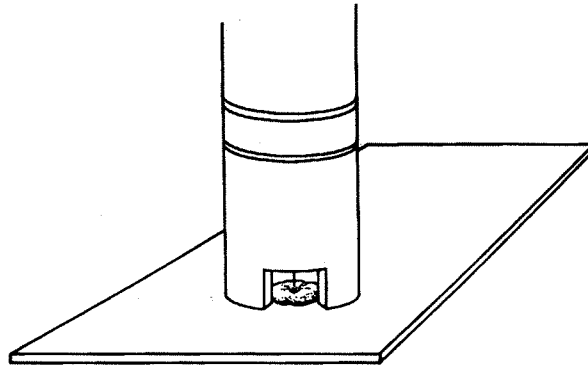

(Fig. 7) "Spot Welding"

## HOLE FILLING

Before you begin to fill holes, you must look at the reason why there are holes. If the holes are due to burn-through, you should remember that this was caused by too much heat input. Therefore, if you are welding a seam and burn-through occurs, continue welding and finish the seam. This will give the burn-through area time to cool and make it easier to fill the hole. It is not recommended to try to fill holes over 1/2" diameter; weld in a new piece of metal.

First, the perimeter of the hole must be built up. This is accomplished by randomly placing puddles of metal (similar to manual stitch welding) around the perimeter of the hole (See Fig. 8B). Once this has been completed, again place puddles around the area which has just been welded (See Fig. 8C). Continue to lay in the puddles until the hole is filled (See Fig. 8D & 8E). The power setting for hole filling is one to two settings below seam welding.

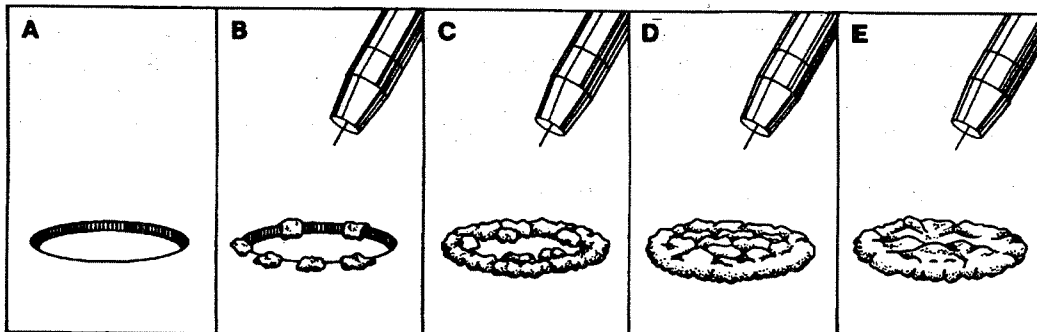

(Fig. 8) "Hole Filling"

## WELDING ALUMINUM

Due to the difference between aluminum and steel, a few simple changes must be made prior to welding aluminum.

**Shield Gas** — The shield gas required for welding aluminum is 100% Argon. Due to the rate at which aluminum oxidizes, the flow rate of the Argon gas must be increased to 30 to 50 cubic feet per hour (cfh). The cylindrical gas nozzle (Part #15004) is recommended for use when welding aluminum. The larger opening area of the nozzle will result in a wider dispersion of the shield gas, insuring adequate gas coverage of the weldment.

**Liner** — A teflon liner (Part #15044) is the preferred liner for welding aluminum. To change the liner, see "Testing and Changing the Liner."

**Welding Wire** — To weld aluminum, aluminum welding wire must be used. HTP has aluminum wire available in two diameters; Part #40230 — .030" diameter and Part #40235 — .035" diameter. The .030" wire is recommended for thin gauge to 1/8" material, while the .035" wire is recommended for .060" material and thicker. For installation of the aluminum wire, see "Feeding the Wire."

Whenever the welding wire has been changed, it is important that the correct size contact tip and drive roll groove have been selected. (See "Changing the Contact Tip" and "Changing the Drive Roll").

**Cleanliness** — Aluminum is very sensitive to impurities. Therefore, it is extremely important that the surfaces to be welded are clean from paint, grease and dirt. The only method that will properly clean aluminum is the use of a stainless steel wire brush (Part #40112 or #40110).

**Technique** — Aluminum also requires a slightly different technique when welding. The gas nozzle should be held perpendicular to the welding surface and inclined 5 to 15 degrees away from the direction of travel. The motion of the welding gun should be consistent and at a greater speed than used for welding steel. To minimize the chances of producing a black, sooty weld, you should always "Push the Weld."

Aluminum also has a very narrow heat range in which it can be welded. When you first start to weld, you will notice the weld has a tendency to sit up on top of the metal and not penetrate. If you keep welding you may see that it begins to penetrate fine and you get a great weld. As you continue welding, all of the sudden, you overheat the metal and blow a big hole. This is one of the problems of welding aluminum and just requires practice to overcome.

The end of the welding wire should always be clipped off with side cutters to aid in striking the arc.

The thermal conductivity of aluminum is much higher than that of steel. Therefore, when welding thin gauge aluminum a heat sink (HTP's Heat Sponge, Part #12080 or #12084) should be used. Aluminum hoods and trunk lids may require the stitch welding technique if burn-through is a problem.

Because of its better electrical conductivity, aluminum wire will require a higher wire feed rate for the same power setting.

The tendency for aluminum spatter to adhere to the swan neck, contact tip and gas nozzle is much greater than that for steel. Therefore, use of the nozzle spray is extremely important. However, the nozzle spray will act as a contaminant, so after treating the nozzle, it is important to test weld on a piece of scrap aluminum to "burn off" the nozzle spray.

When welding thick sections of aluminum (Cylinder Head), many times it is helpful to preheat the area with an oxy-acetylene welding torch. Using a rosebud tip, set the torch acetylene rich and blacken the area to be welded with a light coating of soot. Set the torch correctly, and begin to evenly heat the part. Let the heat within the part (not the torch) burn off the soot. When the soot has burned off, the part has not been sufficiently preheated.

**CAUTION** — Aluminum does not change color when hot.

## STUD WELDING

With the purchase of the optional DENT PULLER KIT (Part #12015-B (13AK & 15AK guns) Part # 12015-T (Mini-MIG & #1 Guns)), your HTP MIG Welder makes it possible to pull dents without drilling holes in the dented panel. The dent puller kit comes complete with one stud weld nozzle (Part #15007 or S4332), one box of 500 studs (Part #12038) and a special slide hammer.

Install the stud weld nozzle on the welding gun. Set the power to 5, 6 7 or 8 depending on the thickness of the material. Tune in the wire feed rate to the proper setting. Invert the welding gun and insert a stud in the tube protruding from the gas nozzle. The head of the stud will prevent the stud from falling out of the nozzle.

Grind away paint and rust from dented area to be pulled. Place welding gun against dented area so that the stud will be welded in the desired position. Place your finger over the end of the stud protruding from the nozzle so that the stud comes in contact with the dented panel. Depress the trigger on the welding gun while maintaining pressure on the stud. The stud will begin to melt. Continue welding until your finger has reached the gas nozzle and no more stud can be pushed into the panel. Allow the weld to cool. Remove gas nozzle from the stud.

Install the slide hammer on the stud. Pull the dent. After the dent has been pulled, remove the stud from the slide hammer.

The stud may be removed from the dented panel by grinding, clipping off with side cutters, or simply bending it from side to side until it snaps off.

## WELDING MUFFLER PIPE

Muffler pipe welding is generally done with the conical nozzle installed on the welding gun. The conical nozzle is used because the taper in the nozzle makes it easier to see the welding process and allows you to weld in tighter spots.

Prior to welding two pieces of muffler pipe together, it is recommended that two to three tack welds be placed around the pipe. The tack welds will help hold the pipe in place while welding, and also prevent gaps caused by warpage.

Have 1/4" to 1/2" of welding wire protruding from the end of the gas nozzle. Have the welding gun inclined at a 45 degree angle to the pipe. Aim the welding wire at the spot to be tacked and momentarily depress the trigger. Hold the trigger long enough for the welding sound to smooth out (approximately one to two seconds). Tack welding is generally done at the same power setting that normal pipe welding will be done at (Pos. 4, 5, 6).

Now that the pipe is tacked into place, you are ready to weld the pipe. Once again, have 1/4" to 1/2" of welding wire protruding from the gas nozzle. Again, the welding gun is generally held at a 45 degree angle to the pipe. It also may be tilted at a 45 degree angle to the left or right. Rest the gas nozzle on the pipe and have the wire pointing at the spot where the welding is to begin. Press the trigger to begin welding. Slowly move the welding gun along the weld at a constant rate. A jerky, inconsistent, or too rapid rate will cause arc instability and a sputtering welding sound. A rate that is too slow will cause burn-through. It is also important that you position the welding gun so that you can see the welding wire as it comes out past the gas nozzle. The light produced from the wire coming in contact with the work is the only thing that will allow you to see the "seam" through the welding helmet. If the gas nozzle is blocking your view of the wire, then there will not be sufficient light to see the welding process.

HTP has a flexible swan neck (Part #15500) available for welding muffler pipe. The flexible swan neck makes it possible to bend the swan neck to get into hard to reach places and to get up over the top of the muffler pipe.

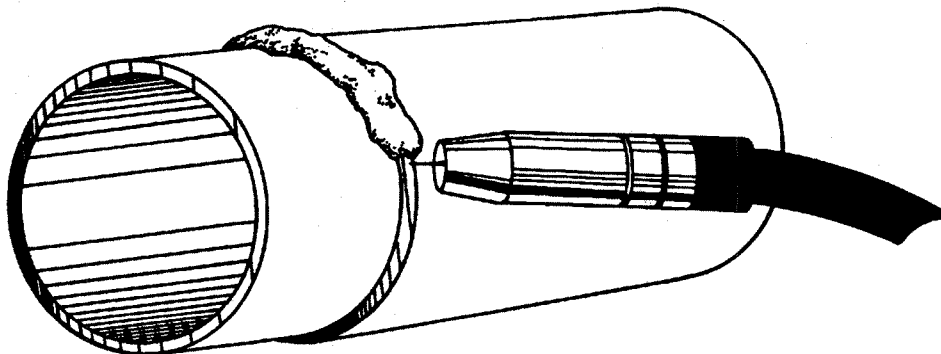

## BROKEN STUD REMOVAL

Your HTP MIG Welder can be used to remove exhaust manifold studs which have broken off flush or are protruding slightly from the exhaust manifold. In many instances, it is not even necessary to remove the exhaust manifold from the car.

Start with the power set at 5 or 6. This will ensure good adhesion of the molten wire to the stud. Point your wire directly at the stud and momentarily depress the trigger. Weld long enough to deposit a small puddle of molten wire on the stud and then allow it to cool. Repeat the process until you have built up a small amount of weld. Reduce the power to 4 or 5 and continue building the weld until 1/4" to 1/2" is protruding from the exhaust manifold. The lower power setting will allow you to build up the weld faster. Now take a 5/8" or 3/4" nut and place it on the stud. Turn the power back up to 5 or 6 and fill in the center of the nut, welding it to the stud.

Allow the stud to cool completely. Heat the exhaust manifold as you normally would and remove the stud. Shops have proven this process works 80% of the time.

## WELDING CAST IRON

Your HTP MIG Welder has the ability to weld cast iron using 75% Argon - 25% CO2 shielding gas and cast iron welding wire (Part #50235). The cast iron welding wire will also allow you to weld mild steel to cast iron.

When welding with the cast iron wire, welding techniques are the same as the welding techniques for mild steel. Due to the .035" diameter, wire feed rates for cast iron welding wire will be lower for a given power setting than the .030" diameter steel wire. However, the machine is tuned in the same way as with the steel wire, listening for the "sizzling" noise.

Depending on the thickness of the material, it may be desirable to preheat the casting to ensure adequate penetration. When welding a crack, it may be beneficial to "vee" out the crack. In order to reduce the possibility of further propagation, drill small holes at both ends of the crack. It is also a good idea to make short welds to reduce the possibility of overheating the cast iron around the weld area. Then immediately after welding, lightly tap (peen) the weld with a ball-peen hammer to stress relieve the weld area.

The more time spent in surface preparation of cast iron welds (cleaning the surface, veeing out cracks, etc.) the better the results and the stronger the weld will be.

## MAINTENANCE AND SERVICE

### Introduction

90% of the problems with MIG welders are wire feed/welding gun related. 98% of these problems are due to owner/operator abuse, misuse or ignorance.

The welding gun is exposed to the heat and spatter of welding. The NOZZLE SPRAY (Part #12021) should be sprayed on the inside of the gas nozzle, contact tip and swan neck with every use. The function of the nozzle spray is to prevent the spatter from adhering to the gas nozzle, contact tip and swan neck, making it easy to keep these parts clean. However, using the spatter spray does not eliminate the need to frequently clean the spatter from the gas nozzle. For this reason, HTP has available a NOZZLE REAMER (Part #12025). The nozzle reamer makes it very easy to keep your tips and nozzles clean.

Figure 9 shows the early symptoms of spatter build up. The exterior of the nozzle has arc marks on it from shorting out. You will also notice the nozzle sticking to the work and inconsistent weld quality when the nozzle shorts out.

Figure 10 shows a cutaway of a nozzle with spatter build up. This nozzle is ruined because the operator allowed the spatter to build up excessively, so the spatter has now welded itself to the inside of the gas nozzle.



(Fig. 9)  
Spatter Build Up Symptoms



(Fig. 10)  
Spatter Build Up



Figures 11 and 12 show what will happen to the swan neck if you do not keep your nozzle clean. Both figures illustrate that in extreme cases, shorting out the nozzle will burn holes completely through the swan neck requiring its replacement.

In Figure 11 is a deformed nozzle spring (13AK & 15AK guns only) pointing outward, so it will come in contact with the inside of the gas nozzle. In Figure 12, the nozzle spring is wound down around the base of the swan neck. These deformed springs are caused by improper removal of the gas nozzle. This again will cause the welding current to be transmitted to the exterior of the gas nozzle, once again causing a short circuit. **THE NOZZLE CAN ONLY BE REMOVED BY TWISTING IN A CLOCKWISE DIRECTION WHILE PULLING IT OFF.**

Figure 16 shows the effect of a wire drive mechanism that has been set just a little bit too tight. As you can see, the wire has been spiraled into the liner, resulting in the curvy wire. When the wire got to the contact tip, it could not pass through the contact tip smoothly, hence burning back to the tip. Since the wire could not pass through the tip, this same situation (spiraling wire) has now occurred at the other end of the welding gun. When it passes 10 feet through the welding gun, the wire will not be able to pass through the tip smoothly. If resetting the tension on the drive roller does not remedy this problem, then the liner should be replaced.

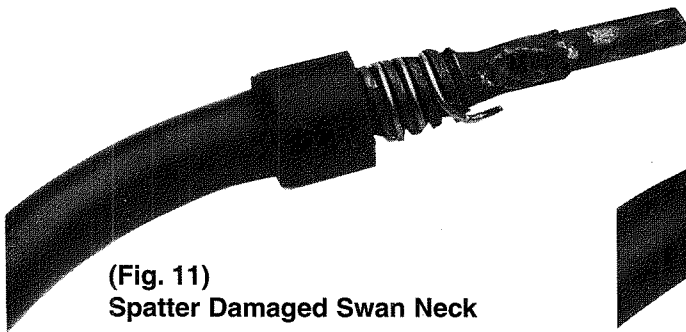

**(Fig. 11)**  
Spatter Damaged Swan Neck

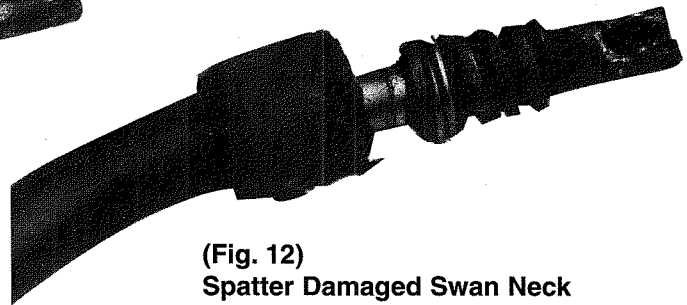

**(Fig. 12)**  
Spatter Damaged Swan Neck

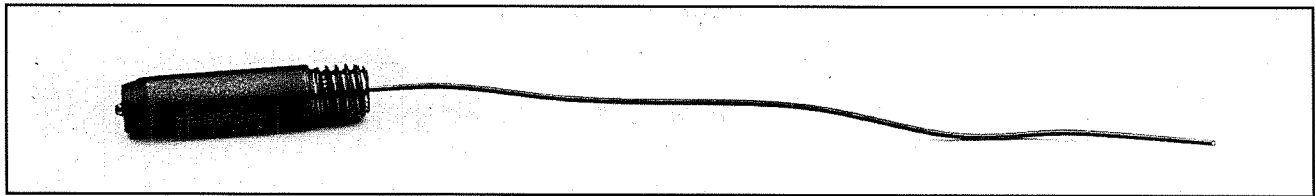

**(Fig. 16)** Spiraled Wire

## CHANGING THE CONTACT TIP

The contact should be regarded as a wearing part and therefore requires periodic replacement. Since steel wire is passing through a copper tip, the wire will have a tendency to wear away the copper tip, causing it to become oblong or excessively oversized. This one inch piece of copper is all that is taking the welding amperage and transferring it to the welding wire. Therefore, an excessively worn tip will cause poor electrical contact between the wire and the tip, resulting in a welder that will not weld smoothly.

To remove the contact tip, clip off the burnt wire at the end of the welding gun. Unscrew the contact tip. Install the new tip by feeding the wire through the hole in the center of the tip and screw the tip into the swan neck.

Part #	Fits Wire Size
15023B	.023" 0.6 mm
15030B	.030" 0.8 mm
15035B	.035" 0.9 mm
15040B	.040" 1.0 mm
15045B	.045" 1.2 mm

## CHANGING THE GAS NOZZLE

### 13AK & 15AK Guns

The gas nozzle is removed by simultaneously twisting the gas nozzle and pulling it off. The gas nozzle can only be twisted in a clockwise direction. Twisting the nozzle in a counter-clockwise direction will damage the nozzle spring. To install the gas nozzle, simply twist the nozzle in the same clockwise direction while pushing it on the swan neck. The following gas nozzles are available for your welding gun:

Part #	Description	Application
15105B	Conical Nozzle	General Welding
15004B	Cylindrical Nozzle	Aluminum Welding
15106B	Spot Weld Nozzle	Spot Welding
15108B	Small Conical Nozzle	Corner Welding

### Mini-MIG & #1 Guns

The gas nozzle is removed by unscrewing the nozzle from the gas diffuser in a counter clockwise direction. If the nozzle and the gas diffuser come off together, spatter has fused the two together. To install the gas nozzle, simply twist the nozzle in a clockwise direction and screw it back on to the gas diffuser. The following gas nozzles are available for your welding gun:

Part #	Description	Application
S4328	Conical Nozzle	General Welding
S4330	Cylindrical Nozzle	Aluminum Welding
S4329	Spot Weld Nozzle	Spot Welding

## SETTING THE PRESSURE ON THE PRESSURE ROLLER

Prior to readjusting the pressure roller, check the following:

1. Are the drive roller and pressure roller clean? If not, clean with a suitable solvent.
2. Is the liner worn, dirty or kinked, causing a restriction to the wire feed? (See testing and changing the liner.) If so, replace the liner.
3. Is the guide tube lined up properly with the drive roll? If not, align the guide tube.
4. Is the guide tube coming in contact with the drive rolls? If so, remove the guide tube and shorten it by grinding.

If all of the above mentioned conditions are in good working order, then it may be necessary to reset the pressure on the pressure roller.

1. Loosen the pressure roller adjusting screw (2), pull the pressure release handle (2) out of the way and lift the pressure roller assembly (4) up and out of the way.
2. Loosen the wire from the spool. Feed the wire into the inlet wire guide (5), across the drive roll (6) and into the guide tube (7) or liner in the case of the MIG 120. Check to be sure the groove in the drive roll is the correct groove for the wire diameter you are using. Feed the wire until two or three inches of straight wire protrudes from the central adapter block, or in the case of the MIG 120, feed until two to three inches of wire goes into the welding gun.
3. Swing the pressure roller assembly (4) back into position, making sure the wire is positioned in the groove of the drive roll (8). Tighten the pressure roller adjusting screw just enough to keep the wire in the groove. **DO NOT OVERTIGHTEN!**
4. Insert the wire protruding from the central adapter block into the end of the welding gun. Install the welding gun on the welding machine. (not necessary on MIG 120)

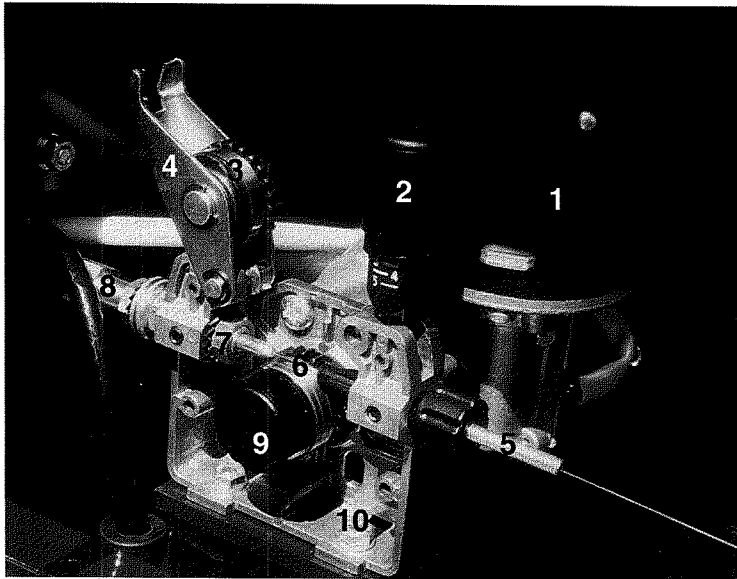

- 1) Drive Motor
- 2) Pressure Release Handle/  
Pressure Adjusting Screw
- 3) Pressure Roller
- 4) Pressure Roller Assembly
- 5) Inlet Wire Guide
- 6) Drive Roller
- 7) Guide Tube (all except 120)  
Liner (MIG 120)
- 8) Adapter Plug
- 9) Drive Roll Retaining Screw
- 10) Wire Drive Bracket

(Fig. 3)

5. Remove the contact tip and gas nozzle from the welding gun. Turn the wire feed rate to 6. Depress the trigger on the welding gun. At this point, the wire feed will be inconsistent because the majority of tension has been removed from the pressure roller. Slowly tighten the pressure roller adjusting screw until the wire feeds evenly without slipping. Then tighten an additional 1/4 turn for steel. No additional tightening is necessary for aluminum. **DO NOT OVERTIGHTEN!**

Continue feeding the wire until it appears at the tip of the welding gun. Check your wire size and install the correct contact tip. Install the gas nozzle.

6. Bend the welding wire 90 degrees and hold the welding gun perpendicular to a non-conductive surface (concrete floor) so that the wire will not feed. While looking at the wire feed mechanism, momentarily depress the trigger. The drive roll should slip and act as a clutching mechanism. If not, the drive roll will push the wire out between the roller and the guide tube. This is known as "bird nesting." If bird nesting occurs, the pressure roller has been adjusted too tightly. When properly adjusted, the drive roll will slip, and "bird nesting" will never occur.

## CHANGING THE DRIVE ROLL

The drive roll has two grooves on it. The narrower of the two grooves is marked 0.6 and is used for .023" wire. The wider groove, marked 0.8, is used for .030" and .035" wire.

To change the drive roll, simply remove the drive roll retaining screw (11) and remove the drive roll (10) from the adapter ring. Select the correct groove, and install the drive roll so that the proper groove lines up with the inlet wire guide (29) and the guide tube. Install drive roll retaining screw.

## REPLACING THE PRINTED CIRCUIT BOARD (PCB)

The PCB is a very reliable part of your HTP welder. Should failure occur, it usually happens within the first five minutes of operation and is caught during the initial test period at the factory. However, should failure occur, replacement is very simple.

1. UNPLUG MACHINE.
2. Remove the two screws which hold the side panel on.
3. Remove the 2 clips holding the multi pin connector on.
4. Gently disconnect the multi pin connector from the circuit board.
5. Pry the two plastic retaining clips which hold the circuit board in the groove back and slide the circuit board up and out of the grooves. On the MIG 140, be careful not to snag the wires from the control knobs on the back of the circuit board.
6. Installation is the reverse of the above.

## TESTING AND CHANGING THE LINER

Should feeding problems occur, the first item to be checked should be the liner. The following check should be made to determine if the liner is defective:

1. Feed 12" to 18" of fresh wire out of the welding gun. (See Fig. 17.)
2. Disconnect the welding gun from the machine with the wire still threaded in the gun. Pull the gun 6" away from the machine and clip the wire so that 6" of the wire is extending out of the welding gun. (See Fig. 18.)
3. Push the wire in and out of the welding gun as shown in Fig. 19. The wire should move freely in the gun with little or no resistance. If there is a great deal of friction, the liner should be replaced.

To replace the liner, remove the liner positioner nut with a 12mm wrench (8mm for MIG 120) and pull the old liner completely out of the welding gun (See Fig. 20). Remove the gas nozzle and contact tip. If installing a teflon liner, install the collet on the liner. Slowly push the new liner into the welding gun. (See Fig. 21.) Be careful not to try to push too much liner into the gun at one time, or the liner may kink. Lay the welding gun out straight and install the liner positioner nut. Clip the excess liner off flush with the end of the swan neck. Use a razor blade on teflon liners. (See Fig. 22.) Coil the welding gun, and cut an additional 1/8" to 3/16" from the liner. Install the correct size contact tip.

Part #	Description
13AK & 15AK Mini MIG #1	
15040 S4331 x040	Steel liner — for flex neck or standard swan neck — steel welding only
15044 S4325 15041	Teflon liner — for flex neck or standard swan neck — aluminum welding only

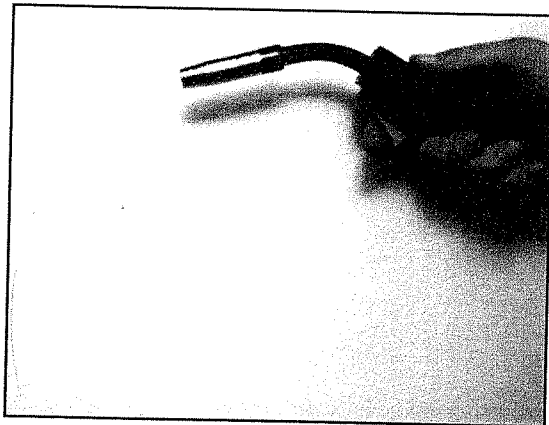

(Fig. 17)

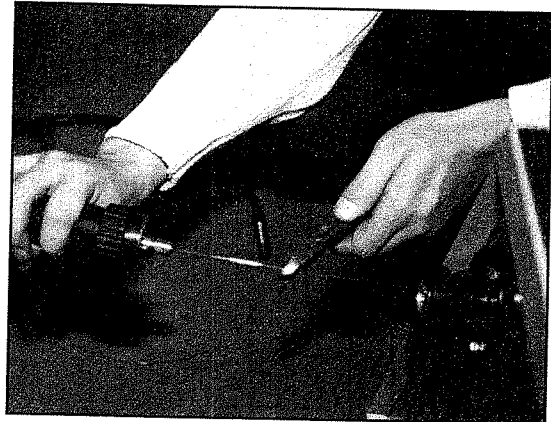

(Fig. 18)

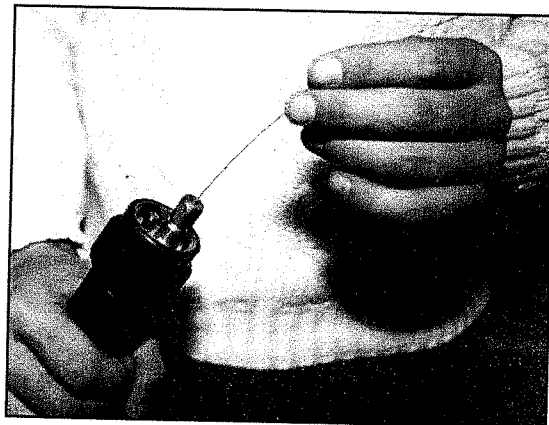

(Fig. 19)

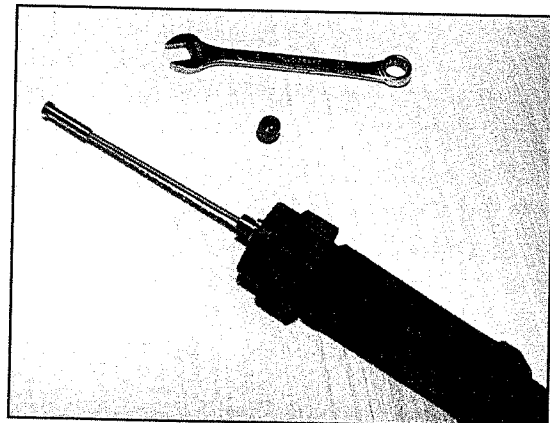

(Fig. 20)

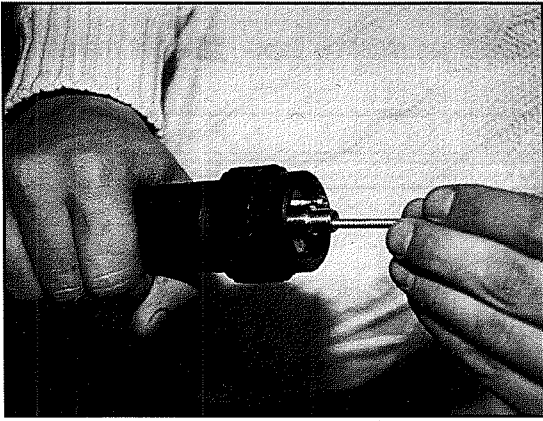

(Fig. 21)

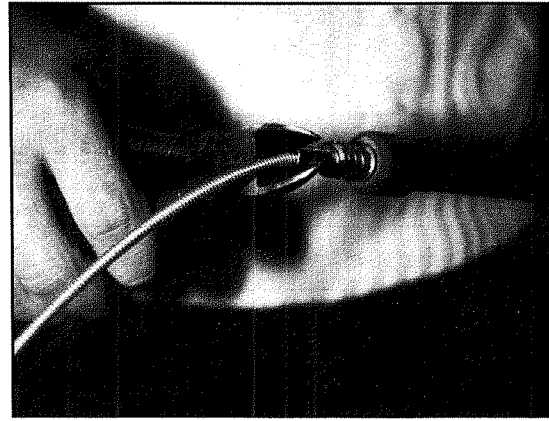

(Fig. 22)

## CHANGING THE SWAN NECK (13AK & 15AK GUNS)

In the event that excessive spatter has been allowed to build up and damage the swan neck, it will be necessary to change the swan neck.

1. Twist handle lock ring (#4) and remove from the end of the handle. (See MB-13 AK diagram.)
2. Split the handle (#'s 3, 2) in half.
3. Put the hex fitting at the end of the power cable (#36) in a vise. Loosen the locknut on the swan neck (#1) with a wrench.
4. Unscrew the swan neck from the power cable. Remove the swan neck from the handle half (#3).
5. Place the new swan neck through the handle half. Screw the swan neck as far into the cable assembly as possible.
6. On welding guns equipped with the standard swan neck, the bend in the swan neck must line up with one of the points in the hex fitting of the power cable. If this is not done, then the swan neck will not line up properly with the trigger.
7. Tighten the locknut securely.
8. On Flex Neck Guns only, spray the base of the swan neck and the inside swan neck supporting areas of the handle halves with the nozzle spray. This will act as a lubricant and make it easier to put back together.
9. Put the handle halves back together and install handle lock ring.

## MONTHLY MAINTENANCE

Your HTP MIG Welder is a very hardworking piece of equipment and is very simple to maintain. However, your HTP MIG Welder is more complicated than other types of welding equipment. It is very important that these simple maintenance procedures be followed to keep your welder operating trouble free.

1. **Wire Drive System** — The guide tube and inlet wire guide should be checked periodically to ensure that they are in correct alignment with the drive rolls. Misalignment will result in the copper plating of the wire being rubbed off. This copper dust will be carried into the liner resulting in increased friction causing wire feed problems.
2. **Welding Cable** — You should not allow heavy equipment to run over the welding cable. Avoid pulling the machine by the cable.  
  
Do not pull the welding cable over sharp edges.
3. **Transformer and Internal Components** — Your MIG Welder is equipped with a thermostick to protect the internal components of your welder should the duty cycle be exceeded. The thermostick is placed in the low voltage circuit, so that when the duty cycle is exceeded, the main relay will not operate, preventing power from going to the main transformer. The indicator light will remain on, the wire will not feed, and the on machines equipped with cooling fans, the fans will remain on. When the machine cools down (approximately 20 minutes) the thermostick will automatically reset itself and the machine will be ready for use.

To keep the cooling system of your welder operating at peak performance, it is necessary to remove the side panel and blow this area out with dry, compressed air. This will remove dirt and dust from the internal components.

## SHIELD GAS

Since no flux is used for solid wire MIG welding, the proper shield gas must be used. Different materials require different shield gases. Use the chart below for a guide.

Material	Shield Gas	Flow Rate
Steel	75% Argon - 25% CO <sub>2</sub>	10-35 cfh
Aluminum	100% Argon	30-50 cfh
Stainless Steel	90% Helium + 7.5% Argon + 25% CO <sub>2</sub>	15-35 cfh
Brazing	100% Argon	15-35 cfh
Cast Iron	75% Argon - 25% CO <sub>2</sub>	25-35 cfh

Use a gas regular such as HTP Part #12020 which is compatible with both Argon and C-25 gas cylinders and has a barbed fitting for the delivery hose. Connect the gas hose to the brass fitting at the rear of the machine and to the barbed fitting on the regulator.

HTP also has available small 60 cubic foot gas bottles (Part #99900), which are ideal for use with your welder. These bottles stand approximately 30" high and weigh less than 40 pounds, making your welder very easy to move around the shop. Be sure to check with your local gas supplier about filling these tanks before ordering.

If you already have a large cylinder, you can fill the small cylinder from the large cylinder using the transfer manifold (HTP Part #99905).

*NOTE: 75% Argon- 25% CO<sub>2</sub> may be used for stainless steel welding. Stainless steel can also be welded with steel wire and 75% Argon - 25% CO<sub>2</sub> gas, however, these welds will not be as corrosion resistant as welds made with stainless steel wire.*

## WELDING WIRE

HTP has a wide variety of welding wire available. For autobody repair, we strongly recommend the following wires:

Application	Part #	Description
Steel	21023	.023" E70S-6 Steel Wire
Aluminum	40230	.030" 5356 Alloy Aluminum Wire

We are typically finding body panels being made from 22 gauge (.0299" thick), 24 gauge (.0239" thick) and 26 gauge (.0179" thick) steel. When welding this thin metal, the secret to minimizing distortion and burn-through is by using a wire which will require the least amount of heat to melt. This would be the thinnest wire available, .023" diameter in steel and .030" diameter in aluminum.

For muffler work and general repair welding, we are generally working on thicker materials. We therefore recommend using part #21030, .030" steel wire. This wire will give greater penetration and less feeding problems.

For other applications, use the following chart as a guide:

Application	Part #	Description
Steel (30 ga-1/8")	21023	.023" E70S-6 Steel Wire
Steel (16 ga-1/4")	21030	.030" E70S-6 Steel Wire
Steel (14 ga-1/2")	21035	.035" E70S-6 Steel Wire
Aluminum (24 ga - 1/8")	40230	.030" 5356 Alloy Aluminum Wire
Aluminum (16 ga - 1/4")	40235	.035" 5356 Alloy Aluminum Wire
Stainless Steel (24 ga-1/8")	38223	.023" Stainless Steel Wire
Stainless Steel (18 ga-1/4")	38230	.030" Stainless Steel Wire
Cast Iron	50235	.035" Cast Iron Wire
Bazing	50230	.030" Silicon Bronze Wire
Steel W/O Gas (16 ga-1/4")	61030	.030" Flux Cored Wire
Steel W/O Gas (16 ga-1/4")	61035	.035" Flux Cored Wire

All HTP steel welding wires are AWS grade E70S-6. This is a high quality welding wire with additives to reduce spatter and offer better wetting characteristics on rusty material. Also, this is the only grade of welding wire that is compatible with the High Strength Low Alloy steels found in today's unibody vehicles.

# Parts Breakdown – MB-13AK Welding Gun

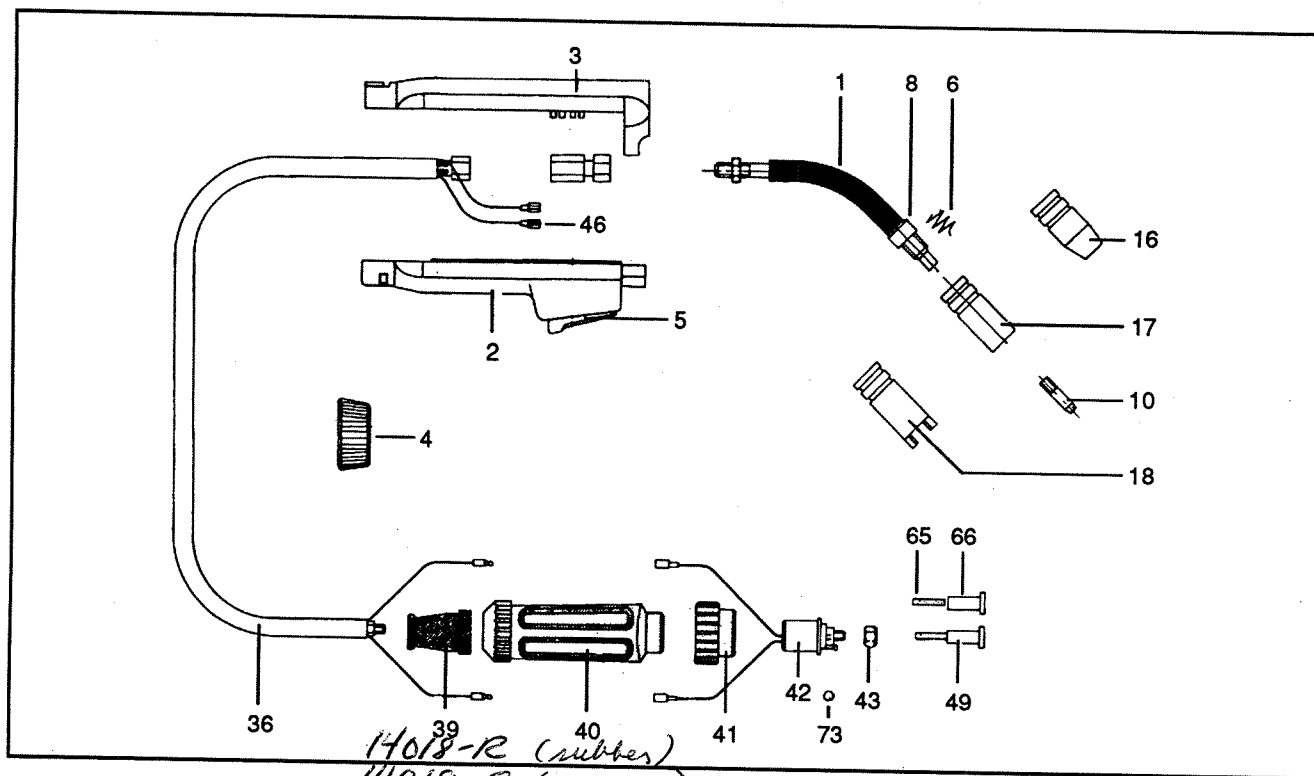

## MB-13AK Welding Gun

Illustration	Part #	Description
1	13002	Swan Neck
	15500	Flexible Swan Neck
2-4	14008	Handle Assembly - for Standard Swan Neck
	14508	Handle Assemble - for Flexible Swan Neck
5	14009	Trigger Switch
6	15062	Nozzle Spring
8	14058	Head Insulator
10	15023	.023" Contact Tips
	15030	.030" Contact Tips
	15035	.035" Contact Tips
16	15105	Conical Nozzle w/Extra Insulation
	15108	Small Conical Nozzle
17	15004	Cylindrical Nozzle
18	15106	Spot Weld Nozzle w/Extra Insulation
36	13010	Power Cable - 10'
	13012	Power Cable - 12'
	13015	Power Cable - 15'
<del>39</del> 40	14021	Adapter Support
41	14022	Adapter Nut
42	14041	Liner Positioner Nut
49	15040	Liner - Steel Welding Only - Standard or Flexible Swan Neck
65	14042	Collet
73	14000	O-Ring
	13100	10' MB-13AK Welding Gun
	13120	12' MB-13AK Welding Gun
	13150	15' MB-13AK Welding Gun
	13510	10' MB-13AK Flex Neck Welding Gun
	13512	12' MB-13AK Flex Neck Welding Gun
	13515	15' MB-13AK Flex Neck Welding Gun

## Parts Breakdown – MB-15AK Welding Gun

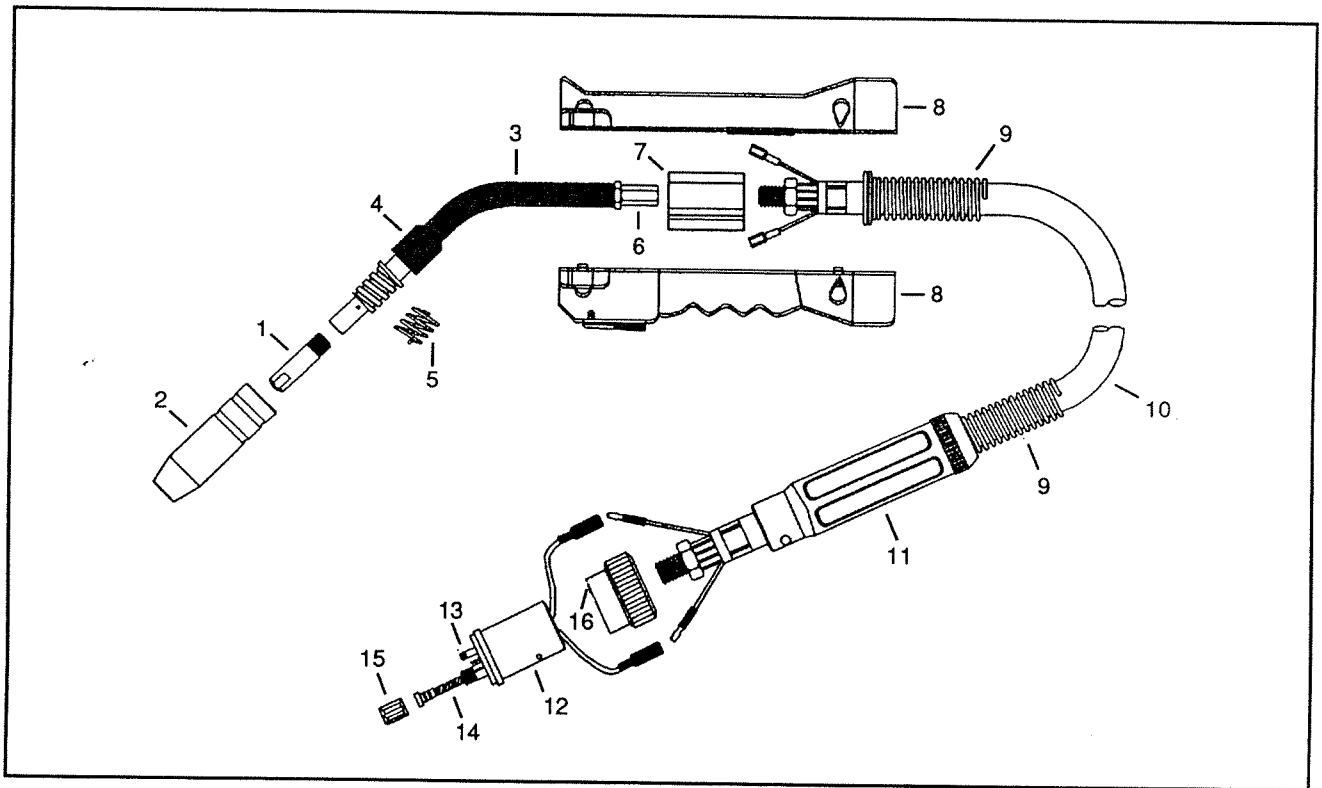

### MB-15AK Welding Gun

Illustration	Part #	Description
1	15023	.023" Contact Tip
	15030	.030" Contact Tip
	15035	.035" Contact Tip
2	15105	Conical Nozzle
	15104	Cylindrical Nozzle
	15106	Spot Weld Nozzle
	15007	Stud Nozzle
	15108	Small Conical Nozzle
3	15002	15AK Swan Neck
4	14058	Head Insulator
5	15062B	Nozzle Springs
6	15067	Hex Coupler
7	15072	Body Insulator
8	15008	15AK Handle Assembly w/Trigger
9	14018-S	Cable Support (Spring Style)
10	15010	10' 15AK Power Cable
	15012	12' 15AK Power Cable
	15015	15' 15AK Power Cable
11	14021	Adapter Support
12	14025	Adapter Block
13	14000	O-Ring
14	15040	Steel Liner (16')
	15044	Teflon Liner (16')
15	14041	Liner Position Nut
16	14022	Adapter Nut
	15100	10' 15AK Welding Gun
	15120	12' 15AK Welding Gun
	15150	15' 15AK Welding Gun



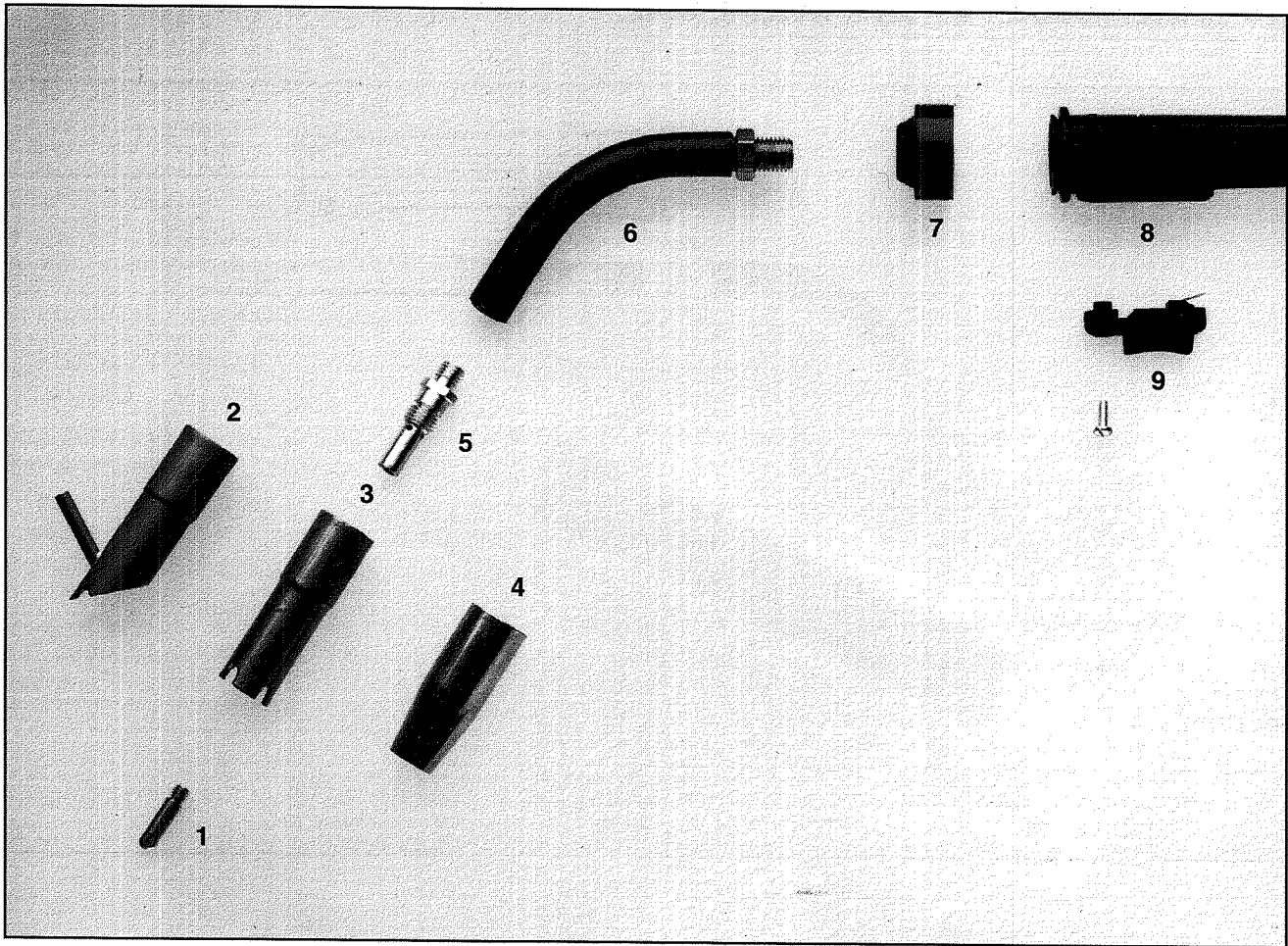

## Tweco Mini MIG

### Type Tweco Mini-MIG Torches

Illustration	Part #	Description	Tweco #
1	15023B	.023" Contact Tips (Pkg 5)	11-23
	15030B	.030" Contact Tips (Pkg 5)	11-30
	15035B	.035" Contact Tips (Pkg 5)	11-35
2	S4332	Stud Welding Nozzle	21-26-SAS
3	S4329B	Stud Welding Nozzle (Pkg 3)	21-62-FAS
	S4330B	Cylindrical Nozzle (Pkg 3)	21-62
4	S4328B	Cylindrical Nozzle (Pkg 3)	21-50
5	S4228	Gas Diffuser	35-50
6	S4227	Conductor Tube - Complete	35-60
	15500-T	Flexible Conductor Tube	
7	S1008	Handle Assembly	35-80
8	S1009	Trigger Switch	35-90

## Parts Breakdown – #1 Style Welding Gun

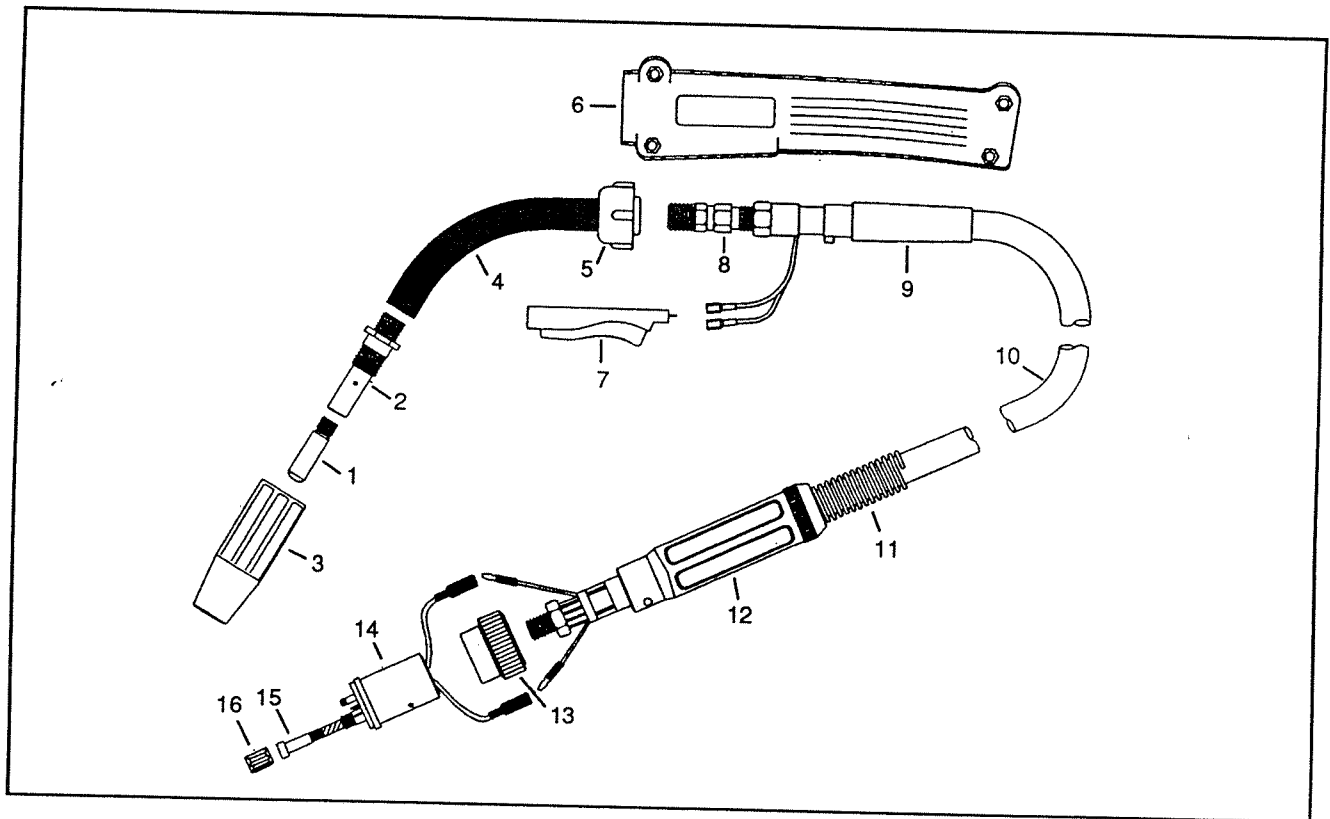

### #1 Style Welding Gun

Illustration	Part #	Description
1	15023	.023" Contact Tip
	15030	.030" Contact Tip
	15035	.035" Contact Tip
2	S4228-1	Gas Diffuser f/Tweco #1
3	S4328	Conical Nozzle
	S4329	Spot Weld Nozzle
	S4332	Stud Nozzle
4	61-60	Conductor Tube 60 Degree
5	K61R	Conductor Tube Retaining Nut
6	K81TWC	Handle f/Tweco #1 w/Screws
7	B5662	Trigger f/Tweco #1
8	K101R	Cable Connector w/Nut
9	K141-6	Cable Support (Rubber)
10	K200-10E	Power Cable - 10'
	K200-12E	Power Cable - 12'
	K200-15E	Power Cable - 15'
11	14018-S	Cable Support (Spring Style)
12	14021	Adapter Support
13	K174X-2	Adapter Nut f/Tweco #1
14	K174EX-1	Adapter Block f/Tweco #1
15	X040	Steel Liner (16')
	15041	Teflon Liner (16')
16	K174X-1C	Liner Position Nut
	X110	10' #1 Style Gun
	X112	12' #1 Style Gun
	x 115	15' #1 Style Gun

# Internal Components – MIG 120

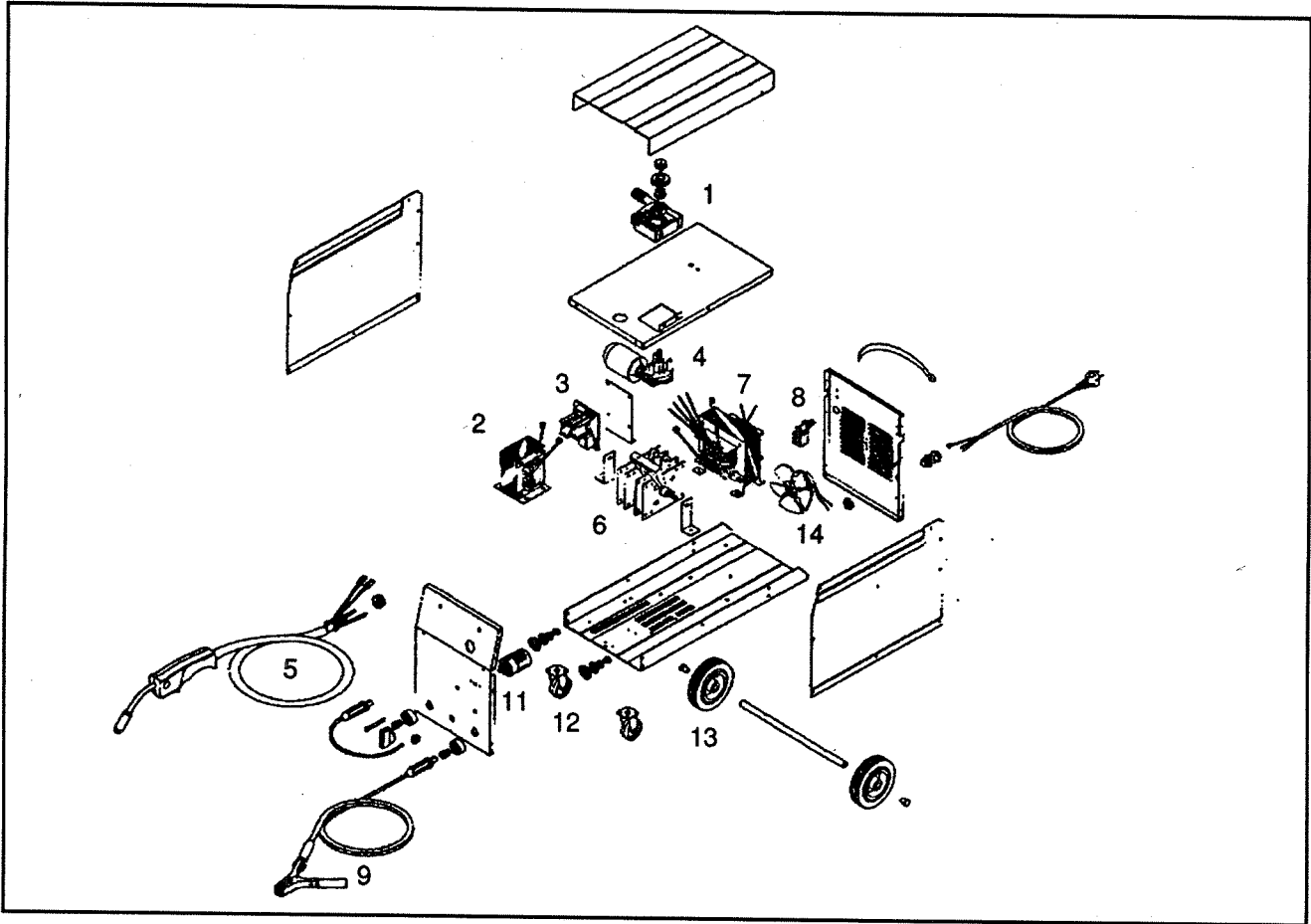

Item #	Description	Part #
1	Wire Drive Bracket	3110
2	Choke Coil	470040969
3	Printed Circuit Board (VAR-06R)	001976892
4	Wire Drive Motor	001764999
5	Welding Gun	14410
6	Rectifier	001962276
7	Main Transformer	470040879
8	Gas Solenoid Valve	001955127
9	Ground Clamp	22310
10	Female Ground Receptacle	20320
11	Power Switch	001951231
12	Front Caster	001754111
13	Rear Wheel	001754110
14	Fan Motor	001974255
	Fan Blade	001974230

## Internal Components – MIG 140

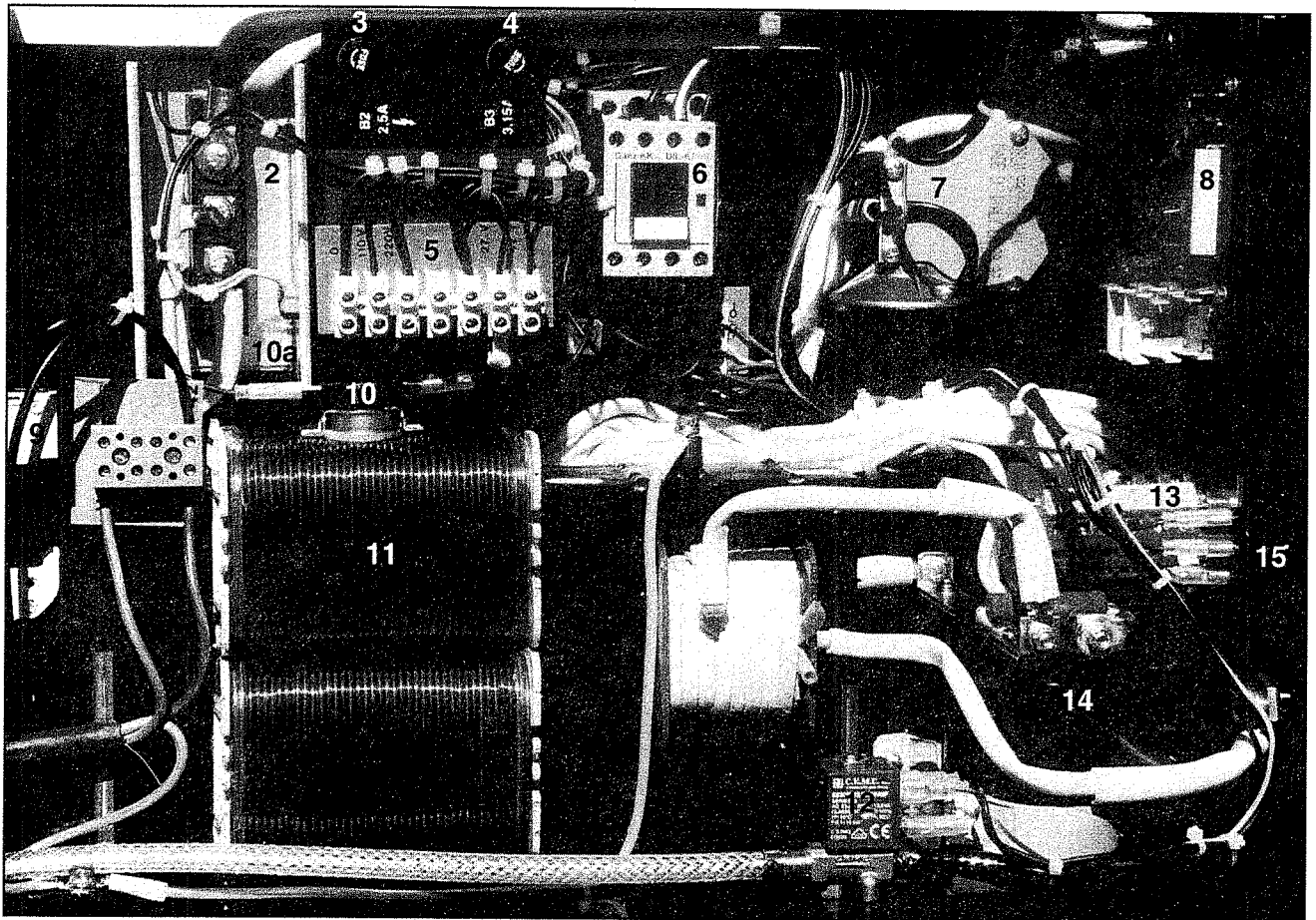

Item #	Quan	Description	Part Number
1	1	Cooling Fan	T3548500001
2	1	Electronic Rectifier/Power Block	T3548801001
3	1	Fuse	20335-2.5
4	1	Fuse	20335-3.15
	2	Fuse Holder	T1543190001
5	1	Control Transformer	T2005759000
6	1	Main Relay	T1541490034
7	1	Wire Drive Motor	T1555113019
8	1	Printed Circuit Board	T3548400202
9	1	Circuit Breaker	T1544701010
10	1	Thermo-Switch (Main Transformer)	T3548300008
10a	1	Thermo-Switch (Rectifier)	T3548300121
11	1	Main Transformer	T35483001902
12	1	Gas Solenoid Valve	T3548500180
13	1	6 Position Main Switch	T3548300002
14	3	Condensor	T1581900013
15	1	On-Off Switch	T3548300009
	1	Resistor	T1812468004
	1	Wire Drive Motor	T1555113019

## Internal Components – MIG 160

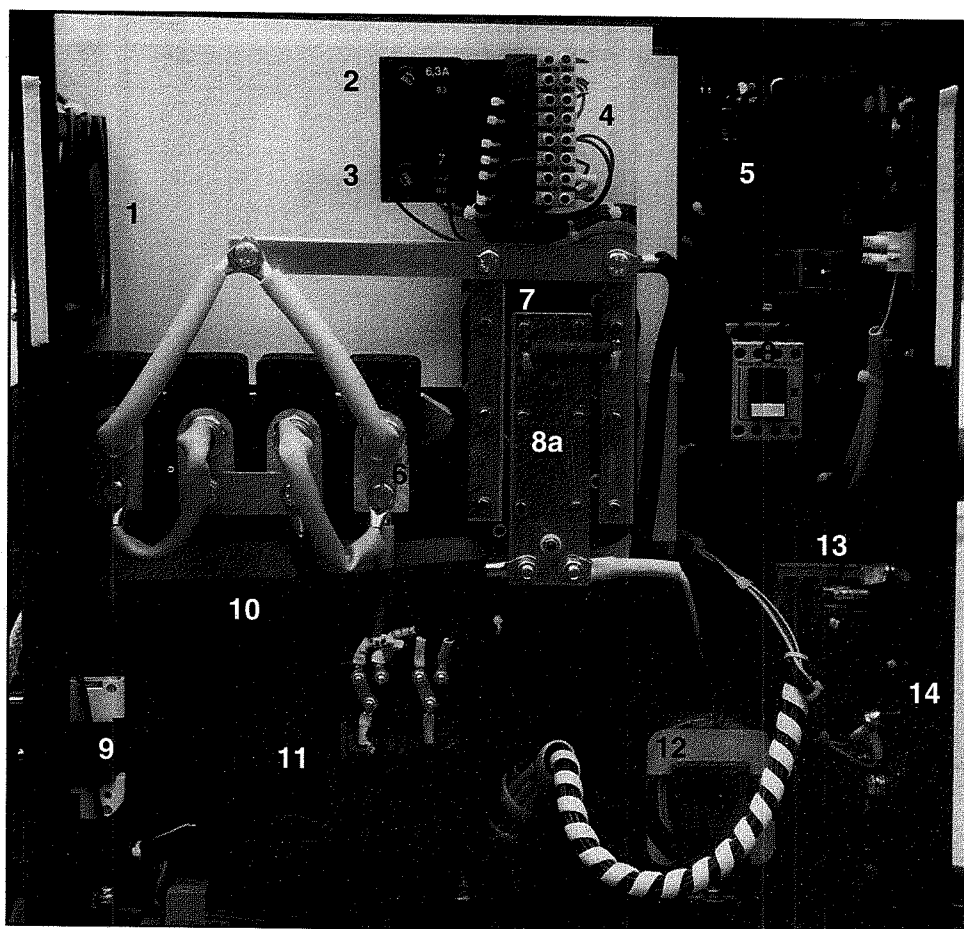

Item #	Quan	Description	Part Number
1	1	Cooling Fan	T3548500001
2	1	Fuse	20335-3.15
3	1	Fuse	20335-1.6
	2	Fuse Holder	T1543190001
4	1	Control Transformer	T2005760000
5	1	Printed Circuit Board	T3548400202
6	4	Diode	T3548101300
7	6	Condensor	T1581900013
8	1	Main Relay	T1541490034
8a	1	Resistor	T1812468000
9	1	Circuit Breaker	T1544702010
10	1	Thermo-Switch (Main Transformer)	T3548300008
11	1	Main Transformer	T4278702001
12	1	Choke Coil	T42787030001
13	1	8 Position Main Switch	T3548300012
14	1	On-Off Switch	T3548300016
	1	Gas Solenoid Valve	T3548500180
	1	Wire Drive Motor	T3548600004

## Internal Components – MIG 160DV

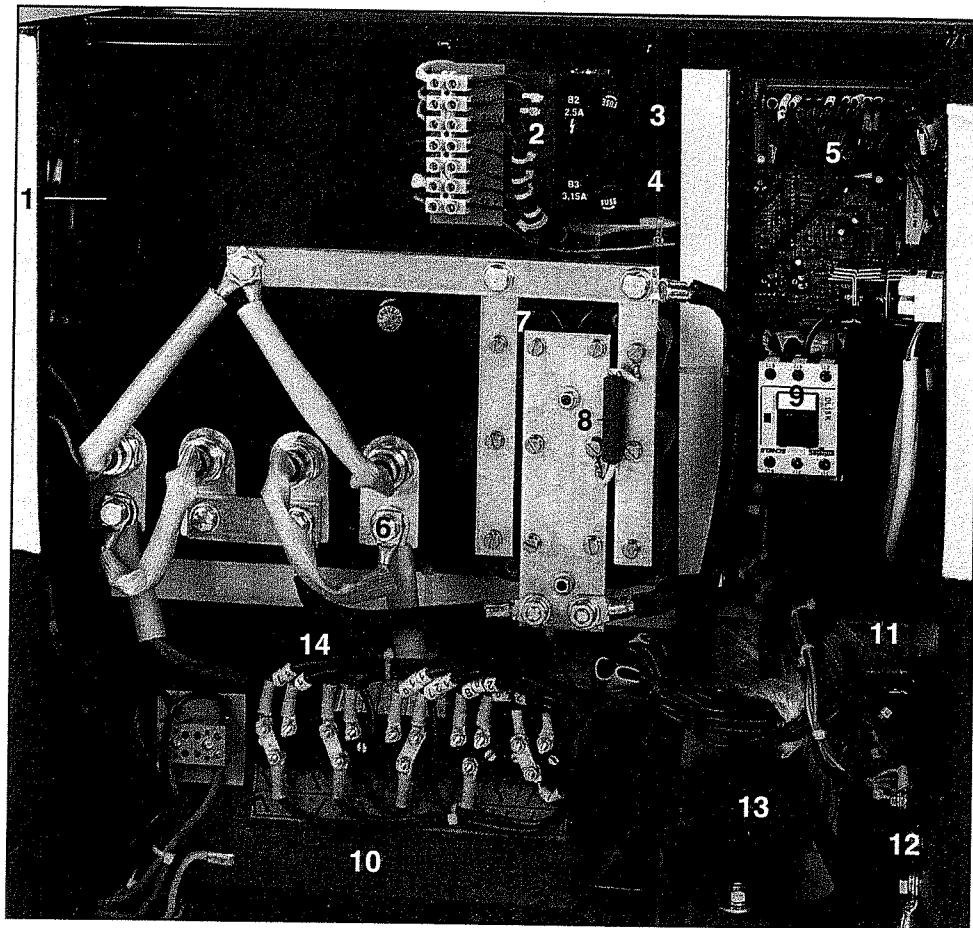

Item #	Quan	Description	Part Number
1	1	Cooling Fan	T3548500001
2	1	Control Transformer	T2005760000
3	1	Fuse	20335-2.5
4	1	Fuse	20335-3.15
	2	Fuse Holder	T1543190001
5	1	Printed Circuit Board	T3548400202
6	4	Diode	T3548101300
7	6	Condensor	T1581900013
8	1	Resistor	1-6011000160
9	1	Main Relay	1-6551501542
10	1	Main Transformer	4-2787320001
11	1	8 Position Main Switch	3-6520146459
12	1	On-Off Switch	T3548300016
13	1	Choke Coil	T42787030001
	1	Gas Solenoid Valve	T3548500180
	1	Wire Drive Motor	T3548600004
14	1	Thermo Switch	T3548300008

## Internal Components – MIG 200

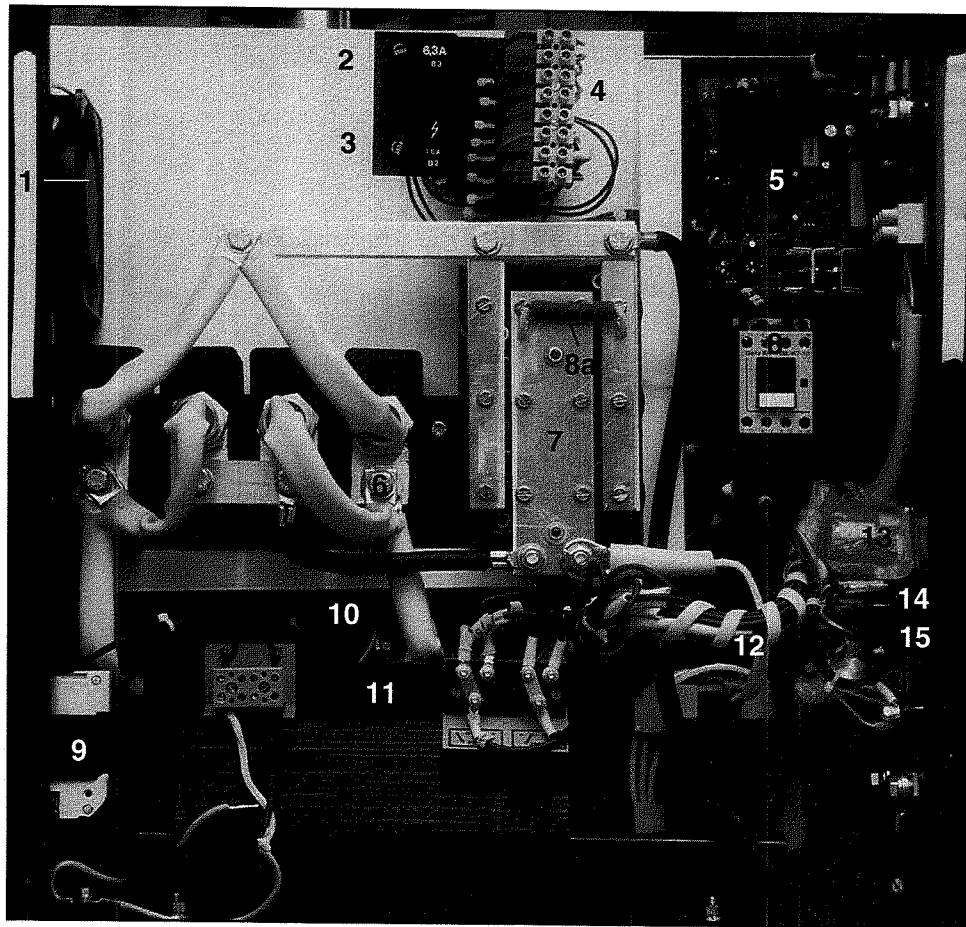

Item #	Quan	Description	Part Number
1	1	Cooling Fan	T3548500001
2	1	Fuse	20335-3.15
3	1	Fuse	20335-1.6
	2	Fuse Holder	T1543190001
4	1	Control Transformer	T2005760000
5	1	Printed Circuit Board	T3548400202
6	4	Diode	T3548102401
7	6	Condensor	T1581900013
8	1	Main Relay	T1541490034
8a	1	Resistor	T1812468000
9	1	Circuit Breaker	T1544701010
10	1	Thermo-Switch (Main Transformer)	T3548300008
11	1	Main Transformer	T4278822001
12	1	Choke Coil	T42788230001
13	1	6 Position Main Switch	3-6520138265
14	1	On-Off Switch	T3548300016
15	1	4 Position Main Switch	T3548300010
	1	Gas Solenoid Valve	T3548500180
	1	Wire Drive Motor	T3548600004

## Internal Components - MIG 240

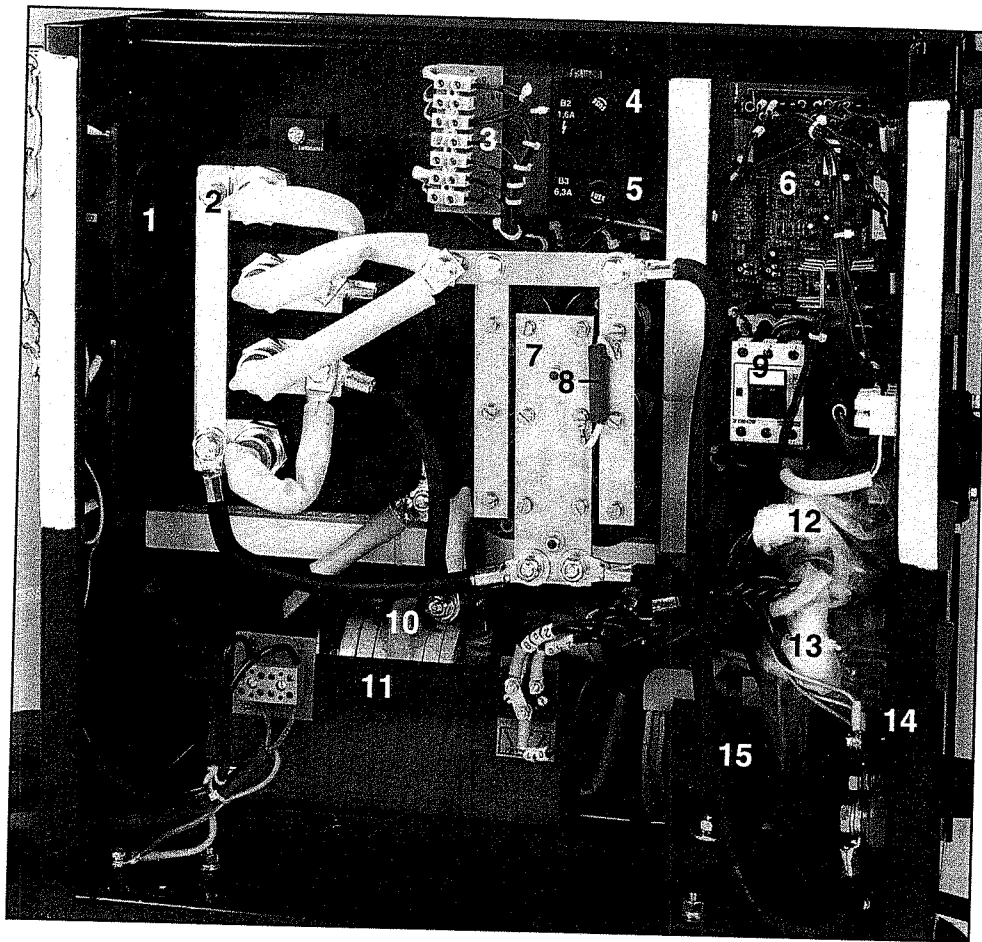

Item #	Quan	Description	Part Number
1	2	Cooling Fan	T3548500001
2	4	Diode	T3548102401
3	1	Control Transformer	4-2788440001
4	1	Fuse	20335-1.6
5	1	Fuse	20335-6.3
	2	Fuse Holder	T1543190001
6	1	Printed Circuit Board	T3548400202
7	6	Condensator	T1581900013
8	1	Resistor	1-6011000160
9	1	Main Relay	1-6551501542
10	1	Thermo Switch	T3548300008
11	1	Main Transformer	4-2788420001
12	1	4 Position Main Switch	3-6520148575
13	1	6 Position Main Switch	3-6520148576
14	1	On-Off Switch	T3548300016
15	1	Choke Coil	4-2778430001
	1	Gas Solenoid Valve	T3548500180
	1	Wire Drive Motor	T3548600004



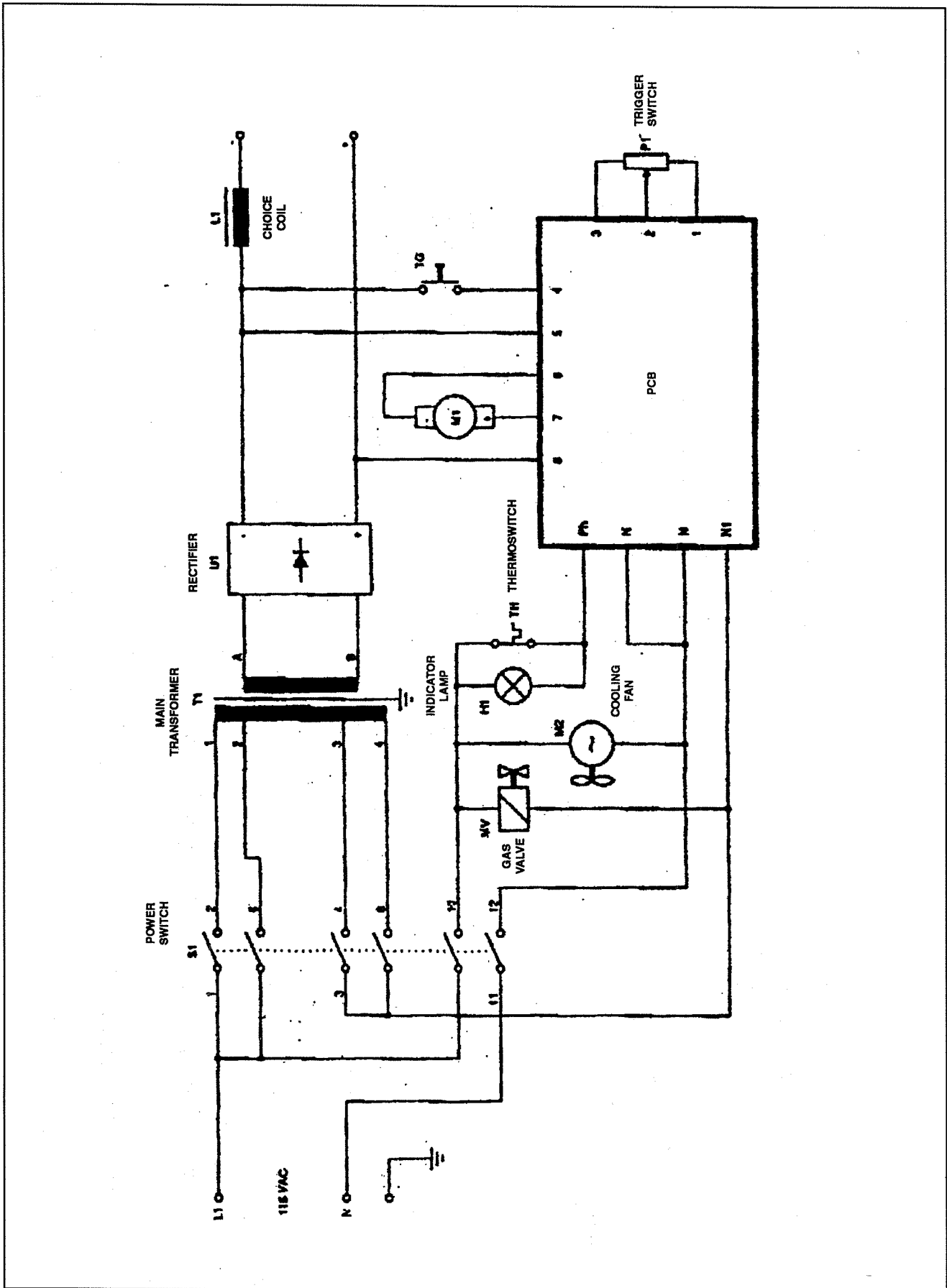

HTP MIG 120 WIRING DIAGRAM



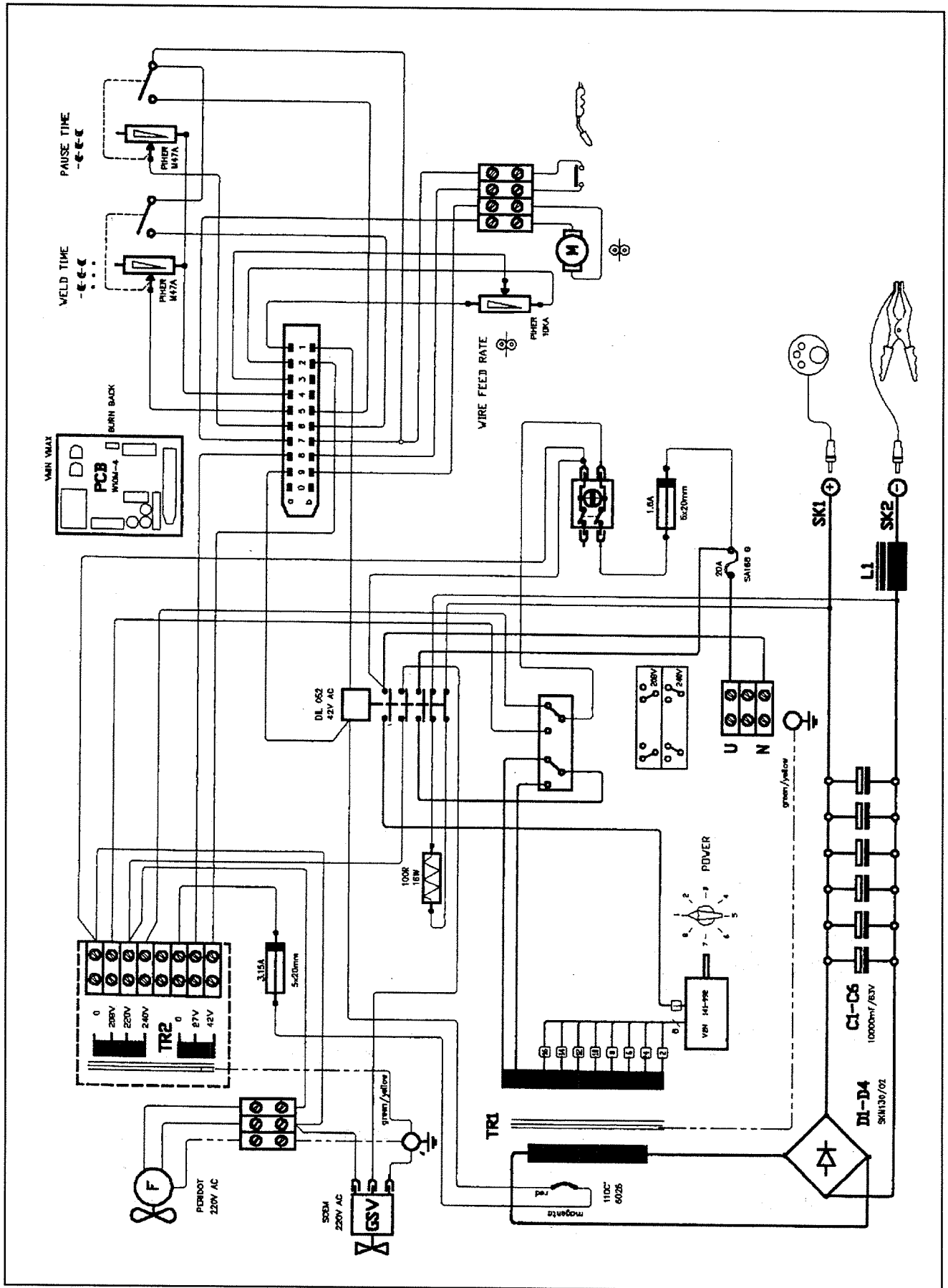

HTP MIG 160 WIRING DIAGRAM

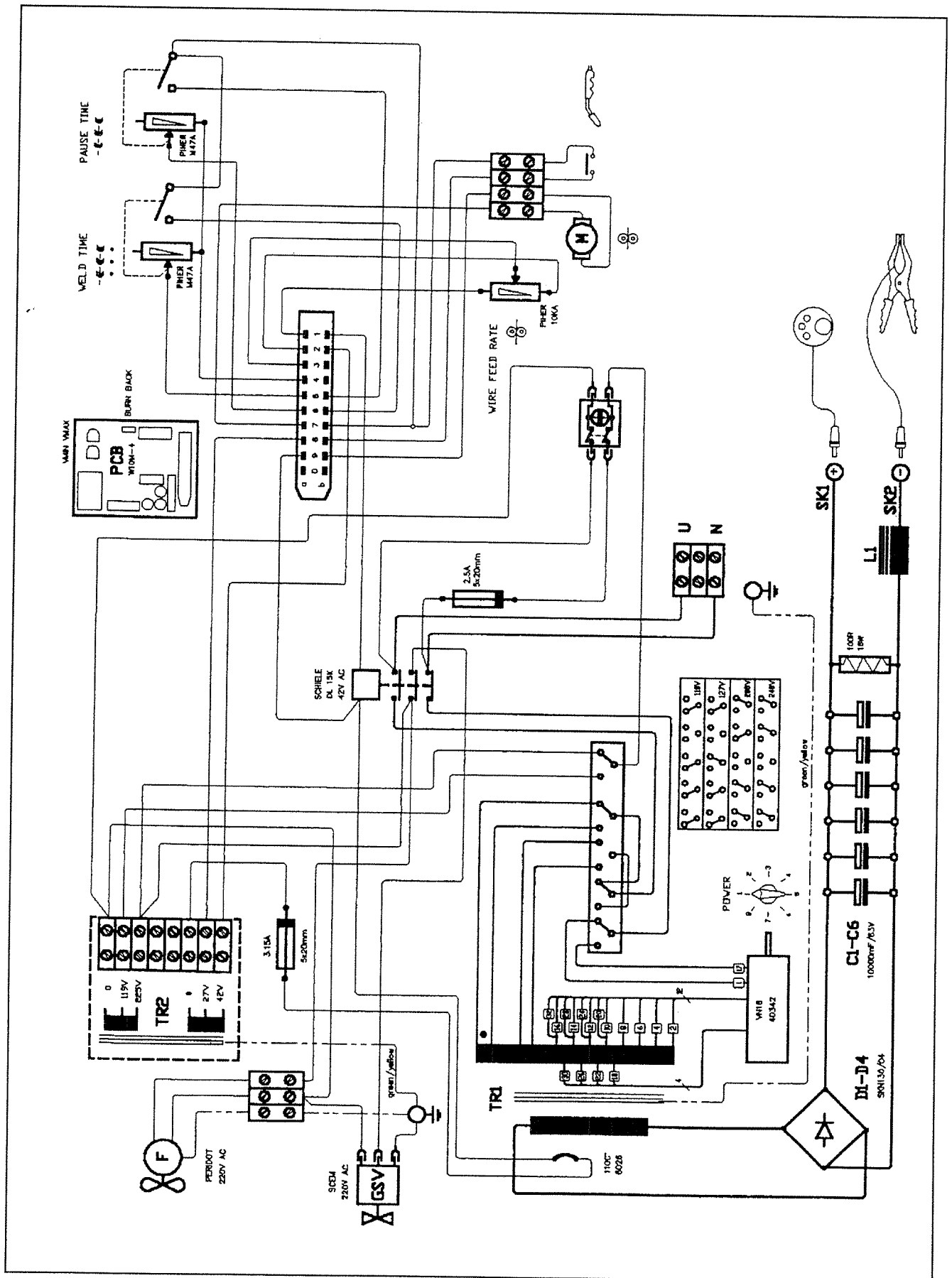

HTP MIG 160DV WIRING DIAGRAM

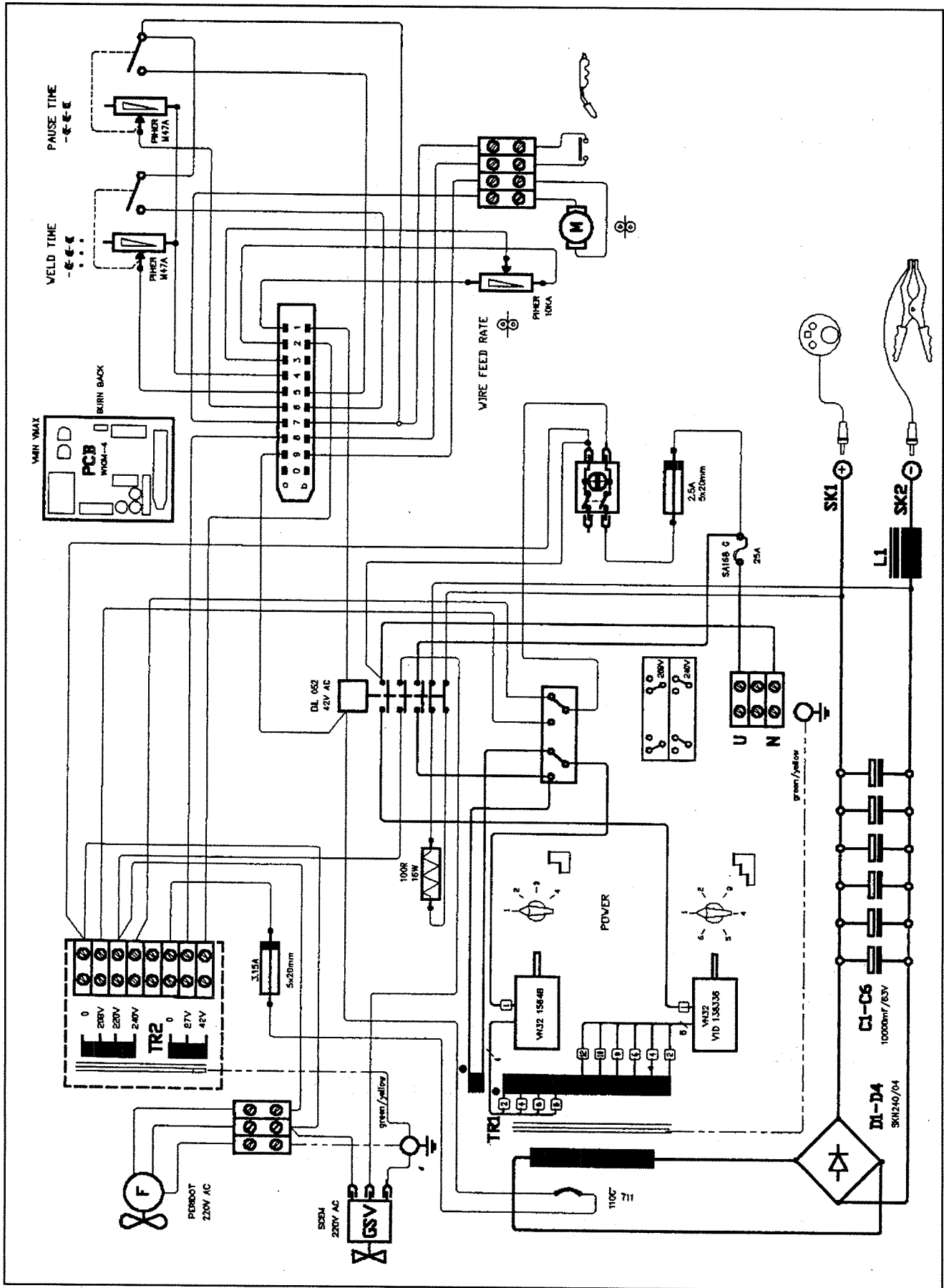

HTP MIG 200 WIRING DIAGRAM

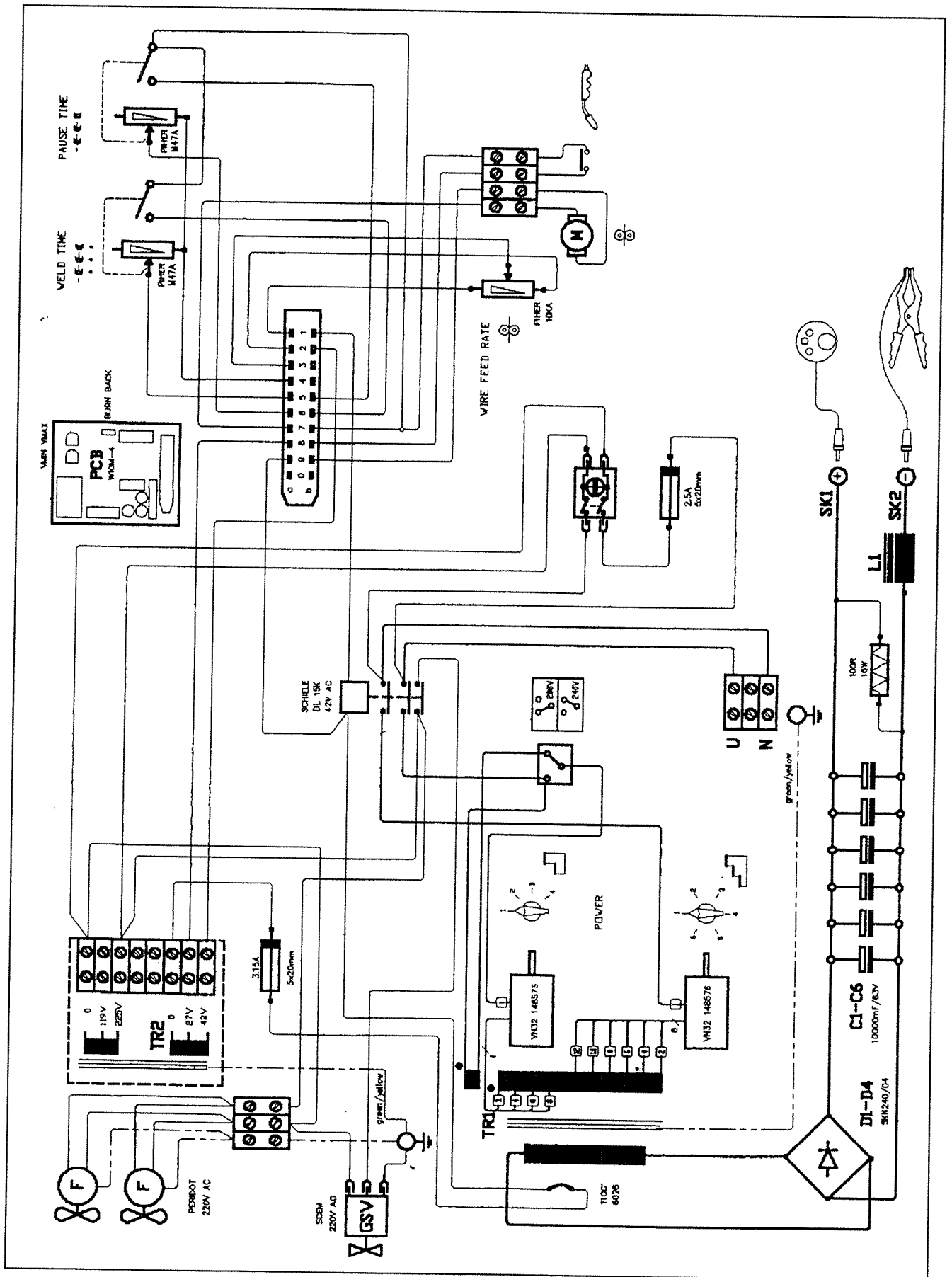

HTP MIG 240 WIRING DIAGRAM

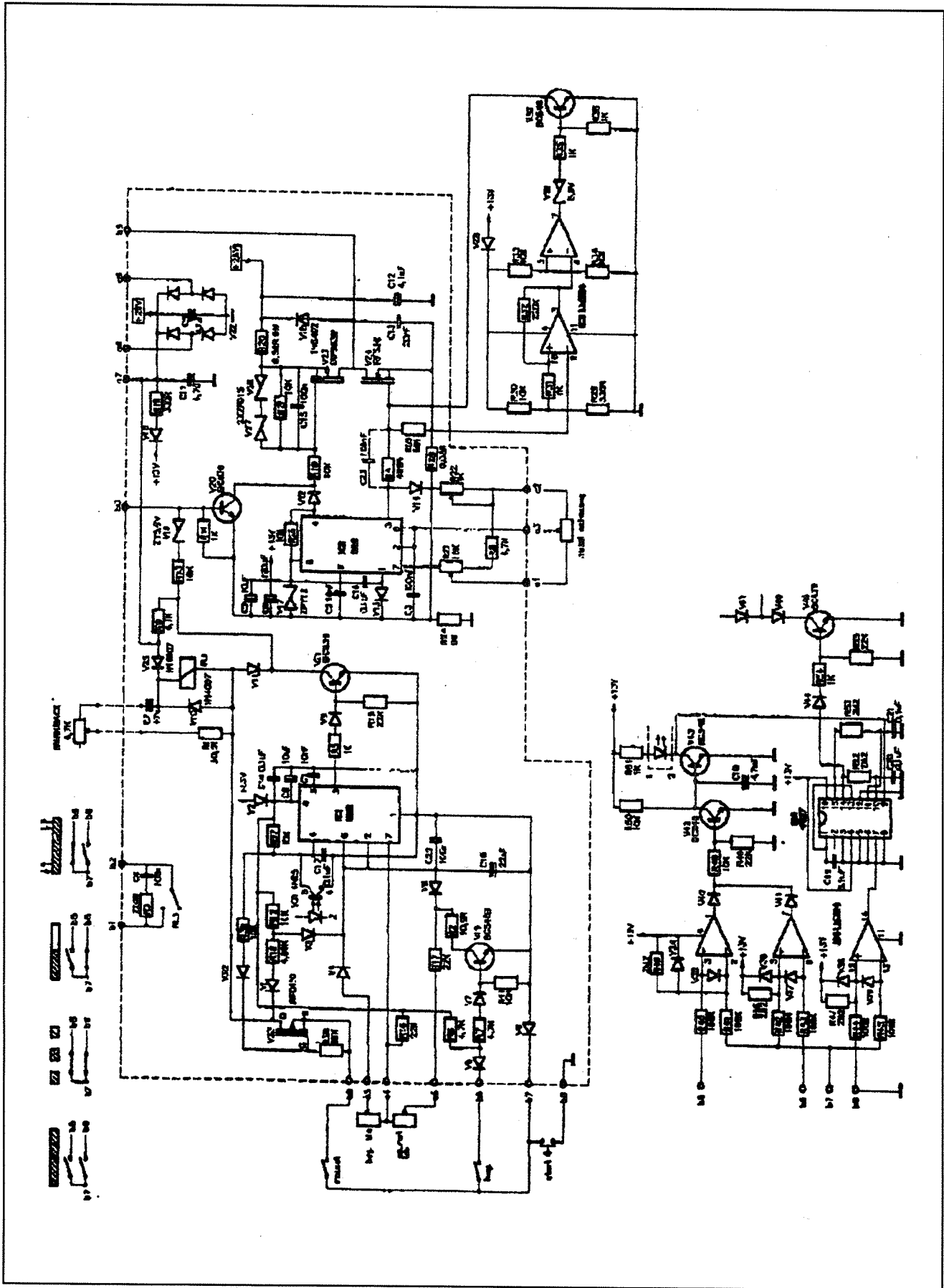

PCB WIRING DIAGRAM

### HTP MIG 120

Heat Settings	No Load Voltage	Amps	Wire Feed Rate	Amps	Wire Feed Rate
		.023" Wire		.030" Wire	
1	26.5	28	1 - 1 1/2	45	1
2	29.3	45	2 - 3	70	2
3	35.2	95	7 - 8	105	3
4	40.3	120	10	120	4

### HTP MIG 140

Heat Settings	No Load Voltage	Amps	Wire Feed Rate	Amps	Wire Feed Rate
		.023" Wire		.030" Wire	
1	23.1	25	1 - 1 1/2	45	1
2	25.3	45	2 - 3	70	2
3	27.9	60	7 - 8	105	3
4	31.2	75	10	120	4
5	35.2	90	3 3/4 - 4 3/4	100	3 1/4 - 4 1/4
6	40.3	120	8 - 10	140	4 1/2 - 5 1/2

### HTP MIG 160

Heat Settings	No Load Voltage	Amps	Wire Feed Rate	Amps	Wire Feed Rate
		.023" Wire		.030" Wire	
1	17.6	20	1 3/4 - 2 3/4	N/A	N/A
2	18.8	30	2 - 3	N/A	N/A
3	20.0	40	2 1/2 - 3 1/2	40	2 - 3
4	21.7	50	2 3/4 - 3 3/4	50	2 1/4 - 3 1/4
5	23.7	60	3 1/4 - 4 1/4	60	2 1/2 - 3 1/2
6	26.0	70	4 1/4 - 5 1/4	80	3 - 4
7	28.8	90	6 - 7	120	4 3/4 - 5 3/4
8	32.3	120	7 - 8	160	5 3/4 - 6 3/4



## HTP MIG 160DV

Heat Settings	No Load Voltage	Amps	Wire Feed Rate	Amps	Wire Feed Rate
		.023" Wire		.030" Wire	
1	17	20	1 1/4 - 2 1/4	N/A	N/A
2	18	30	1 1/2 - 2 1/2	N/A	N/A
3	19	40	1 3/4 - 2 3/4	40	1 1/2 - 2 1/2
4	21	55	2 1/4 - 3 1/4	60	1 3/4 - 2 3/4
5	22	65	2 3/4 - 3 3/4	78	2 - 3
6	25	90	4 - 5	95	2 3/4 - 3 3/4
7	28	100	6 3/4 - 7 3/4	130	4 1/4 - 5 1/2
8	31	140	9 to max.	160	6 - 7

## HTP MIG 200

Heat Settings	No Load Voltage	Amps	Wire Feed Rate	Amps	Wire Feed Rate
		.023" Wire		.030" Wire	
1,1	19.8	20	1 1/2 - 2 1/2	N/A	N/A
1,2	19.8	25	1 1/2 - 2 1/2	N/A	N/A
1,3	19.8	28	1 1/2 - 2 1/2	N/A	N/A
1,4	19.8	30	1 1/2 - 2 1/2	N/A	N/A
2,1	19.9	35	1 3/4 - 2 3/4	N/A	N/A
2,2	20.2	38	1 3/4 - 2 3/4	N/A	N/A
2,3	20.6	40	2 1/4 - 3 1/4	N/A	N/A
2,4	21.2	43	2 1/2 - 3 1/2	N/A	N/A
3,1	21.9	48	2 3/4 - 3 3/4	55	2 - 3
3,2	22.5	53	3 - 4	60	2 1/2 - 3 1/2
3,3	23.1	60	3 1/4 - 4 1/4	70	2 1/2 - 3 1/2
3,4	23.8	65	3 1/2 - 4 1/2	75	3 - 4
4,1	24.7	70	3 3/4 - 4 3/4	80	3 - 4
4,2	25.4	73	3 3/4 - 4 3/4	85	3 1/4 - 4 1/4
4,3	26.1	75	4 - 5	90	3 1/2 - 4 1/2
4,4	27.1	80	5 - 6	100	3 3/4 - 4 1/4
5,1	28.0	100	7 - 8	110	4 - 5
5,2	29.0	110	7 1/4 - 8 1/4	120	4 1/2 - 5 1/2
5,3	30.0	120	8 1/4 - 9 1/4	130	5 - 6
5,4	31.2	140	Max	145	7 - 8
6,1	32.5	N/A	N/A	155	7 1/2 - 8 1/2
6,2	33.8	N/A	N/A	170	8 - 9
6,3	35.3	N/A	N/A	180	9 - Max
6,4	36.8	N/A	N/A	200	Max

# HTP MIG 240

Heat Settings	No Load Voltage	Amps	Wire Feed Rate	Amps	Wire Feed Rate	Amps	Wire Feed Rate
		.023" Wire		.030" Wire		.035" Wire	
1,1	17.8	20	2 - 3	N/A	N/A	N/A	N/A
1,2	18.1	22	2 - 3	N/A	N/A	N/A	N/A
1,3	18.6	25	2 1/4 - 3 1/4	N/A	N/A	N/A	N/A
1,4	19.1	30	2 1/2 - 3 1/2	30	2 - 3	N/A	N/A
1,5	19.6	35	2 3/4 - 3 3/4	35	2 - 3	N/A	N/A
1,6	20.0	38	3 - 4	40	2 - 3	N/A	N/A
2,1	20.5	40	3 - 4	45	2 1/4 - 3 1/4	50	2 1/4 - 3 1/4
2,2	20.9	45	3 - 4	50	2 1/2 - 3 1/2	55	2 1/2 - 3 1/2
2,3	21.6	48	3 - 4	55	2 3/4 - 3 3/4	50	2 3/4 - 3 3/4
2,4	22.2	53	3 1/4 - 4 1/4	60	3 - 4	70	2 3/4 - 3 3/4
2,5	22.8	58	3 1/2 - 4 1/2	70	3 - 4	75	3 - 4
2,6	23.6	60	4 - 5	75	3 1/4 - 4 1/4	85	3 1/4 - 4 1/4
3,1	24.4	68	4 1/4 - 5 1/4	80	3 1/2 - 4 1/2	90	3 1/2 - 4 1/2
3,2	25.2	75	4 1/4 - 5 1/4	85	3 3/4 - 4 3/4	100	3 3/4 - 3 3/4
3,3	26.1	80	4 1/2 - 5 1/2	90	4 - 5	110	4 - 5
3,4	27.1	85	4 3/4 - 5 3/4	100	4 - 5	130	4 1/2 - 5 1/2
3,5	28.0	92	5 1/4 - 6 1/4	105	4 3/4 - 5 3/4	135	4 1/2 - 5 1/2
3,6	29.2	100	5 1/2 - 7 1/2	110	5 1/2 - 6 1/2	140	5 1/4 - 6 1/4
4,1	30.0	110	6 1/2 - 7 1/2	130	7 - 8	150	5 1/4 - 6 1/4
4,2	31.2	120	7 1/4 - 8 1/4	140	7 1/2 - 8 1/2	155	5 1/2 - 6 1/2
4,3	32.7	130	8 - 9	150	8 - 9	170	5 3/4 - 6 3/4
4,4	34.1	140	8 1/2 - 9 1/2	170	9 - Max	190	6 1/4 - 7 1/4
4,5	35.6	145	9 to max	180	9 - Max	210	7 1/2 - 8 1/2
4,6	37.4	160	Max	220	Max	240	9 - 10

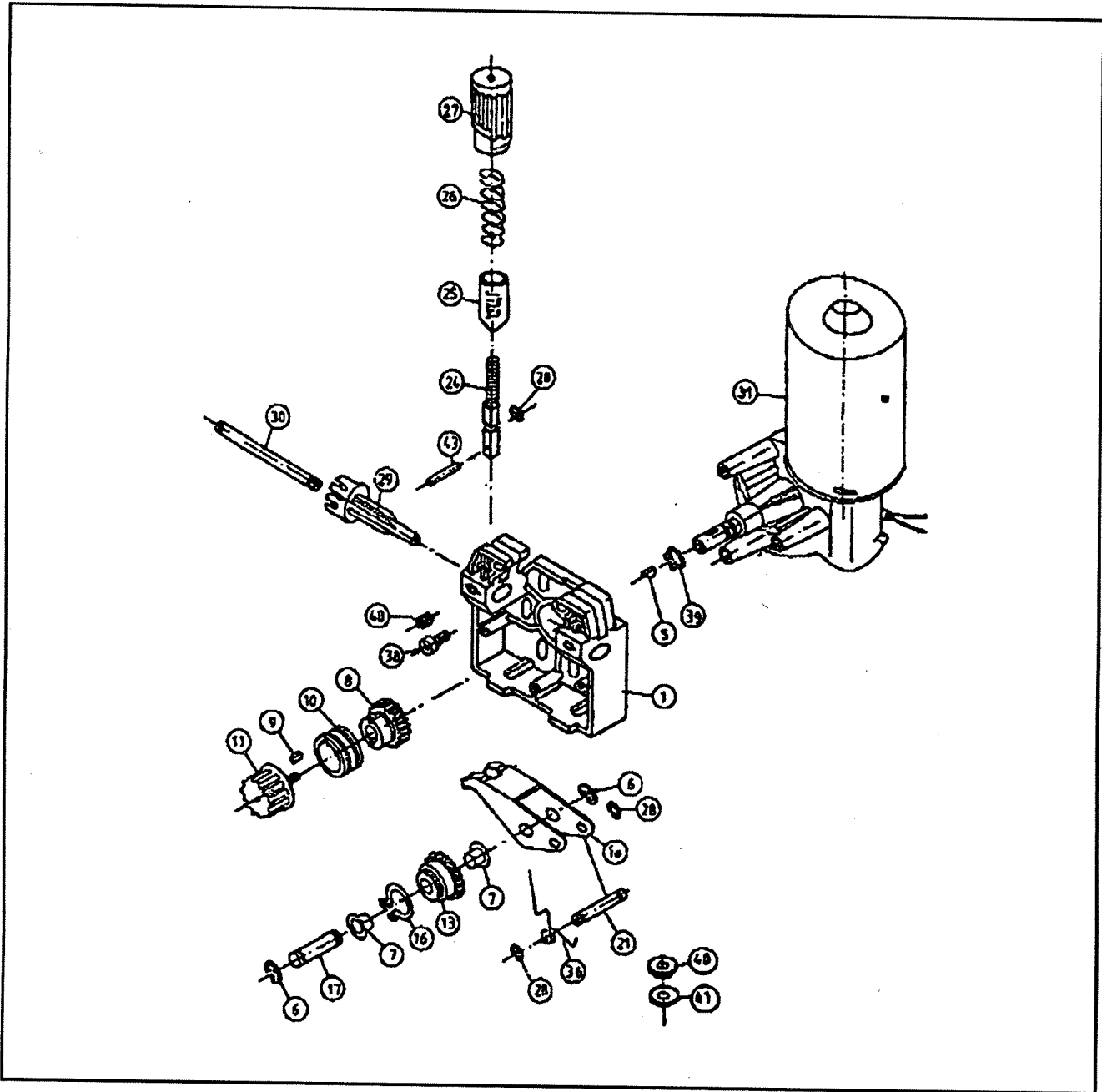

**TWO ROLL WIRE FEED MECHANISM**