

# INSTALLATION INSTRUCTIONS

READ IMPORTANT SAFETY TIPS BEFORE PROCEEDING WITH INSTALLATION

## SAFETY TIPS

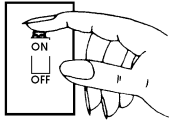

Turn fixture off! (Place wall switch in off position, if fixture has built-in switch or chain pull, switch or pull chain so fixture is off.)



Next - go to the main fuse box. If your fuse box has an ON/OFF switch, simply place main power switch in OFF position.

OR

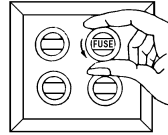

Screw-in type fuses - unscrew the fuse or fuses that control the power to the fixture or room you are working in.

1

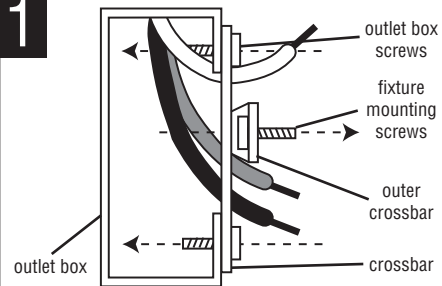

THREAD fixture mounting screws (provided) into outer crossbar.  
ATTACH cross bar to outlet box with outlet box screws (not provided).

2

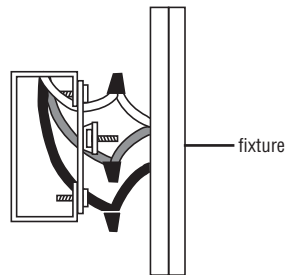

CONNECT THE WIRES. NOTE: Attach black fixture wire to black supply wire, white fixture wire to white supply wire and green fixture ground wire to ground wire in outlet box. NOTE: wire connectors not provided. NEVER CONNECT GREEN FIXTURE GROUND TO BLACK OR WHITE POWER SUPPLY LEADS.

3

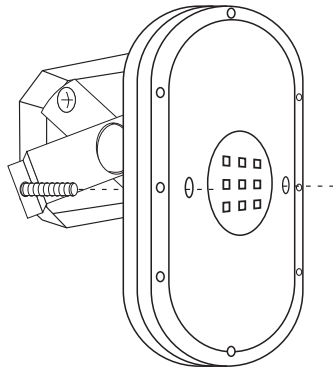

POSITION THE FIXTURE over the fixture screws and secure in place with thumb nuts (provided). Fixture may be mounted to ceiling or wall. The photo sensor or knock out must be orientated down when the fixture is mounted to a wall.

4

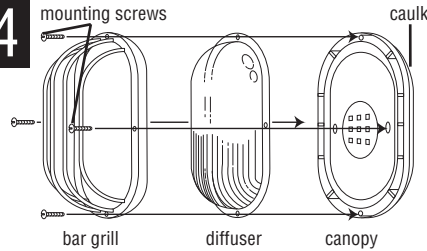

PLACE DIFFUSER ON CANOPY. Then place bar grill or frame over diffuser and attach to canopy with mounting screws (8-32x1/2, 4 combination head screws provided). NOTE: On models with hood, attach diffuser to base with one combination head mounting screw at center top of base only. Place hood over diffuser and secure to base with remaining three mounting screws.

NOTE: Outdoor fixtures (wall & ceiling) MUST be caulked with an acrylic caulk where the base of fixture meets the mounting surface. This provides a water tight seal when fixture is mounted.

This fixture may have an integral photo sensor that turns the fixture off during the day and on at night. The photo sensor is not adjustable. The fixture could possibly cycle on and off due to light reflected from nearby surfaces into the photo sensor. If cycling occurs, remove the photo sensor nut and install the swivel hood and base. The hood and base are adjustable. The hood can be rotated and the base can be cut along the dotted line to reduce overall length. Check operation before cutting the base.

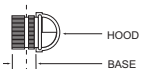

Clean only with mild soap and water. Avoid spraying with Cleaners, Insecticides, and Pesticides that a petroleum based hydrocarbon products. These will degrade Luminaire.



**CAUTION:** Do not turn on without diffuser installed. Do not touch LEDs or circuit board. LED optics could be damaged. Do not remove protective cover from light engine.

IS77WFLEOSE5

# INSTALLATION INSTRUCTIONS

READ IMPORTANT SAFETY TIPS BEFORE PROCEEDING WITH INSTALLATION

## SAFETY TIPS

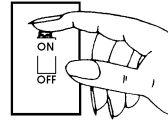

Turn fixture off! (Place wall switch in off position, if fixture has built-in switch or chain pull, switch or pull chain so fixture is off.)



Next - go to the main fuse box. If your fuse box has an ON/OFF switch, simply place main power switch in OFF position.

OR

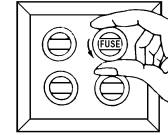

Screw-in type fuses - unscrew the fuse or fuses that control the power to the fixture or room you are working in.

1

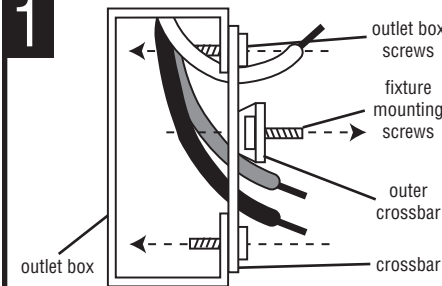

THREAD fixture mounting screws (provided) into outer crossbar.  
ATTACH cross bar to outlet box with outlet box screws (not provided).

2

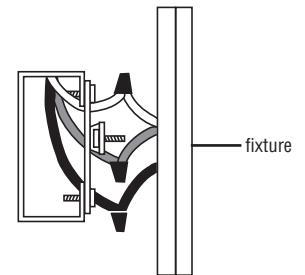

CONNECT THE WIRES. NOTE: Attach black fixture wire to black supply wire, white fixture wire to white supply wire and green fixture ground wire to ground wire in outlet box. NOTE: wire connectors not provided. NEVER CONNECT GREEN FIXTURE GROUND TO BLACK OR WHITE POWER SUPPLY LEADS.

3

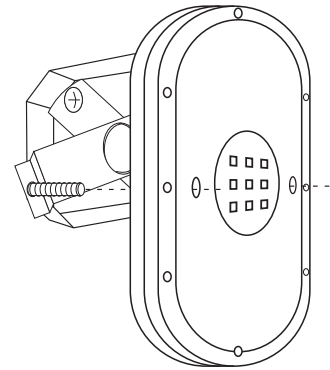

POSITION THE FIXTURE over the fixture screws and secure in place with thumb nuts (provided). Fixture may be mounted to ceiling or wall. The photo sensor or knock out must be orientated down when the fixture is mounted to a wall.

4

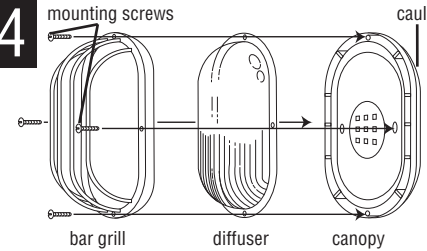

PLACE DIFFUSER ON CANOPY. Then place bar grill or frame over diffuser and attach to canopy with mounting screws (8-32x1/2, 4 combination head screws provided). NOTE: On models with hood, attach diffuser to base with one combination head mounting screw at center top of base only. Place hood over diffuser and secure to base with remaining three mounting screws.

NOTE: Outdoor fixtures (wall & ceiling) MUST be caulked with an acrylic caulk where the base of fixture meets the mounting surface. This provides a water tight seal when fixture is mounted.

This fixture may have an integral photo sensor that turns the fixture off during the day and on at night. The photo sensor is not adjustable. The fixture could possibly cycle on and off due to light reflected from nearby surfaces into the photo sensor. If cycling occurs, remove the photo sensor nut and install the swivel hood and base. The hood and base are adjustable. The hood can be rotated and the base can be cut along the dotted line to reduce overall length. Check operation before cutting the base.

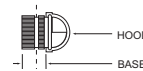

Clean only with mild soap and water. Avoid spraying with Cleaners, Insecticides, and Pesticides that a petroleum based hydrocarbon products. These will degrade Luminaire.



**CAUTION:** Do not turn on without diffuser installed. Do not touch LEDs or circuit board. LED optics could be damaged. Do not remove protective cover from light engine.

IS77WFLEOSE5