

CHLORIDE

by  Signify

INSTALLATION INSTRUCTIONS FOR EXIT SIGN AND EMERGENCY LIGHT COMBINATION

IMPORTANT SAFEGUARDS

READ AND FOLLOW ALL SAFETY INSTRUCTIONS

1. Review the diagrams thoroughly before beginning.
2. All electrical connections must be in accordance with local codes, ordinances, and the National Electric code.
3. Disconnect power at fuse or circuit breaker before installing or servicing.
4. Do not use outdoors.
5. Do not mount in hazardous locations, or near gas or electric heaters.
6. Do not let power cords touch hot surface.
7. Equipment should be mounted in locations and at heights where it will not be subjected to tampering by unauthorized personnel.
8. The use of accessory equipment not recommend by the manufacturer may cause an unsafe condition.
9. Do not use this equipment for other than intended use.
10. All servicing should be performed by a qualified personnel only.
11. Allow battery to charge for 24 hours before first use, for 2 batteries model, need 48 hours fully charge batteries.

SAVE THESE INSTRUCTIONS

Use Flexible Conduit Only

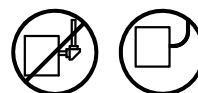

WIRING DIAGRAM (see Fig 1)

AC Wiring

Connect the J-box wires to the power supply wires using the wire nuts provided.
Connect the white wire to neutral.
If using 120V, connect the black wire to the hot lead.
If using 277V, connect the orange wire to the hot lead.
Cap the unused lead.

Fig 1

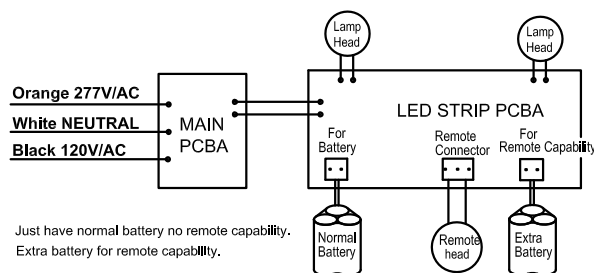

Assembly Lamp Heads (see Fig 2)

1. Open front cover by flat screwdriver.
2. Snap lamp head on the 2 corners of frame. if unit is ceiling mount or side mount, lamp head can assemble backward.
3. Attach 2 pcs lamp heads male and female connector together.

Fig 2

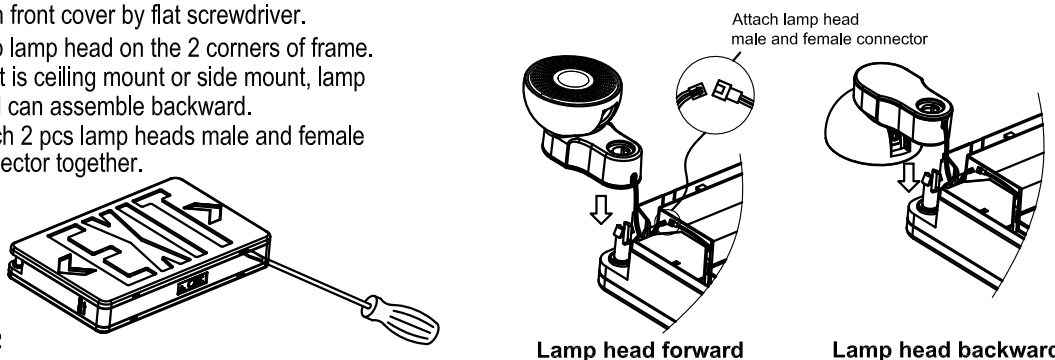

Wall Mounting (see Fig 3)

1. Open front cover and assemble 2 pcs lamp heads on the frame.
2. Knock out center and appropriate mounting screw holes on the back plate.
3. Route the proper wires through center hole out of housing .
4. Make electrical connections inside the J-Box as wiring diagram.
5. Push excess wire into J-Box, use screws tighten unit to J-Box.
6. Snap chevron to EXIT panel if required.
7. Attach battery connector to PC board, restore front panel on unit, adjust position of lamp heads as need.

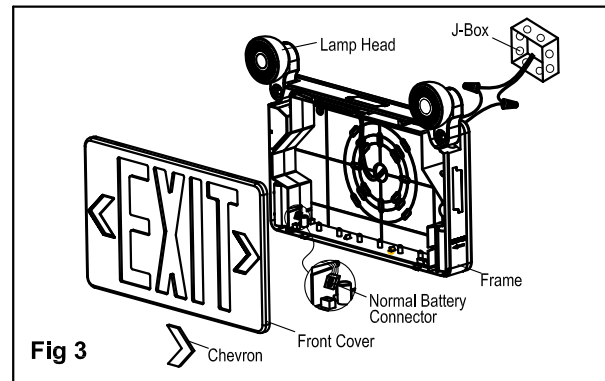

Side or Ceiling Mounting (see Fig 4, Fig 5)

1. Attach crossbar to junction box, set the crossbar so that the longer blade is touching the J-Box.
2. Open front cover and assemble 2 pcs lamp heads on the frame.
3. If double face is desired, replace back plate with additional face plate provided.
4. Remove out the mounting hole cover on the top or side of the unit, assemble the canopy (see Fig 6).
5. Route the proper wires through mounting hole out of housing .
6. Make electrical connections inside the J-Box as wiring diagram.
7. Push excess wire into J-Box, use screws tighten canopy to crossbar so that canopy is securely fastened and tight against the wall.
8. Snap chevron to EXIT panel if required.
9. Attach battery connector to PC board, restore front panel on unit, adjust position of lamp heads as need.

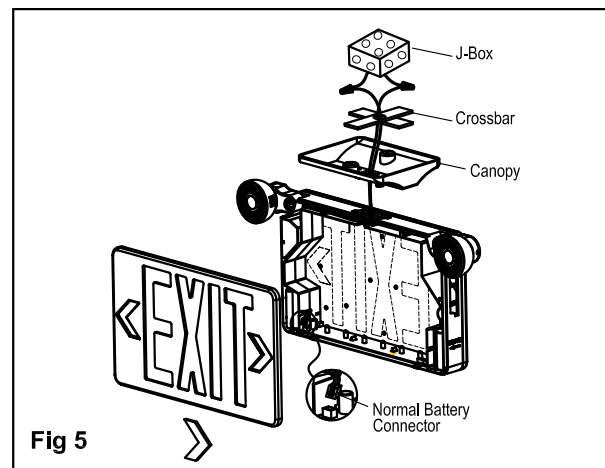
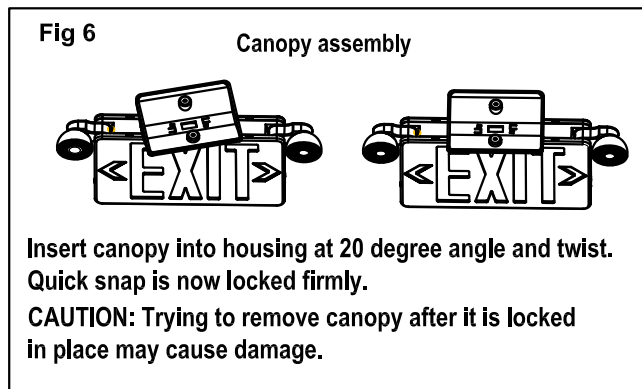
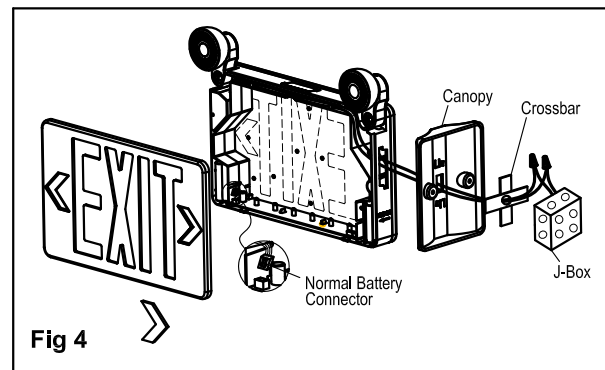

Connecting Remote heads (see Fig 7)

Using normal battery, no remote capability.
 Using extra battery with remote capability.
 Connect remote heads extension wire to remote wire, yellow is positive(+), purple is negative(-). connect wires using wire nuts.

Remote capability reference below:
 VLLC-2R has max. 3.6V 2W remote capabilities.

