

V310 VENICE SERIES

SPECIFICATIONS

GENERAL

The V310 Venice series is designed with traditional Italian styling. It shall be appointed with a cast aluminum 5" decorative pineapple finial and decorative volutes. It is the middle scale of the Venice series fixtures.

POST FITTER

The fitter or base shall be heavy wall cast aluminum. It shall have an inside diameter opening to fit a 3" diameter pole or tenon. When ordered with a Sternberg aluminum pole, the fitter shall be set screwed to the pole top or tenon.

BALLAST

The ballast shall be remote mounted in the base of the pole, pole shaft, arm or ballast box. The ballast box shall be heavy wall cast aluminum. The remote ballast shall be attached to the ballast box or pole to ensure high capacity heat sinking of ballast temperatures, keeping the ballast cooler and ensuring long life.

ELECTRICAL

Fixture shall be U.L. or E.T.L. listed in U.S. and Canada. H.I.D. ballasts shall be high power factor with lamp starting down to -30 degrees C. Medium base and mogul base porcelain sockets are 4KV rated. The ballast/socket assembly shall be pre-wired when ballast is located in the fitter. All compact fluorescent (PL) ballasts shall be instant start electronic with a starting temperature of down to 0 degrees F. They shall have a 4-pin socket to accept quad or triple tube lamps. Ballasts shall be DOE EISA compliant.

FIXTURE HOUSING

The fixture shall be 17 1/4" diameter and 35" tall. It shall be made of heavy wall cast aluminum and the lens panels shall be made of vandal resistant acrylic, available in clear (CA), white acrylic (WA) or clear seeded acrylic (CSA).

OPTICAL OPTIONS

Refractors shall be 6" diameter borosilicate glass with an I.E.S. Type 3 (RE3) or Type 5 (RE5) distribution. It shall be secured to the socket stem with 3/8" plated steel threaded pipe nipple and rest on a cast aluminum holder with anti-shock gasket. The refractor will be secured to cast holder with a quarter-turn internal aluminum twist ring for ease of maintenance.

The NIGHTSKY® OPTI-SHIELD® Louver Optic System (LO) shall be a multi-tier reflector with 7" diameter rings to produce an I.E.S. Cut-off Type 3 or 5 distribution. The Louver Optic System shall be made of highly specular anodized aluminum and shall come standard with medium base socket.

NIGHTSKY® STAR-SHIELD® Roof Optics distribution shall be delivered by multi-segmented roof mounted reflector systems which eliminate upright and provide cut-off. The reflector cavity shall be made of specular anodized aluminum. Roof Optics Type 2 (RO2), Type 3 (RO3) or Type 5 (RO5) horizontal are available for medium base lamps.

Frosted Glass Hurricane Chimney (FHC) is an optic option which adds an authentic touch and can be used with Roof Optics.

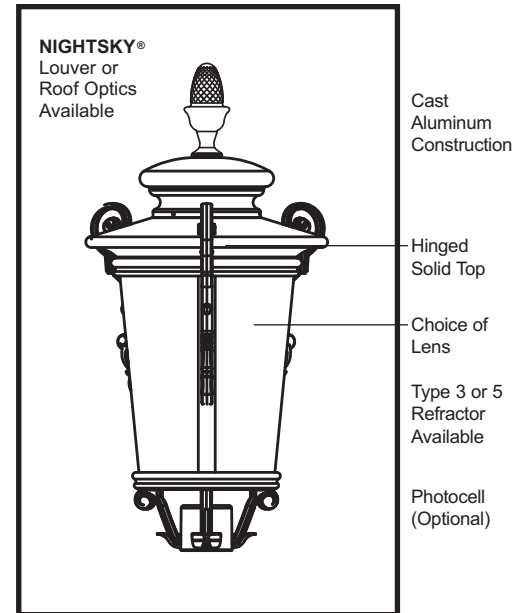

EPA = 1.69 (ft²)
WEIGHT = 33 LBS

V310 VENICE

FIXTURES / FITTERS / ARMS PM - WB

FIXTURES / OPTICAL SYSTEMS **HANGING**

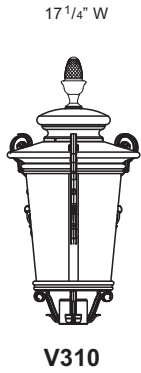

3L
3 Light



RE3
RE5
Refractor



FHC
Frosted
Chimney

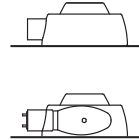

RO
Roof Optics
Horizontal
2, 3 or 5

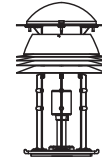

LO3
LO5
Louver Optics

SH
Stem
Hung

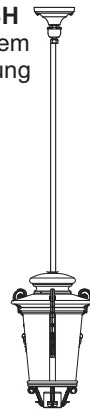

CH
Chain
Hung



ARMS - POST MOUNT (PM) or WALL BRACKETS (WB) See Arms Section for more information

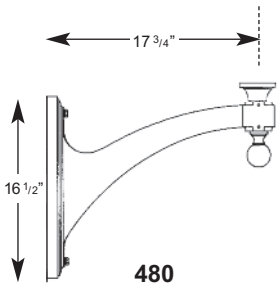

480

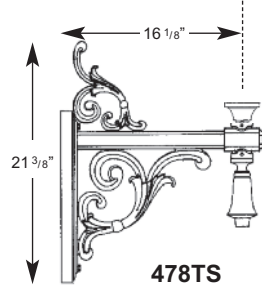

478TS

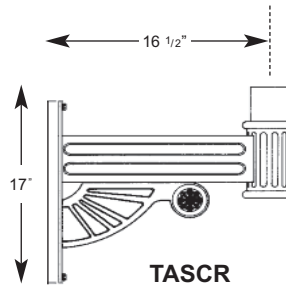

TASC

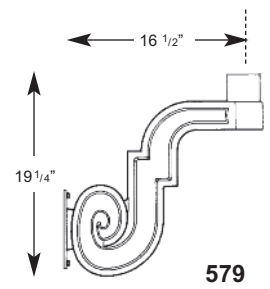

579

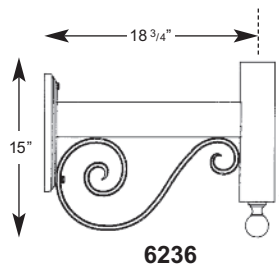

6236

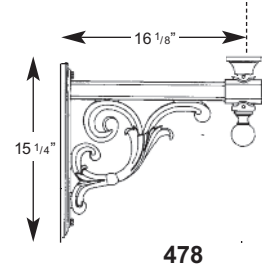

478

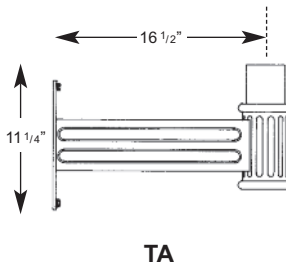

TA

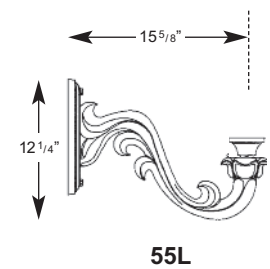

55L

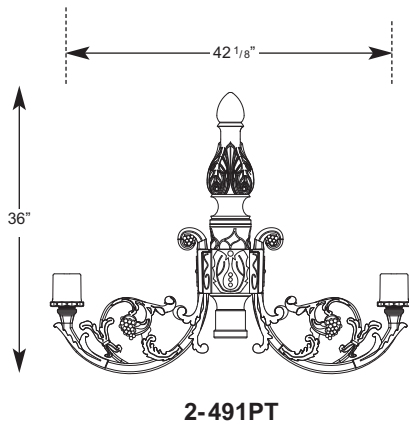

2-491PT

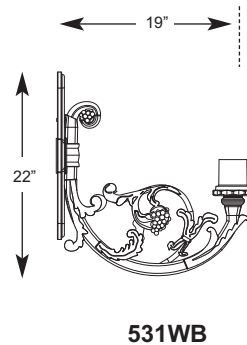

531WB

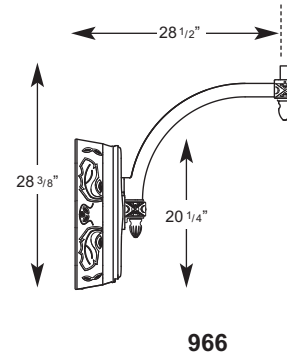

966

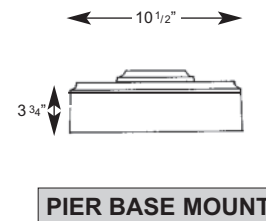

PIER BASE MOUNT

450PB

BUILDING A PART NUMBER

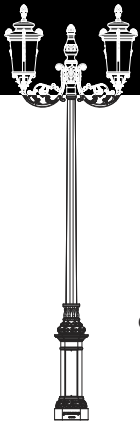

POST & ARM FIXTURES

ARM MOUNTED FIXTURE		CENTER POST TOP FIXTURE (PT)	POST	POST CAP	LIGHT SOURCE BALLAST	OPTICS	OPTIONS	LENS	FINISH
NO. OF ARMS	FIXTURE / POSTARM	FIXTURE	(See Post Section)		WATTS / TYPE / VOLTS				
2	V310/491PT	PT	1611TFP5		100HPS120	RO3		CA	BK



WALL FIXTURES

FIXTURE / WALLBRACKET	LIGHT SOURCE BALLAST	OPTICS	OPTIONS	LENS	FINISH
WATTS / TYPE / VOLTS					
V310/531WB	100 HPS120	RE5		CA	BK



PIER FIXTURES
Uses same information boxes as wall fixture

V310/450PB

FIXTURE / FITTER / PIER BASE

PART NUMBER SELECTIONS

FIXTURES

- V310

OPTICS

- RE3
- RE5
- HSS
- LO3
- LO5
- RO2^{4,6}
- RO3^{4,6}
- RO5^{4,6}
- FHC²
- 3L

LENSES

- CA
- WA
- CSA

OPTIONS

- PEC Photocell-Electronic 120-277 Volt
- FHS Single Fuse and Holder-120,277 Volt
- FHD Dual Fuse and Holder-208,240,480 Volt
- QR Quartz Re-Strike
- PF Pineapple Finial or Font (TA,TASCR)
- BF Ball Finial or Font (TA,TASCR)
- 3L 3 Light Cluster
- FHC Frosted Chimney
- LAMPS Select from List

POST ARMS

- 55LPM
- 478PM
- 478TSPM
- 480PM
- 491PT
- 579PT
- 6236PM
- TAPT
- TASCRPT

VOLTAGES

- 120
- 208
- 240
- 277
- 480
- MULTI (120-277)

WALL BRACKET ARMS

- 55LWB
- 531WB
- 579WB
- 478WB
- 478TSWB
- 480WB
- 480DWB
- 966WB
- 6236WB
- TAWB
- TASCRWB

PIER MOUNT

- 450PB

BALLASTS^{3,6}

- 35HPS¹
- 50HPS
- 70HPS
- 100HPS
- 150HPS
- 50MHP
- 70MHP
- 100MHP
- 150MHP

LAMPS⁶

- HPS35/MED
- HPS50/MED
- HPS70/MED
- HPS100/MED
- HPS150/MED
- MHP50/MED
- MHP70/MED
- MHP100/MED
- MHP150/MED

STANDARD FINISHES*

- BKT Black Textured
- WHT White Textured
- PGT Park Green Textured
- ABZT Architectural Medium Bronze Textured
- DBT Dark Bronze Textured

*Smooth Finishes are available upon request

CUSTOM FINISHES

- OI Old Iron
- RT Rust
- WBR Weathered Brown
- CD Cedar
- WBK Weathered Black
- TT Two Tone

STERNBERG SELECT FINISHES

- VG Verde Green
- SI Swedish Iron
- OWGT Old World Gray Textured

NOTES:

- ¹ 35HPS is 120 volt only.
- ² MED base only when used to house lamp.
- ³ Medium base sockets standard with HID ballasts up to 150 watts.
- ⁴ Medium base lamp only. Consult factory for mogul base.
- ⁵ Can support PLT up to 120 watts.
- ⁶ Metal halide systems are pulse start.

V310 VENICE SERIES

SPECIFICATIONS

**LIST NO.
V310 VENICE
SERIES**

QUARTZ RE-STRIKE

The V310 fixture can be supplied with an optional quartz re-strike system to retain constant fixture light if the H.I.D. lamp fails. The fixture will be equipped with a 100 watt quartz lamp and a controller to run on a 120 volt circuit and must be used in conjunction with a 120 volt or multi-tap ballast.

PHOTOCELLS

Photocells shall be the electronic button type. On single post top fixtures the photocell shall be mounted in the fitter and pre-wired to ballast. On multiple head fixture assemblies photocells shall be mounted in the pole shaft on an access plate and are not pre-wired as ballast housing assemblies and fitters are packaged separately for ease of wiring to source. The electronic button type photocell is instant on and a 5-10 second turn off and shall turn on at 1.5 footcandles with a turn-off at 2-3 footcandles. Photocells are 120-277 volt.

ARMS

All arms are made of cast aluminum and/or extruded aluminum. Arms with decorative filigree have meticulously detailed scroll work and gracefully curved brackets. All V310 fixtures will be mechanically attached to the arm at the factory to ensure arms will be plumb, secure and level over the life of the installation. Each arm shall be bolted to a post mount adapter, which is welded to the pole to ensure proper alignment to the base. Twin TA, TASCRA and 579 arms will be attached to a decorative center hub which will slip-fit the center tenon of the pole (not shown). BA and 779 arms are available as a twin application. Arms are pre-wired for ease of installation.

FINISH

Prior to coating, each assembly shall be chemically cleaned and etched in a 5-stage washing system which includes alkaline cleaning, rinsing, phosphoric etching, reverse osmosis water rinsing and non-chrome sealing to ensure corrosion resistance and excellent adhesion for the finish coating. The finish coating shall be electrostatically applied semi-gloss, super durable polyester powder baked at 400 degrees for a durable and superior, color retentive finish. Our optional antique Verde Green finish and Swedish Iron finish are hand brushed using a 3-step process. The total assembly shall be wrapped in shockproof wrapping or fully enclosed in corrugated cartons.

WARRANTY

Five-year limited warranty. See product and finish warranty guide for details.

