



A840-VCOB OLD TOWN SERIES

LED

EPA
1.06 (ft²)
WEIGHT
22 LBS

7 YEAR
WARRANTY

LUMEN
RANGE
3,930 to
7,710

LIFE SPAN
L70
MINIMUM
100,000
HOURS

UL
LISTED

CLICK
FOR FAQ'S

JOB NAME _____

FIXTURE TYPE _____

MEMO _____

BUILD A PART NUMBER

ORDERING EXAMPLE: **PT-A840-5P-VCOB-4L40TS-MDLO3-A-PEC-FHD/4212FP4-188/BKT**

Mounting Config.	Fixture	Fitter	LED	CCT	Distribution Type	Driver	Lens	Option Control Receptacle	Option Control	Option Fuse	Option Decorative Ring	Option GFI	Option Terminal Block	Option House Side Shield	Arm See Arm Spec Sheets	Pole See Pole Spec Sheets	Finish

Mounting Configuration

(Click here to link to mounting configuration specification page)

- 1W
- 2A
- 3A90
- 1AM
- PT
- 2A90
- 3APT
- 2AM
- 1A
- 2APT
- 4A
- 450PB
- 1APT
- 3A
- 4APT

W = Wall Mount PT = Post Top A = Arm Mount AM = Arm Mid-Mount PB = Pier Base

Fixture

- A840
- A840SR

Fitter

- 5P¹
- 99¹
- 995¹
- OL3
- 73
- 992¹
- BD4
- OL4
- 74
- 993¹
- BD5
- 588
- 990¹
- 994¹
- BD7
- C2097^{1,2}

¹ Add "T" after fitter designation for optional "Twist-lock" fitter.
² Consult factory for use on concrete poles.

LED

- VCOB-4L

CCT - Color Temperature (K)

- 27(00)
- 30(00)
- 35(00)
- 40(00)
- 50(00)

Distribution Type

- TS (Symmetric)
- TA (Asymmetric)

Driver

- MDLO2 (120V-277V, 250mA)
- MDLO3 (120V-277V, 350mA)
- MDLO5 (120V-277V, 500mA)
- MDHO2 (347V-480V, 250mA)
- MDHO3 (347V-480V, 350mA)
- MDHO5 (347V-480V, 500mA)

Lens

- A (Textured Acrylic)
- P (Textured Poly)
- WA (White Textured Acrylic)
- WP (White Textured Poly)

Options (Click here to view accessories sheet)

- R³ 3-Pin control receptacle only
- R5³ 5-Pin control receptacle only
- R7³ 7-Pin control receptacle only

- PE⁴ Twist-Lock Photocontrol (120v-277v)
- PE3⁴ Twist-Lock Photocontrol (347v)
- PE4⁴ Twist-Lock Photocontrol (480v)
- SC⁴ Shorting Cap
- PEC Electronic Button Photocontrol (120v-277v)
- PEC4 Electronic Button Photocontrol (480v)
- FHD⁵ Double Fuse and Holder
- PBDR⁶ Perforated Brass Decorative Ring
- GFI³ 15A Duplex GFI for Utility Fitter
- TB³ Terminal Block
- HSS 120° House Side Shield

³ For 900 series utility fitter only.
⁴ Requires control receptacle.
⁵ Ships loose for installation in base.
⁶ Standard is polished, for painted ring specify PBDR-P.
⁷ For use with "TA" distribution type only.

Arm (Click here to link to arm specification page)

See Arms & Wall Brackets specification sheets.
•78 •55 •579 •80 •6236 •TASCR

Pole (Click here to link to pole specification page)

See Pole specification sheets.

Finish (Click here to view paint finish sheet)

Standard Finishes⁸

- BKT Black Textured
- WHT White Textured
- PGT Park Green Textured
- ABZT Architectural Medium Bronze Textured
- DBT Dark Bronze Textured

⁸ Smooth finishes are available upon request

Custom Finishes⁹

- OI Old Iron
- RT Rust
- WBR Weathered Brown
- CD Cedar
- WBK Weathered Black
- TT Two Tone

⁹ Custom colors require upcharge.

Sternberg Select Finishes

- VG Verde Green
- SI Swedish Iron
- OWGT Old World Gray Textured

Specifications

Fixture

The fixture shall be 14-1/4" in diameter and 37-3/4" tall. Acorn will be made of vandal resistant clear textured polycarbonate or dent resistant (DR) clear textured acrylic. White textured is also available. The fixture is available in a solid roof (A840SR) for added distinction and reduced up-light. The solid roof will be made of spun aluminum and securely affixed to the top of the acorn. The optional perforated brass decorative ring (PBDR) is available in polished brass or painted finish. The 2-1/4" wide brass fligree allows light transfer through the decorative openings. The Luminaire shall be UL listed in US and Canada.

Fitter - Standard

The fitter shall be heavy wall cast aluminum, 356 alloy for high tensile strength. It shall have an 8-1/2" inside diameter opening to attach to the 8" neck of the acorn globe. When ordered with a Sternberg aluminum pole, the fitter shall be welded to the pole top or tenon for safety and to ensure the fixture will be plumb, secure and level over the life of the installation. The fitter shall have a one-piece ring bug gasket to resist insect penetration into lamp assembly.

900 Series Utility Fitter Option

The fitter shall be heavy wall cast aluminum, 360 die cast alloy for high tensile strength. It shall have a 9-1/4" inside diameter opening to attach to the 8" neck of the acorn globe. It shall have a hinged, tool-less entry door that provides open access to all of the components. The 900 series shall have an optional terminal block for ease of wiring, an optional Twist-Lock Photocontrol receptacle, an optional single GFCI outlet for auxiliary power needs. The top mounted driver mounting plate shall be cast aluminum and provide tool-less removal from the housing using 2 finger latches. The fitter shall have a one-piece ring gasket to resist insect penetration into globe assembly. When supplied with GFCI receptacle a hole will be provided for cord and plug installation with the access door closed. When cord and plug is not

See next page

A840-VCOB OLD TOWN SERIES

LED

in use a filler plug will be provided and shall be tethered to the fitter for easy recovery and installation.

Twist-Lock Fitter (Optional)

The TL (Twist-Lock) fitter shall have an aluminum die-cast twist-lock mechanism. The tool-less 1/4 turn action allows for easy globe removal and replacement. A die-cast ring assembly is mechanically attached to the globe and is removable if the globe is broken or replaced.

LED's

The luminaire shall use high output, high brightness LED's, consisting of a two piece assembly complete with Chip on Board (COB) LED component and COB holder frame mounted to vertical heat sinks. The LED's and printed circuit boards shall be 100% recyclable; they shall also be protected from moisture and corrosion by a conformal coating. They shall not contain lead, mercury or any other hazardous substances and shall be RoHS compliant. The LED life rating data shall be determined in accordance with IESNA LM-80. The High Performance white LED's will have a life expectancy of approximately 100,000 hours with not less than 70% of original brightness (lumen maintenance), rated at 25°C. The High Brightness, High Output LED's shall be 4000K (2700K, 3000K, 3500K or 5000K option) color temperature with a minimum CRI of 70. Consult factory for custom color CCT. The luminaire shall have a minimum _____ (see

table) delivered initial lumen rating when operated at steady state with an average ambient temperature of 25°C (77°F).

Optics

The luminaire shall be provided with individual, molded silicone refractor type optics applied to each COB (Chip On Board) LED assembly. The optic shall be at least 92% efficient while providing superior thermal, UV and impact resistance for the COB assembly. The optic helps efficiently shape and distribute the light while minimizing up-light. The luminaire shall provide Symmetric and Asymmetric light distribution. Testing shall be done in accordance with IESNA LM-79.

Electronic Drivers

The LED driver shall be U.L. Recognized. It shall be securely mounted inside the fixture, for optimized performance and longevity. It shall be supplied with a quick-disconnect electrical connector on the power supply, providing easy power connections and fixture installation. It shall have overload, overheat and short circuit protection, and have a DC voltage output, constant current design, 50/60HZ. It shall be supplied with line-ground, line-neutral and neutral-ground electrical surge protection in accordance with IEEE/ANSI C62.41.2 guidelines. It shall be a high efficiency driver with a THD less than 20% and a high power factor greater than .9. It shall be dimming capable using a 0-10v signal, consult factory for more information.

Photocontrols

Button Style: The photocontrol shall be mounted on the fixture and pre-wired to driver. The electronic button type photocontrol is instant on with a 5-10 second turn off, and shall turn on at 1.5 footcandles with a turn-off at 2-3 footcandles. Photocontrol is 120-277 volt and warranted for 6 years. See pole spec sheet for pole mounted version.

Twist-Lock Style: The photocontrol shall be mounted in the utility fitter and pre-wired to driver. The twist lock type photocontrol is instant on with a 3-6 second turn off, and shall turn on at 1.5 footcandles with a turn-off at 2-3 footcandles. Photocontrol is 120-277 volt and warranted for 6 years.

Warranty

Seven-year limited warranty. See product and finish warranty guide for details.

Finish

Refer to website for details.

Performance

LIGHT SOURCE	TS INITIAL LUMENS	EFFICACY (LPW)	TA INITIAL LUMENS	EFFICACY (LPW)	WATTAGE
4L40T_-MDL05	7710	102.8	7595	101.3	75
4L30T_-MDL05	7470	99.6	7355	98.1	75
4L27T_-MDL05	6790	90.5	6685	89.1	75
4L40T_-MDL03	6050	108.0	5980	106.8	56
4L30T_-MDL03	5860	104.6	5790	103.4	56
4L27T_-MDL03	5325	95.1	5265	94.0	56
4L40T_-MDL02	4465	111.6	4445	111.1	40
4L30T_-MDL02	4325	108.1	4305	107.6	40
4L27T_-MDL02	3930	98.3	3915	97.9	40

Fixtures

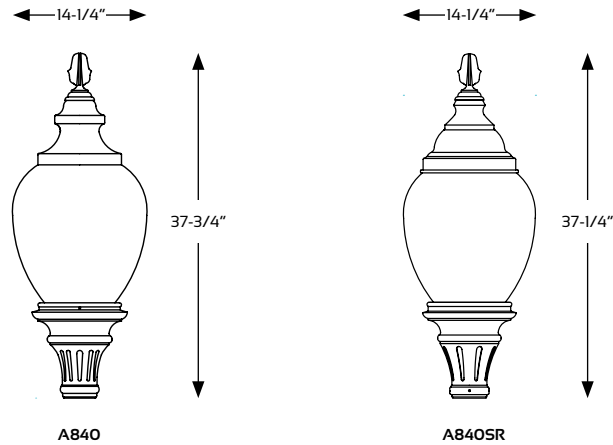

Fitters

10-1/8" W
10-3/8" H



5P or 5T*
Fits 3" OD
x 3" tall
tenon/pole

10-1/8" W
10-1/8" H

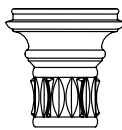

BD4
Fits 4" OD
x 5" tall
tenon/pole

10-1/8" W
10-1/4" H

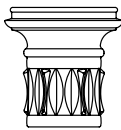

BD5
Fits 5" OD
x 6" tall
tenon/pole

10-1/8" W
11-3/4" H



BD7
Fits 7" OD
x 1" tall
tenon/pole

9-3/4" W
13-1/4" H

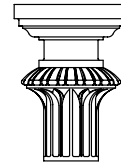

73
Fits 3" OD
x 4" tall
tenon/pole
74
Fits 4" OD
x 4" tall
tenon/pole

14-1/2" W
14-1/4" H

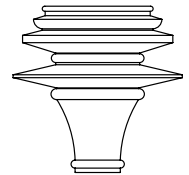

**588
(Art Deco I)**
Fits 3" OD
x 3" tall
tenon/pole

10-1/2" W
15-3/4" H



990 or 990T*
Fits 3" OD
x 3" tall
tenon/pole
994 or 994T*
Fits 4" OD
x 3" tall
tenon/pole

10-1/2" W
13-1/8" H

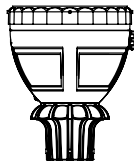

991 or 991T*
Fits 3" OD
x 3" tall
tenon/pole

10-1/2" W
13-1/8" H

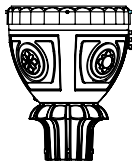

992 or 992T*
Fits 3" OD
x 3" tall
tenon/pole

10-1/2" W
15-3/4" H

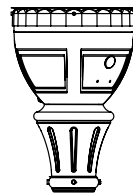

993 or 993T*
Fits 3" OD
x 3" tall
tenon/pole
995 or 995T*
Fits 4" OD
x 3" tall
tenon/pole

10-1/2" W
11-3/8" H



OL3
Fits 3" OD
x 3" tall
tenon/pole
OL4
Fits 4" OD
x 3" tall
tenon/pole

10" W
3-1/4" H



**C2097 or
C2097T***
Fits 7" OD
x 1" tall
tenon/pole

*Twist Lock Acorn (Fitter TL)