

66BU HERITAGE RESIDENTIAL SERIES

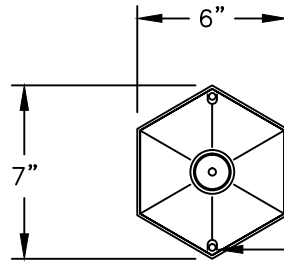
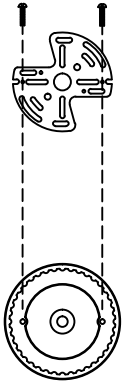

ALL ELECTRICAL COMPONENTS ARE U.L. OR E.T.L. LISTED IN USA AND CANADA.

FIXTURE WILL BE PREWIRED AND TESTED.

ROOF SECURED WITH (2) 10-24 X 1/2" KNURLED THUMB SCREWS

1/8" BRASS CAP NUT USED TO TIGHTEN DOWN ARM TO THE MOUNTING PLATE IN THE JUNCTION BOX

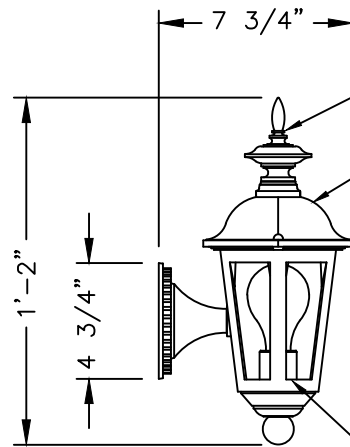

CAST ALUMINUM FINIAL

CAST ALUMINUM ROOF

(6) SIDED LENS AVAILABLE IN CLEAR SEEDED, CLEAR TEXTURED, CLEAR ACRYLIC, WHITE ACRYLIC OR BEVELED GLASS

MEDIUM BASE SOCKET, AVAILABLE WITH COMPACT FLUORESCENT

FIXTURE BLACKPLATE

SCREWS INCLUDED WITH JUNCTION BOX

1/8" X 2" BRASS NIPPLE

MOUNTING PLATE ATTACHES TO JUNCTION BOX

EXTERIOR WALL

JUNCTION BOX IN WALL NOT SUPPLIED

STERNBERG

SINCE 1923

66BU

3/16"=1'

DRAWN LMG
DRAWN DATE
SEPT 28 2011
DRAWING NUMBER

66LF HERITAGE RESIDENTIAL SERIES

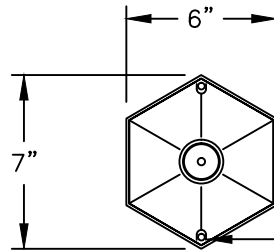
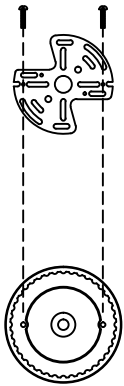

ALL ELECTRICAL COMPONENTS ARE U.L. OR E.T.L. LISTED IN USA AND CANADA.

FIXTURE WILL BE PREWIRED AND TESTED.

ROOF SECURED WITH (2) 10-24 X 1/2" KNURLED THUMB SCREWS

1/8" BRASS CAP NUT USED TO TIGHTEN DOWN ARM TO THE MOUNTING PLATE IN THE JUNCTION BOX

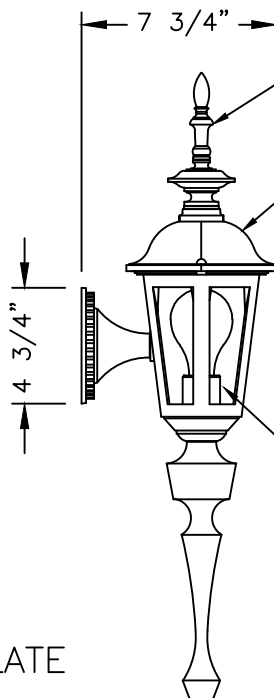
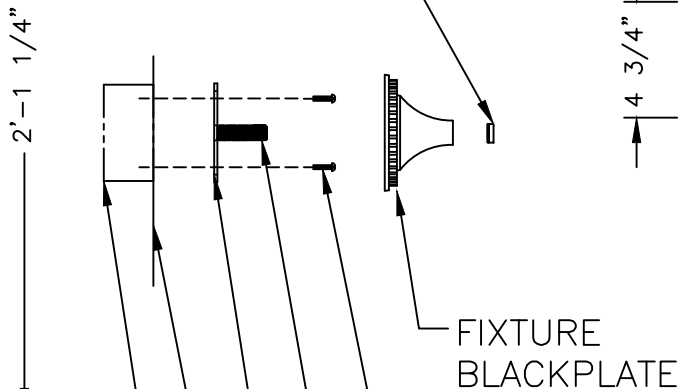

CAST ALUMINUM FINIAL WITH BRASS PACKAGE

CAST ALUMINUM ROOF

(6) SIDED LENS AVAILABLE IN CLEAR SEEDED, CLEAR TEXTURED, CLEAR ACRYLIC, WHITE ACRYLIC OR BEVELED GLASS

MEDIUM BASE SOCKET, AVAILABLE WITH COMPACT FLUORESCENT

SCREWS INCLUDED WITH JUNCTION BOX

1/8" X 2" BRASS NIPPLE

MOUNTING PLATE ATTACHES TO JUNCTION BOX

EXTERIOR WALL

JUNCTION BOX IN WALL NOT SUPPLIED



66LF

3/16"=1'

DRAWN LMG
 DRAWN DATE SEPT 28 2011
 DRAWING NUMBER