



Installation Instructions	Product: Fixture Mounting Hardware
Effective Date: March 29, 2016	Part Description: Hang Straight Horizontal Fitter Box

	WARNING: To avoid fire, shock or death, turn off and lockout power before performing any maintenance.
	CAUTION: This Fixture must be wired in accordance with the National Electric Code (NEC) and all applicable local codes. Proper grounding is required. A qualified electrician must do all work.

A. Install Hang Straight Horizontal Fitter Box and Fixture	
	Step 1: Loosen but do not remove the (3) 1/4-20 Set Screws in Cap.
	Step 2: Remove the Cap from Hang Straight Fitter Box. If supplied with a Finial or Photocell do not remove them from the Cap. Disconnect Photocell from fixture if applicable.
	Step 3: Remove and retain the 3/8-16 X 1-1/4" Hang Straight Safety Bolt with 3/8" Hex Lock Nut.
	Step 4: Remove and retain the (2) 3/8-16 Socket Head Set Screws in the Hang Straight Fitter Box.
	Step 5: Remove and retain the (3) 3/8-16 Set Screws from the Hang Straight Bolt housing.
	Note: The 3/8-16 X 1-1/4" Hang Straight Safety Bolt is MANDATORY. It must be installed properly into Arm to ensure safety.
	
	Step 6: Fully engage the Hang Straight Fitter Box with Fixture onto the Arm.
	Step 7: Using a Bubble Level on the top of Hang Straight where the Cap attaches, position the Hang Straight Fitter Box so that it is level.
	Step 8: Position Power Supply Lines away from the Hang Straight Safety Bolt hole.
	Step 9: Going through the single 3/8-16 tapped hole on the side of Hang Straight Fitter Box carefully drill a 1/4" hole in the Arm. Do not damage the 3/8-16 threads or Power Supply Lines.
	NOTE: Schedule time accordingly for this step, as drilling a 1/4" hole may take a few minutes.
	Step 10: Apply Loctite® Red Threadlocker or equivalent to the threads and install the 3/8-16 X 1-1/4" Hang Straight Safety Bolt with 3/8" Hex Lock Nut fully against the bolt head into the tapped hole on the side.
	Step 11: Tighten by hand making sure the Plunger on the end of the Hang Straight Safety Bolt engages the 1/4" hole in the Arm.
	Step 12: Re-level the Hang Straight Fitter Box if necessary.
	Step 13: Apply Loctite® Red Threadlocker or equivalent, insert and fully tighten the (2) 3/8-16 Set Screws on Hang Straight Fitter Box body.
	Step 13: Fully tighten the 3/8-16 Hang Straight Safety Bolt.
	Step 14: Apply Loctite® Red Threadlocker or equivalent on Hang Straight Safety Bolt and fully tighten the 3/8 Hex Nut against the Hang Straight Fitter Box body to lock the Safety Bolt in position.

	Step 15: Level the Fixture.
	Step 16: Apply Loctite® Red Threadlocker or equivalent, insert and tighten the (3) 3/8-16 Set Screws into the Hang Straight Bolt.
	Step 17: Reconnect Photocell if applicable. Replace Cap and tighten the (3) 1/4-20 Set Screws into the Hang Straight Fitter Box.

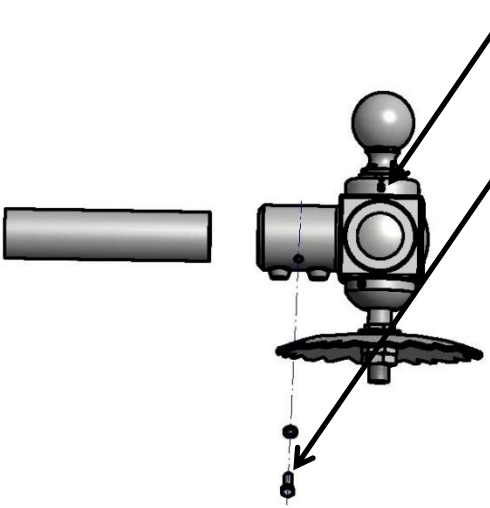
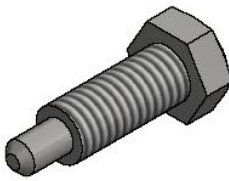
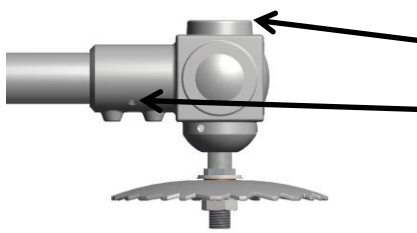
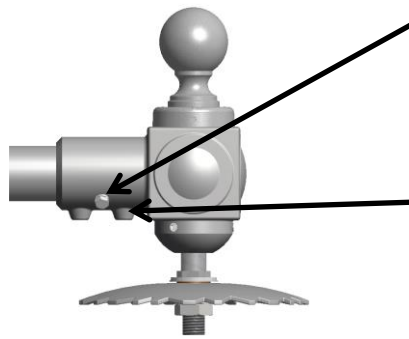
B. During Regular Maintenance	
	Step 1: Check to ensure fixture is still level and adjust if needed.
	Step 2: Check to ensure all mounting hardware is still tight. Remove any loose hardware and apply Loctite® Red Threadlocker or equivalent and re-install.
	Step 3: Fully tighten all mounting hardware if needed.

C. Optional Photocell Wiring Schematic Diagram (3-Pin Receptacle)

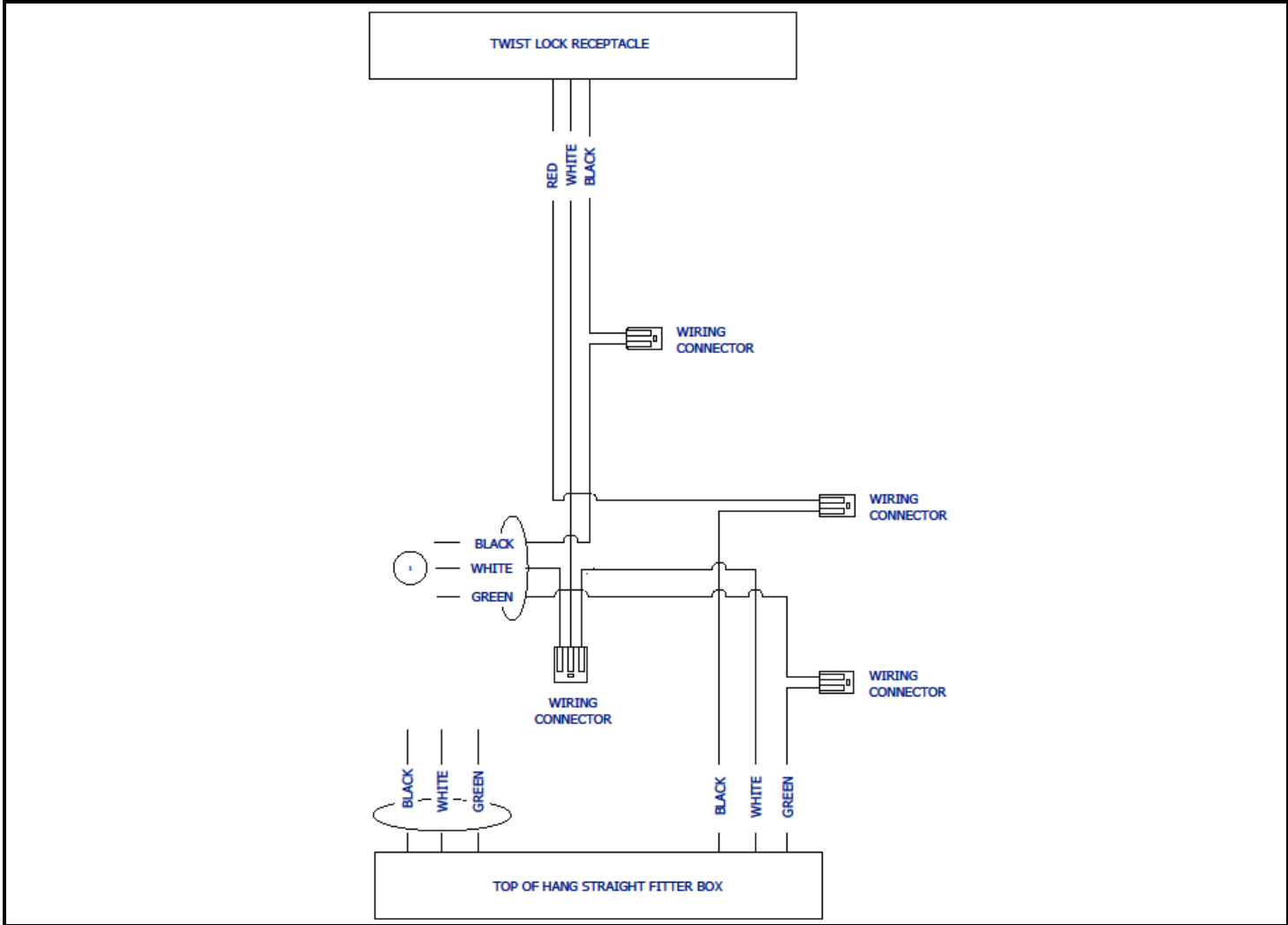

Revision History				
Rev	Description of Revision	Release Date	Manufacturing Engineer Author	Design Engineer Approval
A	Create Hang Straight Installation Instructions	03-29-2016	Grant Burton	John Wandrey
B	Added Hang Straight Safety Bolt	09-12-2016	Grant Burton	John Wandrey
C	Added Loctite® Red Threadlocker or equivalent to Hardware	02-14-2018	Grant Burton	John Wandrey