

## DESCRIPTION

The Shaper 1400 is a series of small decorative pendants designed for use in architectural, hospitality, and commercial space applications. The Shaper 1400 series uses performance optics providing high lumen outputs with low surface brightness. Available in one light level, five color temperatures, 90 CRI, and one optic distribution. Ten standard RAL paint finishes are available and can be selected for the shade or trim, as well as two metal finishes. Mounting options include fourteen field cuttable decorative power cords, or rigid stem options. The Shaper 1400 decorative pendant is a fun comprehensive solution where aesthetics and performance are well balanced.

## SPECIFICATION FEATURES

### Construction

The decorative shroud and trim, covers electronic components and driver. Aluminum shroud is made of 0.63" thick aluminum grade 1100-0. The copper shade and trim is made of a C11000 060 copper alloy. The stem and canopy are 6061 grade aluminum.

### Weights:

1400 Rigid Stem Pendant	
Pendant + 36" rigid stem + canopy =	4lbs
Pendant + 48" rigid stem + canopy =	4lbs
Pendant + 96" rigid stem + canopy =	5lbs

1400 Decorative Cord Pendant	
Pendant + 120" of cord + canopy =	3lbs

### Electrical

Standard ELV driver is located in fixture head (120V only / 50-60Hz), and is suitable for ambient temperature of 25°C (77°F).

### LED Optics

Wavestream™ technology enables patented AccuAim™ optics for an enhanced distribution pattern. Available in 2700K, 3000K, 3500K, 4000K and 5000K color temperatures, 90 CRI. Lumen outputs range from 619 to 693 lumens dependent on color temperature.

### Mounting

Pendant head can be attached to a selection of decorative 3-wire power decorative cords, that can be cut in the field to allow for adjustment for variable heights (120" cord length ships standard). Or pendant head can be attached to a rigid pendant stem (36", 48", 96" standard lengths). The canopy mounting plate and cover mounts to a standard 4-gang junction box. The rigid stem has a 20° swivel.

### Finish

Ten mix and match paint colors are

Catalog #		Type
Project		
Comments		Date
Prepared by		

available to choose from for the shade and the trim. They are standard RAL colors in a high gloss sheen. In addition, two metal finishes are also available in natural brushed aluminum or brushed copper, which are spun metal and have a protective clear coat.

### Compliance

Components are UL recognized and luminaires are cULus listed for 25°C (ambient environments). Dry Location Listed.

### Environment

Suited for 25° ambient. Dry location only.

### Control

Standard offering is an electronic low voltage, reverse phase dimmer.

### Life and Warranty

Standard five-year limited warranty on all parts.



**1400**  
LED

Pendant  
Direct

**CERTIFICATION DATA**  
UL/cUL Dry Location Listed  
LM79 / LM80 Compliant

**ENERGY DATA**  
>0.9 Power Factor  
<20% Total Harmonic Distortion  
120V 50/60 Hz  
25°C Ambient Temperature



### Pendant Shade and Trim

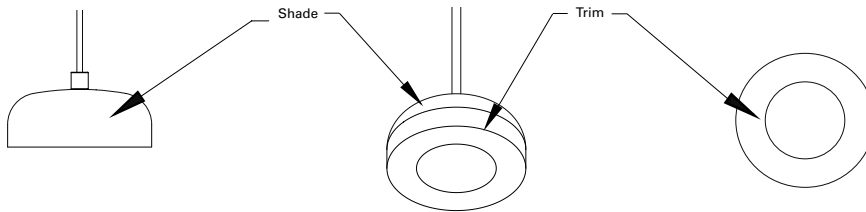

For Adjustable Cord Complete Unit = Sample Catalog #: 1400-DOME-90-L40-120-SOC-TEB-CC-003 (two tone paint - shade and trim example)

For Rigid Stem Complete Unit = Sample Catalog #: 1400-DOME-90-L35-120-SCG-TCG-RS-RS-48-DOME-BA (monotone - shade and trim example)

### ORDERING INFORMATION:

Domestic Preferences <sup>1</sup>	Series	Family	CRI	Color Temperature <sup>2</sup> (Lumens, CRI, wattage)	Voltage	Shade Colors	Trim Colors	Mounting Options (select Color Power Cord or Rigid Stem)	
								Color Power Cord Options	Rigid Stem Option
[Blank] = Standard  TAA = Trade Agreements Act	1400	DOME	90 = 90 CRI	L27 = 619 lumens @90CRI at 2700K, 8.5W  L30 = 635 lumens @90CRI at 3000K, 8.5W  L35 = 651 lumens @90CRI at 3500K, 8.5W  L40 = 693 lumens @90CRI at 4000K, 8.5W	120 = 120V	SRR = Real Red SOC = Orange Crush SYE = Yello? SAL = Avocado Lime SSS = Seafoam See STT = Totally Turquoise SEB = Earth Blue SBM = Black Metal SWL = White Light SCG = Charcoal Gray SCS = Copper Spun SBA = Brushed Aluminum SCC = Custom Color	TRR = Real Red TOC = Orange Crush TYE = Yello? TAL = Avocado Lime TSS = Seafoam See TTT = Totally Turquoise TEB = Earth Blue TBM = Black Metal TWL = White Light TCG = Charcoal Gray TCS = Copper Spun TBA = Brushed Aluminum TCC = Custom Color	CC-119 = Pearl CC-001 = Black CC-029 = Gunmetal Silver CC-620 = Red CC-810 = Orange CC-710 = Yellow Gold CC-320 = Lime Green CC-401 = Cobalt Blue CC-510 = Purple CC-031 = Gray Tweed CC-540 = Magenta CC-002 = Black and White Zig Zag CC-229 = Copper Penny CC-003 = Black and White Houndstooth CC-XXX = Custom Cord Color	RS-36-DOME = 36" Rigid Stem WL = White Stem  RS-48-DOME = 48" Rigid Stem BM = Black Stem  RS-96-DOME = 96" Rigid Stem BA = Brushed Aluminum Stem  RS-CL-DOME = Custom Length (up to 120") CC = Custom Color

NOTES (1) Only product configurations with this designation prefix are built to be compliant with the Trade Agreements Act of 1979 (TAA). Please refer to [DOMESTIC PREFERENCES](#) website for more information. Components shipped separately analyzed under domestic preference requirements. (2) Field Selectable CCT.

**MOUNTING OPTIONS**

**COLOR POWER CORD**

**CC-XXX**

Decorative power cord

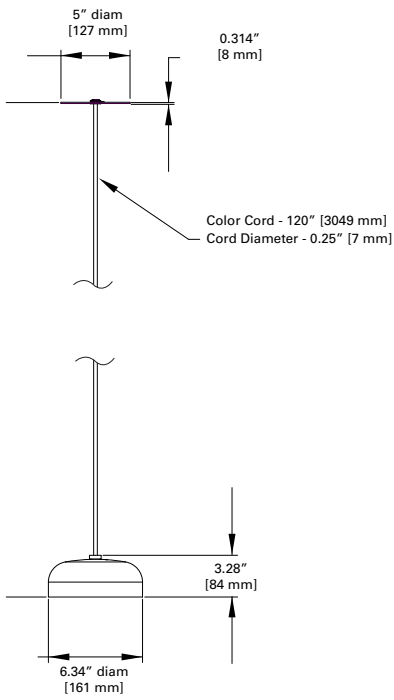

**RIGID STEM**

**1400 - 36"**

Rigid Stem for 36" length

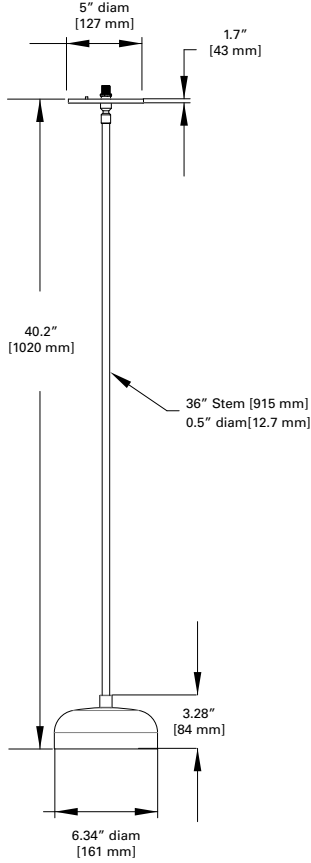

**1400 - 48"**

Rigid Stem for 48" length

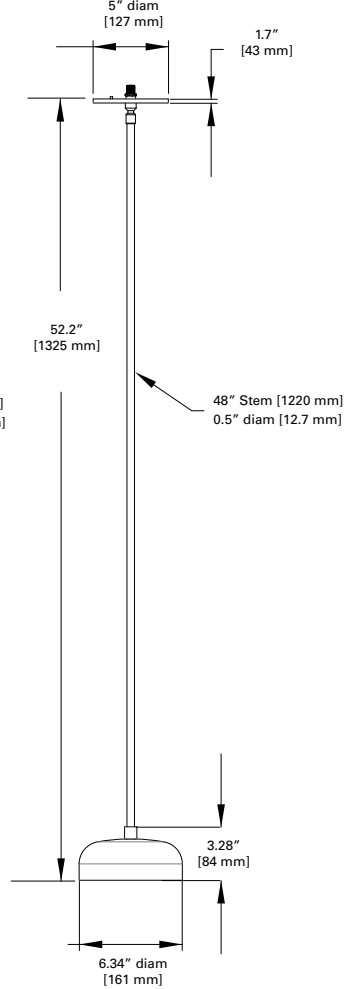

**1400 - 96"**

Rigid Stem for 96" length

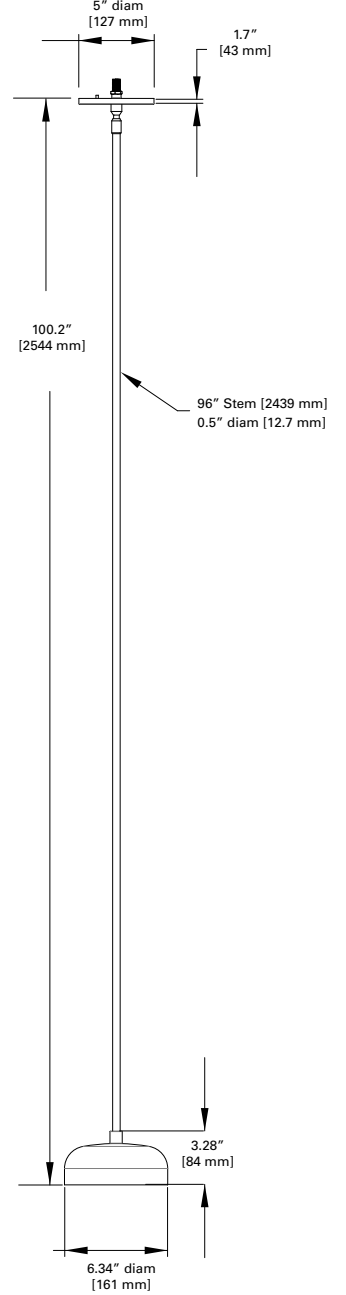

**VIEWS**

Canopy Views

Fixture Head Plan View

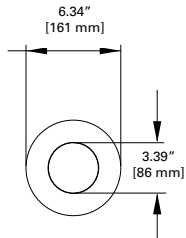
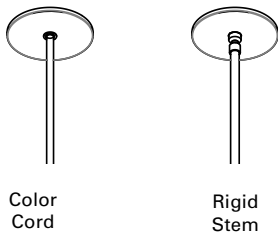

**FINISHES PAINTED AND METALS**

Painted finish is "High Gloss" sheen. A clear coat protectant is applied over the Copper Spun and Brushed Aluminum metal finishes.

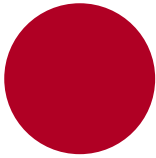

**RR**  
Real Red  
RAL # 3020  
Pantone 485

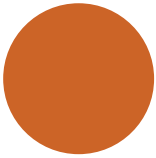

**OC**  
Orange Crush  
RAL#: 2004  
Pantone 1655  
(Pure Orange)

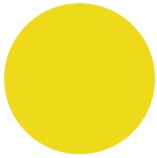

**YE**  
Yello?  
RAL#: 1018  
Pantone 123  
(Zinc Yellow)



**AL**  
Avocado Lime  
RAL#: FGS860016  
Pantone 15-0343  
(Greenery)

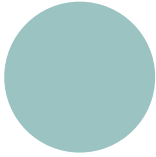

**SS**  
Seafoam See  
RAL#: 6027  
Pantone 631  
(Light Green)



**TT**  
Totally Turquoise  
RAL#: 5018  
Pantone 3145  
(Turquoise Blue)

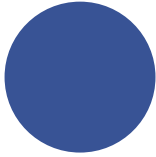

**EB**  
Earth Blue  
RAL#: 5017  
Pantone 2945

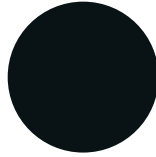

**BM**  
Black Metal  
RAL#: 9005  
Pantone Black  
(Jet Black)



**WL**  
White Light  
RAL#: 9003  
Pantone 705  
(Signal White)



**CG**  
Charcoal Gray  
RAL#: 7024  
Pantone 432  
(Graphite Grey)



**CS**  
Copper Spun  
(Authentic Copper  
Metal with clear coat)

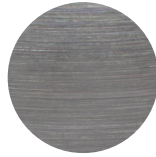

**BA**  
Brushed Aluminum  
(with clear coat)

**COLOR POWER CORD OPTIONS**



**CC-620**  
Red



**CC-401**  
Cobalt  
Blue



**CC-001**  
Black



**CC-810**  
Orange



**CC-510**  
Purple



**CC-029**  
Gunmetal  
Silver



**CC-710**  
Yellow Gold



**CC-540**  
Magenta



**CC-119**  
Pearl



**CC-320**  
Lime Green



**CC-229**  
Copper Penny



**CC-002**  
Black & White  
Zig Zag

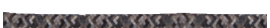

**CC-031**  
Gray Tweed



**CC-003**  
Black & White  
Houndstooth