

Project		Catalog #		Type	
Prepared by		Notes		Date	



## Portfolio

### LDRT8B / LDRT810B / LDRT812B-ER8B-8LB

8" - 12" LED Narrow, Medium or Wide Beam Retrofit/Remodel Downlight  
1,000-20,000 Lumen

#### Typical Applications

Office • Education • Healthcare • Hospitality

#### Interactive Menu

- Order Information page 2
- Product Specifications page 4
- Energy Data page 5
- Photometric Data page 6
- Connected Systems page 8
- Product Warranty

#### Product Certification



#### Product Features



#### Top Product Features

- Retrofits in ceiling openings from 8.7-inch to 12-inch; Flexible disconnect for easy LED engine replacement and installation
- 1,000 to 20,000 lumens; Offered in 80, 90 and 97 CRI; narrow beam, medium beam and wide beam distributions
- Coverts existing 8", 9", 10" and 12" incandescent, HID and compact fluorescent housings to LED
- 2700K, 3000K, 3500K, 4000K, 5000K; D2W™ option from 3000K to 1850K
- W2N tunable white CCT range 2700K to 6500K or 2000K to 5000K

#### Dimensional and Mounting Details

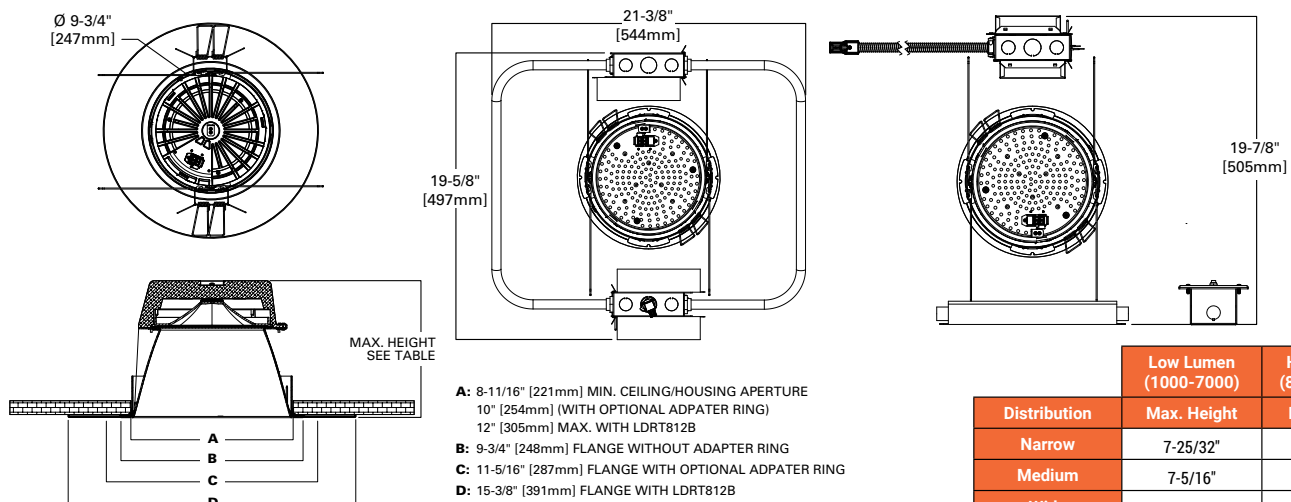

	Low Lumen (1000-7000)	High Lumen (8000-20000)
<b>Distribution</b>	<b>Max. Height</b>	<b>Max Height</b>
Narrow	7-25/32"	9-3/4"
Medium	7-5/16"	9-9/32"
Wide	6-11/16"	8-11/16"
Shallow	4-26/32"	6-26/32"

## Order Information

SAMPLE ORDER NUMBER: **LDRT8B50D010IEMBOD**

Housing	Lumens	Voltage	Driver Options	
Housing	Lumens <sup>(1)</sup>	Voltage <sup>(10)</sup>	1 Driver	2 and 3 Drivers
<b>LDRT8B</b> =LED downlight retrofit 8" nominal Aperture <b>LDRT8BCP</b> =LED downlight Retrofit 8" Nominal Aperture, Chicago Plenum <b>LDRT810B</b> =LED downlight retrofit 10" nominal Aperture, 11.3 OD <b>LDRT810BCP</b> =LED downlight retrofit 10" nominal Aperture, 11.3 OD, Chicago Plenum <b>LDRT812B</b> =LED Downlight Retrofit 12" Nominal Aperture <b>LDRT812BCP</b> =LED Downlight Retrofit 12" Nominal Aperture, Chicago Plenum	<b>10</b> =1000 lumens <b>15</b> =1500 lumens <b>20</b> =2000 lumens <b>30</b> =3000 lumens <b>40</b> =4000 lumens <b>50</b> =5000 lumens <b>60</b> =6000 lumens <sup>(7)</sup> <b>70</b> =7000 lumens <sup>(7)</sup> <b>80</b> =8000 lumens <sup>(7)</sup> <b>90</b> =9000 lumens <sup>(7)</sup> <b>100</b> =10000 lumens <sup>(7)</sup> <b>120</b> =12000 lumens <sup>(7)</sup> <b>150</b> =15000 lumens <sup>(7)</sup> <b>175</b> =17500 lumens <sup>(7)</sup> <b>200</b> =20000 lumens <sup>(7)</sup>	<b>Blank</b> =120-277 7000 lumen and below. <b>3</b> =347V step down transformer <sup>(11)</sup>	<b>1000-4000 Lumen<sup>(13)</sup></b> <b>D010</b> =0-10V Dimming, 1% to 100% <b>D010TR</b> =0-10V 120-277V or 120V Line Voltage Dimming, 1% to 100% <b>DE010</b> =0-10V Linear Dimming, 0% to 100%, 120V-277V <b>D5LT</b> =Fifth Light® DALI DT6 Logarithmic Dimming, 0% to 100%, 120V-277V <b>DMX</b> =DMX/RDM Logarithmic Dimming, 0% to 100%, 120V-277V <sup>(12)</sup> <b>DMXC5</b> =DMX/RDM Logarithmic Dimming, 0% to 100%, 120V-277V, with RJ45 connection <b>DL2</b> =Lutron® Hi-Lume Forward Phase Dimming, 1% to 100%, 120V Only <b>DLE</b> =Lutron Ecosystem dimming 1% to 100% <b>DMXC5</b> =DMX/RDM Logarithmic Dimming 0% to 100% with RJ45 connection  <b>1000-3000 Lumen</b> <b>DLV</b> =Low voltage dimming driver (1-100%) for use with DLVP system  <b>5000, 6000, and 7000 Lumen<sup>(14)</sup></b> <b>D010TE</b> =0-10V or Trailing Edge Dimming, 5% to 100%, 120V-277V (120V Only for Trailing Edge Dimming)  <b>Tunable white 1000-2000</b> <b>DE010W2N</b> =0-10V dimming, 0% to 100%, 120V <b>D5LTW2N</b> =Fifth Light DALI DT6 Logarithmic Dimming, 0% to 100%	<b>4000 and 6000 Lumen D2W (2 Drivers)</b> <b>6000, 8000 and 9000 Lumen (2 Drivers)</b> <b>9000 Lumen D2W (3 Drivers)</b> <b>12,000 Lumen (3 Drivers)</b> <b>1D010</b> =0-10V, 120V Dimming, 1% to 100% <b>2D010</b> =0-10V, 277V Dimming, 1% to 100% <b>1D010TR</b> =0-10V or 120V Line Voltage Dimming, 1% to 100% <b>2D010TR</b> =0-10V, 277V Dimming, 1% to 100% <b>1DE010</b> =0-10V, 120V Linear Dimming, 0% to 100% <b>2DE010</b> =0-10V, 277V Linear Dimming, 0% to 100% <b>1D5LT</b> =120V Fifth Light® DALI DT6 Logarithmic Dimming, 0% to 100% <b>2D5LT</b> =277V Fifth Light® DALI DT6 Logarithmic Dimming, 0% to 100% <b>1DMX</b> =120V, DMX/RDM Logarithmic Dimming, 0% to 100% <sup>(12)</sup> <b>2DMX</b> =277V, DMX/RDM Logarithmic Dimming, 0% to 100% <sup>(12)</sup> <b>1DMXC5</b> =120V, DMX/RDM Logarithmic Dimming, 0% to 100% with RJ45 connection <b>2DMXC5</b> =277V, DMX/RDM Logarithmic Dimming 0% to 100% with RJ45 connection <b>1DL2</b> =120V Lutron® Hi-Lume Forward Phase Dimming, 1% to 100% <b>1DLE</b> =120V, Lutron Ecosystem dimming 1% to 100% <b>2DLE</b> =277V, Lutron Ecosystem dimming 1% to 100%  <b>10,000, 12,000, 15,000, 17,500, 20,000 Lumen</b> <b>1D010TE</b> =0-10V or Trailing Edge Dimming, 5% to 100%, 120V <b>2D010TE</b> =0-10V, 5% to 100%  <b>Tunable white 3000-4000</b> <b>1DE010W2N</b> =0-10V dimming, 0% to 100%, 120V <b>2DE010W2N</b> =0-10V dimming, 0% to 100%, 277V <b>1D5LTW2N</b> =120V, Fifth Light DALI DT6 Logarithmic Dimming, 0% to 100% <b>2D5LTW2N</b> =277V, Fifth Light DALI DT6 Logarithmic Dimming, 0% to 100%

Color Control	Options
Color Control <sup>(9)</sup>	Options
<b>Blank</b> =No color control or D2W for 2000 lumens and below <b>D2W</b> =For 4000, 6000 and 9000 dim 2 warm <b>2050</b> =For W2N 2000K - 5000K <b>2765</b> = For W2N 2700K - 6500K	<b>WTA</b> =Factory installed WaveLinX Sensor Kit <sup>(2) (9) (16)</sup> <b>WTK</b> =Factory installed WaveLinX Lite Sensor Kit <sup>(2) (9) (17)</sup>  <b>EMBOD</b> =Bodine® Emergency Module with Remote Test Switch <sup>(3)</sup> <b>EMBOD7ST</b> =Bodine® Emergency Module with Self Test Remote Test Switch <sup>(3)</sup> <b>EM7</b> =7W Emergency Module with Remote Test Switch <sup>(3)</sup> <b>EM14</b> =14W Emergency Module with Remote Test Switch <sup>(3)</sup> <b>EMV7</b> =7W Low Voltage Emergency Module with Remote Test Switch <sup>(3) (4)</sup> <b>EMV14</b> =14W Low Voltage Emergency Module with Remote Test Switch <sup>(3) (4)</sup>

### Notes

- (1) Nominal Lumens will vary depending on selected color, driver and reflector finish.
- (2) Refer to system specifications for additional information, features and benefits. Order either factory installed option or accessory, use with 0-10V driver.
- (3) Not available with Chicago Plenum or IC rating.
- (4) ULus listed only.
- (7) Product is marked spacing and must be installed with the following minimum spacing
  - Center to center of adjacent luminaires: 36"
  - Center of luminaire to side of building member: 18"
  - Minimum overhead: 1/2"
 20,000 Lumens minimum overhead of 6"
- (9) Field required for D2W 4000, 6000 and 9000 lumens only.
- (10) For single driver.
- (11) 347V step down transformer only available up to 7000 Lumen
- (12) DMX fixtures default to full on upon loss of DMX signal.
- (13) For D2W up to 3000 lumens.
- (14) Not for use with D2W.
- (16) WTA = WaveLinX wireless sensor kit for daylight dimming, PIR motion sensing, and optional RLTS - Real Time Location Services, use with 0-10V only.
- (17) WTK = WaveLinX Lite tile mount sensor kit for daylight dimming, PIR motion sensing, use with D010 only (Refer to WaveLinX Lite system specifications)

## Order Information

SAMPLE ORDER NUMBER: **ER8B30408035**

Power Module	Lumen Levels	Color	
Power Module	Lumen Levels <sup>(1)</sup>	Color	
ER8B=8" LED Module	<b>1 Driver</b> 1020=1000, 1500, or 2000 Lumens 3040=3000 or 4000 Lumens 5070=5000, 6000, or 7000 lumens  <b>2 Drivers</b> 60=6000 lumens, 2 LEDs 80120=8000, 9000, 10000, or 12000 lumens  <b>3 Drivers</b> 120=12000 lumens, 3 LEDs 150200=15000, 17500 or 20000 lumens	<b>80 CRI</b> 8027= 80CRI, 2700K 8030= 80CRI, 3000K 8035= 80CRI, 3500K 8040= 80CRI, 4000K 8050= 80CRI, 5000K	<b>90 CRI</b> 9027= 90CRI, 2700K 9030= 90CRI, 3000K 9035= 90CRI, 3500K 9040= 90CRI, 4000K 9050= 90CRI, 5000K  <b>97 CRI</b> 9727= 97CRI, 2700K 9730= 97CRI, 3000K
	<b>Dim 2 Warm 1 Driver</b> 109030D2W=1000 Lumen, 90 CRI, Dim 2 Warm, IC Rated 159030D2W=1500 Lumen, 90 CRI, Dim 2 Warm, IC Rated 209030D2W=2000 Lumen, 90 CRI, Dim 2 Warm, IC Rated 309030D2W=3000 Lumen, 90 CRI, Dim 2 Warm  <b>Dim 2 Warm 2 Drivers</b> 409030D2W=4000 Lumen, 90 CRI, Dim 2 Warm 609030D2W=6000 Lumen, 90 CRI, Dim 2 Warm  <b>Dim 2 Warm 3 Drivers</b> 909030D2W=9000 Lumen, 90 CRI, Dim 2 Warm	<b>W2N Tunable White 1 Driver<sup>(15)</sup></b> 10W2N902050=1000 lumens, 90 CRI, Tunable white 2000K - 5000K 10W2N902765=1000 lumens, 90 CRI, Tunable white 2700K - 6500K 15W2N902050=1500 lumens, 90 CRI, Tunable white 2000K - 5000K 15W2N902765=1500 lumens, 90 CRI, Tunable white 2700K - 6500K 20W2N902050=2000 lumens, 90 CRI, Tunable white 2000K - 5000K 20W2N902765=2000 lumens, 90 CRI, Tunable white 2700K - 6500K  <b>W2N Tunable White 2 Drivers</b> 30W2N902050=3000 lumens, 90 CRI, Tunable white 2000K - 5000K 30W2N902765=3000 lumens, 90 CRI, Tunable white 2700K - 6500K 40W2N902050=4000 lumens, 90 CRI, Tunable white 2000K - 5000K 40W2N902765=4000 lumens, 90 CRI, Tunable white 2700K - 6500K	

SAMPLE ORDER NUMBER: **8LBM1LI**

Trim	Distribution	Flange	Finish	Options
Trim	Distribution <sup>(5)</sup>	Flange	Finish	Options
8LB=8" Reflector	N=Narrow Spun Aluminum M=Medium Spun Aluminum W=Wide Spun Aluminum S=Shallow Spun Aluminum	0=White Polymer Trim Ring 1=Self-flanged <sup>(8)</sup> 2=White Painted Self-flanged	LI=Specular Clear H=Semi-Specular Clear WMH=Warm Haze WH=Wheat GPH=Graphite Haze B=Specular Black MW=Matte White	E=Integral Emergency Test Switch Hole <sup>(6)</sup>

### Accessories

Accessories
<b>Transformers</b> H347=347 to 120V Step Down Transformer, 75VA H347200=347 to 120V Step Down Transformer, 200VA  <b>Connected Lighting Systems<sup>(2)</sup></b> WTA = Field installed WaveLinX sensor Kit <sup>(16)</sup> WTK = Field installed WaveLinX Lite Sensor Kit <sup>(17)</sup>

### Notes

- (1) Nominal Lumens will vary depending on selected color, driver and reflector finish.
- (2) Refer to system specifications for additional information, features and benefits. Order either factory installed option or accessory, use with 0-10V driver.
- (5) Beam angles are nominal with LI finish trims. See chart.
- (6) DMX fixtures default to full on upon loss of DMX signal.
- (8) Flange is the same finish as the reflector.
- (15) Non-IC.
- (16) WTA = WaveLinX wireless sensor kit for daylight dimming, PIR motion sensing, and optional RLTS - Real Time Location Services, use with 0-10V only.
- (17) WTK = WaveLinX Lite tile mount sensor kit for daylight dimming, PIR motion sensing, use with D010 only (Refer to WaveLinX Lite system specifications)

## Product Specifications

### Lower Shielding Reflector

- Self-flanged, spun .060" thick aluminum lower reflector
- Lensed upper optical chamber
- Provides superior lumen output with minimal source brightness
- Available in all Portfolio Alzak® finishes

### Trim Retention

- Two torsion springs hold lower reflector flange tightly to the finished ceiling surface

### Retrofit Ring

- Galvanized steel ring installs with four mouse trap springs for secure installation
- Accommodates up to 2" ceiling thickness
- Installs in ceiling openings from 8.7" to 10" with optional adapter ring
- Pre-wired flexible conduit with snap in connector installs into 1/2" knockout on the existing junction box

### Thermal

- Aluminum heat sink conducts heat away from the LED module for improved performance and longer life

### LED System

- Contains a plurality of high brightness white LED's combined with a high reflectance upper reflector and transitional lens producing even distribution with no pixilation
- Lumen output shall not decrease by more than 10% over the minimum life of 55,000 hours (L90 > 55,000 hours)
- Color variation within 2-step MacAdam ellipses
- Flexible disconnect allows for tool-less replacement of LED engine from below ceiling
- 2700K, 3000K, 3500K, 4000K and 5000K correlated color temperature (CCT)
- Available in 80, 90 or 97 color rendering index (CRI)

### VividTune™ Color Tuning Solutions

- D2W™ – Dim-to-Warm shifts CCT from 3000K to 1850K as fixture dims, mimicking halogen sources
- W2N – Tunable white CCT range from 2700K to 6500K or 2000K to 5000K; 90 CRI

### Driver

- Combination 0-10V/trailing edge driver provides flicker free dimming from 100% to 10%
- Optional 1% 0-10V, Fifth Light, DMX or Lutron® Ecosystem
- Driver can be serviced from above or through the aperture
- 1,000-7,000 lumens utilize one driver; 8,000-12,000 lumens utilize two drivers; 15,000-20,000 lumens utilize three drivers; reference ordering information for other variations
- Distributed low voltage power system combines power, lighting, and controls with ease of installation.

### Connected Lighting System Options

Two WaveLinX connected systems to choose from. Refer to WaveLinX system specifications and application guides for details.

#### WaveLinX Wireless System Tilemount Sensor Kit

- WaveLinX Wireless WTA tile mount sensor kit offers daylight dimming, PIR motion sensing, scene and zone configuration, automatic commissioning; and optional RLTS - Real Time Location Services available.

#### WaveLinX Lite System Tilemount Sensor Kit

- WaveLinX Lite WTK tile mount sensor kit offers daylight dimming and PIR motion sensing, scene and grouping configuration.

#### WaveLinX Tilemount Kits Application

- The WTA and WTK tilemount kits include a control module mounted on the luminaire junction box via 1/2" knock-out, and a tilemount sensor on 54-inch whip; for ceiling installation by direct-mount spring clips or via mounting bracket in octagon ceiling boxes.

- The WTA and WTK tilemount kits may be ordered as factory installed on the luminaire, or ordered separately as a field installed accessory kit.

### Compliance

- Thermally protected
- cULus Listed for wet locations with covered ceilings
- Optional City of Chicago environmental air (CCEA) marking for plenum applications
- EMI/RFI emissions per FCC 47CFR Part 18 Class B consumer limits
- IC rated up to 3000 Lumens 4000 Lumens and above are non-IC rated
- RoHS compliant
- T24 compliant
- IP20 above ceiling
- IP65 below ceiling
- Photometric testing completed in accordance with IES LM-79 standards
- Lumen maintenance projections in accordance with IES LM-80-08 and TM-21-11
- 6,000 lumens and above are marked spacing and must follow spacing requirements

### Warranty

- Five-year warranty

## Housing Compatibility

Manufr.	Series	Nom. Size	Housing Aperture	Housing Catalog #	Ceiling Aperture	Retrofit Kit
Cooper	Portfolio	8	8.730	C8	8.73" MIN 9" MAX	LDRT8B
Philips	Lightolier Calculite	8	8.750	S8		
Philips	Capri	8	8.875	CM8		
Cooper	PDS	8	8.875	PD8		
Juno		9	8.938	C9H		
Juno	Indy Performance Series (Elate)	9	9.000	C9 and M9	8.73" MIN 10.3" MAX	LDRT810B
Philips	Capri	10	9.625	CM10		
Philips	Omega	10	9.813	OM10 and S10		
Juno	Indy Performance Series (Elate)	10	9.875	M10		
Cooper	Portfolio	9	10.000	C9		
Lithonia	Gotham	10	10.125	GRSF		
Lithonia	Gotham	10	10.125	AF, LGF, LGH, AH, A		
Lithonia	Gotham	10	10.250	GRSH		

## Color Metric Summary

8027		8030		8035		8040		8050		9027	
R <sub>f</sub>	93.2	R <sub>f</sub>	83.4	R <sub>f</sub>	83.7	R <sub>f</sub>	83.3	R <sub>f</sub>	82.5	R <sub>f</sub>	92
R <sub>g</sub>	94.1	R <sub>g</sub>	94.4	R <sub>g</sub>	94.8	R <sub>g</sub>	94	R <sub>g</sub>	94.3	R <sub>g</sub>	98.4
CRI	81.3	CRI	82.4	CRI	83.1	CRI	83.7	CRI	94.2	CRI	93.4
R <sub>9</sub>	0.7	R <sub>9</sub>	4.5	R <sub>9</sub>	9.1	R <sub>9</sub>	9.9	R <sub>9</sub>	11.9	R <sub>9</sub>	59.3

9030		9035		9040		9050		9727		9730	
R <sub>f</sub>	91.6	R <sub>f</sub>	90.9	R <sub>f</sub>	89.4	R <sub>f</sub>	88.4	R <sub>f</sub>	95	R <sub>f</sub>	94.2
R <sub>g</sub>	98.6	R <sub>g</sub>	98.3	R <sub>g</sub>	96.6	R <sub>g</sub>	96.8	R <sub>g</sub>	100.1	R <sub>g</sub>	99.6
CRI	93.2	CRI	93.3	CRI	91.8	CRI	91	CRI	98	CRI	98.5
R <sub>9</sub>	60.2	R <sub>9</sub>	63.1	R <sub>9</sub>	58	R <sub>9</sub>	55.2	R <sub>9</sub>	93.9	R <sub>9</sub>	94.7

## Energy

ENERGY DATA
Sound Rating: Class A standards
(Values at non-dimming line voltage)
Minimum Starting Temperature: -20°C (-4°F)
EMI/RFI: FCC Title 47 CFR, Part 15, Class B (Consumer)
Power Factor: >0.90
Input Frequency: 50-60Hz

	NOMINAL BEAM ANGLES WITH LI FINISH			
	Narrow	Medium	Wide	Shallow
1000-7000	15	40	73	86
8000-12000	30	44	73	86
15000-20000	34	46	73	86

1000 Lumen D010	
Input Power: 11W	THD <14%
Input Current: 0.09A	277V Input Current: 0.04A

1500 Lumen D010	
Input Power: 15.5W	THD <13%
Input Current: 0.13A	277V Input Current: 0.06A

2000 Lumen D010	
Input Power: 21.2 W	THD <9%
Input Current: 0.18A	277V Input Current: 0.08A

3000 Lumen D010	
Input Power: 27.6 W	THD <10%
Input Current: 0.23A	277V Input Current: 0.10A

4000 Lumen D010	
Input Power: 41.6 W	THD <13%
Input Current: 0.35A	277V Input Current: 0.15A

5000 Lumen D010TE	
Input Power: 52.5 W	THD <12%
Input Current: 0.44A	277V Input Current: 0.19A

6000 Lumen D010TE	
Input Power: 59.7W	THD: <14%
Input Current: 0.50A	277V Input Current: 0.22A

7000 Lumen D010TE	
Input Power: 75.8 W	THD <13%
Input Current: 0.64A	277V Input Current: 0.29A

8000 Lumen D010	
Input Power: 73.8 W	THD <13%
Input Current: 0.62A	277V Input Current: 0.26A

9000 Lumen D010	
Input Power: 86.9 W	THD <13%
Input Current: 0.72A	277V Input Current: 0.32A

10000 Lumen D010TE	
Input Power: 115.4 W	THD <13%
Input Current: 0.96A	277V Input Current: 0.42A

12000 Lumen D010TE	
Input Power: 119.4 W	THD <13%
Input Current: 1.0A	277V Input Current: 0.43A



15000 Lumen D010TE	
Input Power: 173.7 W	THD <13%
Input Current: 1.45A	277V Input Current: 0.63A



17500 Lumen D010TE	
Input Power: 179.1 W	THD <13%
Input Current: 1.49A	277V Input Current: 0.65A

20000 Lumen D010TE	
Input Power: 227.4 W	THD <13%
Input Current: 1.9A	277V Input Current: 0.82A

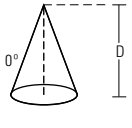
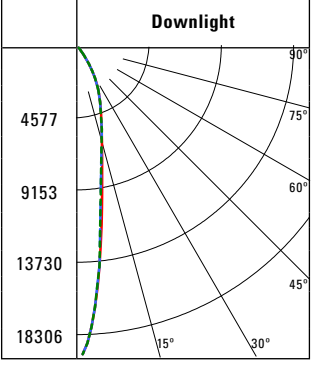
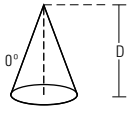
### Photometric Data

 View IES files

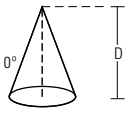
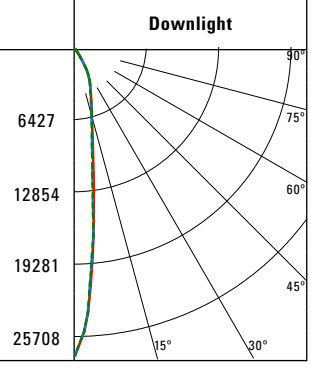
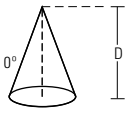
NARROW (15° BEAM)		CANDLEPOWER DISTRIBUTION		CONE OF LIGHT		CANDELA TABLE		ZONAL LUMEN SUMMARY			LUMINANCE					
Test Number		<b>Downlight</b>				Degrees Vertical	Canдела	Zone	Lumens	% Fixture	Average Candela Degrees	Average 0° Luminance				
Housing	LD8B50D010		4577		D	0	18310	0-30	4214	84.5	45	4330				
Module	ER8B50835		9153			MH	FC	L	W	5			14091	0-40	4883	97.9
Trim	8LBN0H		13730			4'	1144.4	1.2	1.2	15			5762	0-60	4983	99.9
Lumens	4986		18306			7'	373.7	2.2	2.2	25			3117	0-90	4986	100
Efficacy	94.1 Lm/W					9'	226.1	2.8	2.8	35			1021	90-180	0	0
SC	0.32		13'	108.3	4	4	45	99	0-180	4986	100	85	0			
			16'	71.5	5	5	55	5								
						65	1									
						75	1									
						85	0									
						90	0									

NARROW (15° BEAM)		CANDLEPOWER DISTRIBUTION		CONE OF LIGHT		CANDELA TABLE		ZONAL LUMEN SUMMARY			LUMINANCE					
Test Number		<b>Downlight</b>				Degrees Vertical	Canдела	Zone	Lumens	% Fixture	Average Candela Degrees	Average 0° Luminance				
Housing	LD8B50D010		6427		D	0	25712	0-30	4514	86	45	4422				
Module	ER8B50835		12854			MH	FC	L	W	5			17790	0-40	5134	97.8
Trim	8LBN0LI		19281			4'	1607	1	1	15			5743	0-60	5238	99.8
Lumens	5248		25708			7'	524.7	1.6	1.6	25			3148	0-90	5248	100
Efficacy	99 Lm/W					9'	317.4	2.2	2.2	35			879	90-180	0	0
SC	0.25		13'	152.1	3.2	3.2	45	101	0-180	5248	100	85	0			
			16'	100.4	4	4	55	7								
						65	7									
						75	4									
						85	0									
						90	0									

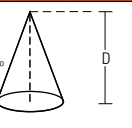
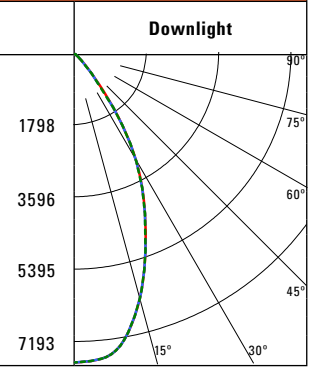
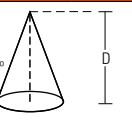
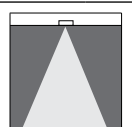
MEDIUM (40° BEAM)		CANDLEPOWER DISTRIBUTION		CONE OF LIGHT		CANDELA TABLE		ZONAL LUMEN SUMMARY			LUMINANCE					
Test Number		<b>Downlight</b>				Degrees Vertical	Canдела	Zone	Lumens	% Fixture	Average Candela Degrees	Average 0° Luminance				
Housing	LD8B50D010		1798		D	0	7197	0-30	4078	75.2	45	10619				
Module	ER8B50835		3596			MH	FC	L	W	5			7141	0-40	5174	95.4
Trim	8LBM0H		5395			4'	449.8	3.2	3.2	15			5914	0-60	5422	99.9
Lumens	5426		7193			7'	146.9	5.6	5.6	25			3883	0-90	5426	100
Efficacy	102.4 Lm/W					9'	88.8	7.2	7.2	35			1774	90-180	0	0
SC	0.8		13'	42.6	10.4	10.4	45	244	0-180	5426	100	85	0			
			16'	28.1	12.8	12.8	55	16								
						65	2									
						75	1									
						85	0									
						90	0									

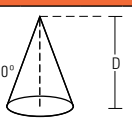
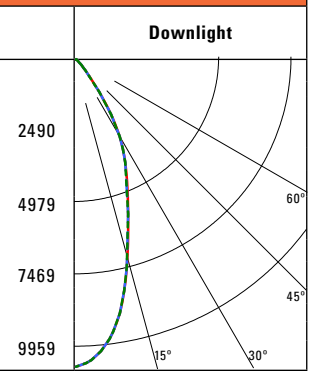
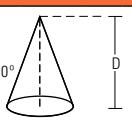
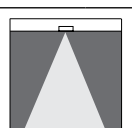
MEDIUM (40° BEAM)		CANDLEPOWER DISTRIBUTION		CONE OF LIGHT		CANDELA TABLE		ZONAL LUMEN SUMMARY			LUMINANCE					
Test Number		<b>Downlight</b>				Degrees Vertical	Canдела	Zone	Lumens	% Fixture	Average Candela Degrees	Average 0° Luminance				
Housing	LD8B50D010		2490		D	0	9963	0-30	4491	78.6	45	9546				
Module	ER8B50835		4979			MH	FC	L	W	5			9498	0-40	5481	96
Trim	8LBM0LI		7469			4'	622.7	2.4	2.4	15			6587	0-60	5702	99.8
Lumens	5711		9959			7'	203.3	4.4	4.4	25			3908	0-90	5711	100
Efficacy	107.8 Lm/W					9'	123	5.6	5.6	35			1559	90-180	0	0
SC	0.63		13'	59	8	8	45	219	0-180	5711	100	85	0			
			16'	38.9	10	10	55	27								
						65	7									
						75	2									
						85	0									
						90	0									

## Photometric Data

 View IES files

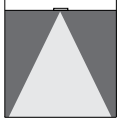
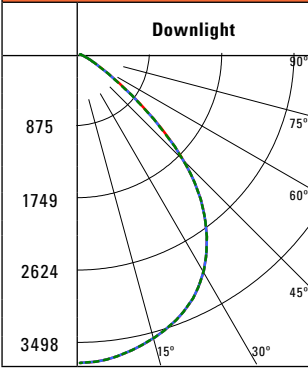
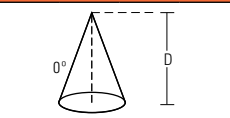
SHALLOW (86° BEAM)	CANDLEPOWER DISTRIBUTION	CONE OF LIGHT	CANDELA TABLE	ZONAL LUMEN SUMMARY	LUMINANCE																																																																																	
<b>Test Number</b> Housing LD8B50D010 Module ER8B50835 Trim 8LBS0H Lumens 6035 Efficacy 113.9 Lm/W SC 1.2 	<b>Downlight</b> 	 <table border="1"> <thead> <tr> <th>MH</th> <th>FC</th> <th>L</th> <th>W</th> </tr> </thead> <tbody> <tr> <td>4'</td> <td>218.9</td> <td>4.6</td> <td>4.6</td> </tr> <tr> <td>7'</td> <td>71.5</td> <td>8.2</td> <td>8.2</td> </tr> <tr> <td>9'</td> <td>43.2</td> <td>10.6</td> <td>10.6</td> </tr> <tr> <td>13'</td> <td>20.7</td> <td>15.4</td> <td>15.4</td> </tr> <tr> <td>16'</td> <td>13.7</td> <td>19</td> <td>19</td> </tr> </tbody> </table>	MH	FC	L	W	4'	218.9	4.6	4.6	7'	71.5	8.2	8.2	9'	43.2	10.6	10.6	13'	20.7	15.4	15.4	16'	13.7	19	19	<table border="1"> <thead> <tr> <th>Degrees Vertical</th> <th>Candela</th> </tr> </thead> <tbody> <tr><td>0</td><td>3502</td></tr> <tr><td>5</td><td>3477</td></tr> <tr><td>15</td><td>3322</td></tr> <tr><td>25</td><td>3056</td></tr> <tr><td>35</td><td>2525</td></tr> <tr><td>45</td><td>1630</td></tr> <tr><td>55</td><td>459</td></tr> <tr><td>65</td><td>84</td></tr> <tr><td>75</td><td>18</td></tr> <tr><td>85</td><td>4</td></tr> <tr><td>90</td><td>0</td></tr> </tbody> </table>	Degrees Vertical	Candela	0	3502	5	3477	15	3322	25	3056	35	2525	45	1630	55	459	65	84	75	18	85	4	90	0	<table border="1"> <thead> <tr> <th>Zone</th> <th>Lumens</th> <th>% Fixture</th> </tr> </thead> <tbody> <tr><td>0-30</td><td>2670</td><td>44.2</td></tr> <tr><td>0-40</td><td>4240</td><td>70.2</td></tr> <tr><td>0-60</td><td>5920</td><td>98.1</td></tr> <tr><td>0-90</td><td>6035</td><td>100</td></tr> <tr><td>90-180</td><td>0</td><td>0</td></tr> <tr><td>0-180</td><td>6035</td><td>100</td></tr> </tbody> </table>	Zone	Lumens	% Fixture	0-30	2670	44.2	0-40	4240	70.2	0-60	5920	98.1	0-90	6035	100	90-180	0	0	0-180	6035	100	<table border="1"> <thead> <tr> <th>Average Candela Degrees</th> <th>Average 0° Luminance</th> </tr> </thead> <tbody> <tr><td>45</td><td>71087</td></tr> <tr><td>55</td><td>24682</td></tr> <tr><td>65</td><td>6100</td></tr> <tr><td>75</td><td>2121</td></tr> <tr><td>85</td><td>1274</td></tr> </tbody> </table>	Average Candela Degrees	Average 0° Luminance	45	71087	55	24682	65	6100	75	2121	85	1274
MH	FC	L	W																																																																																			
4'	218.9	4.6	4.6																																																																																			
7'	71.5	8.2	8.2																																																																																			
9'	43.2	10.6	10.6																																																																																			
13'	20.7	15.4	15.4																																																																																			
16'	13.7	19	19																																																																																			
Degrees Vertical	Candela																																																																																					
0	3502																																																																																					
5	3477																																																																																					
15	3322																																																																																					
25	3056																																																																																					
35	2525																																																																																					
45	1630																																																																																					
55	459																																																																																					
65	84																																																																																					
75	18																																																																																					
85	4																																																																																					
90	0																																																																																					
Zone	Lumens	% Fixture																																																																																				
0-30	2670	44.2																																																																																				
0-40	4240	70.2																																																																																				
0-60	5920	98.1																																																																																				
0-90	6035	100																																																																																				
90-180	0	0																																																																																				
0-180	6035	100																																																																																				
Average Candela Degrees	Average 0° Luminance																																																																																					
45	71087																																																																																					
55	24682																																																																																					
65	6100																																																																																					
75	2121																																																																																					
85	1274																																																																																					

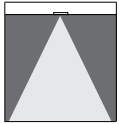
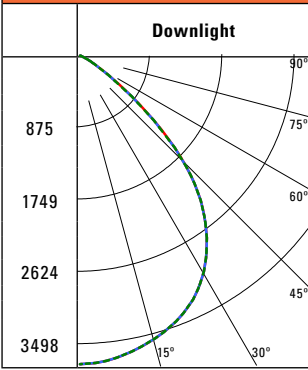
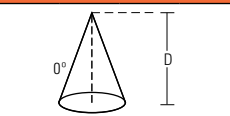
SHALLOW (86° BEAM)	CANDLEPOWER DISTRIBUTION	CONE OF LIGHT	CANDELA TABLE	ZONAL LUMEN SUMMARY	LUMINANCE																																																																																	
<b>Test Number</b> Housing LD8B50D010 Module ER8B50835 Trim 8LBS0LI Lumens 6206 Efficacy 117.1 Lm/W SC 1.28 	<b>Downlight</b> 	 <table border="1"> <thead> <tr> <th>MH</th> <th>FC</th> <th>L</th> <th>W</th> </tr> </thead> <tbody> <tr> <td>4'</td> <td>216.3</td> <td>5</td> <td>5</td> </tr> <tr> <td>7'</td> <td>70.6</td> <td>8.8</td> <td>8.8</td> </tr> <tr> <td>9'</td> <td>42.7</td> <td>11.4</td> <td>11.4</td> </tr> <tr> <td>13'</td> <td>20.5</td> <td>16.6</td> <td>16.6</td> </tr> <tr> <td>16'</td> <td>13.5</td> <td>20.4</td> <td>20.4</td> </tr> </tbody> </table>	MH	FC	L	W	4'	216.3	5	5	7'	70.6	8.8	8.8	9'	42.7	11.4	11.4	13'	20.5	16.6	16.6	16'	13.5	20.4	20.4	<table border="1"> <thead> <tr> <th>Degrees Vertical</th> <th>Candela</th> </tr> </thead> <tbody> <tr><td>0</td><td>3460</td></tr> <tr><td>5</td><td>3462</td></tr> <tr><td>15</td><td>3498</td></tr> <tr><td>25</td><td>3343</td></tr> <tr><td>35</td><td>2681</td></tr> <tr><td>45</td><td>1591</td></tr> <tr><td>55</td><td>418</td></tr> <tr><td>65</td><td>57</td></tr> <tr><td>75</td><td>5</td></tr> <tr><td>85</td><td>2</td></tr> <tr><td>90</td><td>0</td></tr> </tbody> </table>	Degrees Vertical	Candela	0	3460	5	3462	15	3498	25	3343	35	2681	45	1591	55	418	65	57	75	5	85	2	90	0	<table border="1"> <thead> <tr> <th>Zone</th> <th>Lumens</th> <th>% Fixture</th> </tr> </thead> <tbody> <tr><td>0-30</td><td>2850</td><td>45.9</td></tr> <tr><td>0-40</td><td>4513</td><td>72.7</td></tr> <tr><td>0-60</td><td>6132</td><td>98.8</td></tr> <tr><td>0-90</td><td>6206</td><td>100</td></tr> <tr><td>90-180</td><td>0</td><td>0</td></tr> <tr><td>0-180</td><td>6206</td><td>100</td></tr> </tbody> </table>	Zone	Lumens	% Fixture	0-30	2850	45.9	0-40	4513	72.7	0-60	6132	98.8	0-90	6206	100	90-180	0	0	0-180	6206	100	<table border="1"> <thead> <tr> <th>Average Candela Degrees</th> <th>Average 0° Luminance</th> </tr> </thead> <tbody> <tr><td>45</td><td>69395</td></tr> <tr><td>55</td><td>22488</td></tr> <tr><td>65</td><td>4159</td></tr> <tr><td>75</td><td>631</td></tr> <tr><td>85</td><td>637</td></tr> </tbody> </table>	Average Candela Degrees	Average 0° Luminance	45	69395	55	22488	65	4159	75	631	85	637
MH	FC	L	W																																																																																			
4'	216.3	5	5																																																																																			
7'	70.6	8.8	8.8																																																																																			
9'	42.7	11.4	11.4																																																																																			
13'	20.5	16.6	16.6																																																																																			
16'	13.5	20.4	20.4																																																																																			
Degrees Vertical	Candela																																																																																					
0	3460																																																																																					
5	3462																																																																																					
15	3498																																																																																					
25	3343																																																																																					
35	2681																																																																																					
45	1591																																																																																					
55	418																																																																																					
65	57																																																																																					
75	5																																																																																					
85	2																																																																																					
90	0																																																																																					
Zone	Lumens	% Fixture																																																																																				
0-30	2850	45.9																																																																																				
0-40	4513	72.7																																																																																				
0-60	6132	98.8																																																																																				
0-90	6206	100																																																																																				
90-180	0	0																																																																																				
0-180	6206	100																																																																																				
Average Candela Degrees	Average 0° Luminance																																																																																					
45	69395																																																																																					
55	22488																																																																																					
65	4159																																																																																					
75	631																																																																																					
85	637																																																																																					

Nominal Scaling From 80 CRI 3500K		
CRI	CCT	Lumen Mult
80	2700	0.938
80	3000	0.962
80	3500	1.000
80	4000	0.993
80	5000	1.013
90	2700	0.784
90	3000	0.826
90	3500	0.853
90	4000	0.891
90	5000	0.922
97	2700	0.696
97	3000	0.737

Nominal Scaling From 5000 lumen package	
LUMEN PACKAGE	LUMEN MULT
1000 LUMEN	0.207
1500 LUMEN	0.280
2000 LUMEN	0.398
3000 LUMEN	0.562
4000 LUMEN	0.799
5000 LUMEN	1.000
6000 LUMEN	1.133
7000 LUMEN	1.368
8000 LUMEN	1.535
9000 LUMEN	1.729
10,000 LUMEN	1.994
12,000 LUMEN	2.261
15,000 LUMEN	2.949
17,500 LUMEN	3.329
20,000 LUMEN	3.924



## Connected Systems

### WaveLinX Lite - WTK Tilemount Sensor



- Intuitive Android™ or Apple® iOS® app for basic system code compliant set up and configuration via Bluetooth
- Up to 28 unique areas per project site (WaveLinX Lite Bluetooth network)
- Up to 50 devices for an area, any one of 16 control zones, up to 6 occupancy sets, and custom lighting scenes
- Automatic occupancy or vacancy, sensor sensitivity, daylight dimming, etc. configurable through the app
- Refer to the WaveLinX system specifications for details



#### WaveLinX Lite WTK Tilemount Wiring Diagram

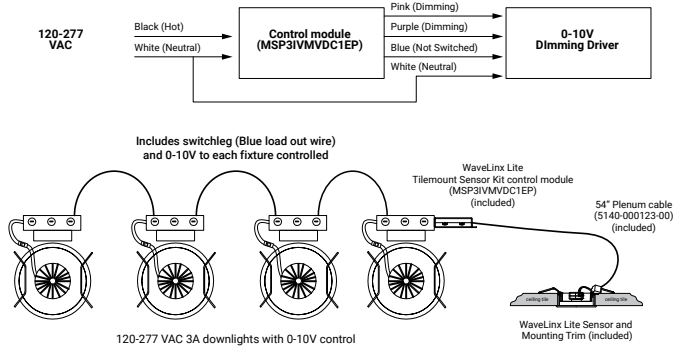

#### WaveLinX Lite Bluetooth Enabled System

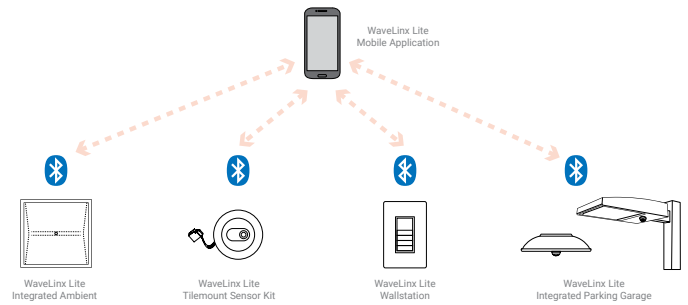

### WaveLinX Wireless – WTA Tilemount Sensor



- WaveLinX Wireless functionality configures zones and customizes settings from one secure mobile app
- Automatic code commissioning that meets the strictest codes
- Fixtures and sensors integrate with Wireless Area Controller, Wall Stations, and Control Devices
- Stand-Alone Offices or Entire Building Network Installations



#### WaveLinX mobile app settings

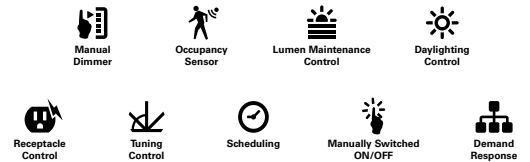

#### WaveLinX Lite WTA Tilemount Wiring Diagram

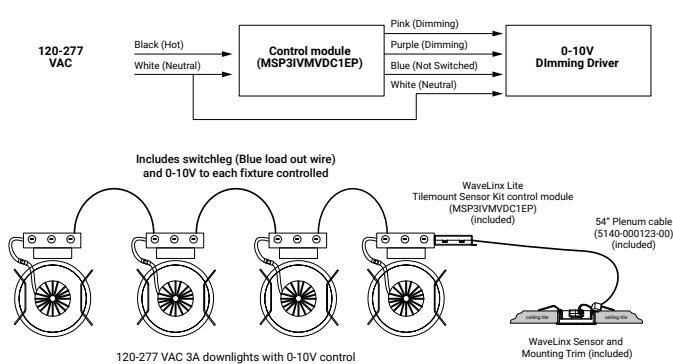

#### WaveLinX Wireless Trellix Building Management Integration

