

Project		Catalog #		Type	
Prepared by		Notes		Date	



Portfolio

LDRT6C | EU6C | 6LB

6" Round, Retrofit/Install from Below Downlight
Narrow, Medium, Wide and Wall Wash
250-15,000 Lumens

Typical Applications

Office • Education • Healthcare • Hospitality • Retail •
Code-Compliance Areas • Sports Venues

Interactive Menu

- Order Information [page 2](#)
- Product Specifications [page 3](#)
- Energy Data [page 4](#)
- Photometric Data [page 5](#)
- Connected System [page 18](#)
- Product Warranty

Product Certification



Control Compatibility



Product Features



Top Product Features

- 250 to 15,000 lumens; Offered in 90 and 97 CRI; ENERGY STAR® qualified
- Remodel, retrofit or international installation; Retrofits existing HID, incandescent or compact fluorescent downlights
- Die-cast or spun aluminum reflectors; Narrow beam, medium beam and wide beam distributions; Optional shallow trim for 2x4 construction
- Standard 0-10V driver dims to 1%; Easy disconnect for LED engine replacement and installation
- 2400K, 2700K, 3000K, 3500K, 4000K, 5000K; D2W™ option from 3000K to 1850K
- Available W2N tunable white CCT range 2700K to 6500K or 2000K to 5000K
- Options to meet Trade Agreements Act requirements

Dimensional and Mounting Details

LDRT6C

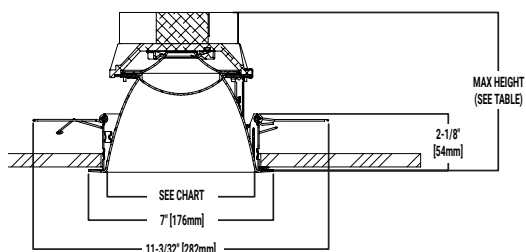

[CLICK HERE - LDRT6C dimension information](#)

LDRT67C

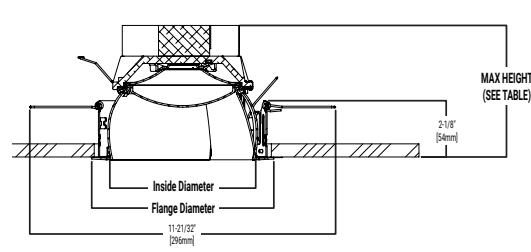

[CLICK HERE - LDRT67C dimension information](#)



Single Line Order Information

SAMPLE ORDER NUMBER: **LDRT6C159035DE010W1LI**

Invoice will indicate separate fixture components (housing, trim, module) which will ship complete from a single CLS facility in separate cartons. To receive separate components (housing, trim, module) shipment, click on the "Multi-Line Ordering Information Option" button to the right.

 Multi-line Ordering Information Option

Housing	Lumen ⁽¹⁾			Color Control	CCT ⁽²⁰⁾	
LDRT6C=LED Retrofit for 6" to 6-7/16" or 8-9/16" with ABR8P openings LDRT6CCP=LED Retrofit for 6" to 6-7/16" or 8-9/16" with ABR8P openings, Chicago Plenum LDRT67C=LED Retrofit for 6-1/2" to 7-1/2" openings LDRT67CCP=LED Retrofit for 6-1/2" to 7-1/2" openings, Chicago Plenum For TAA use Multi-Line Ordering	02 = 250 lumens, IC rated 05 = 500 lumens, IC rated 08 = 800 lumens, IC rated 10 = 1000 Lumens 10IC = 1000 Lumens, IC rated 15 = 1500 Lumens 15IC = 1500 Lumens, IC rated 20 = 2000 Lumens 25 = 2500 lumens	30 = 3000 Lumens 35 = 3500 lumens 40 = 4000 Lumens 45 = 4500 Lumens ⁽¹⁰⁾ 50 = 5000 Lumens ⁽¹⁰⁾ 55 = 5500 Lumens ⁽¹⁰⁾ 60 = 6000 Lumens ⁽¹⁰⁾ 65 = 6500 Lumens ⁽¹⁰⁾ 70 = 7000 Lumens ⁽¹⁰⁾	75 = 7500 Lumens ⁽¹⁰⁾ 80 = 8000 Lumens ⁽¹⁰⁾ 90 = 9000 Lumens ⁽¹⁰⁾ 100 = 10,000 Lumens ⁽¹⁰⁾ 110 = 11,000 Lumens ⁽¹⁰⁾ 120 = 12,000 Lumens ⁽¹⁰⁾ 130 = 13,000 Lumens ⁽¹⁰⁾ 150 = 15,000 Lumens ⁽¹⁰⁾	90=90 CRI Minimum 97=97 CRI Minimum	90 CRI 24=2400K 27=2700K 30=3000K 35=3500K 40=4000K 50=5000K	97 CRI 27=2700K 30=3000K

Driver (Specify from Driver column.)	Specify from Driver column. Information below for reference only.	Driver Options
	Remote driver & plug in driver	
D010=0-10V Dimming, 1% to 100%, 120V-277V, up to 7000 lumens (up to 3000 lumens for remote driver) 1D010=0-10V Dimming, 1% to 100%, 120V, 7500 lumens & above (3500 to 7000 lumens for remote driver) 2D010=0-10V Dimming, 1% to 100%, 277V, 7500 lumens & above (3500 to 7000 lumens for remote driver) 3D010=0-10V Dimming, 1% to 100%, 347V dedicated drivers, 800-4000 lumens; 250, 500, 4500 & above use step down transformer (250 to 7000 lumens for remote driver)	250-7000	Blank = Integral driver RC100 = Remote 100ft ⁽³⁾ (32) RC75 = Remote 75ft ⁽³⁾ (32) RC50 = Remote 50ft ⁽³⁾ (32) RC25 = Remote 25ft ⁽³⁾ RC15 = Remote 15ft ⁽³⁾ RC5 = Remote 5ft ⁽³⁾ RC2 = Remote 2ft ⁽³⁾ PD = Plug in Driver
D010TR=0-10V (120-277V) or Line Voltage (120V) dimming, 5-100%, 250- 4500 lumens (up to 3000 lumens for remote driver) 1D010TR=0-10V or Line Voltage Dimming, 5% to 100%, 120V, 5000-9000 & 13,000 lumens (3500 to 4500 lumens for remote driver) 2D010TR=0-10V Dimming, 5% to 100%, 277V, 5000-9000 & 13,000 lumens (3500 to 4500 lumens for remote driver) 3D010TR=0-10V Dimming, 5% to 100%, 347V step down transformer, 250-9000 & 13,000 lumens (250 to 4500 lumens for remote driver)	250-4500	
DE010=0-10V Dimming, 0% to 100%, 120V-277V, 500-7000 lumens (up to 3000 lumens for remote driver) 1DE010=0-10V Dimming, 0% to 100%, 120V, 7500 lumens & above (3500 to 7000 lumens for remote driver) 2DE010=0-10V Dimming, 0% to 100%, 277V, 7500 lumens & above (3500 to 7000 lumens for remote driver) 3DE010=0-10V Dimming, 0% to 100%, 347V step down transformer, 500-15,000 lumens (500 to 7000 lumens for remote driver)	500-7000	
D5LT=Fifth Light® (DALI T6) Logarithmic Dimming, 0% to 100%, 120V-277V, 500-7000 lumens (up to 3000 lumens for remote driver) 1D5LT=Fifth Light® (DALI T6) Logarithmic Dimming, 0% to 100%, 120V, 7500 lumens & above (3500 to 7000 lumens for remote driver) 2D5LT=Fifth Light® (DALI T6) Logarithmic Dimming, 0% to 100%, 277V, 7500 lumens & above (3500 to 7000 lumens for remote driver) 3D5LT=Fifth Light® (DALI T6) Logarithmic Dimming, 0% to 100% 347V step down transformer, 500-15,000 lumens (500 to 7000 lumens for remote driver)	500-7000	
DMX=DMX/RDM Logarithmic Dimming, 0% to 100%, 120V-277V, 800-4500 lumens (up to 3000 lumens for remote driver) ⁽¹⁴⁾ 1DMX=DMX/RDM Logarithmic Dimming, 0% to 100%, 120V, 5000-9000 & 13,000 lumens (3500 to 4500 lumens for remote driver) ⁽¹⁴⁾ 2DMX=DMX/RDM Logarithmic Dimming, 0% to 100%, 277V, 5000-9000 & 13,000 lumens (3500 to 4500 lumens for remote driver) ⁽¹⁴⁾ 3DMX=DMX/RDM Logarithmic Dimming, 0% to 100%, 347V step down transformer, 800-9000 & 13,000 lumens (800 to 4500 lumens for remote driver) ⁽¹⁴⁾	800-4500	
DMXC5=DMX/RDM Logarithmic Dimming, 0% to 100%, 120V-277V, 800-4500 lumens, RJ45 Connection (up to 3000 lumens for remote driver) ⁽¹⁴⁾ 1DMXC5=DMX/RDM Logarithmic Dimming, 0% to 100%, 120V, 5000-9000 & 13,000 lumens, RJ45 Connection (3500 to 4500 lumens for remote driver) ⁽¹⁴⁾ 2DMXC5=DMX/RDM Logarithmic Dimming, 0% to 100%, 277V, 5000-9000 & 13,000 lumens, RJ45 Connection (3500 to 4500 lumens for remote driver) ⁽¹⁴⁾ 3DMXC5=DMX/RDM Logarithmic Dimming, 0% to 100%, 347V step down transformer, 800-9000 & 13,000 lumens, RJ45 Connection (800 to 4500 lumens for remote driver) ⁽¹⁴⁾	800-4500	
1DL2 = Lutron® Hi-Lume Forward Phase Dimming, 1% to 100%, 120V, 800-7500 lumens (800 to 3500 lumens for remote driver) 3DL2 = Lutron® Hi-Lume Forward Phase Dimming, 1% to 100%, 347V step down transformer, 800-7500 lumens (800 to 3500 lumens for remote driver)	800-3500	
DLE=Lutron Ecosystem dimming 1% to 100%, 120V-277V, 800-3500 lumens (up to 3000 lumens for remote driver) 1DLE=Lutron Ecosystem dimming 1% to 100%, 120V, 4000-7500 lumens (3500 lumens for remote driver) 2DLE=Lutron Ecosystem dimming 1% to 100%, 277V, 4000-7500 lumens (3500 lumens for remote driver) 3DLE=Lutron Ecosystem dimming 1% to 100%, 347V step down transformer, 800-7500 lumens (800-3500 lumens for remote driver)	800-3500	
DLV = Low voltage dimming driver (1-100%) for use with DLVP system 800-3000 lumens ⁽³⁾	800-3000 (Remote driver only)	

Trim Distribution ⁽⁵⁾	Trim Flange	Trim Finish	Options ⁽³⁾ (16) (30)
N=Narrow, Spun Aluminum ⁽²⁶⁾ M=50° Cutoff, Medium Beam Reflector, Spun Aluminum MD=45° Cutoff, Medium Beam Reflector, Spun Aluminum W=Wide, Spun Aluminum S=Shallow, Spun Aluminum HY=Hyperbolic medium beam ^{(26) (29)} PS=Non-Conductive Shallow, Injection Molded white ⁽¹¹⁾⁽¹²⁾ CS=Cast Shallow, Die Cast Aluminum BA=Spun Aluminum Baffle ⁽⁷⁾ Wall Wash SWN = Single Wall Wash, Spun Aluminum ⁽²³⁾ DWN = Double Wall Wash, Spun Aluminum ⁽²³⁾ CW = Corner Wall Wash, Spun Aluminum ⁽²³⁾ LSWW = Lensed Single wall wash, Spun Aluminum LDWW = Lensed Double wall wash, Spun Aluminum	0=White Polymer Trim Ring 1=Self-flanged ⁽¹³⁾ 2=White Painted Self-flanged	LI=Specular Clear ⁽⁹⁾ H=Semi-Specular Clear ⁽⁹⁾ WMH=Warm Haze ⁽⁹⁾ WH=Wheat ⁽⁹⁾ GPH=Graphite Haze ⁽⁹⁾ B=Specular Black ⁽⁹⁾ MW=Matte White (Antimicrobial) MB=Matte Black ⁽⁸⁾ MMS=Matte Metallic Silver ⁽⁸⁾	EMBOD=Bodine® Emergency Module with Remote Test Switch ⁽²⁵⁾ EMBOD6ST=Bodine® 6W Self Test Emergency Module with Remote Test Switch EM7=7W Emergency Module with Remote Test Switch EM14=14W Emergency Module with Remote Test Switch EMBOD7ST=Bodine® Self Test Emergency Module ⁽²⁵⁾ EMV7=7W Low Voltage Emergency Module with Remote Test Switch ⁽⁴⁾ EMV14=14W Low Voltage Emergency Module with Remote Test Switch ⁽⁴⁾ ETRD=Emergency transfer device ⁽³¹⁾ WPST = Factory installed Wavelinx (includes control module, sensor, cable, tilemount and ceiling mount sensor) ^{(15) (18)} WLST = Factory installed Wavelinx LITE Sensor Kit ^{(15) (17)} WPN = WaveLinX PRO Wireless Node without sensor ⁽³³⁾

Continued on next page.

Single Line Order Information

Accessories (Sold separately) ⁽²²⁾

TRM6P=White Metal Trim Ring ⁽²⁾
LGSKT6IP66=IP66 Gasket Kit
DT6RF=Deco Trim Ring Frosted ⁽²⁸⁾

Connected Lighting Systems ^{(3) (15)}
WPST = Field installed WaveLinX sensor Kit ⁽¹⁷⁾
WLST = Field installed WaveLinX LITE Sensor Kit ⁽¹⁸⁾

Transformers
H347=H347 for 90/97CRI 5500 lumens and below; 98CRI 4000 lumens and below; D2W 4500 lumens and below; W2N 4000 lumens and below
H347200=347 to 120V Step Down Transformer, 200VA

Notes:

1. Nominal Lumens will vary depending on selected color, CRI, driver and reflector finish. Reference [Multiplier tables](#).
2. Order trim with polymer trim ring.
3. Not available with Chicago Plenum.
4. ULus listed only
5. Beam angles are nominal with LI finish trims.
6. Available with remote driver only.
7. Only available with Matte White and Matte Black Finishes.
8. Available only on CS distributions.
9. Not available on PS, CS or BA distributions.
10. Product is marked spacing. [Reference table on page 4](#).
11. PS available in self-flanged MW finish only.
12. Offered up to 2000 lumens
13. Flange is the same finish as the reflector
14. DMX fixtures default to full on upon loss of DMX signal.

15. Refer to system specifications for additional information, features, and benefits. Order either factory installed option or accessory. Use with 0-10V driver.
16. Non-IC
17. WLST = WaveLinX LITE tilemount sensor kit for daylight dimming, PIR motion sensing, use with D010 only (Refer to WaveLinX LITE system specifications)
18. WPST = WaveLinX wireless sensor kit for daylight dimming, PIR motion sensing, and optional RLTS - Real Time Location Services, use with 0-10V only.
20. Not required for W2N and D2W.
21. Limited to 1000 lumens with remote driver
22. Accessories sold separately will be separately analyzed under domestic preference requirements. Consult factory for further information.
23. For use with LDRT67C only
25. Not available for W2N or 6500-7000 lumens with 90 and 97 CRI
26. Offered up to 7000 lumens
27. Not available with 5500, 6500, 7500.

28. Order with self flanged trim.
29. Offered with DLVP up to 3000 lumens for 90 and 97 CRI and 2000 lumens with 98 CRI.
30. 120V-277V
31. Used to bypass local control during outage. Must be used in conjunction with UL 1008 device (provided by others)
32. Not available with Lutron drivers
33. WPN = WaveLinX PRO wireless node provides luminaire-level control with scene and zone configuration without an integrated sensor; Connects wirelessly with daylight dimming sensor and PIR motion sensor if desired. Use with 0-10V driver only.

Product Specifications

Lower Shielding Reflector

- Painted die-cast aluminum or spun aluminum lower reflector with lensed upper optical chamber provides superior lumen output with minimal source brightness
- Spun reflectors are available in all Portfolio anodized finishes
- Hyperbolic reflector provides minimal aperture brightness and glare.
- Available with non-conductive polymer reflector up to 2000 lumens

Wall Wash Reflector

- Open Wall Wash** - wall wash reflector with gradient kicker offered in single, double and corner wall wash provides even vertical illumination with minimal source brightness.
- Rotatable Lensed Wall Wash** - Rotatable Lensed wall wash reflector offered in single and double wall wash provides even vertical illumination with minimal source brightness.

Trim Retention

- Two torsion springs hold reflector flange tightly to the finished ceiling surface

Plaster Frame/Collar

- Die-cast aluminum 1 1/2" deep collar
- Accommodates up to 2" ceiling thickness

Plaster Ring

- Galvanized steel ring installs with 2 mouse trap springs for secure installation and accommodates up to 2 inch ceiling thickness.
- Retrofit - Converts existing HID, incandescent or compact fluorescent downlights to energy saving LED.
- Simple below ceiling installation without removing the existing fixture. Pre-wired flexible conduit with snap in connector installs into 1/2" knockout on the existing junction box.
- LDRT6B includes oversize adapter ring for larger openings

Thermal

- Aluminum heat sink conducts heat away from the LED module for improved performance and longer life

LED System

- Contains a plurality of high brightness white LED's combined with a high reflectance upper reflector and convex transitional lens producing even distribution without pixilation
- Auto resetting, thermally protected, LED's are turned off when safe operating temperatures are exceeded
- Quick disconnect allows for tool-less replacement of LED engine from below ceiling
- 90 and 97 CRI

- 90 & 97CRI: L78 55,000 hours for 1000-2000 lumens, L90 55,000 for all other lumen output
- Color variation within 2-step MacAdam ellipses
- Available in 2400K, 2700K, 3000K, 3500K, 4000K and 5000K correlated color temperature (CCT)

Vividtune and High CRI

- 98 CRI and W2N: L70 55,000 hours
- D2W™ – dim-to-warm shifts CCT from 3000K to 1850K as fixture dims mimicking halogen sources.
- W2N - Tunable white CCT range 2700K to 6500K or 2000K to 5000K, 90 CRI. Standard
- 98 CRI** With a full-spectrum approach using broad-blue chip technology and special phosphor blends, Thrive is able to closely match the spectrum of the sun across all color temperatures. Benefits of the natural spectrum of the sun using Thrive include superior accurate color rendering, reduced eye strain, and a higher sense of emotional well-being.
- See dedicated specification sheet for more details.

Driver

- Standard 120-277V 0-10V dimming driver provides flicker free dimming from 100% to 1%
- Optional 120V leading edge/0-10V, <1% 0-10V, Fifth Light, DMX or Lutron® Ecosystem
- Driver can be serviced from above or through the aperture
- Distributed low voltage power system combines power, lighting, and controls with ease of installation.
- Optional magnetically guided snap in driver for ease of maintenance.

Emergency Option

- Provides 90 minutes of standby lighting, meeting most life safety codes for egress lighting
- Available with remote charge indicator and test switch
- Available Self-Test (self-diagnostic) with remote charge indicator and test switch
- Emergency Transfer Relay Device bypasses local control during a power outage
- UL 924 listed

Connected Lighting System

Two WaveLinX connected solutions to choose from. Refer to WaveLinX system specifications and application guides for details.

WaveLinX PRO Tilemount Sensor Kit

- WaveLinX WPST tilemount sensor kit offers daylight dimming, PIR motion sensing, scene and zone configuration, automatic commissioning; and optional RLTS - Real Time Location Services available.

WaveLinX PRO Wireless Node

- WaveLinX PRO wireless node provides luminaire-level control with scene and zone configuration without an integrated sensor; Connects wirelessly with daylight dimming sensor and PIR motion sensor if desired. Use with 0-10V driver only.

WaveLinX LITE Tilemount Sensor Kit

- WaveLinX LITE WLST tilemount sensor kit offers daylight dimming and PIR motion sensing, scene and grouping configuration.

WaveLinX Tilemount Kits Application

- The WPST and WLST tilemount kits include a control module mounted on the luminaire junction box via 1/2" knock-out, and a tilemount sensor on 54-inch whip; for ceiling installation by direct-mount spring clips or via mounting bracket in octagon ceiling boxes.
- The WPST and WLST tilemount kits may be ordered as factory installed on the luminaire, or ordered separately as a field installed accessory kit.

Code Compliance

- Thermally protected
- cULus Certified to UL 1598 / C22.2 No. 250.0 suitable for wet locations with downlight; damp location with wall wash and hyperbolic with covered ceiling
- Optional City of Chicago environmental air (CCEA) marking for plenum applications
- FCC CFR Title 47 Part 15 Class B at 120VAC and Class A at 277VAC
- Insulated ceiling (IC) rated up to 1,500 lumens (90 and 97CRI). All others are non-IC rated (insulation must be kept 3" from top and sides of housing).
- Can be used for State of California Title 24 high efficacy LED compliance under JA8, reference Modernized Appliance Efficiency Database System (MAEDBS) for 2016 JA8 High Efficacy Lighting
- RoHS compliant
- Photometric testing completed in accordance with IES LM-79
- LED life testing completed in accordance with IES LM-80-08 and TM-21-11 standards
- See table on page 3 for marked spacing requirements.

Warranty

- Five year warranty www.cooperlighting.com/legal

Marked Spacing

6-inch Marked spacing for 90 and 97 CRI			
4500-6000	36	36	6
6500-15,000	36	36	8

Dimensional and Mounting Details

LDRT6C

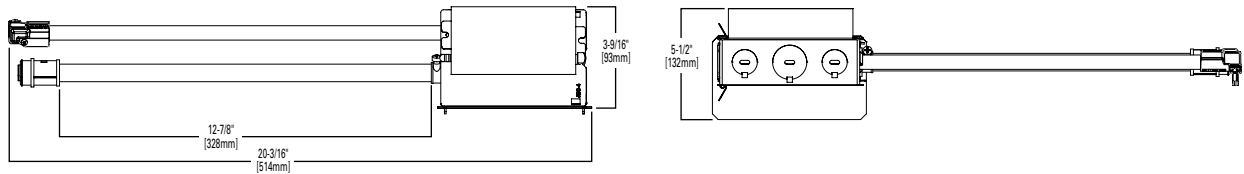
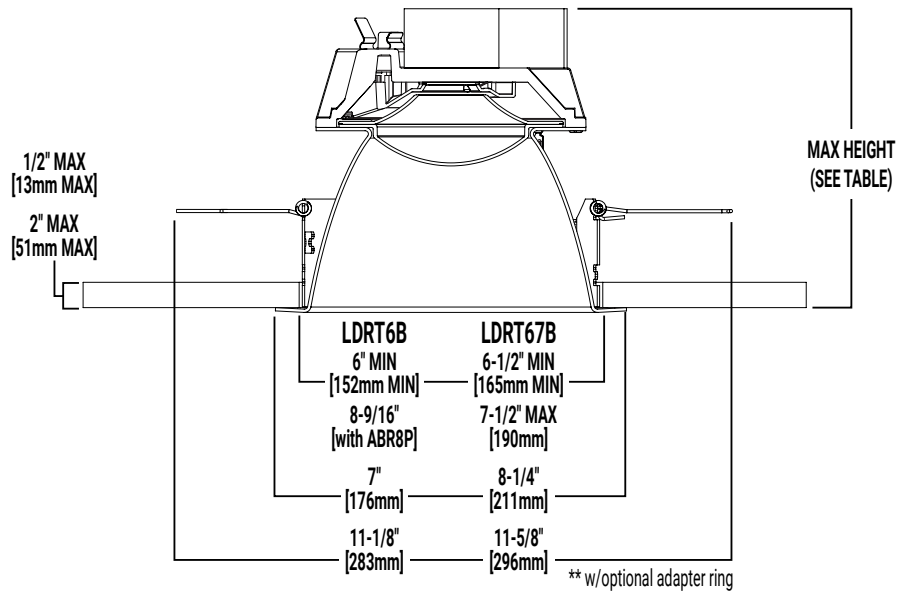

CATALOG #	INSIDE DIAMETER [IN]	MAX HEIGHT				
		250-2500 LUMENS	3000-4000 LUMENS	1000-1500C LUMENS (90/97CRI) 4500-6000 LUMENS (90/97CRI)	6500-7000 LUMENS (90/97CRI) 4000-8000 LUMENS (90/97CRI)	9000-15000 LUMENS (90/97CRI)
6LBN	5.54	5.7	5.9	6.1	7.1	9.1
6LBM	5.54	5.7	5.9	6.1	7.1	9.1
6LBW	5.56	4.8	5	5.2	6.2	8.2
6LBBA	5.56	5.7	5.9	6.1	7.1	9.1
6LBMD	5.55	6.7	6.9	7	8	10
6LBHY	5.68	5.9	6	6.2	7.2	9.2
6LBS	5.62	3.5	3.5	3.7	4.7	6.7
6LBPS	5.66	3.5	3.5	3.7	4.7	6.7
6LBCS	5.66	3.5	3.5	3.7	4.7	6.7
6LBSWN	5.56	4.8	5	5.2	6.2	8.2
6LBDWN	5.56	4.8	5	5.2	6.2	8.2
6LBCW	5.14	4.9	5.1	5.3	6.3	8.3
6LBLSWW	5.56	4.8	5	5.2	6.2	8.2
6BLDWW	5.56	4.8	5	5.2	6.2	8.2

Energy and Performance Data

D010 DRIVER ENERGY DATA

Series	250 lumen		500 lumen		800 lumen		1000 lumen		1500 lumen		2000 lumen	
Input Voltage 120-277VAC	120V	277V	120V	277V	120V	277V	120V	277V	120V	277V	120V	277V
Input Current (A)	0.029	0.017	0.061	0.032	0.085	0.041	0.084	0.042	0.135	0.063	0.189	0.084
Input Power (W)	3.45	3.87	7.33	7.78	10.15	10.52	10.04	10.43	16.17	16.56	22.58	22.63
In-rush (A)	2.1	8.5	3.7	8.5	3.6	8.3	3.6	8.4	2.3	9.5	2.1	9.7
Inrush duration (µs)	250	131	190	136	220	135	226	136	230	125	243	132
THDi (%)	7.21	16.92	7.82	10.78	5.57	9.63	7.78	9.24	4.75	9.93	8.03	7.44
PF	≥ 0.98	≥ 0.9	≥ 0.99	≥ 0.93	≥ 0.99	≥ 0.95	≥ 0.99	≥ 0.95	≥ 0.99	≥ 0.94	≥ 0.99	≥ 0.96

Series	2500 lumen		3000 lumen		3500 lumen		4000 lumen		4500 lumen		5000 lumen	
Input Voltage 120-277VAC	120V	277V	120V	277V	120V	277V	120V	277V	120V	277V	120V	277V
Input Current (A)	0.276	0.121	0.276	0.121	0.333	0.152	0.404	0.181	0.421	0.192	0.491	0.216
Input Power (W)	32.98	32.57	32	32.57	39.83	39.84	48.38	47.94	50.22	50.17	58.69	58.01
In-rush (A)	2.5	11.8	3.6	11.8	3.1	14.3	3.1	14.5	5.6	22.6	5.6	22.6
Inrush duration (µs)	215	111	220	111	200	94	197	95	215	120	213	135
THDi (%)	9.86	6.57	5.57	6.57	4.25	10.05	5.02	7.97	6.12	8.35	8.51	7.92
PF	≥ 0.99	≥ 0.97	≥ 0.99	≥ 0.99	≥ 0.99	≥ 0.94	≥ 0.99	≥ 0.95	≥ 0.99	≥ 0.95	≥ 0.99	≥ 0.96

Series	5500 lumen		6000 lumen		6500 lumen		7000 lumen		7500 lumen		8000 lumen	
Input Voltage 120-277VAC	120V	277V	120V	277V	120V	277V	120V	277V	120V	277V	120V	277V
Input Current (A)	0.526	0.231	0.542	0.256	0.572	0.266	0.632	0.292	0.668	0.306	0.734	0.332
Input Power (W)	62.97	61.97	64.88	65.7	68.35	69.02	75.56	75.85	79.89	80.09	88.01	87.81
In-rush (A)	5.1	23.1	6.2	27.5	6.3	28.4	6.4	29.1	6.4	28.7	6.3	29.7
Inrush duration (µs)	217	138	188	101	189	92	187	90	185	100	187	123
THDi (%)	9.42	7.16	4.33	11.86	4.38	11.33	4.84	10.32	4.46	9.85	3.92	8.92
PF	≥ 0.99	≥ 0.96	≥ 0.99	≥ 0.93	≥ 0.99	≥ 0.93	≥ 0.99	≥ 0.94	≥ 0.99	≥ 0.94	≥ 0.99	≥ 0.95

Series	9000 lumen		10000 lumen		11000 lumen		12000 lumen		13000 lumen		15000 lumen	
Input Voltage 120-277VAC	120V	277V	120V	277V	120V	277V	120V	277V	120V	277V	120V	277V
Input Current (A)	0.842	0.374	0.961	0.416	1.09	0.49	1.192	0.512	1.263	0.561	1.446	0.624
Input Power (W)	101.12	99.88	114.86	113.66	130.27	127.6	142.59	140.17	151.68	149.82	172.29	170.51
In-rush (A)	12.9	28.6	11.4	40.3	11.5	40.2	11.5	41.2	19.2	43.1	17.2	40.4
Inrush duration (µs)	170	97	248	124	233	118	246	114	170	97	240	125
THDi (%)	5.74	9.28	7.42	8.55	6.08	13.13	5.7	7.3	5.74	7.58	5.86	8.56
PF	≥ 0.99	≥ 0.95	≥ 0.99	≥ 0.98	≥ 0.99	≥ 0.9	≥ 0.99	≥ 0.99	≥ 0.99	≥ 0.96	≥ 0.99	≥ 0.98

Minimum starting temperature -30°C (-22°F)*
(Nominal input 120-277VAC & 100% of rated output power)

Sound Rating: Class A standards

Notes:
Emergency Battery packs are rated for a minimum starting temperature of 0°C.

COLOR METRICS - TM-30-15 & CRI/CIE

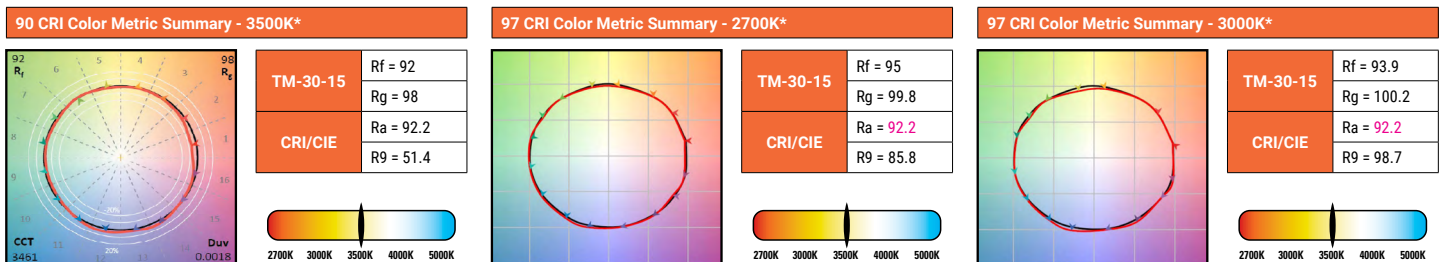

* Color values are based on haze reflector, other finishes and field results may vary.

LDRT6C

Manufacturer	Series	Nom. Size	Housing Aperture	Housing Catalog #	Ceiling Aperture	Retrofit Kit	Oversize Adapter Ring
Cooper	Portfolio	6	6.000	C6, MD6, H760, HD6, LD6	6" MIN 6-7/16" MAX	LDRT6C	None
	PDS	6	6.000	PD6			
Philips	Omega	6	6.250	OM6			
	Lightolier Calculite	6	6.313	S6, C6, B600			
	Capri	6	6.438	CM6			
Cooper	Portfolio	7	7.700	C7, HD7, MD7	6" MIN 8-9/16" MAX	LDRT6C	ABR8 (Accessory)
Juno	Indy Performance Series (Elate)	8	7.813	A8, C8, M8			
		8	7.813	CH8 and CV8			
		8	8.188	MX8 and TC908			
Lithonia	Gotham	8	8.438	AF and LG			
	Gotham	8	8.563	GRSF			
Philips	Omega	8	8.563	OM8			
Lithonia	Commercial	8	8.563	LF8, LP8			

LDRT67C

Manufacturer	Series	Nom. Size	Housing Aperture	Housing Catalog #	Ceiling Aperture	Retrofit Kit	Oversize Adapter Ring
Juno	Indy Performance Series (Elate)	6	6.563	A6, C6, M6	6-1/2" MIN 7-5/8" MAX	LDRT67C	ABR7 (included)
Juno		6	6.563	CH6, CV6, MX6, TC906			
Lithonia	Commercial	6	6.750	LF6, LP6			
Philips	Lightolier Lytecaster	6	6.750	1102			
Lithonia	Gotham	6	6.750	AF and LG			
Cooper	Portfolio CFL (New)	6	6.750	CD6			
Cooper	Halo	7	6.875	M700, H600, H803E			
Cooper	Halo Commercial	6	7.125	PD6 (New)			
Philips	Lightolier Calculite	7	7.500	S7 and CS7			
Cooper	PDS	7	7.625	GRSF			

Note: Retrofit kit includes oversize trim ring.

Photometric Data

[View IES files](#)

MEDIUM 60° BEAM (H)		CANDLEPOWER DISTRIBUTION				CONE OF LIGHT				CANDELA TABLE		ZONAL LUMEN SUMMARY			LUMINANCE	
Test Number	P571658									Degrees Vertical	Canдела	Zone	Lumens	% Fixture	Average Candela Degrees	Average 0° Luminance
Housing	LDRT6C20D010									0	1493	0-30	947	62.8	37	30591
Module	EU6C10259035	5	1461	0-40	1287	85.3	45	13699								
Trim	6LBMH	15	1261	0-60	1482	98.2	55	5142								
Lumens	1509	25	1015	0-90	1509	100	65	2516								
Efficacy	69.2 Lm/W	35	539	90-180	0	0	75	1377								
SC	0.94	45	177	0-180	1509	100	85	0								
UGR	12.5	55	54													
		65	19													
		75	6													
		85	0													
		90	0													

MEDIUM 55° BEAM (LI)		CANDLEPOWER DISTRIBUTION				CONE OF LIGHT				CANDELA TABLE		ZONAL LUMEN SUMMARY			LUMINANCE	
Test Number	P571659									Degrees Vertical	Canдела	Zone	Lumens	% Fixture	Average Candela Degrees	Average 0° Luminance
Housing	LDRT6C20D010									0	2311	0-30	1359	73.6	37	30951
Module	EU6C10259035	5	2281	0-40	1737	94	45	8063								
Trim	6LBMLI	15	1903	0-60	1841	99.7	55	898								
Lumens	1847	25	1364	0-90	1847	100	65	623								
Efficacy	84.7 Lm/W	35	591	90-180	0	0	75	508								
SC	0.85	45	104	0-180	1847	100	85	0								
UGR	1.3	55	9													
		65	5													
		75	2													
		85	0													
		90	0													

NARROW 55° BEAM (H)		CANDLEPOWER DISTRIBUTION				CONE OF LIGHT				CANDELA TABLE		ZONAL LUMEN SUMMARY			LUMINANCE	
Test Number	P571660									Degrees Vertical	Canдела	Zone	Lumens	% Fixture	Average Candela Degrees	Average 0° Luminance
Housing	LDRT6C20D010									0	1665	0-30	916	70.5	37	23572
Module	EU6C10259035	5	1618	0-40	1191	91.7	45	6977								
Trim	6LBNH	15	1282	0-60	1289	99.2	55	2045								
Lumens	1299	25	893	0-90	1299	100	65	921								
Efficacy	59.6 Lm/W	35	438	90-180	0	0	75	508								
SC	0.78	45	90	0-180	1299	100	85	0								
UGR	6.9	55	21													
		65	7													
		75	2													
		85	0													
		90	0													

NARROW 30° BEAM (LI)		CANDLEPOWER DISTRIBUTION				CONE OF LIGHT				CANDELA TABLE		ZONAL LUMEN SUMMARY			LUMINANCE	
Test Number	P571661									Degrees Vertical	Canдела	Zone	Lumens	% Fixture	Average Candela Degrees	Average 0° Luminance
Housing	LDRT6C20D010									0	3738	0-30	1320	80.4	37	21389
Module	EU6C10259035	5	3483	0-40	1580	96.2	45	4590								
Trim	6LBNLI	15	2027	0-60	1639	99.8	55	459								
Lumens	1642	25	973	0-90	1642	100	65	311								
Efficacy	75.3 Lm/W	35	412	90-180	0	0	75	0								
SC	0.53	45	59	0-180	1642	100	85	0								
UGR	0	55	5													
		65	2													
		75	0													
		85	0													
		90	0													

Photometric Data

[View IES files](#)

SHALLOW 85° BEAM (H)		CANDLEPOWER DISTRIBUTION				CONE OF LIGHT				CANDELA TABLE		ZONAL LUMEN SUMMARY			LUMINANCE	
Test Number	P571662									Degrees Vertical	Canдела	Zone	Lumens	% Fixture	Average Candela Degrees	Average 0° Luminance
Housing	LDRT6C20D010									0	1125	0-30	790	36.7	37	45292
Module	EU6C10259035	5	1116	0-40	1224	56.9	45	40764								
Trim	6LBSH	15	1021	0-60	1936	90	55	32821								
Lumens	2151	25	864	0-90	2151	100	65	21818								
Efficacy	98.7 Lm/W	35	694	90-180	0	0	75	8536								
SC	1.06	45	526	0-180	2151	100	85	0								
UGR	24.9	55	343													
		65	168													
		75	40													
		85	0													
		90	0													



SHALLOW 70° BEAM (LI)		CANDLEPOWER DISTRIBUTION				CONE OF LIGHT				CANDELA TABLE		ZONAL LUMEN SUMMARY			LUMINANCE	
Test Number	P571663									Degrees Vertical	Canдела	Zone	Lumens	% Fixture	Average Candela Degrees	Average 0° Luminance
Housing	LDRT6C20D010									0	1405	0-30	879	39.5	37	45256
Module	EU6C10259035	5	1383	0-40	1315	59.1	45	40516								
Trim	6LBSLI	15	1175	0-60	2019	90.7	55	32324								
Lumens	2226	25	913	0-90	2226	100	65	21170								
Efficacy	102.1 Lm/W	35	695	90-180	0	0	75	8006								
SC	0.91	45	523	0-180	2226	100	85	0								
UGR	24.6	55	338													
		65	163													
		75	38													
		85	0													
		90	0													



WIDE 80° BEAM (H)		CANDLEPOWER DISTRIBUTION				CONE OF LIGHT				CANDELA TABLE		ZONAL LUMEN SUMMARY			LUMINANCE	
Test Number	P571664									Degrees Vertical	Canдела	Zone	Lumens	% Fixture	Average Candela Degrees	Average 0° Luminance
Housing	LDRT6C20D010									0	1127	0-30	851	46.6	37	47030
Module	EU6C10259035	5	1122	0-40	1312	71.8	45	31934								
Trim	6LBWH	15	1072	0-60	1770	96.9	55	14260								
Lumens	1827	25	968	0-90	1827	100	65	5228								
Efficacy	83.8 Lm/W	35	746	90-180	0	0	75	2499								
SC	1.16	45	412	0-180	1827	100	85	1510								
UGR	17.8	55	149													
		65	40													
		75	12													
		85	2													
		90	0													

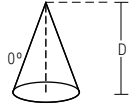
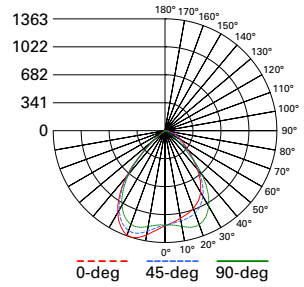

WIDE 80° BEAM (LI)		CANDLEPOWER DISTRIBUTION				CONE OF LIGHT				CANDELA TABLE		ZONAL LUMEN SUMMARY			LUMINANCE	
Test Number	P571665									Degrees Vertical	Canдела	Zone	Lumens	% Fixture	Average Candela Degrees	Average 0° Luminance
Housing	LDRT6C20D010									0	1304	0-30	1074	51.4	37	58990
Module	EU6C10259035	5	1311	0-40	1657	79.4	45	33942								
Trim	6LBWLI	15	1339	0-60	2075	99.4	55	7235								
Lumens	2087	25	1249	0-90	2087	100	65	921								
Efficacy	95.7 Lm/W	35	946	90-180	0	0	75	508								
SC	1.24	45	438	0-180	2087	100	85	0								
UGR	10.8	55	76													
		65	7													
		75	2													
		85	0													
		90	0													

Photometric Data

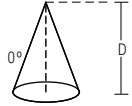
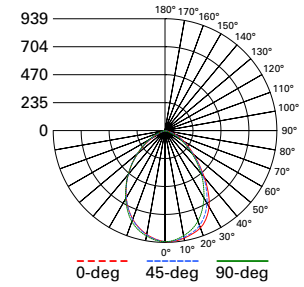
 View IES files

SINGLE WALL WASH (LI)		CANDLEPOWER DISTRIBUTION		CONE OF LIGHT		CANDELA TABLE		ZONAL LUMEN SUMMARY			LUMINANCE																									
Test Number	P571666	Downlight				Degrees Vertical	Candela	Zone	Lumens	% Fixture	Average Candela Degrees	Average 0° Luminance																								
Housing	LDRT6C20D010			<table border="1"> <thead> <tr> <th>D</th> <th>FC</th> <th>L</th> <th>W</th> </tr> </thead> <tbody> <tr><td>4'</td><td>7.7</td><td>4.7</td><td>4.8</td></tr> <tr><td>7'</td><td>25.1</td><td>8.2</td><td>8.6</td></tr> <tr><td>9'</td><td>15.2</td><td>10.6</td><td>11.2</td></tr> <tr><td>13'</td><td>7.3</td><td>15.3</td><td>16</td></tr> <tr><td>16'</td><td>4.8</td><td>18.9</td><td>19.8</td></tr> </tbody> </table>		D	FC	L	W	4'	7.7	4.7	4.8	7'	25.1	8.2	8.6	9'	15.2	10.6	11.2	13'	7.3	15.3	16	16'	4.8	18.9	19.8	0	1155	0-30	971	46	37	47358
D	FC	L	W																																	
4'	7.7	4.7	4.8																																	
7'	25.1	8.2	8.6																																	
9'	15.2	10.6	11.2																																	
13'	7.3	15.3	16																																	
16'	4.8	18.9	19.8																																	
Module	EU6C10259035					5	1121	0-40	1515	71.7	45	36399																								
Trim	6LBSWNL1					15	1048	0-60	2008	95.1	55	26819																								
Lumens	2112					25	949	0-90	2112	100	65	23491																								
Efficacy	96.9 Lm/W					35	746	90-180	0	0	75	17305																								
SC	1.29					45	470	0-180	2112	100	85	11133																								
UGR	25.8					55	281																													
						65	181																													
						75	82																													
						85	18																													
						90	0																													

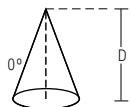
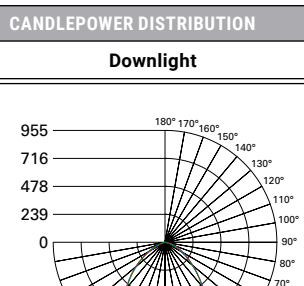
LENSED WALL WASH (H)		CANDLEPOWER DISTRIBUTION		CONE OF LIGHT		CANDELA TABLE		ZONAL LUMEN SUMMARY			LUMINANCE																									
Test Number	P571667	Downlight				Degrees Vertical	Candela	Zone	Lumens	% Fixture	Average Candela Degrees	Average 0° Luminance																								
Housing	LDRT6C20D010			<table border="1"> <thead> <tr> <th>D</th> <th>FC</th> <th>L</th> <th>W</th> </tr> </thead> <tbody> <tr><td>4'</td><td>58.6</td><td>4.4</td><td>4.2</td></tr> <tr><td>7'</td><td>19.1</td><td>7.8</td><td>7.4</td></tr> <tr><td>9'</td><td>11.6</td><td>10.1</td><td>9.6</td></tr> <tr><td>13'</td><td>5.5</td><td>14.5</td><td>14</td></tr> <tr><td>16'</td><td>3.7</td><td>17.9</td><td>17.2</td></tr> </tbody> </table>		D	FC	L	W	4'	58.6	4.4	4.2	7'	19.1	7.8	7.4	9'	11.6	10.1	9.6	13'	5.5	14.5	14	16'	3.7	17.9	17.2	0	937	0-30	682	40	37	40857
D	FC	L	W																																	
4'	58.6	4.4	4.2																																	
7'	19.1	7.8	7.4																																	
9'	11.6	10.1	9.6																																	
13'	5.5	14.5	14																																	
16'	3.7	17.9	17.2																																	
Module	EU6C10259035					5	936	0-40	1049	61.6	45	32321																								
Trim	6LBSWWH					15	902	0-60	1561	91.6	55	24315																								
Lumens	1704					25	824	0-90	1704	100	65	18705																								
Efficacy	78.2 Lm/W					35	642	90-180	0	0	75	12878																								
SC	1.08					45	417	0-180	1704	100	85	3585																								
UGR	25					55	254																													
						65	144																													
						75	61																													
						85	6																													
						90	0																													

LENSED WALL WASH (LI)		CANDLEPOWER DISTRIBUTION		CONE OF LIGHT		CANDELA TABLE		ZONAL LUMEN SUMMARY			LUMINANCE																									
Test Number	P571668	Downlight				Degrees Vertical	Candela	Zone	Lumens	% Fixture	Average Candela Degrees	Average 0° Luminance																								
Housing	LDRT6C20D010			<table border="1"> <thead> <tr> <th>D</th> <th>FC</th> <th>L</th> <th>W</th> </tr> </thead> <tbody> <tr><td>4'</td><td>59.6</td><td>4.6</td><td>4.2</td></tr> <tr><td>7'</td><td>19.5</td><td>8</td><td>7.6</td></tr> <tr><td>9'</td><td>11.8</td><td>10.3</td><td>9.8</td></tr> <tr><td>13'</td><td>5.6</td><td>14.9</td><td>14.2</td></tr> <tr><td>16'</td><td>3.7</td><td>18.5</td><td>17.4</td></tr> </tbody> </table>		D	FC	L	W	4'	59.6	4.6	4.2	7'	19.5	8	7.6	9'	11.8	10.3	9.8	13'	5.6	14.9	14.2	16'	3.7	18.5	17.4	0	953	0-30	712	40.6	37	40426
D	FC	L	W																																	
4'	59.6	4.6	4.2																																	
7'	19.5	8	7.6																																	
9'	11.8	10.3	9.8																																	
13'	5.6	14.9	14.2																																	
16'	3.7	18.5	17.4																																	
Module	EU6C10259035					5	936	0-40	1094	62.4	45	31833																								
Trim	6LBSWWLI					15	896	0-60	1620	92.4	55	23961																								
Lumens	1753					25	822	0-90	1753	100	65	18497																								
Efficacy	80.4 Lm/W					35	638	90-180	0	0	75	12942																								
SC	1.1					45	411	0-180	1753	100	85	3585																								
UGR	24.8					55	251																													
						65	143																													
						75	61																													
						85	6																													
						90	0																													

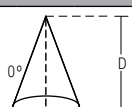
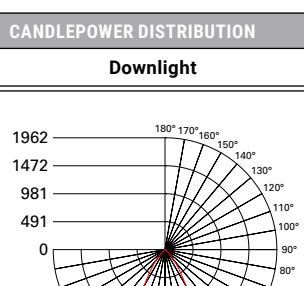
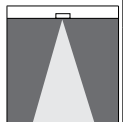
MEDIUM BEAM 45° CUTOFF 50° BEAM (H)		CANDLEPOWER DISTRIBUTION		CONE OF LIGHT		CANDELA TABLE		ZONAL LUMEN SUMMARY			LUMINANCE																									
Test Number	P571669	Downlight				Degrees Vertical	Candela	Zone	Lumens	% Fixture	Average Candela Degrees	Average 0° Luminance																								
Housing	LDRT6C20D010			<table border="1"> <thead> <tr> <th>D</th> <th>FC</th> <th>L</th> <th>W</th> </tr> </thead> <tbody> <tr><td>4'</td><td>122.6</td><td>3.2</td><td>3.2</td></tr> <tr><td>7'</td><td>40</td><td>5.6</td><td>5.6</td></tr> <tr><td>9'</td><td>24.2</td><td>7.2</td><td>7.2</td></tr> <tr><td>13'</td><td>11.6</td><td>10.4</td><td>10.4</td></tr> <tr><td>16'</td><td>7.7</td><td>12.8</td><td>12.8</td></tr> </tbody> </table>		D	FC	L	W	4'	122.6	3.2	3.2	7'	40	5.6	5.6	9'	24.2	7.2	7.2	13'	11.6	10.4	10.4	16'	7.7	12.8	12.8	0	1962	0-30	1072	71.8	37	24203
D	FC	L	W																																	
4'	122.6	3.2	3.2																																	
7'	40	5.6	5.6																																	
9'	24.2	7.2	7.2																																	
13'	11.6	10.4	10.4																																	
16'	7.7	12.8	12.8																																	
Module	EU6C10259035					5	1894	0-40	1351	90.5	45	9900																								
Trim	6LBMDH					15	1517	0-60	1480	99.1	55	2542																								
Lumens	1493					25	1052	0-90	1493	100	65	1180																								
Efficacy	68.5 Lm/W					35	437	90-180	0	0	75	635																								
SC	0.8					45	128	0-180	1493	100	85	252																								
UGR	7.6					55	27																													
						65	9																													
						75	3																													
						85	0																													
						90	0																													

Photometric Data

[View IES files](#)

MEDIUM BEAM 45° CUTOFF 50° BEAM (LI)	CANDLEPOWER DISTRIBUTION	CONE OF LIGHT	CANDELA TABLE	ZONAL LUMEN SUMMARY	LUMINANCE																																																											
Test Number P571670 Housing LDRT6C20D010 Module EU6C10259035 Trim 6LBMDLI Lumens 1549 Efficacy 71.1 Lm/W SC 0.76 UGR 0	Downlight 		<table border="1"> <thead> <tr> <th>Degrees Vertical</th> <th>Candela</th> </tr> </thead> <tbody> <tr><td>0</td><td>2314</td></tr> <tr><td>5</td><td>2309</td></tr> <tr><td>15</td><td>1837</td></tr> <tr><td>25</td><td>1109</td></tr> <tr><td>35</td><td>371</td></tr> <tr><td>45</td><td>65</td></tr> <tr><td>55</td><td>6</td></tr> <tr><td>65</td><td>2</td></tr> <tr><td>75</td><td>1</td></tr> <tr><td>85</td><td>0</td></tr> <tr><td>90</td><td>0</td></tr> </tbody> </table>	Degrees Vertical	Candela	0	2314	5	2309	15	1837	25	1109	35	371	45	65	55	6	65	2	75	1	85	0	90	0	<table border="1"> <thead> <tr> <th>Zone</th> <th>Lumens</th> <th>% Fixture</th> </tr> </thead> <tbody> <tr><td>0-30</td><td>1230</td><td>79.4</td></tr> <tr><td>0-40</td><td>1486</td><td>95.9</td></tr> <tr><td>0-60</td><td>1546</td><td>99.8</td></tr> <tr><td>0-90</td><td>1549</td><td>100</td></tr> <tr><td>90-180</td><td>0</td><td>0</td></tr> <tr><td>0-180</td><td>1549</td><td>100</td></tr> </tbody> </table>	Zone	Lumens	% Fixture	0-30	1230	79.4	0-40	1486	95.9	0-60	1546	99.8	0-90	1549	100	90-180	0	0	0-180	1549	100	<table border="1"> <thead> <tr> <th>Average Candela Degrees</th> <th>Average 0° Luminance</th> </tr> </thead> <tbody> <tr><td>37</td><td>18792</td></tr> <tr><td>45</td><td>5032</td></tr> <tr><td>55</td><td>535</td></tr> <tr><td>65</td><td>259</td></tr> <tr><td>75</td><td>169</td></tr> <tr><td>85</td><td>0</td></tr> </tbody> </table>	Average Candela Degrees	Average 0° Luminance	37	18792	45	5032	55	535	65	259	75	169	85	0
Degrees Vertical	Candela																																																															
0	2314																																																															
5	2309																																																															
15	1837																																																															
25	1109																																																															
35	371																																																															
45	65																																																															
55	6																																																															
65	2																																																															
75	1																																																															
85	0																																																															
90	0																																																															
Zone	Lumens	% Fixture																																																														
0-30	1230	79.4																																																														
0-40	1486	95.9																																																														
0-60	1546	99.8																																																														
0-90	1549	100																																																														
90-180	0	0																																																														
0-180	1549	100																																																														
Average Candela Degrees	Average 0° Luminance																																																															
37	18792																																																															
45	5032																																																															
55	535																																																															
65	259																																																															
75	169																																																															
85	0																																																															
		<table border="1"> <thead> <tr> <th>D</th> <th>FC</th> <th>L</th> <th>W</th> </tr> </thead> <tbody> <tr><td>4'</td><td>144.6</td><td>3</td><td>3</td></tr> <tr><td>7'</td><td>47.2</td><td>5.2</td><td>5.2</td></tr> <tr><td>9'</td><td>28.6</td><td>6.8</td><td>6.8</td></tr> <tr><td>13'</td><td>13.7</td><td>9.8</td><td>9.8</td></tr> <tr><td>16'</td><td>9</td><td>12</td><td>12</td></tr> </tbody> </table>	D	FC	L	W	4'	144.6	3	3	7'	47.2	5.2	5.2	9'	28.6	6.8	6.8	13'	13.7	9.8	9.8	16'	9	12	12																																						
D	FC	L	W																																																													
4'	144.6	3	3																																																													
7'	47.2	5.2	5.2																																																													
9'	28.6	6.8	6.8																																																													
13'	13.7	9.8	9.8																																																													
16'	9	12	12																																																													

Photometric Multipliers (Nominal Lumen Values)

250 Lumen	500 Lumen	800 Lumen	1000 Lumen	1500 Lumen	2000 Lumen	2500 Lumen	3000 Lumen	3500 Lumen
0.17	0.33	0.44	0.51	0.78	1.00	1.26	1.48	1.74

4000 Lumen	4500 Lumen	5000 Lumen	5500 Lumen	6000 Lumen	6500 Lumen	7000 Lumen	7500 Lumen	8000 Lumen
2.02	2.34	2.65	2.96	3.20	3.35	3.52	4.14	4.47

9000 Lumen	10000 Lumen	11000 Lumen	12000 Lumen	13000 Lumen
4.76	5.09	5.87	6.33	6.96

Multipliers for relative lumen values with other series models.

CCT Multipliers – 90CRI

2400K	2700K	3000K	3500K	4000K	5000K
0.912	0.949	0.986	1	1.001	1.022

Multipliers for relative lumen values with other series color temperatures.

CCT Multipliers – 97CRI

2700K	3000K	3500K	4000K	5000K
0.889	0.955	1	1.016	1.07

Multipliers for relative lumen values with other series color temperatures.

Color Finish Multipliers

Finish code	LI	H	WMH	WH	GPH	B	MW
Finish	Specular Clear	Semi-Specular Clear	Warm Haze	Wheat	Graphite Haze	Specular Black	Matte White
Multiplier	1.22	1	1.07	1.07	0.76	0.59	1.09

Multipliers for relative lumen values with other color finishes.

Photometric Data

[View IES files](#)

WALL WASH	
Test Number	P563510
Housing	LDRT6C20D010
Module	EU6209035
Trim	6LBLWWH
Lumens	1704
Efficacy	78.2 Lm/W
SC	1.08
UGR	0

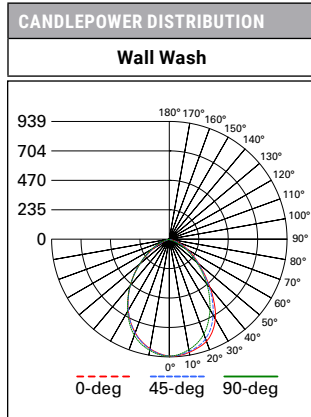
CANDELA TABLE	
Degrees Vertical	Candela
0	937
5	936
15	902
25	824
35	642
45	417
55	254
65	144
75	61
85	6
90	0

ZONAL LUMEN SUMMARY		
Zone	Lumens	% Fixture
0-30	682	40
0-40	1049	61.6
0-60	1561	91.6
0-90	1704	100
90-180	0	0
0-180	1704	100

LUMINANCE	
Average Candela Degrees	Average 0° Luminance
37	40857
45	32321
55	24315
65	18705
75	12878
85	3585

Single Unit Footcandles 3" from wall (distance from fixture along wall)					
DD	•	1'	2'	3'	
1'	8.3	6.4	3.3	1.3	
2'	15.2	12.5	7.5	3.8	
3'	16.4	14	9.2	5.3	
4'	14.4	12.7	9.1	5.7	
5'	11	10.1	7.8	5.3	
6'	8	7.5	6.2	4.6	
7'	5.7	5.5	4.7	3.8	
8'	4.2	4	3.6	3	
9'	3.1	3	2.8	2.4	
10'	2.4	2.3	2.2	1.9	

Multiple Unit Footcandles 3" from wall (spacing between fixtures)					
•	-- 3' --	•	•	-- 4' --	•
9.6	9.5	9.6	8.8	6.5	8.8
19.1	20.1	19.1	17.1	15.1	17.1
21.6	23.3	21.6	19.2	18.4	19.2
20	21.9	20	17.7	18.1	17.7
16.4	18.1	16.4	14.4	15.6	14.4
12.6	13.8	12.6	11.2	12.4	11.2
9.5	10.3	9.5	8.5	9.5	8.5
7.2	7.7	7.2	6.6	7.2	6.6
5.5	5.9	5.5	5.1	5.6	5.1
4.3	4.5	4.3	4	4.3	4

WALL WASH	
Test Number	P563511
Housing	LDRT6C20D010
Module	EU6209035
Trim	6LBLWWLI
Lumens	1753
Efficacy	80.4 Lm/W
SC	1.1
UGR	0

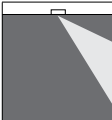
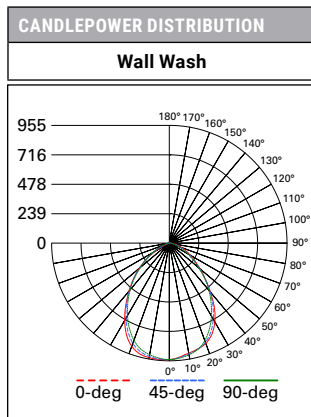
CANDELA TABLE	
Degrees Vertical	Candela
0	953
5	936
15	896
25	822
35	638
45	411
55	251
65	143
75	61
85	6
90	0

ZONAL LUMEN SUMMARY		
Zone	Lumens	% Fixture
0-30	712	40.6
0-40	1094	62.4
0-60	1620	92.4
0-90	1753	100
90-180	0	0
0-180	1753	100

LUMINANCE	
Average Candela Degrees	Average 0° Luminance
37	40426
45	31833
55	23961
65	18497
75	12942
85	3585

Single Unit Footcandles 3" from wall (distance from fixture along wall)					
DD	•	1'	2'	3'	
1'	8.3	6.4	3.2	1.3	
2'	15.1	12.5	7.5	3.8	
3'	16.1	13.9	9.2	5.3	
4'	14.2	12.6	9.1	5.7	
5'	10.9	10	7.8	5.4	
6'	7.9	7.5	6.2	4.6	
7'	5.7	5.5	4.8	3.8	
8'	4.2	4	3.6	3	
9'	3.1	3	2.8	2.4	
10'	2.3	2.3	2.2	1.9	

Multiple Unit Footcandles 3" from wall (spacing between fixtures)					
•	-- 3' --	•	•	-- 4' --	•
9.5	9.5	9.5	8.7	6.4	8.7
18.9	20	18.9	16.9	15.1	16.9
21.4	23.2	21.4	19	18.4	19
19.9	21.9	19.9	17.6	18.1	17.6
16.3	18	16.3	14.4	15.6	14.4
12.6	13.8	12.6	11.2	12.4	11.2
9.5	10.3	9.5	8.5	9.5	8.5
7.2	7.7	7.2	6.6	7.3	6.6
5.5	5.9	5.5	5.1	5.6	5.1
4.3	4.5	4.3	4	4.3	4

Photometric Data

[View IES files](#)

WALL WASH	
Test Number	P563508
Housing	LDRT6C20D010
Module	EU6209035
Trim	6LBSWH
Lumens	1909
Efficacy	87.6 Lm/W
SC	1.18
UGR	0

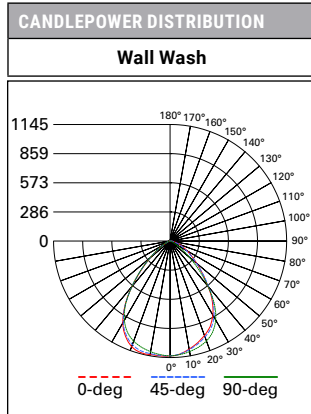
CANDELA TABLE	
Degrees Vertical	Candela
0	1138
5	1123
15	1046
25	937
35	728
45	451
55	257
65	139
75	52
85	11
90	0

ZONAL LUMEN SUMMARY		
Zone	Lumens	% Fixture
0-30	868	45.5
0-40	1335	69.9
0-60	1817	95.2
0-90	1909	100
90-180	0	0
0-180	1909	100

LUMINANCE	
Average Candela Degrees	Average 0° Luminance
37	46298
45	34942
55	24563
65	18005
75	11056
85	6919

Single Unit Footcandles 3" from wall (distance from fixture along wall)				
DD	•	1'	2'	3'
1'	7.6	5.9	3.1	1.2
2'	15.3	12.5	7.6	3.7
3'	17.7	15	9.9	5.4
4'	16.3	14.3	10.2	6.2
5'	12.5	11.5	9.1	6.2
6'	9	8.6	7.3	5.6
7'	6.5	6.3	5.6	4.6
8'	4.8	4.6	4.2	3.7
9'	3.6	3.5	3.2	2.9
10'	2.7	2.6	2.5	2.3

Multiple Unit Footcandles 3" from wall (spacing between fixtures)					
•	-- 3' --	•	•	-- 4' --	•
8.8	8.9	8.8	8	6.1	8
19	20.1	19	16.9	15.1	16.9
23.1	25	23.1	20.3	19.7	20.3
22.5	24.8	22.5	19.7	20.4	19.7
18.7	21	18.7	16.3	18.3	16.3
14.6	16	14.6	12.8	14.6	12.8
11.1	11.9	11.1	10	11.2	10
8.4	8.9	8.4	7.7	8.5	7.7
6.4	6.7	6.4	6	6.5	6
5	5.2	5	4.7	5	4.7

WALL WASH	
Test Number	P563509
Housing	LDRT6C20D010
Module	EU6209035
Trim	6LBSWLI
Lumens	2112
Efficacy	96.9 Lm/W
SC	1.29
UGR	0

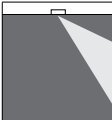
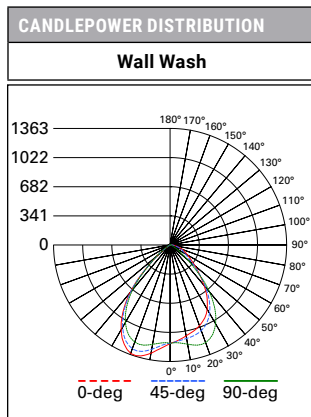
CANDELA TABLE	
Degrees Vertical	Candela
0	1155
5	1121
15	1048
25	949
35	746
45	470
55	281
65	181
75	82
85	18
90	0

ZONAL LUMEN SUMMARY		
Zone	Lumens	% Fixture
0-30	971	46
0-40	1515	71.7
0-60	2008	95.1
0-90	2112	100
90-180	0	0
0-180	2112	100

LUMINANCE	
Average Candela Degrees	Average 0° Luminance
37	47358
45	36399
55	26819
65	23491
75	17305
85	11133

Single Unit Footcandles 3" from wall (distance from fixture along wall)				
DD	•	1'	2'	3'
1'	11	8.7	4.6	1.9
2'	16.9	13.8	8.5	4.4
3'	18.4	15.7	10	5.2
4'	16.6	14.8	10.7	6.3
5'	12.7	11.7	9.5	6.6
6'	9.2	8.7	7.6	5.9
7'	6.6	6.3	5.8	4.9
8'	4.8	4.7	4.4	3.9
9'	3.6	3.5	3.4	3.1
10'	2.7	2.7	2.6	2.4

Multiple Unit Footcandles 3" from wall (spacing between fixtures)					
•	-- 3' --	•	•	-- 4' --	•
12.9	13.1	12.9	11.8	9.2	11.8
21.3	22.4	21.3	19	17	19
23.6	25.8	23.6	21	20	21
22.9	25.9	22.9	19.9	21.5	19.9
19.3	21.6	19.3	16.6	19.1	16.6
15.1	16.5	15.1	13.3	15.2	13.3
11.4	12.2	11.4	10.3	11.6	10.3
8.7	9.1	8.7	8	8.8	8
6.6	6.9	6.6	6.2	6.7	6.2
5.2	5.3	5.2	4.9	5.2	4.9

Multi-line Order Information

SAMPLE ORDER NUMBER: **LDRT6C10D010TREM14**

Invoice will indicate separate fixture components (housing, trim, module) and may ship from multiple CLS facilities in separate cartons.

 **Single line Ordering Information Option**

Domestic Preferences ⁽¹⁾	Housing	Lumens ⁽²⁾			
[Blank] =Standard TAA =Trade Agreements Act	LDRT6C =LED Downlight Retrofit for 6" to 6-7/16" or 8-9/16" with ABR8P openings LDRT6CCP =LED Downlight Retrofit for 6" to 6-7/16" or 8-9/16" with ABR8P openings, Chicago Plenum LDRT67C =LED Downlight Retrofit for 6-1/2" to 7-1/2" openings ⁽²¹⁾ LDRT67CCP =LED Downlight Retrofit for 6-1/2" to 7-1/2" openings, Chicago Plenum ⁽²¹⁾	02 =250 lumens 05 =500 lumens 08 =800 lumens 10 =1000 lumens 15 =1500 lumens 20 =2000 lumens	25 =2500 lumens 30 =3000 lumens 35 =3500 lumens 40 =4000 lumens 45 =4500 lumens ⁽³⁾ 50 =5000 lumens ⁽³⁾	55 =5500 lumens ⁽³⁾ 60 =6000 lumens ⁽³⁾ 65 =6500 lumens ⁽³⁾ 70 =7000 lumens ⁽³⁾ 75 =7500 lumens ⁽³⁾ 80 =8000 Lumens ⁽³⁾	90 =9000 Lumens ⁽³⁾ 100 =10,000 Lumens ⁽³⁾ 110 =11,000 Lumens ⁽³⁾ 120 =12,000 Lumens ⁽³⁾ 130 =13,000 Lumens ⁽³⁾ 150 =15,000 Lumens ⁽³⁾

Driver	Driver Options
D010 = 0-10V Dimming, 1% to 100%, 120V-277V, up to 7000 lumens (up to 3000 lumens for remote driver) 1D010 = 0-10V Dimming, 1% to 100%, 120V, 7500 lumens and above (3500 to 7000 lumens for remote driver) 2D010 = 0-10V Dimming, 1% to 100%, 277V, 7500 lumens and above (3500 to 7000 lumens for remote driver) 3D010 = 0-10V Dimming, 1% to 100%, 347V dedicated drivers for 800 to 4000 lumens; 250, 500, 4500 and above use step down transformer (250 to 7000 lumens for remote driver) 1 driver: 250-7000 / 2 drivers: 7500-12,000 / 3 drivers: 13,000-15,000	Blank =Integral driver R =Remote driver (offered with single driver, order remote driver separately) ⁽⁶⁾ PD =Plug in Driver (offered with single driver) ⁽⁶⁾
D010TR =0-10V (120-277V) or Line Voltage (120V) dimming, 5-100%, 250- 4500 lumens (up to 3000 lumens for remote driver) 1D010TR =0-10V or Line Voltage Dimming, 5% to 100%, 120V, 5000-9000 & 13,000 lumens (3500 to 4500 lumens for remote driver) 2D010TR =0-10V Dimming, 5% to 100%, 277V, 5000-9000 & 13,000 lumens (3500 to 4500 lumens for remote driver) 3D010TR =0-10V Dimming, 5% to 100%, 347V step down transformer, 250-9000 & 13,000 lumens (250 to 4500 lumens for remote driver) 1 driver: 250-4500 / 2 drivers: 5000-9000 / 3 drivers: 13,000	
DE010 = 0-10V Dimming, 0% to 100%, 120V-277V, 500-7000 lumens (up to 3000 lumens for remote driver) 1DE010 = 0-10V Dimming, 0% to 100%, 120V, 7500 lumens and above (3500 to 7000 lumens for remote driver) 2DE010 = 0-10V Dimming, 0% to 100%, 277V, 7500 lumens and above (3500 to 7000 lumens for remote driver) 3DE010 = 0-10V Dimming, 0% to 100%, 0-10V Dimming, 347V step down transformer, 500-15,000 lumens (500 to 7000 lumens for remote driver) 1 driver: 500-7000 / 2 drivers: 7500-12,000 / 3 drivers: 13,000-15,000	
D5LT = Fifth Light® (DALI T6) Logarithmic Dimming, 0% to 100%, 120V-277V, 500-7000 lumens (up to 3000 lumens for remote driver) 1D5LT = Fifth Light® (DALI T6) Logarithmic Dimming, 0% to 100%, 120V, 7500 lumens and above (3500 to 7000 lumens for remote driver) 2D5LT =Fifth Light® (DALI T6) Logarithmic Dimming, 0% to 100%, 277V, 7500 lumens and above (3500 to 7000 lumens for remote driver) 3D5LT =Fifth Light® (DALI T6) Logarithmic Dimming, 0% to 100% 347V step down transformer, 500-15,000 lumens (500 to 7000 lumens for remote driver) 1 driver: 500-7000 / 2 drivers: 7500-12,000 / 3 drivers: 13,000-15,000	
DMX =DMX/RDM Logarithmic Dimming, 0% to 100%, 120V-277V, 800-4500 lumens (up to 3000 lumens for remote driver) (up to 3000 lumens for remote driver) ⁽⁵⁾ 1DMX =DMX/RDM Logarithmic Dimming, 0% to 100%, 120V, 5000-9000 and 13,000 lumens (3500 to 4500 lumens for remote driver) (3500 to 4500 lumens for remote driver) ⁽⁵⁾ 2DMX =DMX/RDM Logarithmic Dimming, 0% to 100%, 277V, 5000-9000 and 13,000 lumens (3500 to 4500 lumens for remote driver) (3500 to 4500 lumens for remote driver) ⁽⁵⁾ 3DMX =DMX/RDM Logarithmic Dimming, 0% to 100%, 347V step down transformer, 800-9000 and 13,000 lumens, RJ45 Connection (800 to 4500 lumens for remote driver) ⁽⁵⁾ 1 driver: 800-4500 / 2 drivers: 5000-9000 / 3 drivers: 13,000	
DMXC5 =DMX/RDM Logarithmic Dimming, 0% to 100%, 120V-277V, up to 800-4500 lumens, RJ45 Connection (up to 3000 lumens for remote driver) ⁽⁵⁾ 1DMXC5 =DMX/RDM Logarithmic Dimming, 0% to 100%, 120V, 5000-9000 and 13,000 lumens, RJ45 Connection (3500 to 4500 lumens for remote driver) ⁽⁵⁾ 2DMXC5 =DMX/RDM Logarithmic Dimming, 0% to 100%, 277V, 5000-9000 and 13,000 lumens, RJ45 Connection (3500 to 4500 lumens for remote driver) ⁽⁵⁾ 3DMXC5 =DMX/RDM Logarithmic Dimming, 0% to 100%, 347V step down transformer, 250-9000 and 13,000 lumens, RJ45 Connection (800 to 4500 lumens for remote driver) ⁽⁵⁾ 1 driver: 800-4500 / 2 drivers: 5000-9000 / 3 drivers: 13,000	
1DL2 =Lutron® Hi-Lume Forward Phase Dimming, 1% to 100%, 120V Only, 800-7500 lumens (800 to 3500 lumens for remote driver) 3DL2 = Lutron® Hi-Lume Forward Phase Dimming, 1% to 100%, 347V step down transformer, 800-7500 lumens (800 to 3500 lumens for remote driver) 1 driver: 800-3500 / 2 drivers: 4000-7500	
DLE =Lutron Ecosystem dimming 1% to 100%, 120V-277V, 800-3500 lumens (up to 3000 lumens for remote driver) 1DLE =Lutron Ecosystem dimming 1% to 100%, 120V, 4000-7500 lumens (3500 lumens for remote driver) 2DLE =Lutron Ecosystem dimming 1% to 100%, 277V, 4000-7500 lumens (3500 lumens for remote driver) 3DLE =Lutron Ecosystem dimming 1% to 100%, 347V step down transformer, 800-7500 lumens (800-3500 lumens for remote driver) 1 driver: 800-3500 / 2 drivers: 4000-7500	
DLV =Low voltage dimming driver (1-100%) for use with DLVP system 800-3000 lumens ⁽⁶⁾	

Driver Options	Options ⁽⁶⁾ ⁽²⁷⁾ ⁽²⁸⁾ ⁽³⁰⁾
Blank =Integral driver R =Remote driver (order remote driver separately) PD =Plug in Driver ⁽⁶⁾	EMBOD =Bodine® Emergency Module with Remote Test Switch ⁽¹⁰⁾ EMBOD6ST =Bodine® 6W Self Test Emergency Module with Remote Test Switch EM7 =7W Emergency Module with Remote Test Switch EM14 =14W Emergency Module with Remote Test Switch EMBOD7ST =Bodine® Self Test Emergency Module ⁽¹⁰⁾ EMV7 =7W Low Voltage Emergency Module with Remote Test Switch ⁽⁷⁾ EMV14 =14W Low Voltage Emergency Module with Remote Test Switch ⁽⁷⁾ ETRD =Emergency transfer device ⁽²⁹⁾ WPST =Factory installed Wavelinx (includes control module, sensor, cable, tilemount and ceiling mount sensor) ⁽¹¹⁾ ⁽¹³⁾ WLST =Factory installed Wavelinx LITE Sensor Kit ⁽¹¹⁾ ⁽¹²⁾ WPN = Wavelinx PRO Wireless Node without sensor ⁽³¹⁾

Continued on next page.

Multi-line Order Information

SAMPLE ORDER NUMBER: **EU6C10259035**

Domestic Preferences ⁽¹⁾	Power Module	Lumen Levels ⁽²⁾	CRI ⁽²⁾	Color
[Blank] =Standard TAA =Trade Agreements Act	EU6C =6-inch Universal LED Module	<p>For use with one driver</p> <p>02081C=250, 500, 800 lumens, IC Rated (for use with all drivers, min 500 lumen with DE010 and D5LT, min 800 lumens with DLVP, Lutron and DMX)</p> <p>1025= 1000, 1500, 2000, 2500 lumens</p> <p>10151C=1000, 1500 lumens IC Rated</p> <p>3040=3000, 3500, 4000 lumens (For use with Lutron 3000-3500, DLVP 3000 lumens, DMX, D010, D010TR, D5LT and DE010 3000-4000)</p> <p>4560=4500, 5000, 5500, 6000 lumens (For use with DMX and D010TR 4500 lumens, D010, D5LT and DE010 4500-6000) ⁽³⁾</p> <p>6570=6500, 7000 lumens (For use with D010, D5LT and DE010) ⁽³⁾</p> <p>For use with two drivers</p> <p>4080=4000, 4500, 5000, 5500, 6000, 6500, 7000, 7500, 8000 lumens (For use with Lutron 4000-7500, D010TR & DMX 5000-8000, D010, D5LT & DE010 7500-8000 lumen) ⁽³⁾</p> <p>90120=9000, 10000, 11000, 12000 lumens (D010, D5LT, DE010 to 9000-12,000 lumens, DMX and D010TR 9000 lumens) ⁽³⁾</p> <p>For use with three drivers</p> <p>130150=13,000, 15000 lumens (D010, DE010, D5LT, 13,000-15,000 lumens, D010TR and DMX 13,000 lumens) ⁽³⁾</p>	<p>90=90 CRI Minimum</p> <p>97=97 CRI Minimum</p>	<p>90 CRI</p> <p>24=2400K</p> <p>27=2700K</p> <p>30=3000K</p> <p>35=3500K</p> <p>40=4000K</p> <p>50=5000K</p>

SAMPLE ORDER NUMBER: **6LBM2H**

Trim	Reflector	Flange	Finish	
6LB =6-inch LED	<p>N=Narrow, Spun Aluminum ⁽⁸⁾</p> <p>M=50° Cutoff, Medium Beam Reflector, Spun Aluminum</p> <p>MD=45° Cutoff, Medium Beam Reflector, Spun Aluminum</p> <p>W=Wide, Spun Aluminum</p> <p>S=Shallow, Spun Aluminum</p> <p>HY=Hyperbolic medium beam ⁽⁸⁾⁽²²⁾</p> <p>PS=Non-Conductive Shallow, Injection Molded white ⁽¹⁶⁾⁽¹⁷⁾</p> <p>CS=Cast Shallow, Die Cast Aluminum</p> <p>BA= Spun Aluminum Baffle ⁽¹⁴⁾</p>	<p>Wall Wash</p> <p>SWN=Single wall wash, spun aluminum</p> <p>DWN=Double wall wash, spun aluminum</p> <p>CW=Corner wall wash, spun aluminum</p> <p>LSWW=Lensed single wall wash, spun aluminum</p> <p>LDWW=Lensed double wall wash, spun aluminum</p>	<p>0=White polymer trim ring</p> <p>1=Self flanged ⁽¹⁸⁾</p> <p>2=White painted self flanged</p>	<p>LI=Specular Clear ⁽¹⁹⁾</p> <p>H=Semi-Specular Clear ⁽¹⁹⁾</p> <p>WMH=Warm Haze ⁽¹⁹⁾</p> <p>WH=Wheat ⁽¹⁹⁾</p> <p>GPH=Graphite Haze ⁽¹⁹⁾</p> <p>B=Specular Black ⁽¹⁹⁾</p> <p>MW=Matte White</p> <p>MB=Matte Black ⁽²⁰⁾</p> <p>MMS=Matte Metallic Silver ⁽²⁰⁾</p>

REQUIRED if Remote Driver (R) is specified

SAMPLE ORDER NUMBER: **RC10010D010TREM7**

Domestic Preferences ⁽¹⁾	Remote Drivers	Lumens ⁽²⁾⁽¹⁴⁾		
[Blank] =Standard TAA =Trade Agreements Act	<p>RC100=Remote 100ft</p> <p>RC75=Remote 75ft</p> <p>RC50=Remote 50ft</p> <p>RC25=Remote 25ft</p> <p>RC15=Remote 15ft</p> <p>RC5=Remote 5ft</p> <p>RC2=Remote 2ft</p>	<p>02=250 lumens</p> <p>05=500 lumens</p> <p>08=800 lumens</p> <p>10=1000 lumens</p> <p>15=1500 lumens</p>	<p>20=2000 lumens</p> <p>25=2500 lumens</p> <p>30=3000 lumens</p> <p>35=3500 lumens</p> <p>40=4000 lumens</p> <p>45=4500 lumens</p>	<p>50=5000 lumens</p> <p>55=5500 lumens</p> <p>60=6000 lumens</p> <p>65=6500 lumens</p> <p>70=7000 lumens</p>

Continued on next page.

Multi-line Order Information

Driver
<p>D010 = 0-10V Dimming, 1% to 100%, 120V-277V, 250-3000 lumens 1D010 = 0-10V Dimming, 1% to 100%, 120V, 3500-7000 lumens 2D010 = 0-10V Dimming, 1% to 100%, 277V, 3500-7000 lumens 3D010 = 0-10V Dimming, 1% to 100%, 347V dedicated drivers for 800 to 3000 lumens; 250, 500, 3500-7000 lumens use step down transformer</p>
<p>D010TR = 0-10V (120-277V) or line voltage (120V) dimming, 5-100%, 250- 3000 lumens 1D010TR = 0-10V or Line Voltage Dimming, 5% to 100%, 120V, 3500-4500 lumens 2D010TR = 0-10V Dimming, 5% to 100%, 277V, 3500-4500 lumens 3D010TR = 0-10V Dimming, 5% to 100% 347V step down transformer, 250-4500 lumens</p>
<p>DE010 = 0-10V Dimming, 0% to 100%, 120V-277V, 500-3000 lumens 1DE010 = 0-10V Dimming, 0% to 100%, 120V, 3500-7,000 lumens 2DE010 = 0-10V Dimming, 0% to 100%, 277V, 3500-7,000 lumens 3DE010 = 0-10V Dimming, 0% to 100%, 347V step down transformer, 500-7,000 lumens</p>
<p>D5LT = Fifth Light® (DALI T6) Logarithmic Dimming, 0% to 100%, 120V-277V, 500-3000 lumens 1D5LT = Fifth Light® (DALI T6) Logarithmic Dimming, 0% to 100%, 120V, 3500-7,000 lumens 2D5LT =Fifth Light® (DALI T6) Logarithmic Dimming, 0% to 100%, 277V, 3500-7,000 lumens 3D5LT =Fifth Light® (DALI T6) Logarithmic Dimming, 0% to 100% 347V step down transformer, 500-7,000 lumens</p>
<p>DMX = DMX/RDM Logarithmic Dimming, 0% to 100%, 120V-277V, 800-3000 lumens⁽⁵⁾ 1DMX=DMX/RDM Logarithmic Dimming, 0% to 100%, 120V, 3500-4500⁽⁵⁾ 2DMX=DMX/RDM Logarithmic Dimming, 0% to 100%, 277V, 3500-4500⁽⁵⁾ 3DMX=DMX/RDM Logarithmic Dimming, 0% to 100%, 347V step down transformer, 800-4500⁽⁵⁾</p>
<p>DMXC5 = DMX/RDM Logarithmic Dimming, 0% to 100%, 120V-277V up to 800-3000 lumens, RJ45 Connection⁽⁵⁾ 1DMXC5=DMX/RDM Logarithmic Dimming, 0% to 100%, 120V, 3500-4500 lumens, RJ45 Connection⁽⁵⁾ 2DMXC5=DMX/RDM Logarithmic Dimming, 0% to 100%, 277V, 3500-4500 lumens, RJ45 Connection⁽⁵⁾ 3DMXC5=DMX/RDM Logarithmic Dimming, 0% to 100%, 347V step down transformer, 800-4500 lumens, RJ45 Connection⁽⁵⁾</p>
<p>1DL2=Lutron® Hi-Lume Forward Phase Dimming, 1% to 100%, 120V Only, 25' Max remote length, 800-3500 lumens 3DL2 = Lutron® Hi-Lume Forward Phase Dimming, 1% to 100%, 347V step down transformer, 25' Max remote length, 800-3500 lumens</p>
<p>DLE = Lutron Ecosystem dimming 1% to 100%, 120V-277V, 25' Max remote length, 800-3000 lumens 1DLE=Lutron Ecosystem dimming 1% to 100%, 120V, 25' Max remote length, 3500 lumens 2DLE=Lutron Ecosystem dimming 1% to 100%, 277V, 25' Max remote length, 3500 lumens 3DLE=Lutron Ecosystem dimming 1% to 100%, 347V, step down transformer, 25' Max remote length, 800-3500 lumens</p>
<p>DLV = Low voltage dimming driver (1-100%) for use with DLVP system, 800-3000 lumens⁽⁶⁾</p>

Options ^{(6) (27) (28) (30)}	Controls
<p>EMBOD=Bodine® Emergency Module with Remote Test Switch⁽¹⁰⁾ EMBOD6ST=Bodine® 6W Self Test Emergency Module with Remote Test Switch EM7=7W Emergency Module with Remote Test Switch EM14=14W Emergency Module with Remote Test Switch</p>	<p>WPST=Factory installed WaveLinx (includes control module, sensor, cable, tilemount and ceiling mount sensor)^{(11) (13)} WLST=Factory installed WaveLinx LITE Sensor Kit^{(11) (12)} WPN = WaveLinx PRO Wireless Node without sensor⁽³¹⁾</p>
<p>EMBOD7ST=Bodine® Self Test Emergency Module⁽¹⁰⁾ EMV7=7W Low Voltage Emergency Module with Remote Test Switch⁽⁷⁾ EMV14=14W Low Voltage Emergency Module with Remote Test Switch⁽⁷⁾ ETRD=Emergency transfer device⁽²⁹⁾</p>	

Accessories (Order separately) ⁽²⁴⁾		
<p>TRM6P=White Metal Trim Ring⁽²⁵⁾ LGSKT6IP66=IP66 Gasket Kit DT6RF=Deco Trim Ring Frosted⁽²⁶⁾</p>	<p>Connected Lighting Systems^{(6) (11)} WPST = Field installed WaveLinx sensor Kit⁽¹³⁾ WLST = Field installed WaveLinx LITE Sensor Kit⁽¹²⁾</p>	<p>Transformers H347=H347 for 90/97CRI 5500 lumens and below; 98CRI 4000 lumens and below; D2W 4500 lumens and below; W2N 4000 lumens and below H347200=347 to 120V Step Down Transformer, 200VA</p>

- Notes:**
- Only product configurations with these designated prefixes are built to be compliant with the Buy American Act of 1933 (BAA) or Trade Agreements Act of 1979 (TAA), respectively. Please refer to [DOMESTIC PREFERENCES](#) website for more information. Components shipped separately may be separately analysed under domestic preference requirements. Offered with spun aluminum narrow (N), medium (M) and wide (W) trims.
 - Nominal Lumens will vary depending on selected color, CRI, driver and reflector finish. Reference [Multiplier tables](#).
 - Product is marked spacing. [Reference table on page 4 for the spacing details](#).
 - DMX fixtures default to full on upon loss of DMX signal.
 - Not available with Chicago Plenum.
 - ULus listed only
 - Offered up to 7000 lumens for 90 and 97 CRI
 - D010TR, DMX up to 4500 lumens for 90 and 97 CRI
 - DLE, DL2 up to 3500 lumens for 90 and 97 CRI
 - Not available for W2N or 6500-7000 lumens.
 - Refer to system specifications for additional information, features, and benefits. Order either factory installed option or accessory. Use with 0-10V driver.
 - WLST = WaveLinx LITE tilemount sensor kit for daylight dimming, PIR motion sensing, use with D010 only (Refer to WaveLinx LITE system specifications)
 - WPST = WaveLinx wireless sensor kit for daylight dimming, PIR motion sensing, and optional RLTS - Real Time Location Services, use with 0-10V only.
 - Black or white paint.
 - Spun aluminum only
 - PS available in self-flanged MW finish only
 - Offered up to 2000 lumens
 - Flange is the same finish as the reflector
 - Anodized or spun reflectors
 - Die cast only
 - 8-9/16" requires ABR8 adapter ring
 - Offered with DLVP up to 3000 lumens for 90 and 97 CRI
 - Accessories sold separately will be separately analyzed under domestic preference.
 - Order trim with polymer trim ring.
 - Order with self flanged trim.
 - If using remote driver order battery and controls with the remote driver.
 - 120V-277V
 - Used to bypass local control during outage. Must be used in conjunction with UL 1008 device (provided by others).
 - Non-IC
 - WPN = WaveLinx PRO wireless node provides luminaire-level control with scene and zone configuration without an integrated sensor; Connects wirelessly with daylight dimming sensor and PIR motion sensor if desired. Use with 0-10V driver only.

Connected Solutions

WaveLinX LITE - WLST Tilemount Sensor



- Intuitive Android™ or Apple® iOS® app for basic system code compliant set up and configuration via Bluetooth
- Up to 28 unique areas per project site (WaveLinX LITE Bluetooth network)
- Up to 50 devices for an area, any one of 16 control zones, up to 6 occupancy sets, and custom lighting scenes
- Automatic occupancy or vacancy, sensor sensitivity, daylight dimming, etc. configurable through the app
- Refer to the WaveLinX system specifications for details



WaveLinX LITE WLST Tilemount Wiring Diagram

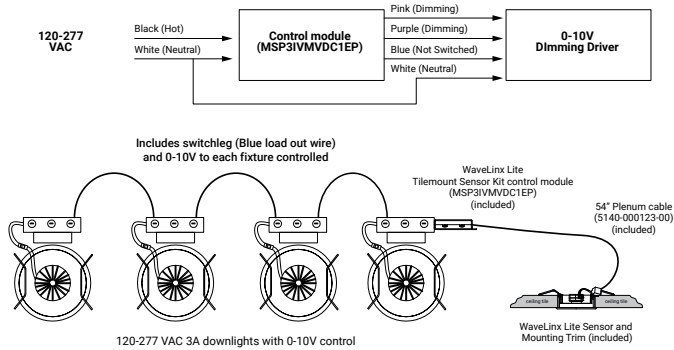

WaveLinX LITE Bluetooth Enabled System



WaveLinX PRO Wireless – WPST Tilemount Sensor



- WaveLinX PRO Wireless functionality configures zones and customizes settings from one secure mobile app
- Automatic code commissioning that meets the strictest codes
- Fixtures and sensors integrate with Wireless Area Controller, Wall Stations, and Control Devices
- Stand-Along Offices or Entire Building Network Installations

WaveLinX mobile app settings

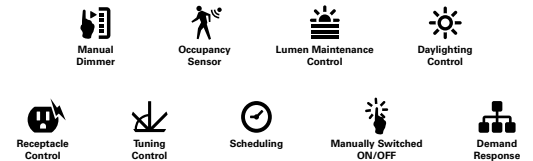

Downlights with tilemount sensor wireless communication
Highly efficient LED fixtures

WaveLinX Area Controller
Provides centralized coordination of multiple area control options

Wireless Wall Station/Receptacle
Provides customized wireless control of each area

Mobile Applications
Provides personalized, local control from a tablet or smartphone

WaveLinX PRO WPST Tilemount Wiring Diagram

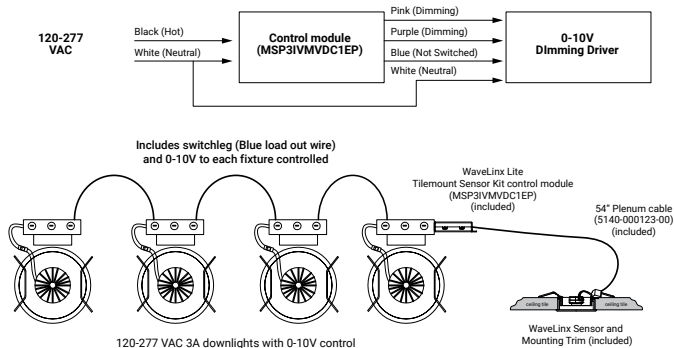

WaveLinX CORE Building Management Integration

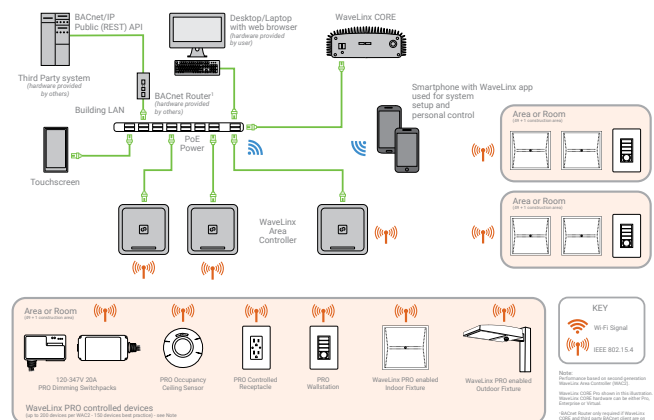

Connected Solutions

WaveLinx PRO Wireless Node - WPN

- WaveLinx Wireless functionality configures zones and customizes settings from one secure mobile app
- Automatic code commissioning that meets the strictest codes
- Fixtures and sensors integrate with WaveLinx Area Controller, Wall Stations, and Control Devices
- Stand-Alone Offices or Entire Building Network Installations



WaveLinx mobile app settings

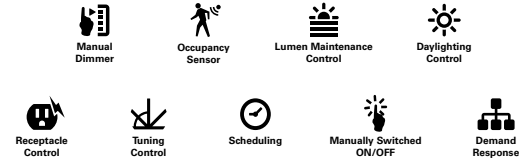

WaveLinx PRO Wireless Node (WPN) Wiring Diagram

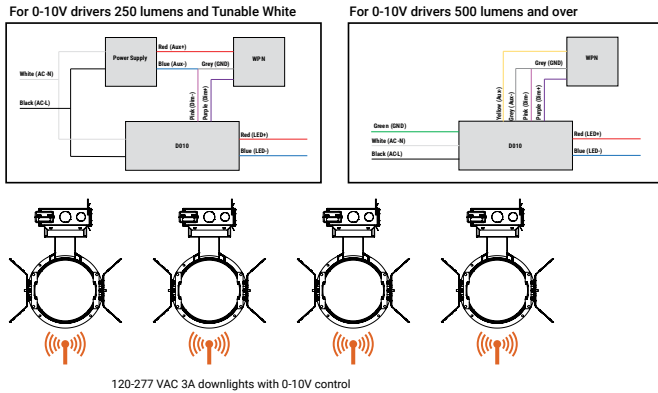

WaveLinx CORE Building Management Integration

