

Project		Catalog #		Type	
Prepared by		Notes		Date	

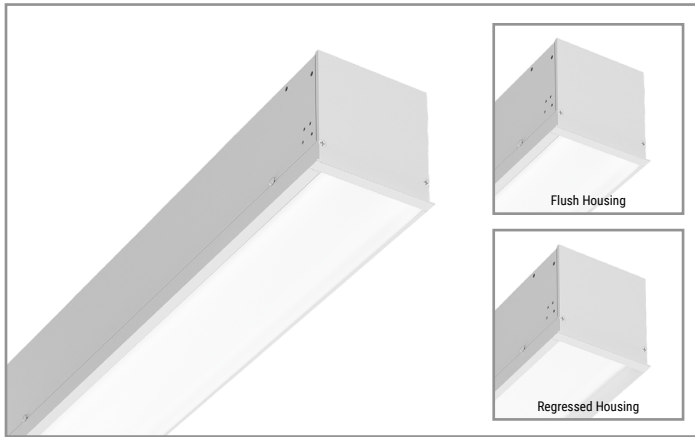

Neo-Ray

Define 5

LED
Recessed Perimeter
Direct

Typical Applications

Office • Education • Healthcare • Hospitality • Retail

Interactive Menu

- Order Information [page 2](#)
- Shielding Options [page 3](#)
- Photometric Data [page 4](#)
- Integrated Sensor Details [page 6](#)
- VividTune [page 7](#)

Product Certification



Product Features



Top Product Features

- Specifiable to the nearest 1" in length
- Satin Lens, Asymmetric Lens and Drop Lens available
- Flush and Regressed Housing
- Customizable lumen packages
- Precision extended trims fit a variety of different architectural ceiling types
- Industry leading performance and efficacy
- [Standard and custom corners / transitions available](#)
- Options to meet Buy American Act requirements

Dimensions

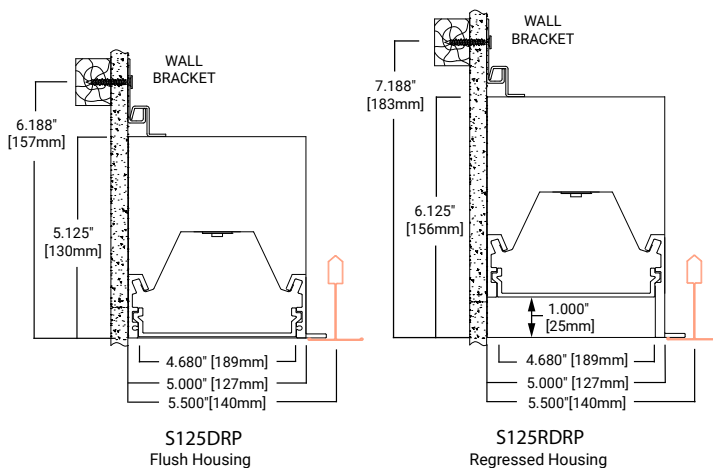

additional product diagrams

Order Information

SAMPLE ORDER NUMBER: **S125DRP-C850D840-ETG4F0-1B1-UDD-F-W-SWPD1**

Icon Key: Grey bar denotes available with Define Core
 ∅ Consult factory for availability

Domestic Preference	Light Distribution	Light Engine	Lumen Package Down	CRI	LED CCT	Ceiling Type	Length	Circuiting
[Blank] =Standard BAA =Buy American Act	S125DRP =Define 5 Direct Recessed Perimeter S125RDRP =Define 5 Regressed Direct Recessed Perimeter	-S =Standard -H =High Performance -V =VividTune	375D =375 Lms/ft 610D =610 Lms/ft 850D =850 Lms/ft 1090D =1090 Lms/ft 1270D =1270 Lms/ft ___ D =Custom Lms/ft	8 =80 9 =90	27 =2700K 30 =3000K 35 =3500K 40 =4000K 50 =5000K 2765 =2700K-6500K 3050 =3000K-5000K	-ETG =15/16" T-Grid -FTG =9/16" T-Grid -STG =9/16" Slot T-Grid -FTT =9/16" Tegular T-Grid -ITG =9/16" Interlude T-Grid -ETT =15/16" Tegular T-Grid -GYP =Gypsum board -FSR =Mud-in Gypsum Board -FES =Finished Extruded Side	2F0 =2' Individual 4F0 =4' Individual 8F0 =8' Individual 12F0 =12' Individual ___ F0 =4' Incremental Run (e.g. 40F0 = 40' 0") ___ F =1" Incremental Run (e.g. 21F3 = 21' 3")	-1 =Single Circuit -S =Secondary Circuit
Notes Only product configurations with this designated prefix are built to be compliant with the Buy American Act of 1933 (BAA). Please refer to DOMESTIC PREFERENCES website for more information. Components shipped separately may be separately analyzed under domestic preference requirements.	Notes RDR regress of 1" will add an additional 1" to fixture depth.	Notes See performance table for add'l details. Light engine must be consistent across run length.	Notes 3500K/80CRI/DR housing/F Lens. Please refer to scaling data for other variables. For custom lumen output, please refer to additional information on page 4. VividTune available with 850D, 1090D, and 1270D.	Notes Additional lead-time and cost may apply for 927, 930, 935 and 940 configurations. 2765/3050 VividTune configurations require V light engine and W2A driver.	Notes Please refer to ceiling interface diagrams for additional detail and dimensions.	Notes	Notes Secondary circuit similar to A/B switching. Price adder applies for "S" configuration.	

Emergency	Voltage	Integral LED Driver	Shielding Down	Options	Color	Integrated Sensor
E =Emergency circuit B1 =Surelite 7W UNV integral battery B2 =Surelite 14W UNV integral battery B3 =Bodine 6W UNV Integral T =UL924 EPC Emergency Bypass Relay	-U =UNV 120-277V -1 =120V -2 =277V -3 =347V -4 =48VDC ∅	DD =0-10 Volt Dimming, 1% 5L =DALI Dimming, 5%-100% L5 =Lutron LDE5 w/ecosys LH =Lutron LDE1 w/ecosys LV1 =DLVP ∅ W2A =White Tuning, 0-10V Dimming (VividTune only)	-F =Satin Flush Diffuser -A =Asymmetric Wall -C =Asymmetric Corridor -D =Satin Drop Diffuser	-CP =Chicago Plenum -R =GLR Fuse (Fast) -F =GMF Fuse (Slow)	-W =Matte White -S =Silver -B =Black -C =Custom Color ∅	-SWPD1 =WaveLinX Integral -SWTPD1 =WaveLinX Tilemount -LWIPD1 =LumaWatt Pro Integral -LWTPD1 =LumaWatt Pro Tilemount -SVPD1 =Standalone Sensor -SVTPD1 =Standalone Sensor Tilemount
Notes Internal battery standard for fixtures ≥ 4ft and lumen output ≤1270 Lms/ft. Fixture Non-IC-Rated for internal battery and lumen output ≥1090 Lms/ft. External battery standard with chicago plenum.	Notes 48V for use with LV1 driver. 347V only available with DD driver.	Notes DD driver is standard. For non-dimming applications, the driver will default to full brightness if no connection is made to the capped dimming wires in the field.	Notes All lensing options are snap-in lenses. Corridor option utilizes asymmetric lens directed away from the wall.	Notes	Notes	Notes Please refer to page 6 for additional detail required to specify integrated or tile-mount sensors. Integral option not available with regressed, drop or asymmetric configurations. Tilemount configuration recommended for these applications.

Product Specifications

Construction

- Available in Flush and Regressed Housing
- Precision cut housing trim extruded from 6063 aluminum with aluminum frame
- Extruded end-caps ensure a precise and uniform ceiling interface
- Nominal 2' -12' illuminated sections used in run configuration and/or individual fixtures

Finish

- Electrostatically applied polyester powder coat paint

LED Module

- Modular LED tray assembly comprising reflector, light engine, led driver and quick disconnect wire-harness for ease of installation and maintenance over the life of the luminaire

Light Engine

- Offered with three next generation Neo-Ray light engines delivering industry leading efficacy and long-life
- LED's are available in 2700K, 3000K, 3500K, 4000K or VividTune ranges of 2700K-6500K and 3000K-5000K
- CRI options of either ≥80CRI or ≥90CRI (Lumen output will be affected - please refer to the lumen adjustment factor table)

LED Drivers

- LED system coupled with electrical driver
- Traditional electronic drivers are available for 120-277V and 347V applications
- Eaton's DLVP Low voltage drivers are available for 48VDC applications

Controls and Integrated Sensors

- Equipped standard with a 0-10V continuous dimming driver. Compatible with most standard dimming devices
- Additional control types are available (DALI, Lutron, DLVP) at an additional cost
- WaveLinx and LumaWatt Pro wireless sensors as well as stand-alone sensors available

Mounting

- Recessed Perimeter

Lengths

- Available in any length (23" min) with a resolution of 1 inch. Max section length of 12ft (8ft max option available)
- Additional fixture lengths are available please consult factory. All lengths are nominal
- VividTune available as standard product in 1ft resolution
- Actual sizes are one inch shorter than nominal to allow easy in-grid installation
- For Gypsum or Flangeless installations add 1 inch to overall fixture length (e.g. 4F1 for 48" length)
- Refer to ceiling type section of specification sheet and submittal drawings for actual sizes

Corners and Transition Pieces

- Corners and other transition pieces are fully luminous
- Constructed using precision mitered frame and lens components
- The frame is welded to ensure a precise and robust assembly
- Standard 90° horizontal and vertical corners as well as custom corners are available
- [Consult corner and pattern addendum for additional information](#)
- Alternative transition pieces such as T's, Y's, X's, etc. are also available Ø

Snap-In Lensing Options

- Satin Flush - Flush, high diffusion glare-free lens
- Satin Drop - 1" Drop, high diffusion glare-free lens
- Asymmetric - Flush, low-glare Asymmetric lens
- Asymmetric Corridor - Asymmetric lens optimized to drive light away from wall and into the corridor
- Flush options ship with our patent-pending underlens solution, the proud lens ships with an injection molded end cap to eliminate light leak

Reflectors

- Precision formed cold-rolled steel reflectors with high reflectivity
- Ultra high reflectivity used with High Performance light engine

Lumen Maintenance

- 90% (L90) of initial light output at 100,000+ hrs
- 70% (L70) of initial light output at 400,000+ hrs
- Derived from TM-21 standard @25°C ambient and typical operating conditions

Custom Lumen Output

- Custom lumen output expressed option in Lumens per foot (e.g. -725D for 725 Lms/ft down). Refer to additional detail on page 4.

Electrical

- Dimming provided as standard
- Dimming wires capped with wire-nuts for non-dimming applications
- Optional battery backup options provided
- Default battery location is internal to fixture
- Default emergency section is 4ft in length and located at the beginning of the fixture unless designated elsewhere
- Estimated lumen output = battery wattage * min efficacy (see performance table)
- The EPC option will bypass local controls and dimming upon loss of normal power. This option is required when the fixture has both integrated sensors and emergency circuiting

Integrated Sensors

- Please reference page 6 for details

Weight

- 2.65 lbs per foot

Approvals

- cULus - listed for damp locations
- RoHS compliant
- Meets NYC requirements
- Meets CCEC requirements
- IC Rated for insulation contact (except where noted)
- Tested to IESNA LM-79 and LM-80
- Can be used for State of California Title 24 high efficacy luminaire
- DesignLights Consortium® Qualified and classified for both DLC Standard and DLC Premium, refer to www.designlights.org for details

Warranty

- Five year warranty standard.

Shielding Options

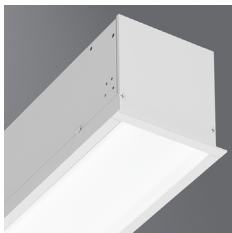

S125DRP with Flush Satin Lens (F)

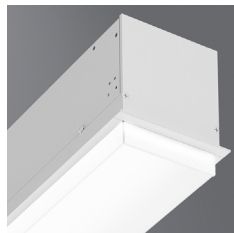

S125DRP with Drop Satin Lens (D)

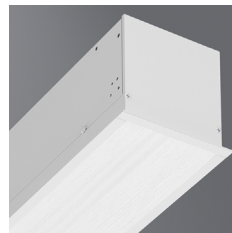

S125DRP with Flush Asymmetric Lens (A)

Photometric Data

View IES files

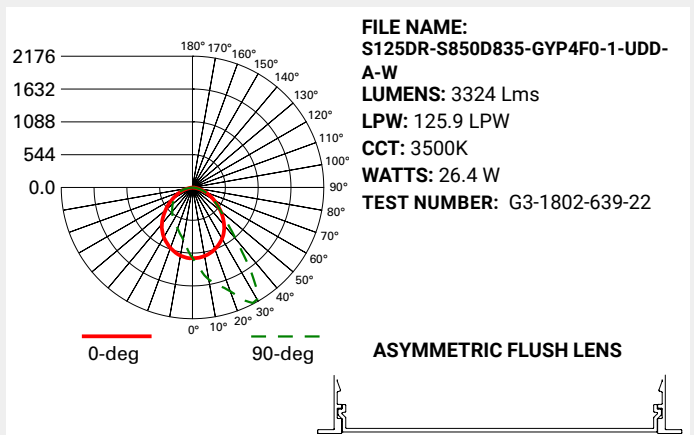
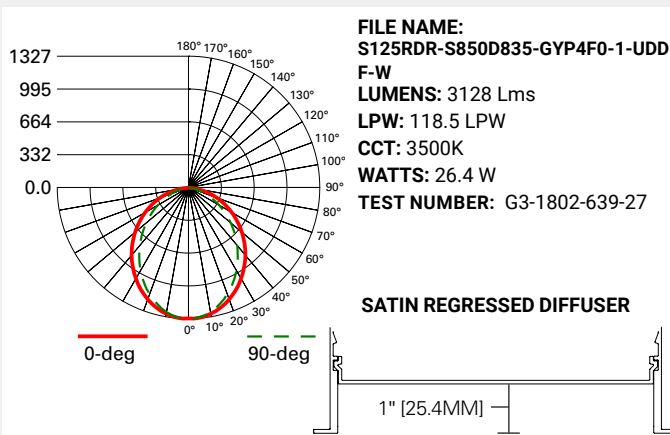
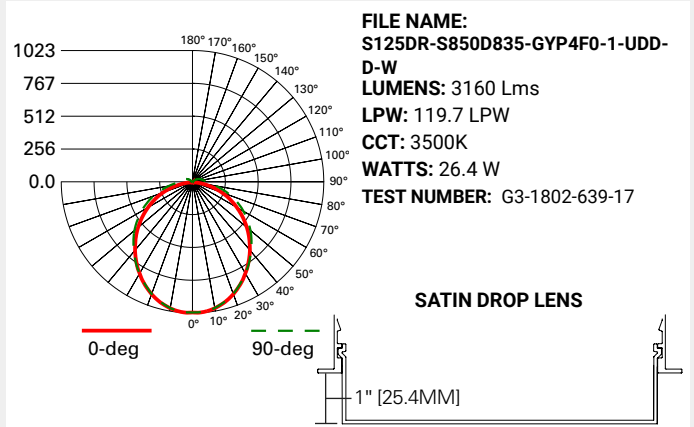
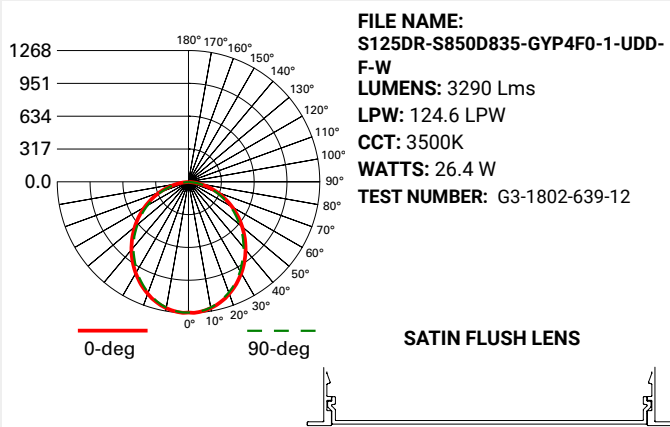

Photometric Overview and Performance Data

Performance Per Linear Foot at 3500K/80CRI

Nominal Output	Standard and VividTune Light Engine		High Performance Light Engine	
	W/ft	lm/W	W/ft	lm/W
375	3.0	124	2.9	131
610	4.8	126	4.4	138
850	6.8	124	6.1	138
1090	8.9	121	8.1	135
1270	10.6	118	9.7	131

Lumen Adjustment Factors

CCT	80CRI	90CRI
2700K	N/A	0.801
3000K	0.943	0.815
3500K	1.000	0.861
4000K	1.010	0.892

LUMEN ADJUSTMENT CALCULATIONS

Example 1 - Adjusted Lumen Output

Nominal Lumen Output selected = 1025 lms/ft (based on standard of 3500K/80CRI)
Lumen Adjustment Factor = 0.801 (2700K/90CRI desired)

Adjusted Lumen Output = Nominal Lumen Output x Lumen Adjustment Factor
Adjusted Lumen Output = 1025 lms/ft x 0.801 = 821 lms/ft

Example 2 - Custom Lumen Output based on Required Lumens Per Foot

Total light output (4ft) requirement of 2800 lms, desired CCT and CRI of 4000K/80CRI

Total required lumens per foot @ 4000K = 2800 lms / 4 ft = 700 lms/ft
Lumen Adjustment Factor = 1.018 (Requirement based on 4000K / 80CRI)

Total required lumens per foot @ 3500K / 80CRI = 700 lms/ft ÷ 1.018 = 688 lms/ft

Estimated efficacy = 121 lm/W (find nearest value using table above)
Estimated power consumption = 688 lms/ft ÷ 121 lm/W = 5.69 W/ft

Custom Lumen Output

Total Light Output Range (lms/ft)

CCT	80CRI	90CRI
2700K	N/A	198-1113
3000K	234-1310	202-1132
3500K	248-1389	213-1196
4000K	250-1403	221-1239

If your requirement is expressed in power consumption (W/ft) rather than light output, you can use the power to lumen output curves to convert power consumption to light output for specification.

Efficacy for custom lumen outputs can be estimated using lumen output curves or with the use of our online custom lumen output tool.

Ceiling Type

Extruded Trim Flange Details - Refer to submittal drawings for detailed flange information - for additional options consult factory.

Grid Ceiling Systems

15/16 Tee (ETG)

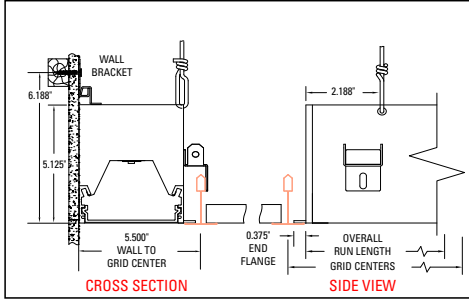

9/16 Tee (FTG)

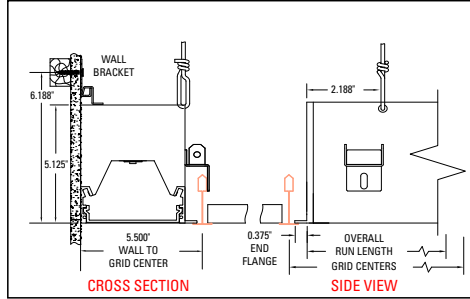

9/16 Slotted Tee (STG)

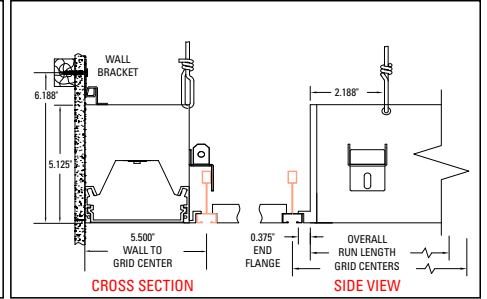

9/16 Tegular (FTT)

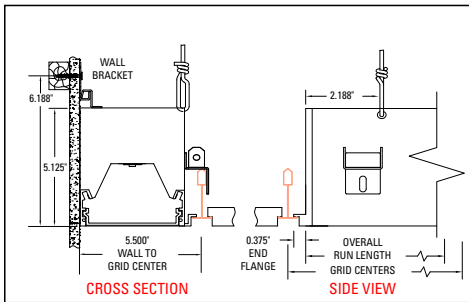

15/16 Tegular (ETT)

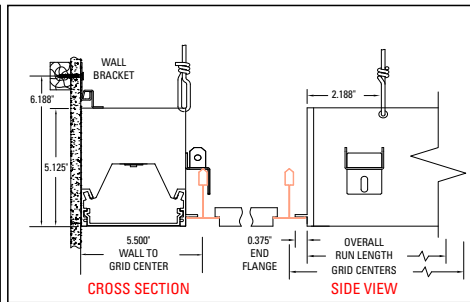

9/16 Interlude Tee (ITG)

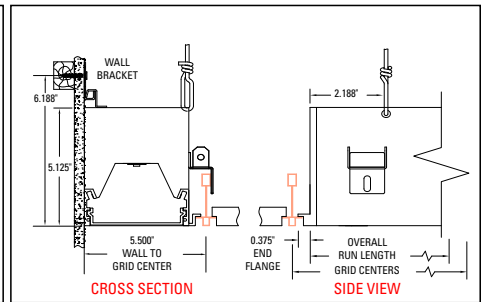

Drywall Ceiling

Visible Flange (GYP)

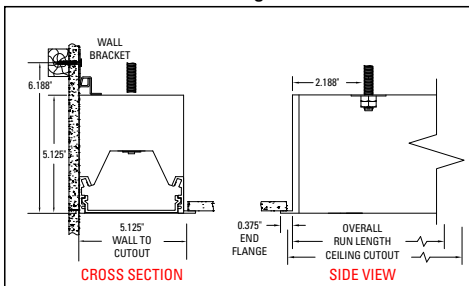

Mud-In Flange (FSR)

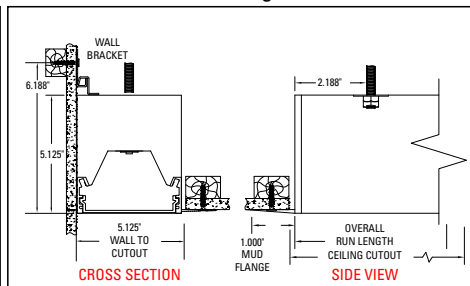

NOTE: ACTUAL LENGTH OF GYP/FSR FIXTURES WILL BE 1" SHORTER IN LENGTH THAN TOTAL REQUESTED RUN LENGTH FOR ALL RECESSED / PERIMETER FIXTURES
 OVERALL RUN LENGTH = 'FIXTURE ORDER LENGTH' - 1"
 E.G. - OVERALL RUN LENGTH OF 3' 11" WILL SHIP WHEN ORDERING A '4FO' FIXTURE
 CEILING CUTOUT = 'OVERALL RUN LENGTH' + 0.250"
 OR CEILING CUTOUT = 'FIXTURE ORDER LENGTH' - 0.750"
 E.G. - CEILING CUTOUT WHEN ORDERING A '4FO' LENGTH FIXTURE WILL BE 3' 11.250"

Other Ceiling Systems (Wood, Fabric, Metal Pan, Techzone style, Box)

Finished Extruded Side (FES)

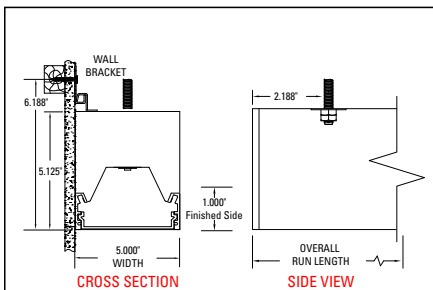

Typical Installations using Finished Extruded Side (FES)

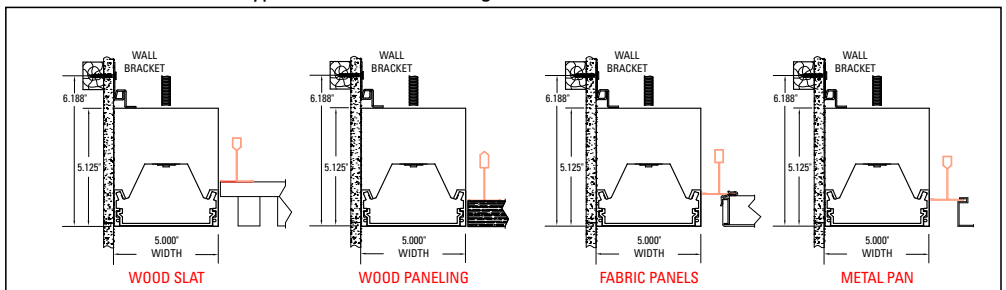

Integrated Sensor Details and Placement

Sensor Type	Wireless	Sensor Integration	Sensor Mounting	Ordering Code
WaveLinX	Yes	Integral to Fixture	Mounted in solid cover	SWPD1
		Pre-wired for tile-mount	Installation in ceiling tile or J-Box cover	SWTPD1
LumaWatt Pro (enlighted)	Yes	Integral to Fixture	Mounted in illuminated lens	LWIPD1
		Pre-wired for tile-mount	Installation in ceiling tile or J-Box cover	LWTPD1
Stand-Alone SVPD1	No	Integral to Fixture	Mounted in solid cover	SVPD1
		Pre-wired for tile-mount	Installation in ceiling tile or J-Box cover	SVTPD1

Optional standalone and wireless connected integrated sensors require use of the DD (0-10V) driver. WaveLinX and LumaWatt Pro sensors require additional system hardware (not provided) for full functionality. Tilemount sensor recommended for optimal sensor coverage on perimeter applications. Tilemount sensor not available with Chicago plenum option.

Standard sensor layout is shown below. Please refer to sensor coverage pattern diagrams to ensure proper coverage for the application. Standard configurations are available in both individual fixtures and in continuous runs. For optimal coverage, continuous runs will default to 8ft max section length.

For additional information integrated sensors and connected lighting, please visit [Eaton's Connected Lighting Website](#).

- Standard Sensor with Luminaire Control
- Auxiliary Sensor used for Sensor Coverage (wireless systems only)

INTEGRAL SENSOR

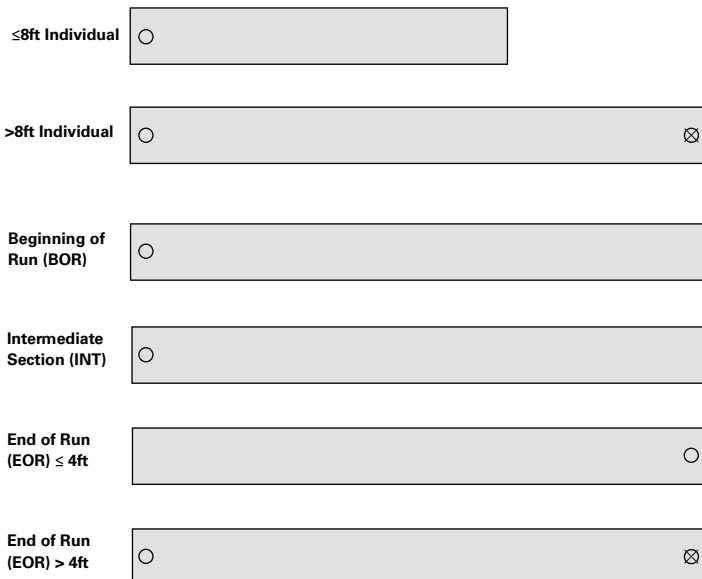

TILEMOUNT SENSOR (OPTIMAL LOCATION)

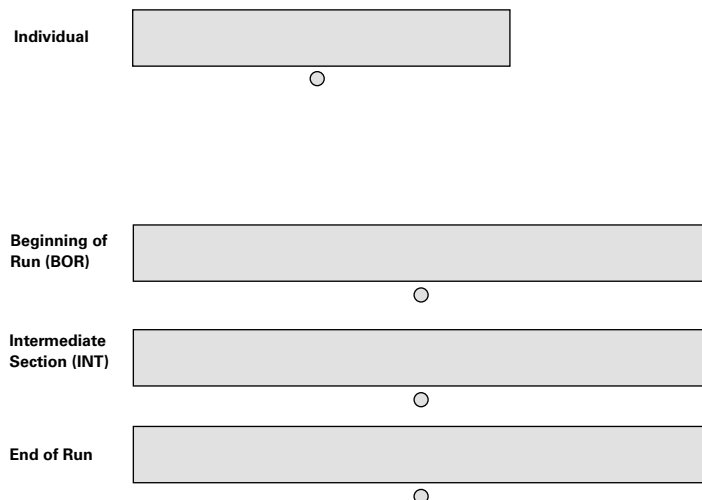



Define 5 LED Recessed Perimeter with VividTune Tunable White

VividTune tunable white luminaires deliver high-quality light in a broad range of continuously variable color temperatures and intensities. Create a dynamic environment by adjusting the ambient light warmer or cooler to influence mood, support the task at hand, or create a dramatic ambience. The ability to control correlated color temperature and intensity separately using simple controls is the next evolution of LED lighting for the commercial, educational, healthcare and hospitality space. The unparalleled flexibility and number of available lighting environments enable users to find the right light with tunable white.

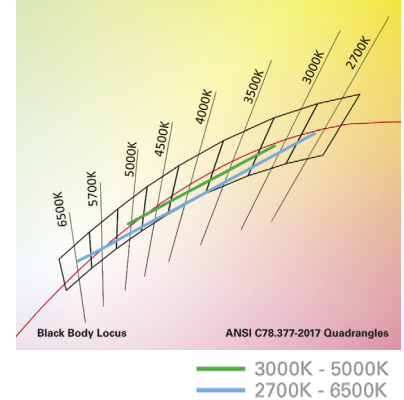

Performance Data*

Tunable White - Lumen Adjustment Factors				
CCT	3000K-5000K		2700K-6500K	
	80 CRI	90 CRI	80 CRI	90 CRI
2700K	-	-	0.868	0.741
3000K	0.894	0.736	0.893	0.771
3500K	0.946	0.804	0.924	0.809
4000K	0.993	0.868	0.944	0.835
4500K	1.002	0.883	0.961	0.857
5000K	1.002	0.883	0.974	0.874
6500K	-	-	0.988	0.897

Example of Approximate Lumen Calculation			
	Standard Catalog #	VividTune 80 CRI Catalog #	VividTune 90 CRI Catalog #
CCT Setting	S125DRP-C1090D835-X-UDD-F-W	S125DRP-V1090D83050-X-UW2A-F-W	S125DRP-V1090D93050-X-UW2A-F-W
3000K	-	3898	3209
3500K	4360	4125	3505
4000K	-	4329	3784
4500K	-	4369	3850
5000K	-	4369	3850

Controlling VividTune Tunable White

VividTune luminaires make tunable white more accessible by using simple and familiar controls. From wall dimmers to wireless controls, VividTune tunable white luminaires are compatible with industry standard 0-10V dimming controls. A single 0-10V dimming input is used to control intensity (brightness) while a second 0-10V dimming input is used to adjust CCT. For suggested control configurations, go to www.eaton.com/lighting for tunable white application guides.

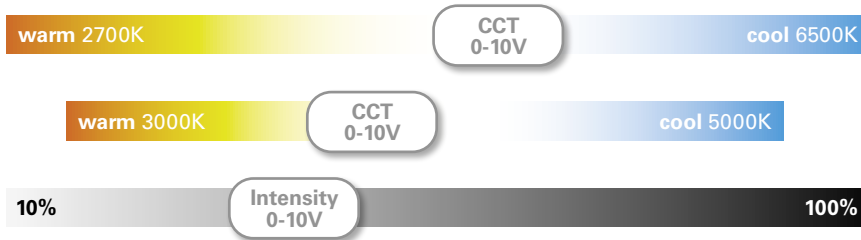

Example of Lumen Adjustment Calculation

S125DRP-V1090D83050-X-UW2A-F-W
at 80 CRI tuned to 3500K

Adjusted Lumen = published lm x adjusted lm factor

Adjusted Lumen = 4360 x 0.946

Adjusted Lumen = 4125 lm

* Lumen adjustment factors are for reference and may be different for each product selected. Refer to IES files for actual performance data on each.