

Project		Catalog #		Type	
Prepared by		Notes		Date	



# Metalux

## VT4 LED

### 4' Industrial Vaportite LED Industrial

#### Typical Applications

Cold Storage • Canopy • Warehouse • Food Processing • Manufacturing • Complex Environments

#### Interactive Menu

- Order Information page 2
- Photometric Data page 3
- Product Warranty

#### Top Product Features

- 4ft Sealed and Gasketed Vaportite
- Lumen packages up to 30K lumens
- High-Performance efficacy up to 146 LPW
- LEDs available in 3500K, 4000K and 5000K at 80 CRI
- Rated for -40c to 40c ambient
- Options to meet Buy American and other domestic preference requirements

#### Product Certification



#### Product Features



#### Dimensional and Mounting Details

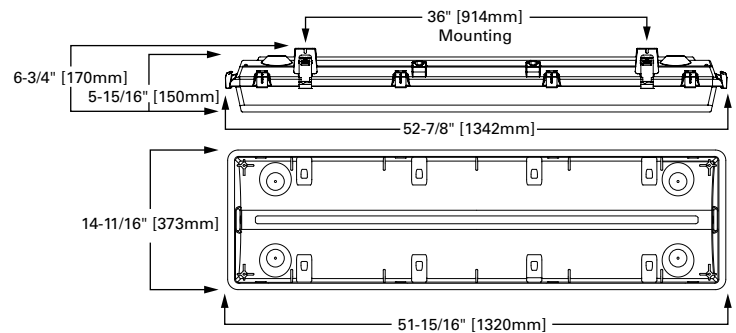
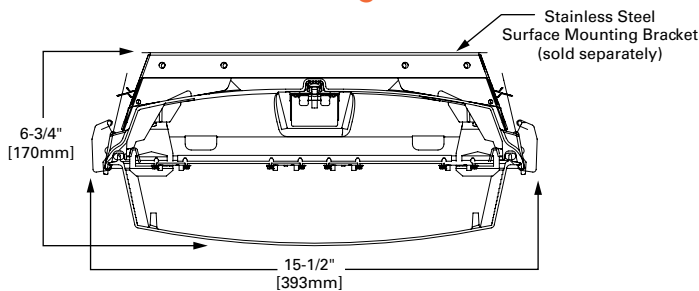

#### Installation Data

##### SS Latches and Mounting Bail

**MOUNTING BAILS**  
Furnished (standard)  
Stainless steel, Two per 4' Unit

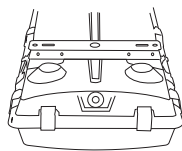
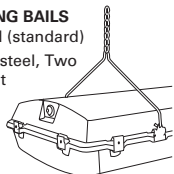

**VT4LED-SS-MKB PK**—Stainless Steel Mounting Bracket (2 per fixture)  
**VT4LED-ZP-MBK PK**—Zinc Mounting Bracket (2 per fixture)

##### ZW-SWPD3 Sidecar

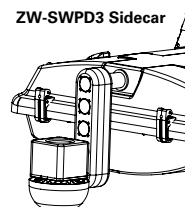

## Order Information

SAMPLE ORDER NUMBER: **VT4LED-LD5-24-DR-UNV-L850-CD2-WL-U**

Domestic Preferences	Series	Lamp Type	LED Lumens Output	Lens	Voltage	CCT	Options Emergency
Domestic Preferences <sup>(1)</sup>	Series <sup>(2)</sup>	Lamp Type	LED Lumen Output <sup>(3)</sup>	Lens	Voltage <sup>(4), (5)</sup>	CCT	Options Emergency
[Blank]=Standard BAA=Buy American Act TAA=Trade Agreements Act	VT4LED=LED Vaportite	LD5=LED 5.0	9=9,000 Lumens 12=12,000 Lumens 15=15,000 Lumens 18=18,000 Lumens 24=24,000 Lumens 30=30,000 Lumens	DR=Clear Acrylic High Impact DRF=Frosted Acrylic High Impact PC=Clear Poly Carbonate	120V=120 Volt 277V=277 Volt 347V=347 Volt 480V=480 Volt UNV=Universal 120-277 Volt UNC=Universal 347-480 Volt	L835=3500K L840=4000K L850=5000K	EL10W=10-watt, 120-277V emergency battery pack installed (available in 9,000 and 12,000 lumen fixtures only) <sup>(7)</sup> VT-REM-EL=Emergency Installed, 700 lumens <sup>(8)</sup>
<b>Notes</b> (1) Only product configurations with these designated prefixes are built to be compliant with the Buy American Act of 1933 (BAA) or Trade Agreements Act of 1979 (TAA), respectively. Please refer to <a href="#">DOMESTIC PREFERENCES</a> website for more information. Components shipped separately may be separately analyzed under domestic preference requirements.	<b>Notes</b> (2) DesignLights Consortium® Qualified and classified for both DLC Standard and DLC Premium, refer to <a href="#">www.designlights.org</a> for details.		<b>Notes</b> (3) Lumen output will vary depending on dimming or fixed output refer to IES files for delivered lumens.		<b>Notes</b> (4) Voltage must be specified when ordered with plugs. (5) When ordering MS option, specify as UNV (for 120 or 277V), 347 or 480V.		<b>Notes</b> (6) Specify 120 to 277V only. (7) EL10W option rated for 0C to 35C ambient.

Driver Type	Number of Drivers	Label	Options	Packaging	Accessories
Driver Type <sup>(8)</sup>	Number of Drivers	Label	Options	Packaging	Accessories (order separately) <sup>(14), (15)</sup>
CD=0-10V Dimming Driver	1=1 Driver (9,000 and 12,000) 2=2 Drivers (15,000, 18,000 and 24,000 lumens) 3=3 Drivers (30,000 lumen)	WL=Wet Label	[Blank]=Plastic Latches and (2) End Watertite Hubs (all Watertite Hubs have 1/2" Conduit Entry) C3=3' Power Cord C6=6' Power Cord PC3=3' Power Cord & Plug (Specify Voltage) PC6=6' Power Cord & Plug (Specify Voltage) VRS=Vandal Resistant Screws for Latches MS=Damp listed Motion Sensor <sup>(9)</sup> MSWL20=Wet location motion sensor, up to 20ft mounting height <sup>(10), (11)</sup> MSWL40=Wet location motion sensor, up to 40ft mounting height <sup>(10), (11)</sup> SSL=Stainless Steel Latches ZW-SWPD3=WaveLinX Wireless Sensor, Sidecar mount, with 1200 sq ft. coverage <sup>(13)</sup> WLS4=WaveLinX Lite Wireless Integrated Sensor, 15'-40' Mounting Height <sup>(12), (13)</sup>	U=Unit Pack	VT4LED-SS-MBK PK=Stainless Steel Surface Mounting Bracket (2 per fixture) VT4LED-ZP-MBK PK=Zinc Mounting Bracket (2 per fixture)
<b>Notes</b> (8) Lumen output will vary depending on dimming or fixed output refer to IES files for delivered lumens.			<b>Notes</b> (9) When ordering MS option, specify as UNV (for 120 or 277V), 347 or 480V. (10) When ordering MSWL option, specify voltage (120, 277, or 347V). 480V not available. (11) MSWL sensor rated up to IP65. (12) WaveLinX Lite devices are not currently compatible with the WaveLinX Pro Wireless Area Controller. (13) Not compatible with EL options. Not available with 347V, 480V, or UNC. Not available with SLTD option.		<b>Notes</b> (14) Mounting beam only available for UNV versions at max. ambient temperature 35°C. (15) Accessories sold separately will be separately analyzed under domestic preference requirements. Consult factory for further information.

## Product Specifications

### Construction

- Rugged and durable construction
- Reinforced fiberglass housing with high impact diffuser
- Incorporates a full hinged metal gear tray secured by internal latches for toolless driver access.
- Polyurethane gasketing provides a continuous seamless seal for the diffuser lens
- Four sturdy cam latches clamp diffuser tightly for a positive seal between housing, gasketing and diffuser
- Stainless steel latches option

### Electrical

- Long-Life LED system coupled with electrical driver for optimal performance
- LED's available in 3500K, 4000K and 5000K with a CRI ≥ 80

- Electronic drivers are available for 120-277V, 347V and 480V applications
- 0-10V dimming control is available
- Operating temperature of -40°C to 40°C

### Lens

- High-impact clear or frosted acrylic or 100% polycarbonate lens options

### Mounting

- Surface, chain, cable or stem mounting
- Suspended mount using two stainless steel mounting bails (included)
- Optional Y-hook, Y-toggle or surface/stem mount bracket available and must be ordered separately

### Warranty

- Five-year limited warranty

### Compliance

- UL/cUL listed for Wet location
- RoHS compliant
- LED modules comply with IESNA LM-79 and LM-80 standards
- NEMA 4X, IP65 and IP67 rated, up to 1500 PSI hosedown
- NSF certified
- DesignLights Consortium® Qualified and classified for both DLC Standard and DLC Premium (refer to [www.designlights.org](#) for details)

**WaveLinX Lite devices are not currently compatible with the WaveLinX Pro Wireless Area Controller**

## Photometric Data

[View IES files](#)

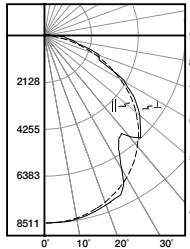

**4T4LED-LD5-24-DR-UNV-L850-CD2-WL-U**  
 Electronic Driver  
 Linear LED 5000K  
 Spacing criterion: (H) 1.28 x mounting height,  
 (L) 1.17 x mounting height  
 Lumens: 24975  
 Input Watts: 179.3W  
 Efficacy: 139.3 lm/W  
 Test Report:  
 VT4LED-LD5-24-DR-UNV-L850-CD2-WL-U.IES

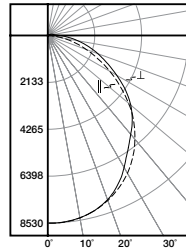

**VT4LED-LD5-24-DRF-UNV-L850-CD2-WL-U**  
 Electronic Driver  
 Linear LED 5000K  
 Spacing criterion: (H) 1.25 x mounting height,  
 (L) 1.2 x mounting height  
 Lumens: 24393  
 Input Watts: 179.2W  
 Efficacy: 136.1 lm/W  
 Test Report:  
 VT4LED-LD5-24-DRF-UNV-L850-CD2-WL-U.IES

## Energy and Performance Data by Catalog Number

Catalog Number	Description	Delivered Lumens			Watts	Efficacy		
		Lensing				Lensing		
		DR	DRF	PC		DR	DRF	PC
VT4LED-9-XX-UNV-L835-CD1	4ft, Vaportight, 9000 lumens UNV, 3500K	8822	8599	8605	64	138	134	134
VT4LED-9-XX-UNV-L840-CD1	4ft, Vaportight, 9000 lumens UNV, 4000K	9002	8774	8781	64	141	137	137
VT4LED-9-XX-UNV-L850-CD1	4ft, Vaportight, 9000 lumens UNV, 5000K	9362	9125	9132	64	146	143	143
VT4LED-12-XX-UNV-L835-CD1	4ft, Vaportight, 12000 lumens UNV, 3500K	11662	11367	11376	93	125	122	122
VT4LED-12-XX-UNV-L840-CD1	4ft, Vaportight, 12000 lumens UNV, 4000K	11900	11599	11608	93	128	125	125
VT4LED-12-XX-UNV-L850-CD1	4ft, Vaportight, 12000 lumens UNV, 5000K	12376	12063	12072	93	133	130	130
VT4LED-15-XX-UNV-L835-CD2	4ft, Vaportight, 15000 lumens UNV, 3500K	14924	14537	14602	112	133	130	130
VT4LED-15-XX-UNV-L840-CD2	4ft, Vaportight, 15000 lumens UNV, 4000K	15229	14834	14900	112	136	132	133
VT4LED-15-XX-UNV-L850-CD2	4ft, Vaportight, 15000 lumens UNV, 5000K	15838	15427	15496	112	141	138	138
VT4LED-18-XX-UNV-L835-CD2	4ft, Vaportight, 18000 lumens UNV, 3500K	17991	17555	17625	133	135	132	133
VT4LED-18-XX-UNV-L840-CD2	4ft, Vaportight, 18000 lumens UNV, 4000K	18358	17913	17985	133	138	135	135
VT4LED-18-XX-UNV-L850-CD2	4ft, Vaportight, 18000 lumens UNV, 5000K	19092	18630	18704	133	144	140	141
VT4LED-24-XX-UNV-L835-CD2	4ft, Vaportight, 24000 lumens UNV, 3500K	23534	22986	22867	179	131	128	128
VT4LED-24-XX-UNV-L840-CD2	4ft, Vaportight, 24000 lumens UNV, 4000K	24014	23455	23334	179	134	131	130
VT4LED-24-XX-UNV-L850-CD2	4ft, Vaportight, 24000 lumens UNV, 5000K	24975	24393	24267	179	140	136	136
VT4LED-30-XX-UNV-L835-CD3	4ft, Vaportight, 30000 lumens UNV, 3500K	29937	29139	29350	232	129	126	127
VT4LED-30-XX-UNV-L840-CD3	4ft, Vaportight, 30000 lumens UNV, 4000K	30548	29734	29949	232	132	128	129
VT4LED-30-XX-UNV-L850-CD3	4ft, Vaportight, 30000 lumens UNV, 5000K	31770	30923	31147	232	137	133	134

### Lumen Maintenance

Ambient Temperature	TM-21 Lumen Maintenance (60,000 hours)	Theoretical L70 (Hours)
25°C	> 92%	> 281,000

### Energy Data

Input Watts:
VT4LED-LD5-9-DR=64W
VT4LED-LD5-12-DR=92W
VT4LED-LD5-15-DR=113W
VT4LED-LD5-18-DR=133W
VT4LED-LD5-24-DR=179W
VT4LED-LD5-30-DR=232W

### Shipping Data

Catalog No.	Wt.
VT4LED-LD5-9-DR	24 lbs.
VT4LED-LD5-12-DR	24 lbs.
VT4LED-LD5-15-DR	24 lbs.
VT4LED-LD5-18-DR	24 lbs.
VT4LED-LD5-24-DR	26 lbs.
VT4LED-LD5-30-DR	26 lbs.