



F-BAY^{ULTRA}47

Industrial Fluorescent

Ultra 47 F-Bay



Maximize Energy Savings Without Sacrificing Performance With The Ultra 47 Fluorescent High-Bay

Cooper Lighting researches, develops and utilizes the latest lamp and ballast technology on the market.

With the launch of the GE T5HO 47W UltraStart® Watt Miser® System, Cooper Lighting is now offering the Ultra 47 HBI, HBL, HBE, I5 and VT4 series of products with the most energy efficient T5 high-output fluorescent system. The design of these products utilizing the GE T5HO 47W UltraStart® Watt Miser® System allows Cooper Lighting to achieve increased fixture efficiency resulting in a similar amount of light as a 54-watt T5HO system while delivering increased energy savings.



System Benefits

- Increased Energy Savings
- Equivalent Light Output
- Lower Maintenance Costs
- Lower Watts / Sq. ft.
- 5 – Year 55C Warranty on Lamps and Ballasts*



SYSTEM WATTS**

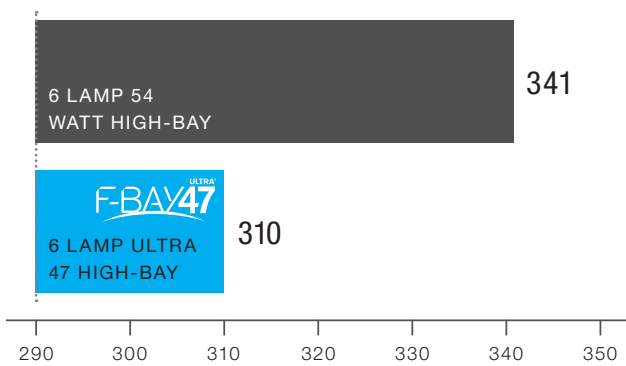

LUMENS PER WATT**

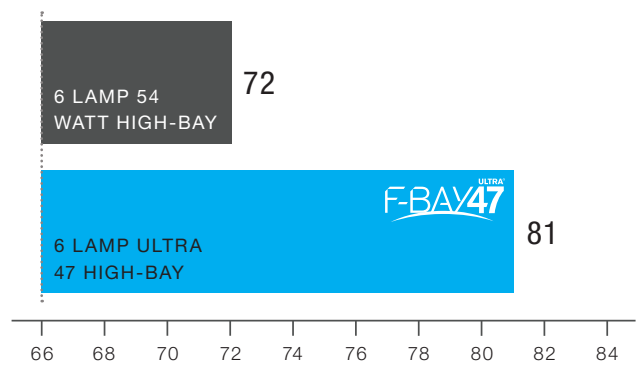

SYSTEM LUMENS**

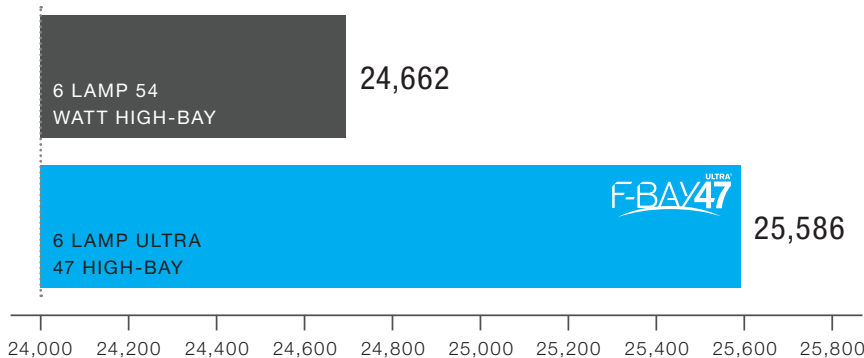

*GE warranty applies to 4 and 6 lamp open upright configurations in the HBI, HBL and HBE series.

**Data based upon in-fixture testing of catalog number HBI647-UPL utilizing IESNA LM-63-02 photometric testing standard.

Industrial Fluorescent

Energy Solutions



SYSTEM BENEFITS
 Energy Savings
 Increased Light Output
 Lower Watts / Sq. ft.

Based on:
 Room Size: 250' x 182'
 Ceiling Height: 30'
 Workplace: 2.5'
 Rack Height: 15'
 Rack Width: 16'

	6 LAMP 54 WATT T5 HIGH-BAY	6 LAMP ULTRA 47 HIGH-BAY
FIXTURE	HBI654-UPL	HBI647-UPL
QUANTITY	77	77
INPUT WATTS	341	310
TOTAL WATTS	26257	23870
ENERGY SAVINGS		9%
ENERGY SAVED kW		2.387
\$/kW * Hr		\$ 0.12
HOURS ON PER DAY		12
ENERGY SAVINGS / YEAR		\$1,254.61

6 LAMP 54 WATT T5

Aisle Vertical fc	12.8
Aisle Horizontal fc	27.45
Warehouse Open Area fc	28.89
Watts / Sq. ft.	0.57
Total Watts	26257
No. of Fixtures	77

6 LAMP ULTRA 47

Aisle Vertical fc	13.04
Aisle Horizontal fc	27.58
Warehouse Open Area fc	29
Watts / Sq. ft.	0.52
Total Watts	23870
No. of Fixtures	77



SYSTEM BENEFITS
 Energy Savings
 Equivalent Light Output
 Lower Watts / Sq. ft.

Based on:
 Room Size: 250' x 182'
 Ceiling Height: 30'
 Workplace: 2.5'
 Rack Height: 15'
 Rack Width: 16'

	400 WATT HID	6 LAMP ULTRA 47 HIGH-BAY
FIXTURE	MHSS40	HBI647-UPL
QUANTITY	104	77
INPUT WATTS	452	310
TOTAL WATTS	47008	23870
ENERGY SAVINGS		49%
ENERGY SAVED kW		23.138
\$/kW * Hr		\$ 0.12
HOURS ON PER DAY		12
ENERGY SAVINGS / YEAR		\$12,161.33

400 WATT HID

Aisle Vertical fc	15.74
Aisle Horizontal fc	27.77
Warehouse Open Area fc	29.52
Watts / Sq. ft.	1.03
Total Watts	47008
No. of Fixtures	104

6 LAMP ULTRA 47

Aisle Vertical fc	13.04
Aisle Horizontal fc	27.58
Warehouse Open Area fc	29
Watts / Sq. ft.	0.52
Total Watts	23870
No. of Fixtures	77

GE T5HO 47W UltraStart® Watt-Miser®



T5HO 47W
UltraStart® Watt-Miser® System

3 Advantages You Can't Deny

Energy Savings Advantage

	54W System	Ultra 47W System**
Lamp Lumens	5,000	4,800
System Lumens (4 Lamp)	20,000	19,200
System Watts	234W	202W
Cathode Energy Cut Ballast	NO	YES – 94% efficiency
Lumens per Watt	85 LPW	95 LPW

Life Advantage

	54W System	Ultra 47W System**
Lamp Life (3hrs / 12hrs)	30K / 36K	30K / 36K
Warranty (Lamp / Ballast)	3 yr + 5 yr	5 yr + 5 yr
UL Certified 55C Ambient	NO	YES – 5 yr warranty
Thermal fold-back protection	NO	YES – protects against overheating

Maintenance Advantage

	54W System	Ultra 47W System**
Lamp Operation	Ser-par	Parallel – one fails others remain on
Starting Time	> 1.1 Sec	< 700ms – important with sensors
Striation Control	NO	YES – reduces striations
Independent Lamp End of Life	NO	YES – only one lamp shuts down @EOL
UL Type CC Anti-arcing	YES	YES – arcing protection
RoHS Reduction Hazardous Substance	NO	YES – think of future disposal today

Energy Savings

4 Lamp	5 Lamp	6 Lamp
\$116	\$145	\$174

\$29 SAVINGS PER LAMP vs 54W*

*Energy savings per one 54W T5 lamp, 30,000 hour burn, & \$0.12 kWhr energy cost.

**Data based upon GE lamp and ballast specifications per ANSI test procedures.



imagination at work

Ordering Information & Photometry

HBI T5

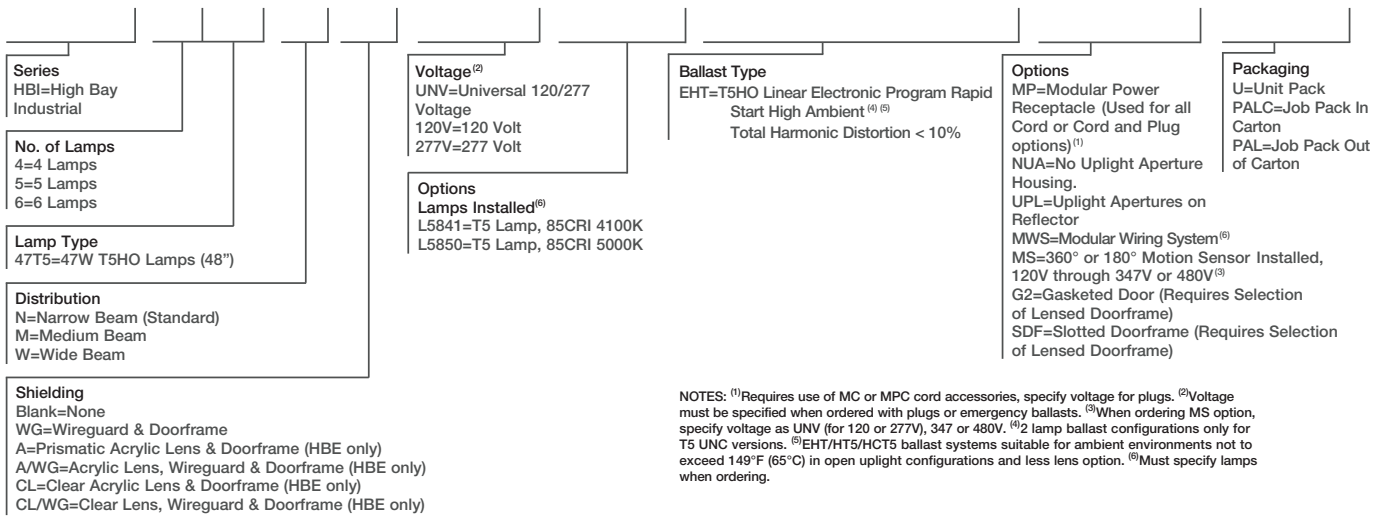

I5

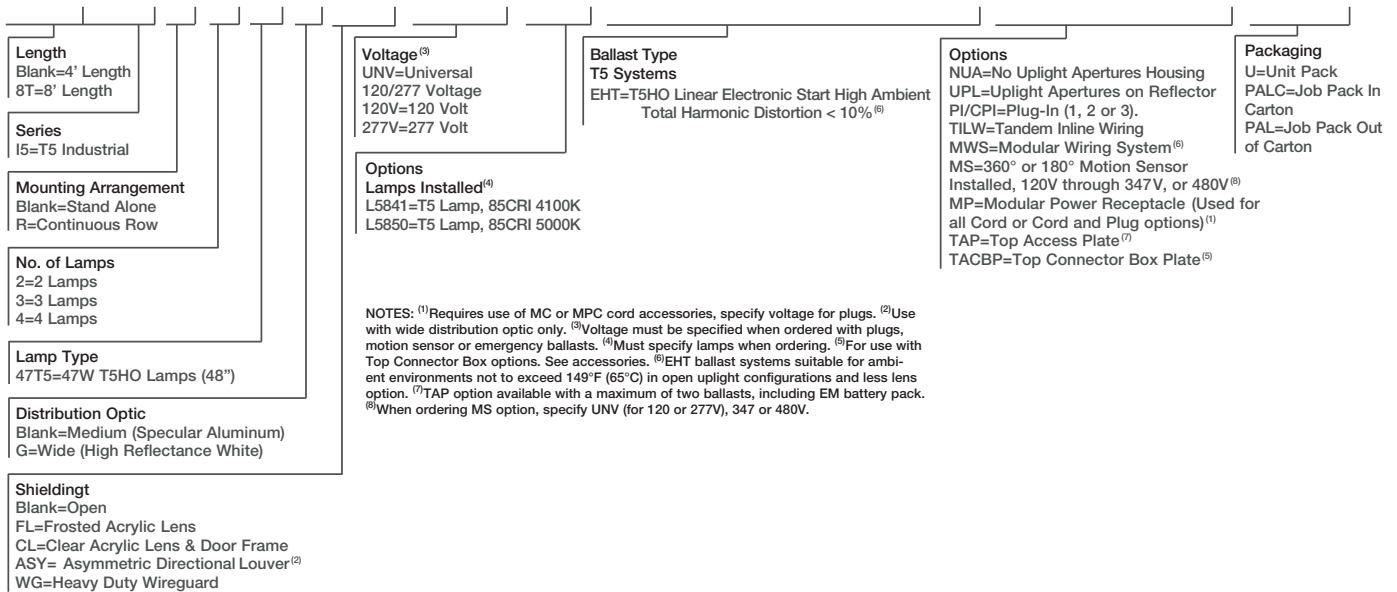

HBE T5 & HBL T5

<p>Series HBE=High Bay Efficiency HBL=High Bay Linear</p>	<p>No. of Lamps 4=4 Lamps 6=6 Lamps 8=8 Lamps 10=10 Lamps</p>	<p>Lamp Type 47T5=47W T5HO Lamps (48")</p>	<p>Distribution N=Narrow Beam (Standard) M=Medium Beam W=Wide Beam</p>	<p>Shielding Blank=None WG=Wireguard A=Prismatic Acrylic Lens & Doorframe (HBE only) A/WG=Acrylic Lens, Wireguard & Doorframe (HBE only) CL=Clear Acrylic Lens & Doorframe (HBE only) CL/WG=Clear Lens, Wireguard & Doorframe (HBE only)</p>	<p>Voltage⁽¹⁾ UNV=Universal 120/277 Voltage 120V=120 Volt 277V=277 Volt</p> <p>Options Lamps Installed⁽⁶⁾ L5841=T5 Lamp, 85CRI 4100K L5850=T5 Lamp, 85CRI 5000K</p>	<p>Ballast Type EHT=T5HO Linear Electronic Program Rapid Start High Ambient⁽⁴⁾ Total Harmonic Distortion < 10%</p>	<p>Options MP=Modular Power Receptacle (Used for all Cord or Cord and Plug options)⁽³⁾ UPL=Uplight Apertures on Reflector MWS=Modular Wiring System⁽⁶⁾ MS=360° or 180° Motion Sensor Installed, 120V through 347V or 480V⁽²⁾</p>	<p>Packaging U=Unit Pack PALC=Job Pack In Carton PAL=Job Pack Out of Carton</p>
--	--	---	---	---	---	---	--	--

NOTES: ⁽¹⁾Voltage must be specified when ordered with plugs or emergency ballasts.
⁽²⁾When ordering MS option, specify as UNV (for 120 or 277V), 347 or 480V. ⁽³⁾Requires use of MC or MPC cord accessories, specify voltage for plugs. ⁽⁴⁾EHT/HT5/HCT5 ballast systems suitable for ambient environments not to exceed 149°F (65°C) in open upright configurations and less lens option. ⁽⁵⁾Must specify lamps when ordering. ⁽⁶⁾Cannot be combined with Modular Power Receptacle (MP). For MWS with MP, choose MP in figure logic and then choose MWS.

PHOTOMETRICS

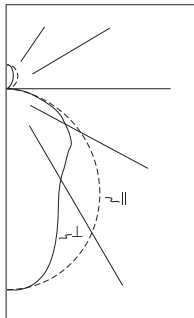

Coefficients of Utilization

rc rw RCR	Effective floor cavity reflectance									
	80%			20%						
	70	50	30	10	50	30	10			
0	117	117	117	117	107	107	107	101	101	101
1	107	102	97	94	93	90	87	88	86	83
2	97	89	82	76	82	77	72	77	73	70
3	89	78	70	64	72	66	61	69	63	59
4	81	70	61	54	64	58	52	61	55	51
5	75	62	54	47	58	51	45	55	49	44
6	69	56	48	41	53	45	40	50	44	39
7	64	51	43	37	48	41	36	46	40	35
8	60	47	39	33	44	37	32	42	36	31
9	56	43	35	30	41	34	29	39	33	29
10	53	40	32	27	38	31	27	36	30	26

HBL-647-N-UPL

Electronic Ballasts
 (6) F54T5-47W Lamps 4285 Lumens

Spacing Criterion: (II) 1.2 x
 mounting height (L) 0.8 x
 mounting height

Efficiency 99.5%

Test Report P30628-R2

Zonal Lumen Summary

Zone	Lumens	%Lamp	%Fixture
0-30	7212	28.0	28.2
0-40	11157	43.4	43.6
0-60	18599	72.3	72.7
0-90	23829	92.7	93.1
90-120	137	0.5	0.5
90-130	307	1.2	1.2
90-150	965	3.8	3.8
90-180	1757	6.8	6.9
0-180	25586	99.5	100.0

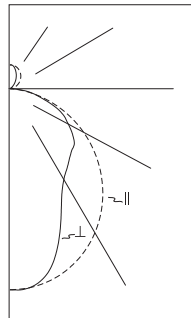

Coefficients of Utilization

rc rw RCR	Effective floor cavity reflectance									
	80%			20%						
	70	50	30	10	50	30	10			
0	99	99	99	99	91	91	91	86	86	86
1	89	84	80	76	77	74	71	73	70	68
2	80	73	66	61	66	61	57	60	59	55
3	73	63	56	50	58	52	47	55	50	46
4	66	56	48	42	51	45	40	48	43	38
5	61	49	41	35	45	39	34	43	37	33
6	56	44	36	31	41	34	29	39	33	29
7	52	40	32	27	37	31	26	35	30	25
8	48	36	29	24	34	27	23	32	27	22
9	45	33	26	21	31	25	21	30	24	20
10	42	31	24	19	29	23	19	27	22	18

HBI-647-N-UPL

Electronic Ballasts
 (6) F54T5-47W Lamps 4285 Lumens

Spacing Criterion: (II) 1.2 x
 mounting height (L) 0.8 x
 mounting height

Efficiency 97.2%

Test Report P30629-R2

Zonal Lumen Summary

Zone	Lumens	%Lamp	%Fixture
0-30	7543	29.3	30.2
0-40	11643	45.3	46.6
0-60	19248	74.9	77.0
0-90	23832	92.7	95.4
90-120	140	0.5	0.6
90-130	259	1.0	1.0
90-150	607	2.4	2.4
90-180	1155	4.5	4.6
0-180	24988	97.2	100.0

Cooper Lighting, LLC.

Customer First Center
1121 Highway 74 South
Peachtree City, GA 30269

P: 770-486-4800
F: 770-486-4801

www.cooperlighting.com

International Sales, USA

Cooper Lighting, LLC.
1121 Highway 74 South
Peachtree City, GA 30269

P: 770-486-4800
F: 770-486-4801

Canada

Cooper Lighting, LLC.
5925 McLaughlin Road
Mississauga, Ontario L5R 1B8

P: 905-507-4000
F: 905-568-7049

The Cooper Lighting Family

Halo
Metalux
Lumark
Sure-Lites
Neo-Ray
Corelite
Portfolio
Iris
Shaper
io
Lumière
Invue
McGraw-Edison
Streetworks
Fail-Safe
PDS
MWS
RSA
Ametrix

Domestic Facilities

Cranbury, New Jersey
Elk Grove Village, Illinois
Irving, Texas
Ontario, California
Peachtree City, Georgia

Canadian Facility

Calgary, Alberta T2E 7V9
Mississauga, Ontario L5R 1B8



25% PCRf

Cooper Lighting and Metalux are valuable trademarks of Cooper Industries in the United States and other countries. You are not permitted to use the Cooper Trademarks without the prior written consent of Cooper Industries.

Cooper Industries plc
600 Travis, Ste. 5600
Houston, TX 77002-1001
P: 713-209-8400
www.cooperindustries.com