

POLE SHAFT SPECIFICATIONS				
1.	SHAFTS ARE ONE SECTION DESIGN FABRICATED FROM A WELDABLE GRADE CARBON STEEL STRUCTURAL TUBING (ASTM A500 GR. B) WITH A UNIFORM WALL THICKNESS. MATERIAL SHALL CONFORM TO ASTM A-500 GRADE B WITH A MINIMUM YIELD STRENGTH OF 46,000 P.S.I.			
2.	BASE PLATES ARE CONSTRUCTED OF A STRUCTURAL QUALITY HOT ROLLED CARBON STEEL PLATE (ASTM A36) WITH A GUARANTEED MINIMUM YIELD STRENGTH OF 36,000 P.S.I.			
3.	ANCHOR BOLTS ARE "L" FORMED BARS HAVING A MINIMUM YIELD STRENGTH OF 55,000 P.S.I., FABRICATED FROM ASTM F1554 GR. 55, THE BOLTS ARE FULLY GALVANIZED PER ASTM A153 SPECIFICATIONS. FURNISHED COMPLETE WITH 2 HEX NUTS AND 2 FLAT WASHERS.			
4.	POLES SHALL HAVE A POLYESTER POWDER COAT FINISH.			
FINISH SPECIFICATIONS				
POLES SHALL HAVE A POLYESTER POWDER COAT FINISH IN A STANDARD COLOR.				
POLE DIMENSIONS				
POLE HGT. (FT.)	TOP DIA. (IN.)	BOTTOM DIA. (IN.)	GAGE	MTG. HGT. (FT.)
12'	3.00	3.00	11 GAGE	12'
BASE PLATE DIMENSIONS				
BOLT CIRCLE (IN.)	BASE PLATE DIM. (IN.)	BOLT HOLE (IN.)	PLATE THK. (IN.)	
8.00-9.00	8.00 SQ	1.00	.75	
ANCHOR BOLT DIMENSIONS				
ANCHOR BOLT DIA. (IN.)		ANCHOR BOLT LENGTH (IN.)		
.75		20.00		
ALLOWABLE WIND LOADING (SQ. FT.)				
WIND* EPA	80 MPH	90 MPH	100 MPH	120 MPH
	6.9	5.0	3.9	2.1

\*WITH 1.3 GUST FACTOR

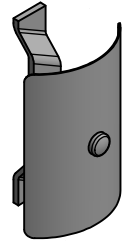

1.63 X 3.50 HAND HOLE COVER

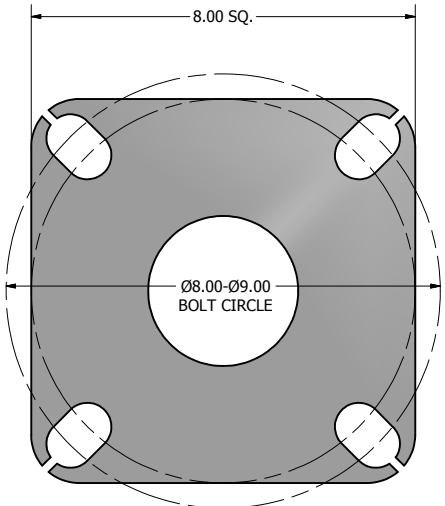

8.00 X 8.00 X .75 THK. BASE PLATE

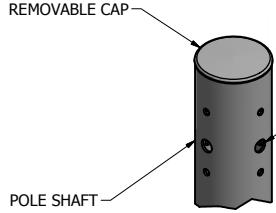

POLE SHAFT

DRILLED MOUNT OPTIONS

- DRILLED PER FIXTURE REQUIREMENTS:
- D1- DRILLED FOR 1 FIXTURE
- D2- DRILLED FOR 2 FIXTURES AT 90° OR 180°
- D3- DRILLED FOR 3 FIXTURES AT 90° OR 120°
- D4- DRILLED FOR 4 FIXTURES

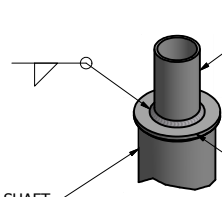

POLE SHAFT

- TENON MOUNT OPTIONS:
- T2- Ø2.38 X 4.00 LG
- T3- Ø3.00 X 5.00 LG
- T4- Ø4.00 X 6.00 LG

.25 THK TENON MOUNT

TENON MOUNT OPTIONS

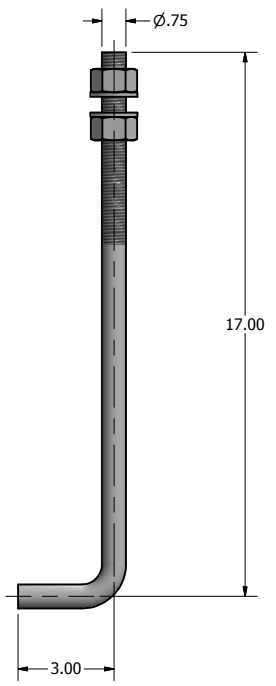

Ø.75 X 20.00 ANCHOR BOLT

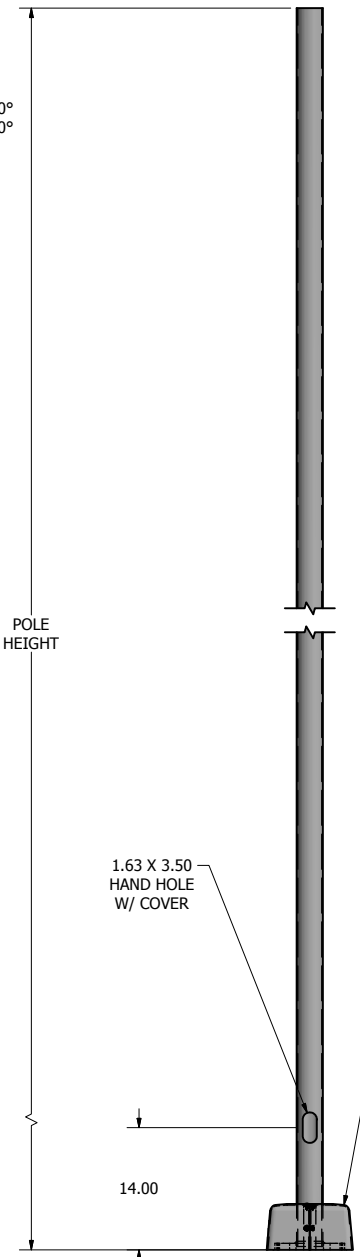

POLE HEIGHT

1.63 X 3.50 HAND HOLE W/ COVER

REMOVABLE ABS BASE COVER

14.00

POLE DETAIL

  
 P.O. Box 340  
 Eastpointe, MI 48021  
 P: (586) 771-4610 | F: (586) 771-5527  
 www.lytepoles.com  
a DWM company

DRAWN: M. HARVALA	2/13/2015
CHECKED:	
REVISION:	DATE:
APPROVED:	
QUOTE:	
S.O.#	
REF:	SCALE: NONE

SOME GEOGRAPHICAL AREAS HAVE SPECIAL WIND CONDITIONS THAT CAN CREATE WIND INDUCED VIBRATIONS CAUSING A FATIGUE PROBLEM. NO METHOD HAS YET BEEN FOUND FOR PREDICTING DESTRUCTIVE LIGHTING POLE VIBRATION. THESE CONDITIONS ARE UNIQUE AND CANNOT BE GUARANTEED AGAINST, AND ARE THE RESPONSIBILITY OF A LOCAL SITE ENGINEER.

TITLE:

CATALOG:

DWG NO: 401-3011-12

SIZE C SHEET 1 OF 1

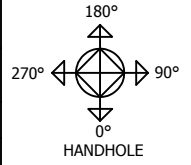

## example order number

Fixture			Catalog Number			Mounting Type	Fixture Mounting Arrangement	Finish	Options			Accessories			
Brand	Product	Number	Design	Shaft Size	Wall Thickness				Mounting Height	Design	Orientation	Height From Base	Design	Orientation	Height From Base
			101	40	11	20	AB	T2	DB	WB-15	@90	10'	FH	@180	9'

## build your order number

Fixture			Catalog Number			Mounting Type	Fixture Mounting Arrangement	Finish	Options			Accessories			
Brand	Product	Number	Design	Shaft Size	Wall Thickness				Mounting Height	Design	Orientation	Height From Base	Design	Orientation	Height From Base

### mounting type

AB = Anchor Base  
EMB = Embedded (Direct Burial)

### fixture mounting arrangement

D1	D4
D2@90	T2
D2@180	T2.5
D3@90	T3
D3@120*	T4

### finish

WH = White  
TWH = Textured White  
DB = Dark Bronze  
TMB = Textured Medium Bronze  
HB = Harvest Bronze  
NB = New Bronze  
SL = Silver  
MGY = Medium Gray  
GR = Gray  
TGR = Textured Gray  
GM = Graphite Metallic  
DP = Dark Platinum  
MA = Matte Aluminum  
PSP = Platinum Silver  
BK = Black  
TBK = Textured Black  
MG = Moss Green

### options

CMB = Camera Mounting Bracket  
CMP = Camera Mounting Plate  
WB-15 = Mounting Bracket  
WC = Welded Coupling (denote size)  
WN = Welded Nipple (denote size)  
Festoon = Festoon Provision  
CSBC = Custom Steel Base Cover  
VD = Vibration Dampener  
GFCI/IUC = Ground Fault Circuit Interrupter with In-Use Cover  
UL = UL Listed

Note: N/A = Not Applicable

### accessories

TB = Transformer Base\*  
ABS-BC = ABS Base Cover\*  
LW = Lowering Winch  
LW-ELECTRIC = Electric Lowering Winch  
BA = Banner Arm  
FH = Flag Holder  
PTTA = Pole Top Tenon Adapter\*

\*Round poles only

Refer to the Mounting Orientation Guide on the next page of this file.

Contact us for custom colors.

\*See our online product catalog for complete catalog numbers of these options and accessories.

\*\* UL Listed labeling is available for catalog steel and aluminum poles—both Commercial & Industrial and Roadway. UL Listed labeling is not available for brackets. UL Listing must be specified at the time of order.