

POLE SHAFT SPECIFICATIONS				
1.	SHAFTS ARE ONE SECTION DESIGN FABRICATED FROM 6063 T6 ALUMINUM EXTRUSION.			
2.	BASE CASTING IS 356 T6 ALUMINUM. THE SHAFT TELESCOPES INTO THE BASE CASTING AND IS CIRCUMFERENTIALLY WELDED TOP AND BOTTOM.			
3.	ANCHOR BOLTS ARE "L" FORMED RODS HAVING A MINIMUM YIELD STRENGTH OF 55,000 P.S.I. FABRICATED FROM ASTM F1554 GR. 55 AND FULLY GALVANIZED PER ASTM 153 SPECIFICATIONS AND FURNISHED COMPLETE WITH 2 HEX NUTS AND 2 FLAT WASHERS.			
4.	POLES SHALL HAVE A POLYESTER POWDER COAT FINISH IN A STANDARD COLOR.			
POLE DIMENSIONS				
POLE HGT. (FT.)	TOP DIA. (IN.)	BOTTOM DIA. (IN.)	GAGE	MTG. HGT. (FT.)
14'	5.00	5.00	.188	14'
BASE PLATE DIMENSIONS				
BOLT CIRCLE (IN.)	BASE PLATE DIM. (IN.)	BOLT HOLE (IN.)	PLATE THK. (IN.)	
7.75	10.62	.88	.75	
ANCHOR BOLT DIMENSIONS				
ANCHOR BOLT DIA. (IN.)		ANCHOR BOLT LENGTH (IN.)		
.75		20.00		
ALLOWABLE WIND LOADING (SQ. FT.)				
WIND*	80 MPH	90 MPH	100 MPH	120 MPH
EPA	13.9	10.7	8.1	5.5

*WITH 1.3 GUST FACTOR

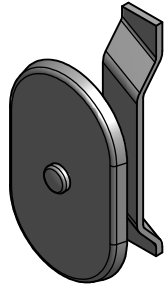

3.00 X 5.00 HAND HOLE COVER

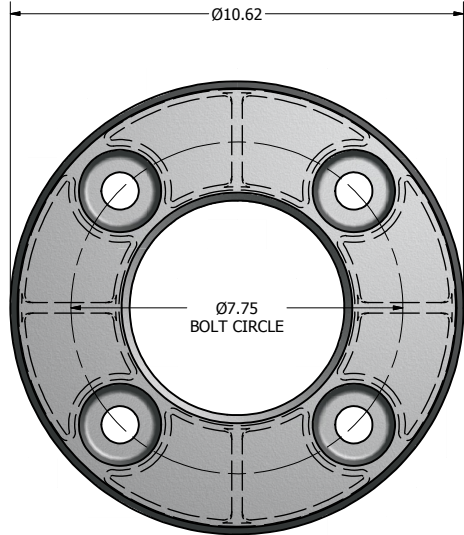

Ø10.62 X 1.88 THK. BASE CASTING

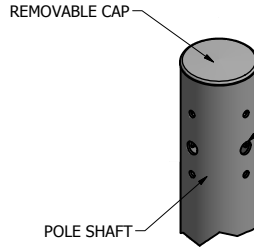

DRILLED MOUNT OPTIONS

- DRILLED PER FIXTURE REQUIREMENTS:
 D1- DRILLED FOR 1 FIXTURE
 D2- DRILLED FOR 2 FIXTURES AT 90° OR 180°
 D3- DRILLED FOR 3 FIXTURES AT 90° OR 120°
 D4- DRILLED FOR 4 FIXTURES

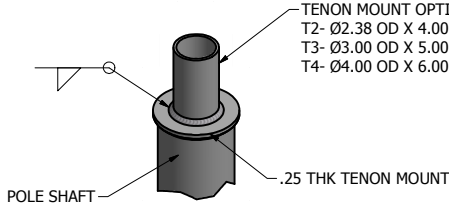

TENON MOUNT OPTIONS

- TENON MOUNT OPTIONS:
 T2- Ø2.38 OD X 4.00 LG
 T3- Ø3.00 OD X 5.00 LG
 T4- Ø4.00 OD X 6.00 LG

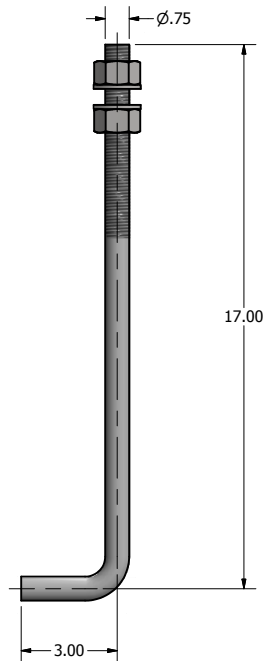

Ø.75 X 20.00 ANCHOR BOLT

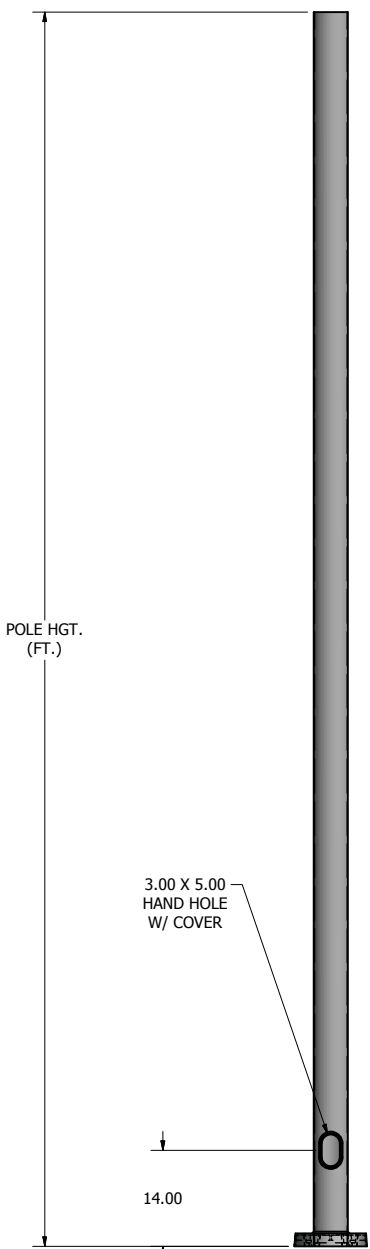

POLE DETAIL

lyte poles
 a DWM company
 P.O. Box 340
 Eastpointe, MI 48021
 P: (586) 771-4610 | F: (586) 771-5527
 www.lytepoles.com

DRAWN: M. HARVALA	2/13/2015
CHECKED:	
REVISION:	DATE:
APPROVED:	
QUOTE:	
S.O.#	
REF:	SCALE: NONE

SOME GEOGRAPHICAL AREAS HAVE SPECIAL WIND CONDITIONS THAT CAN CREATE WIND INDUCED VIBRATIONS CAUSING A FATIGUE PROBLEM. NO METHOD HAS YET BEEN FOUND FOR PREDICTING DESTRUCTIVE LIGHTING POLE VIBRATION. THESE CONDITIONS ARE UNIQUE AND CANNOT BE GUARANTEED AGAINST, AND ARE THE RESPONSIBILITY OF A LOCAL SITE ENGINEER.	
TITLE:	
CATALOG:	
DWG NO: 205-5018-14	SIZE C
SHEET 1 OF 1	

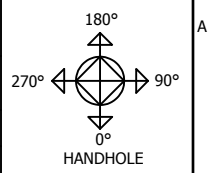

example order number

Fixture			Catalog Number			Mounting Type	Fixture Mounting Arrangement	Finish	Options			Accessories			
Brand	Product	Number	Design	Shaft Size	Wall Thickness				Mounting Height	Design	Orientation	Height From Base	Design	Orientation	Height From Base
			101	40	11	20	AB	T2	DB	WB-15	@90	10'	FH	@180	9'

build your order number

Fixture			Catalog Number			Mounting Type	Fixture Mounting Arrangement	Finish	Options			Accessories			
Brand	Product	Number	Design	Shaft Size	Wall Thickness				Mounting Height	Design	Orientation	Height From Base	Design	Orientation	Height From Base

mounting type

AB = Anchor Base
EMB = Embedded (Direct Burial)

fixture mounting arrangement

D1	D4
D2@90	T2
D2@180	T2.5
D3@90	T3
D3@120*	T4

finish

WH = White
TWH = Textured White
DB = Dark Bronze
TMB = Textured Medium Bronze
HB = Harvest Bronze
NB = New Bronze
SL = Silver
MGY = Medium Gray
GR = Gray
TGR = Textured Gray
GM = Graphite Metallic
DP = Dark Platinum
MA = Matte Aluminum
PSP = Platinum Silver
BK = Black
TBK = Textured Black
MG = Moss Green

options

CMB = Camera Mounting Bracket
CMP = Camera Mounting Plate
WB-15 = Mounting Bracket
WC = Welded Coupling (denote size)
WN = Welded Nipple (denote size)
Festoon = Festoon Provision
CSBC = Custom Steel Base Cover
VD = Vibration Dampener
GFCI/IUC = Ground Fault Circuit Interrupter with In-Use Cover
UL = UL Listed

Note: N/A = Not Applicable

accessories

TB = Transformer Base*
ABS-BC = ABS Base Cover*
LW = Lowering Winch
LW-ELECTRIC = Electric Lowering Winch
BA = Banner Arm
FH = Flag Holder
PTTA = Pole Top Tenon Adapter*

*Round poles only

Refer to the Mounting Orientation Guide on the next page of this file.

Contact us for custom colors.

*See our online product catalog for complete catalog numbers of these options and accessories.

** UL Listed labeling is available for catalog steel and aluminum poles—both Commercial & Industrial and Roadway. UL Listed labeling is not available for brackets. UL Listing must be specified at the time of order.