

Lanterra
LED architectural luminaires

Lumière



Nature is the source of our inspiration.



1004 [4.25"]

1003 [3.25"]

1002 [2.5"]

What will you highlight?

Accentuate vibrant landscapes to match the setting.

Enter Lanterra.

The Lumiere Lanterra brings cutting-edge, feature-packed accent lighting that will dramatically showcase any architectural feature, inside or out. Housed in an elegant, precision-machined metal casing, the Lanterra provides a variety of beam distributions, wireless connectivity and integrated options. Lanterra offers three sizes, multiple lumen packages, high efficacy up to 127 lm/w, optical accessories and various mounting options.

Accent | Sign | Pathway | Cylinders



Landscape

Fine-tune your illumination to create dramatic effects.

Subtly accentuate landscape settings with a variety of mounting and positioning options. Convenient field-interchangeable optics allow for uniform illumination to both near and distant subjects. Warm dimming features offer a comforting complement to any indoor or outdoor ambiance.



1004 Wall square integral driver

1003 Surface

1002 Ground

1002 Tree strap



Architectural exterior

Add Beauty, Character and Focus to modern or traditional structures.

Lanterra's versatility allows endless architectural creativity with multiple optical distributions, lumen packages and mountings. Lanterra allows numerous techniques to create contrast and focus, whether highlighting columns, illuminating cove details or uplighting arch ways, Lanterra is a perfect complement to any architectural facade.



9003 Wall square integral driver

1002 Surface

1004 Ground

9004 Wall round remote driver



Architectural interior

Enhance your environment with simple forms and natural materials.

The clean styling of Lanterra features precision machined aluminum and natural metals. The premium 97 CRI accentuates deep, rich colors allowing the luminaire to blend beautifully with its surroundings.



9003 Wall square remote driver

1002 Wall square integral driver

1004 Wall round remote driver

9004 Surface



Pathway & signs

Architectural versatility allows a variety mounting options and applications.

Lanterra's selection of multi-directional, adjustable and stationary pathway & sign fixtures provide practical, attractive and long-lasting solutions to a myriad of commercial and residential applications. Various standard stem lengths are available, as both single and dual head, with signs having extensive 90° elbow options SU1 and SU2 which allows for uniform lighting of the subject without any undue attention to the light source. The surface mounted option (RSM) in pathway eliminates the need for a remote driver making installation easy.

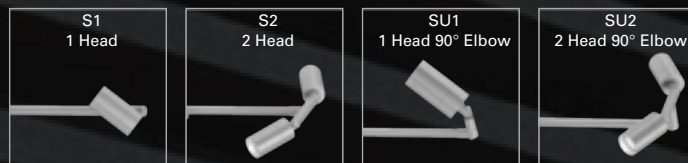

A complete package of optics in one luminaire

Offering field interchangeable optics with four different distributions the Lanterra is an efficient solution for any lighting application. Narrow spot optics offer a great solution for wall grazing along textured surfaces, shooting up vertical columns, or for highlighting a small building detail from afar. Medium and wide floods can assist with a variety of applications for signage, building façades, or large trees.



15° Optics Spot

15°



25° Optics Medium

25°



40° Optics Flood

40°



55° Optics Wide

55°

Optical degree varies for various sizes. Consult specification sheet for details.

Lighting techniques

With so many optics to choose from, any indoor or outdoor area can become an area to attract visitors and guests.

Uplighting

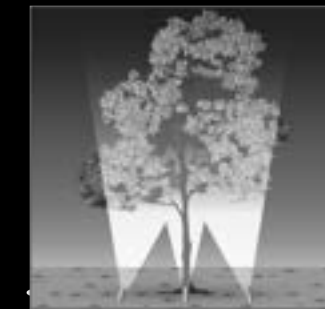

Moonlighting



Cross lighting



Wall washing

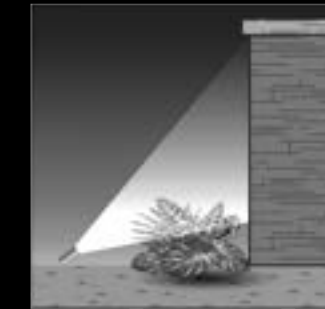

Grazing

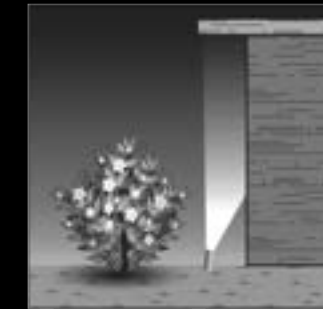

Silhouetting



Path/ Area lighting

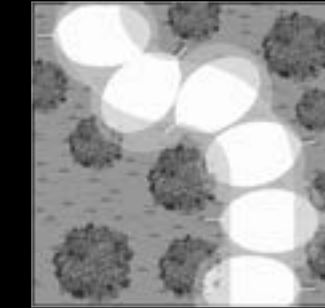

Shadowing

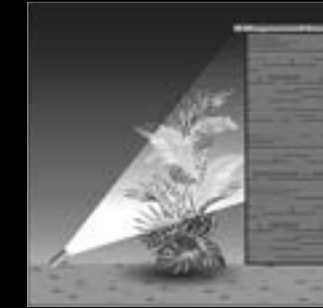

Backlighting



From concept to creation

The best product ideas come from the professionals that use them.

Our fixtures have been developed and refined in collaboration with the lighting design community. This philosophy, coupled with an uncompromising commitment to innovation, quality and value, has produced an impressive roster of patents and industry awards for outstanding fixture design.

Integrated sensor

The Lanterra with integrated sensor provides standalone passive infrared occupancy detection and closed-loop daylight harvesting, enabling enhanced energy savings. With outdoor usage, the sensor will automatically turn off the luminaire when sufficient sunlight is present. Light levels are easily adjusted in the field using the optional programming remote control.

Direct and secure

The Lanterra gives the freedom to focus the light exactly where you need it and allows direction and security of the fixture by using different knuckle styles; the RCS (Rear Center Swivel) allows 180° of tilt angle and 340° of rotation. The SMS (Side Swivel) primarily used for sign and pathway enables the complete 360° of rotation.

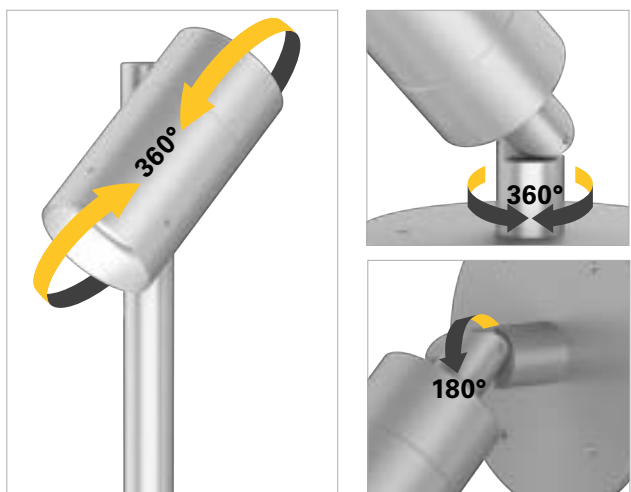

Optical performance

The Lanterra delivers up to 127 lm/w and is available in 3 different light levels: L1 (10W, 1000 lumens*), L2 (20W, 2000 lumens* and L3 (30W, 3000 lumens*). LED's are available in 2700K, 3000K, 3500K at 90CRI and 97CRI, 4000K at 80CRI and 97CRI, 5000K at 80CRI and are industry leading high output with 86% lumen maintenance at 60,000hrs. The long life LED system coupled with electronic driver (120-277V/50-60Hz) is compatible with TRIAC (Leading Edge Dimming), ELV (Trailing Edge Dimming) and 0-10V dimming to deliver optical performance. Light can be dimmed from 100-1% while maintaining constant CCT. It will operate in -30°C to 50°C unless noted otherwise. The driver incorporates surge protection.

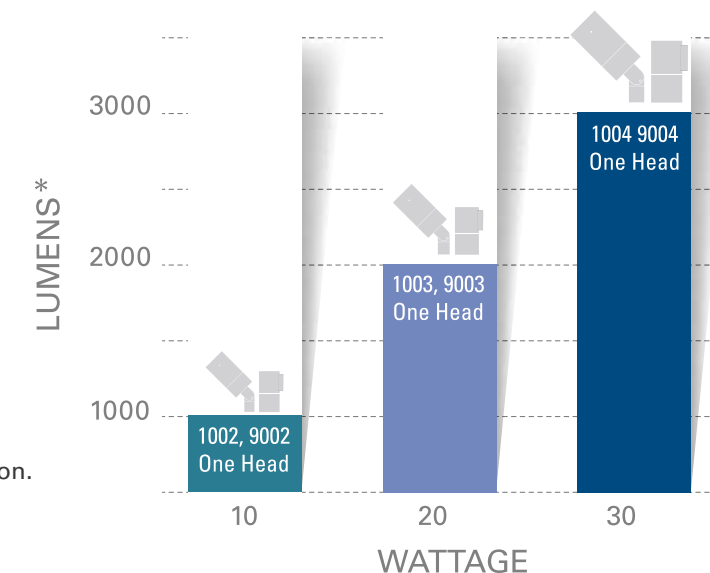

Materials and accessories



We strive to use only the finest materials available. Time-honored architectural materials such as brass, bronze, copper and stainless steel, each selected specifically for their beauty and natural corrosion resistance. Fixtures constructed from these materials also exude a warmth and splendor unlike painted finish. Physical design elements of these materials may be selected to match or compliment other architectural finishes, both indoors and out.

*Nominal lumen values. Exact delivered lumens vary for specific CCT/ optical distribution etc. Refer specification sheets or IES files for details.

Lenses & Louvers	Dichroic Filters
Linear Spread Lens	Peach
Overall Spread Lens	Amber
Diffused Lens	Green
Hex Cell Louver	Medium Blue
	Yellow
	Red
	Dark Blue
	Light Blue
	Neutral Density
	Magenta



Dare to live in color

Colors, like features, follow the changes of the emotions. Pablo Picasso

Whether you are trying to highlight an environment for a holiday or showcase lighting for a special event, Lanterra's premium color tuning feature along with the RF remote or Bluetooth app enables fixture grouping and preset scenes to bring a color element and visual grandeur to any occasion.



Premium color tuning

Lumenetix™

The Lumenetix Araya5 uses color tuning technology and five different LED colors to mimic the range and quality of sunlight. Emulating sunlight is key to maximizing how one sees (visual acuity), looks (visual appeal) and feels (wellness). The Araya5 delivers tunable and dimmable light at 90+ CRI to make subjects, objects and spaces look and feel better. This technology maintains a lifetime color consistency of <2 MacAdam ellipse (+/- 0.002 Duv from the Blackbody Curve) across a tuning range of 1650-4000K. Araya5 can be dimmed from 100-1%, while preserving a constant CCT. It is compatible with 0-10V wired controls, and is offered in Bluetooth (LEDCB), remote controlled (LEDCR) and warm dim color modules (LEDWD).



Remote Controller* can be bought as an Accessory and can combine up to 80 fixtures

2.5" OD

INTERIOR/
EXTERIOR

Lanterra 1002 (2.5") line voltage dimmable LED is available in Accent, Sign and Pathway luminaires with single and dual head configurations. The 1002 Accent features an adjustable rear center swivel with lock rotation. The 1002 Pathway includes an additional side swivel mount, while the 1002 Sign comes with 90° elbow options to meet any desired rotation and vertical adjustment. The luminaire comes with various mounting, field replaceable optics and premium color tuning options. It also includes various lens, louvers and colors or dichroic filters, which can combine up to two at once, creating multiple lighting effects.

ORDERING

SERIES

LAN TERRA 1002

HEAD STYLE

Accent	Pathway	Sign	
A1- 1 Head	P1- 1 Head	S1- 1 Head	SU1- 1 Head 90° elbow
A2- 2 Head	P2- 2 Head	S2- 2 Head	SU2- 2 Head 90° elbow

KNUCKLE STYLE

RCS- Rear center swivel with lock rotation	SMS- Side swivel
---------------------------------------------------	-------------------------

HOOD

RW- Standard - recessed lens with weep holes – Outdoor
RI- Recessed lens with no weep holes – Indoor
FL- Flush lens hood

LED CCT & CRI

Standard	Premium CRI	Premium color tuning
LED2790- 2700K, 90 CRI	LED2797- 2700K, 97 CRI	LEDCB- Bluetooth color module
LED3090- 3000K, 90 CRI	LED3097- 3000K, 97 CRI	LED CR- Remote color module
LED3590- 3500K, 90 CRI	LED3597- 3500K, 97 CRI	LEDWD- Warm dim color module
LED4080- 4000K, 80 CRI	LED4097- 4000K, 97 CRI	
LED5080- 5000K, 80 CRI		

OPTICS

S- Spot	M- Medium	F- Flood	W- Wide flood
----------------	------------------	-----------------	----------------------

STANDARD FINISH

BK	black
BZ	bronze
CS	city silver
WT	Painted white

PREMIUM METAL FINISH

NBR	Natural brass
NBZ	Natural bronze
NCP	Natural copper
NSS	Natural stainless steel

STEM EXTENSION

Accent	Pathway	Sign
None	14", 18", 24"	6", 14", 18", 24", 30", 36"

LIGHT LEVEL

L1- Light level 1, 10W	LC1- Light level color 1, 12W
L2- Light level 2, 20W	LC2- Light level color 2, 20W
L3- Light level 3, 30W	

VOLTAGE

UNV- Universal 120-277

MOUNTINGS

RSM- Round surface mount	WRS- Square wall plate, remote driver housing
MB- Ground mount recessed box	WIS- Wall integral square
WRR- Round wall plate, remote driver housing	TSR2(1-4)- Tree strap mount, (upto 4 heads)

OPTIONS

SVPD2- Integrated sensor



A1-WRR
[WRS also available]

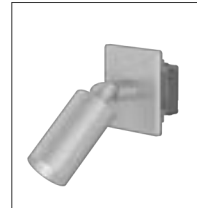

A1-WIS

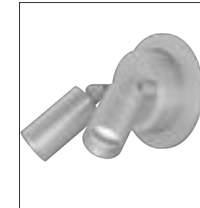

A2-RSM
[Also available in 1 head]



A2-RSM
[Also available in 1 head]

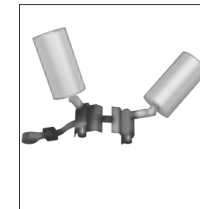

TSR2-2
[Can mount upto 4 heads]

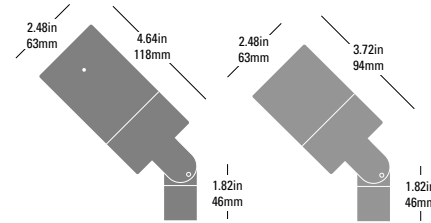

1002-RW

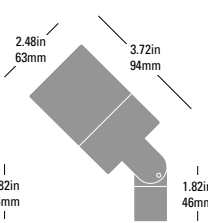

1002-FL

2.5" OD

INTERIOR/
EXTERIOR

Lanterra 9002-W1 (Up or Down) and 9002-W2 (Up and Down) are small 2.5" O.D., line voltage cylinder fixtures with dimmable LED. The luminaires are offered in various mounting options. Surface mount with integral driver in the housing, remote driver mount with round and square wall plates and square wall integral driver can be mounted over standard 4 inch j-box. The 9002 series luminaires include various beam optics, lenses, louvers, colors and dichroic filters that can be combined up to two at once to create multiple lighting effects.

ORDERING

SERIES

LAN TERRA 9002

HEAD STYLE

W1- Up or down
W2- Up or down

HOOD

RW- Standard - recessed lens with weep holes – Outdoor
RI- Recessed lens with no weep holes – Indoor
FL- Flush lens hood

LED CCT & CRI

Standard	Premium CRI	Premium color tuning
LED2790- 2700K, 90 CRI	LED2797- 2700K, 97 CRI	LEDCB- Bluetooth color module
LED3090- 3000K, 90 CRI	LED3097- 3000K, 97 CRI	LED CR- Remote color module
LED3590- 3500K, 90 CRI	LED3597- 3500K, 97 CRI	LEDWD- Warm dim color module
LED4080- 4000K, 80 CRI	LED4097- 4000K, 97 CRI	
LED5080- 5000K, 80 CRI		

OPTICS

S- Spot	M- Medium	F- Flood	W- Wide flood
----------------	------------------	-----------------	----------------------

STANDARD FINISH

BK	black
BZ	bronze
CS	city silver
WT	Painted white

PREMIUM METAL FINISH

NBR	Natural brass
NBZ	Natural bronze
NCP	Natural copper
NSS	Natural stainless steel

LIGHT LEVEL

L1- Light level 1, 10W
L2- Light level 2, 20W
L3- Light level 3, 30W
LC1- Light level color 1, 12W
LC2- Light level color 2, 20W

VOLTAGE

UNV- Universal 120-277

MOUNTINGS

RSM- Round surface mount
WRR- Round wall plate, remote driver housing
WRS- Square wall plate, remote driver housing
WIS- Wall integral square

OPTIONS

SVPD2- Integrated sensor



W1-WIS



W2-WIS

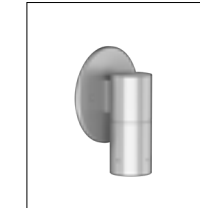

A1-WRR
[WRS also available]

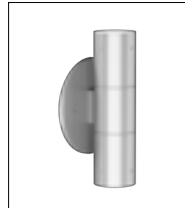

W2-WRR
[WRS also available]

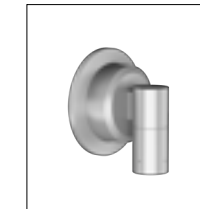

W1-RSM

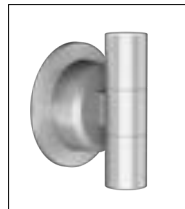

W2-RSM

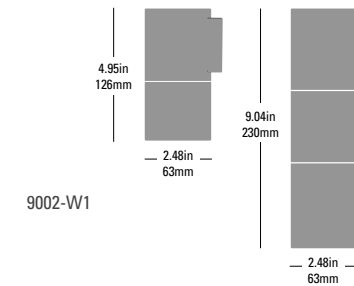

9002-W1

9002-W2
RI hood shown, FL and RW hood also available

Refer to specification sheets for all technical notes, exceptions & latest information. ies files for all optics are available online



DesignLights Consortium®
Qualified
www.designlights.org



DesignLights Consortium®
Qualified
www.designlights.org

3.25" OD

INTERIOR/
EXTERIOR

Lanterra 1003 (3.5") line voltage dimmable LED is available in Accent, Sign and Pathway luminaires with single and dual head configurations. The 1003 Accent features an adjustable rear center swivel with lock rotation, while the 1003 Sign offers 90° options to meet any desired rotation and vertical adjustment. The luminaire comes with various mounting, field replaceable optics and premium color tuning options. It also includes various lens, louvers and colors or dichroic filters, which can combine up to two at once, creating multiple lighting effects.

ORDERING

SERIES

LAN TERRA 1003

HEAD STYLE

Accent	Sign	
A1- 1 Head	S1- 1 Head	SU1- 1 Head 90° elbow
A2- 2 Head	S2- 2 Head	SU2- 2 Head 90° elbow

KNUCKLE STYLE

RCS- Rear center swivel with lock rotation **SMS-** Side swivel

HOOD

RW- Standard - recessed lens with weep holes – Outdoor
RI- Recessed lens with no weep holes – Indoor
FL- Flush lens hood

LED CCT & CRI

Standard	Premium CRI	Premium color tuning
LED2790- 2700K, 90 CRI	LED2797- 2700K, 97 CRI	LEDCB- Bluetooth color module
LED3090- 3000K, 90 CRI	LED3097- 3000K, 97 CRI	LEDCR- Remote color module
LED3590- 3500K, 90 CRI	LED3597- 3500K, 97 CRI	LEDWD- Warm dim color module
LED4080- 4000K, 80 CRI	LED4097- 4000K, 97 CRI	
LED5080- 5000K, 80 CRI		

OPTICS

S- Spot **M-** Medium **F-** Flood **W-** Wide flood

STANDARD FINISH

BK	black
BZ	bronze
CS	city silver
WT	Painted white

PREMIUM METAL FINISH

NBR	Natural brass
NBZ	Natural bronze
NCP	Natural copper
NSS	Natural stainless steel

STEM EXTENSION

Accent	Sign
None	6", 14", 18", 24", 30", 36"

LIGHT LEVEL

L1- Light level 1, 10W	LC1- Light level color 1, 12W
L2- Light level 2, 20W	LC2- Light level color 2, 20W
L3- Light level 3, 30W	

VOLTAGE

UNV- Universal 120-277

MOUNTINGS

RSM- Round surface mount	WRS- Square wall plate, remote driver housing
MB- Ground mount recessed box	WIS- Wall integral square
WRR- Round wall plate, remote driver housing	TSR2(1-4)- Tree strap mount, (upto 4 heads)

OPTIONS

SVPD2- Integrated sensor



A1-WIS



A1-WRR
[WRS also available]



A2-RSM
[also available in 1 head]

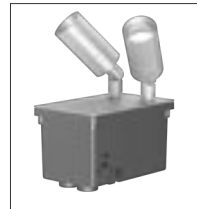

A2-MB
[also available in 1 head]

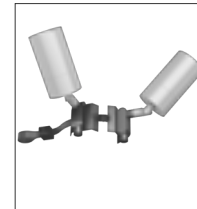

TSR2-2
[can mount up to 4 heads]

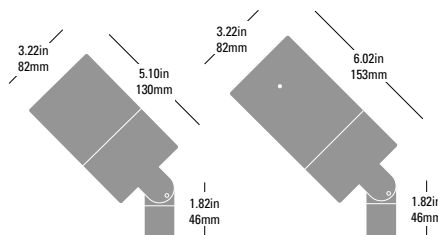

1003-RW

1003-FL



W1-WRR

W2-WRR

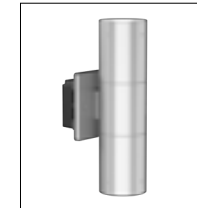

A1-WIS
[WRS also available]

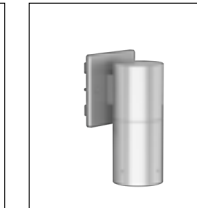

W2-WIS
[WRS also available]

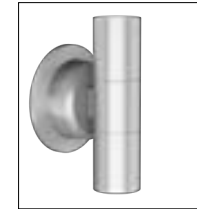

W1-RSM

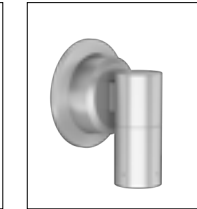

W2-RSM

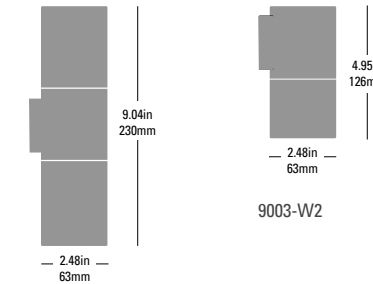

9003-W1

9003-W2

3.25" OD

INTERIOR/
EXTERIOR

Lanterra 9003-W1 (Up or Down) and 9002-W2 (Up and Down) are 3.25" O.D., line voltage cylinder fixtures with dimmable LED. The luminaires are offered in various mounting options. Surface mount with integral driver in the housing, remote driver mount with round and square wall plates and square wall integral driver can be mounted over standard 4 inch j-box. The 9002 series luminaires include various beam optics, lenses, louvers, colors and dichroic filters that can be combined up to two at once to create multiple lighting effects.

ORDERING

SERIES

LAN TERRA 9003

HEAD STYLE

W1- Up or down
W2- Up or down

HOOD

RW- Standard - recessed lens with weep holes – Outdoor
RI- Recessed lens with no weep holes – Indoor
FL- Flush lens hood

LED CCT & CRI

Standard	Premium CRI	Premium color tuning
LED2790- 2700K, 90 CRI	LED2797- 2700K, 97 CRI	LEDCB- Bluetooth color module
LED3090- 3000K, 90 CRI	LED3097- 3000K, 97 CRI	LEDCR- Remote color module
LED3590- 3500K, 90 CRI	LED3597- 3500K, 97 CRI	LEDWD- Warm dim color module
LED4080- 4000K, 80 CRI	LED4097- 4000K, 97 CRI	
LED5080- 5000K, 80 CRI		

OPTICS

S- Spot **M-** Medium **F-** Flood **W-** Wide flood

STANDARD FINISH

BK	black
BZ	bronze
CS	city silver
WT	Painted white

LIGHT LEVEL

L1- Light level 1, 10W
L2- Light level 2, 20W
L3- Light level 3, 30W
LC1- Light level color 1, 12W
LC2- Light level color 2, 20W

VOLTAGE

UNV- Universal 120-277

MOUNTINGS

RSM- Round surface mount
WRR- Round wall plate, remote driver housing
WRS- Square wall plate, remote driver housing
WIS- Wall integral square

OPTIONS

SVPD2- Integrated sensor

Refer to specification sheets for all technical notes, exceptions & latest information. ies files for all optics are available online.



DesignLights Consortium®
Qualified
www.designlights.org



DesignLights Consortium®
Qualified
www.designlights.org

LANTERRA

1004 SERIES

4.25" OD

INTERIOR/
EXTERIOR

Lanterra 1004 (4.25") line voltage dimmable LED is available as an Accent Light with a single head configuration. The luminaire features an adjustable rear center swivel with lock rotation, which provides a 180° tilt and 340° rotation. The 1004 series comes with various mounting, field replaceable optics and premium color tuning options. It also includes various lens, louvers and colors or dichroic filters, which can combine up to two at once to create multiple lighting effects.

ORDERING

SERIES

LANTERRA 1004

HEAD STYLE

Accent

A1- 1 Head

A2- 2 Head

KNUCKLE STYLE

RCS- Rear center swivel with lock rotation

SMS- Side swivel

HOOD

RW- Standard - recessed lens with weep holes – Outdoor

RI- Recessed lens with no weep holes – Indoor

FL- Flush lens hood

LED CCT & CRI

Standard

LED2790- 2700K, 90 CRI

LED3090- 3000K, 90 CRI

LED3590- 3500K, 90 CRI

LED4080- 4000K, 80 CRI

LED5080- 5000K, 80 CRI

Premium CRI

LED2797- 2700K, 97 CRI

LED3097- 3000K, 97 CRI

LED3597- 3500K, 97 CRI

LED4097- 4000K, 97 CRI

Premium color tuning

LEDCB- Bluetooth color module

LEDCR- Remote color module

LEDWD- Warm dim color module

OPTICS

S-Spot

M-Medium

F-Flood

W-Wide flood

STANDARD FINISH

BK black

BZ bronze

CS city silver

WT Painted white

LIGHT LEVEL

L1- Light level 1, 10W

L2- Light level 2, 20W

L3- Light level 3, 30W

LC1- Light level color 1, 12W

LC2- Light level color 2, 20W

VOLTAGE

UNV-Universal 120-277

MOUNTINGS

RSM- Round surface mount

MB- Ground mount recessed box

WRR- Round wall plate, remote driver housing

WRS- Square wall plate, remote driver housing

WIS- Wall integral square

TSR2(1-4)- Tree strap mount, (upto 4 heads)

OPTIONS

SVPD2- Integrated sensor

Refer to specification sheets for all technical notes, exceptions & latest information. ies files for all optics are available online.



A2-RSM



A1-WIS

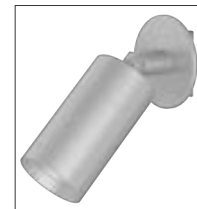

A1-WRR
(WRS also available)

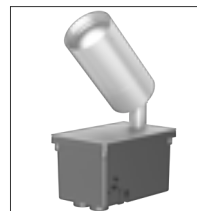

A2-MB

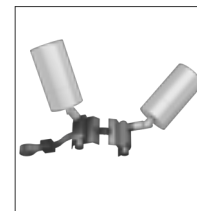

TSR2-2
(can mount upto 4 heads)

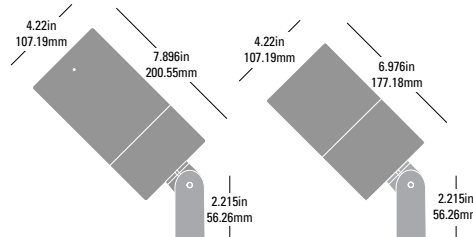

1003-RW

1003-FL



W1-RSM

W2-RSM



W1-WRR
(WRS also available)

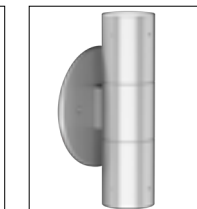

W2-WRR
(WRS also available)

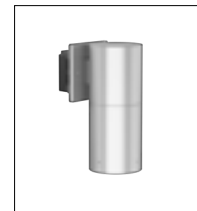

W1-WIS

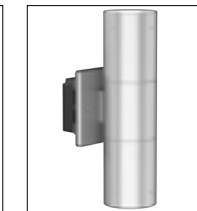

W2-WIS

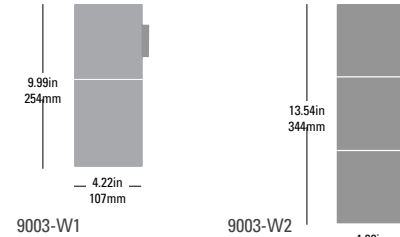

9003-W1

9003-W2

[RI hood shown, FL and RW hood also available]

9004 SERIES

LANTERRA

4.25" OD

INTERIOR/
EXTERIOR

Lanterra 9004-W1 (Up or Down) and 9004-W2 (Up and Down) are 4.25" O.D., line voltage cylinder fixtures with dimmable LED. The luminaires are offered in various mounting options. Surface mount with integral driver in the housing, remote driver mount with round and square wall plates and square wall integral driver can be mounted over standard 4 inch j-box. The 9002 series luminaires include various beam optics, lenses, louvers, colors and dichroic filters that can be combined up to two at once to create multiple lighting effects.

ORDERING

SERIES

LANTERRA 9004

HEAD STYLE

W1- Up or down

W2- Up or down

HOOD

RW- Standard - recessed lens with weep holes – Outdoor

RI- Recessed lens with no weep holes – Indoor

FL- Flush lens hood

LED CCT & CRI

Standard

LED2790- 2700K, 90 CRI

LED3090- 3000K, 90 CRI

LED3590- 3500K, 90 CRI

LED4080- 4000K, 80 CRI

LED5080- 5000K, 80 CRI

Premium CRI

LED2797- 2700K, 97 CRI

LED3097- 3000K, 97 CRI

LED3597- 3500K, 97 CRI

LED4097- 4000K, 97 CRI

Premium color tuning

LEDCB- Bluetooth color module

LEDCR- Remote color module

LEDWD- Warm dim color module

OPTICS

S- Spot

M- Medium

F- Flood

W- Wide flood

STANDARD FINISH

BK black

BZ bronze

CS city silver

WT Painted white

LIGHT LEVEL

L1- Light level 1, 10W

L2- Light level 2, 20W

L3- Light level 3, 30W

LC1- Light level color 1, 12W

LC2- Light level color 2, 20W

VOLTAGE

UNV- Universal 120-277

MOUNTINGS

RSM- Round surface mount

WRR- Round wall plate, remote driver housing

WRS- Square wall plate, remote driver housing

WIS- Wall integral square

OPTIONS

SVPD2- Integrated sensor

Refer to specification sheets for all technical notes, exceptions & latest information. ies files for all optics are available online.



IP66



DesignLights Consortium®
Qualified
www.designlights.org



IP66



DesignLights Consortium®
Qualified
www.designlights.org

Lighting Brands

Ametrix
AtLite
Corelite
Ephesus
Fail-Safe
Halo
Halo Commercial
Invue
io
Iris
Lumark
Lumière
McGraw-Edison
Metalux
MWS
Neo-Ray
Portfolio
RSA
Shaper
Streetworks
Sure-Lites

Controls Brands

Greengate
Fifth Light

Connected Lighting Systems

HALO Home
WaveLinx

IoT Platforms

Trellix

Cooper Lighting Solutions

1121 Highway 74 South
Peachtree City, GA 30269
P: 770-486-4800
www.cooperlighting.com

Canada Sales
5925 McLaughlin Road
Mississauga, Ontario L5R 1B8
P: 905-501-3000
F: 905-501-3172

© 2021 Cooper Lighting Solutions
All Rights Reserved
Printed in USA
Publication No. BR509002EN
March 2021

Cooper Lighting Solutions is a registered trademark.

All other trademarks are property of their respective owners.

Product availability, specifications, and compliances are subject to change without notice.

