

Lumiere

DESCRIPTION

Lanterra 1002-P1 (one head) and 1002-P2 (2 head) is a small 2.5 O.D., line voltage Path light with dimmable LED. Each model attaches to an extended length-mounting stem. The side swivel mount on P1 gives 360° rotation while the center swivel mount on P2 adds to 180° tilt along with the 360° rotation. The luminaire comes with various mounting, field replaceable optics and premium color tuning options. It also comes with various lens, louvers and colors or dichroic filters which can combine up to two at once to create multiple lighting effects. The fixture may be used indoors or outdoors and carries IP66 rating.

SPECIFICATION FEATURES

Material

Housing, hood and mounting stem are precision-machined from corrosion resistant billet stock 6061-T6 aluminum.

Finish

Fixtures constructed from 601-T6 aluminum are double protected by an ROHS complaint chemical film undercoating and polyester powder coat paint finish, surpassing the rigorous demands of the outdoor environment. A variety of standard colors are available.

Hood

Hood is removable and accepts up to two internal accessories at once (lenses, louvers and filters) to achieve multiple lighting effects. Weep holes prevents water and mineral stains from collecting on the lens, even in the straight up position. The flush lens design reduces fixture length, minimizes debris collection and prevents water and mineral stains from collecting on the lens.

Gasket

Housing and hood are sealed with a high

temperature silicone O-ring gasket to prevent water intrusion.

Lens

Tempered glass lens, factory sealed with high temperature silicone O-ring to prevent water intrusion and breakage due to thermal shock.

Hardware

Stainless steel hardware is standard to provide maximum corrosion resistance.

Electrical

Long life LED system coupled with electronic driver (120-277V/50-60Hz) is compatible with TRIAC (Leading Edge Dimming), ELV (Trailing Edge Dimming) and 0-10V dimming to deliver optical performance. Light can be dimmed from 100-1% while maintaining constant CCT. It will operate in -30°C to 50°C unless noted otherwise. The driver incorporates surge protection. LED's are available in 2700K, 3000K, 3500K at 90CRI and 97CRI, 4000K at 80CRI and 97CRI, 5000K at 80CRI and are industry leading high output with 86% lumen maintenance at 60,000hrs.

Compliance

Components are UL recognized and luminaires are cULus listed for 50°C ambient environments unless noted otherwise, wet location listed, and ROHS compliant. IP66 Rated. Options to meet Buy American Act requirements.

Warranty

Lumiere warrants the Lanterra series of fixtures against defects in material and workmanship for five (5) years. Auxiliary equipment such as LED drivers carries the original manufacturer's warranty.

DIMENSIONS

RW HOOD

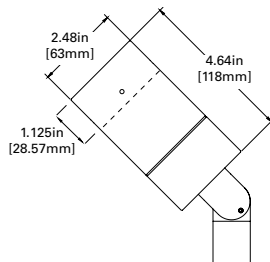

FL HOOD

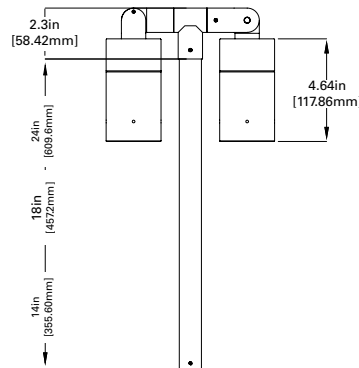
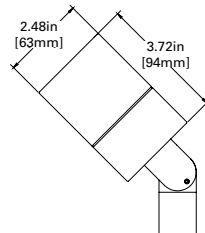

ORDERING INFORMATION

DOMESTIC PREFERENCES ¹	SERIES	NUMBER OF HEADS	HOOD	LED CCT & CRI	FIELD REPLACEABLE OPTIC	FINISH	STEM LENGTH	LIGHT LEVEL	VOLTAGE	MOUNTING
[Blank]=Standard BAA=Buy American Act	1002	P1 1 Head P2 ³ 2 Head	RW Standard-Recessed Lens with weep holes - Outdoor FL Flush lens hood	Standard CRI LED2790 - 2700K, 90 CRI LED 3090 - 3000K, 90 CRI LED 3590 - 3500K, 90 CRI LED 4080 - 4000K, 80 CRI LED 5080 - 5000K, 80 CRI Premium CRI LED 2797 - 2700K, 97 CRI LED 3097 - 3000K, 97 CRI LED 3597 - 3500K, 97 CRI LED 4097 - 4000K, 97 CRI	S Spot M Medium F Flood W Wide	Standard Paint Finish BK Black BZ Bronze CS City Silver WT White	14 14" Stem 18 18" Stem 24 24" Stem	L1 Light Level 1 (10W) LC1 ² Light Level Color 1 (12W)	UNV 120-277V	RSM Round Surface Mount - mounts directly to junction box

Notes: 1. Order LC remote separately 2. LC1 limited to F and W optic only 3. P2 doubles input wattage listed 4 Only available for LEDCR 5.Only product configurations with this designated prefix are built to be compliant with the Buy American Act of 1933 (BAA). Please refer to DOMESTIC PREFERENCES website for more information. Components shipped separately may be separately analyzed under domestic preference requirements. 6. Accessories sold separately will be separately analyzed under domestic preference requirements. Consult factory for further information.

Catalog #		Type	
Project			
Comments		Date	
Prepared by			



Lanterra 1002



LED
INTERIOR / EXTERIOR
PATHWAY FLOOD LIGHT
CERTIFICATION DATA
cULus - 1598
Wet Location Listed - IP66
LM79/LM80 Compliant
ROHS Compliant
10W LED, L70/90,000@25° Celcius

ACCESSORIES - ORDER SEPARATELY

ACCESSORIES ⁶		OPTICS		
LCTL1RZRT452L-PK ⁴ Light Commissioning Tool (LCT)	Filters F71-2 Peach Dichroic F72-2 Amber Dichroic F73-2 Green Dichroic F74-2 Medium Blue F75-2 Yellow Dichroic F76-2 Red Dichroic F77-2 Dark Blue Dichroic F78-2 Light Blue Dichroic F79-2 Neutral Density Dichroic F80-2 Magenta Dichroic F22-2 Red Color F33-2 Blue Color F44-2 Green Color F55-2 Yellow Color F66-2 Mercury Color	Lens LSL-2 Linear Spread Lens DIF-2 Diffused Lens OSL-2 Overall Spread Lens	Louvers LVR-2 45° Hex Cell Louver	LLR-S-2 15° Spot LLR-M-2 25° Medium LLR-F-2 40° Flood LLR-W-2 55° Wide Flood LLR-K-2 Spot, Medium, Flood, Wide Flood kit LLR-F-LC-2 40° Flood color tuning optic LLR-W-LC-2 55° Wide Flood color tuning optic LLR-K-LC-2 Flood, Wide Flood tuning optic kit

MOUNTINGS

ROUND SURFACE MOUNT (RSM)

P1 (1 Head)
TOP VIEW

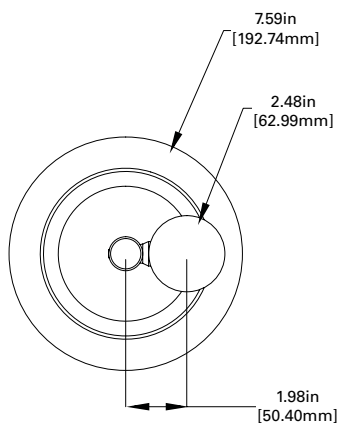

FRONT VIEW

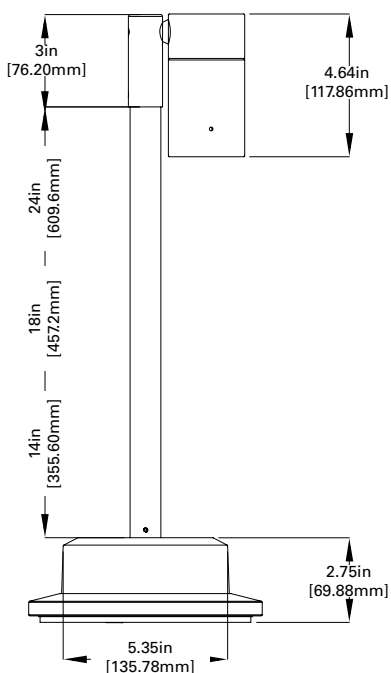

ISO VIEW

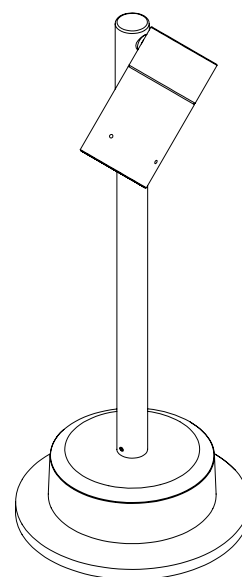

ROUND SURFACE MOUNT (RSM)

P2 (2 Head)
TOP VIEW

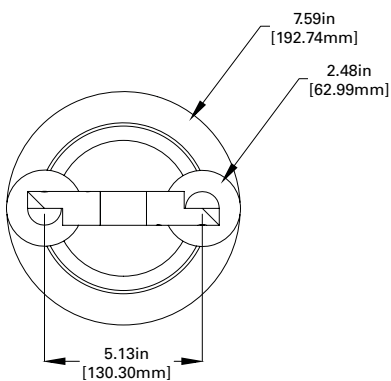

FRONT VIEW

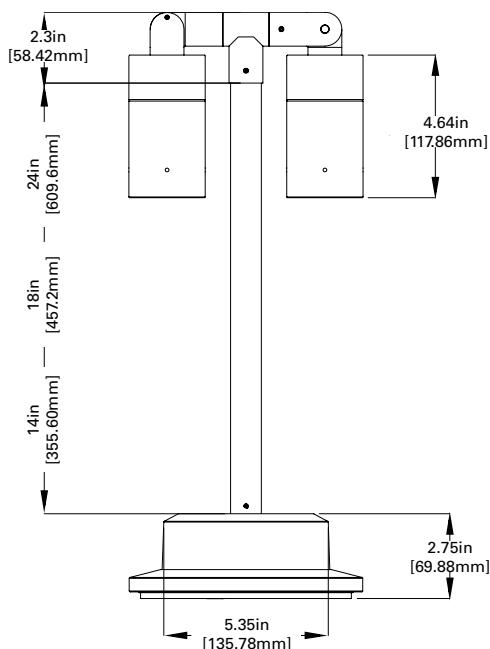

ISO VIEW

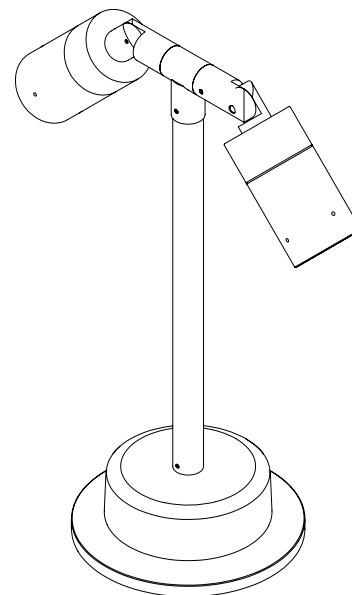

PHOTOMETRICS

Test Number	P29421
Lumcat	1002-[A1, P1, S1, SU1, W1]-X-FL-LED4080-S-BK-L1-UNV
Lumens	458 Lm
Watts	10 W
LPW	45.8 Lm/W
CCT	4000K
SC (0/90/45)	0.24 / 0.24 / 0.24
Beam Angle	14°

COLOR METRIC SUMMARY	
TM-30-15	Rf = 82.6 Rg = 93.8
CRI/CIE	Ra = 84.2 R9 = 15.1

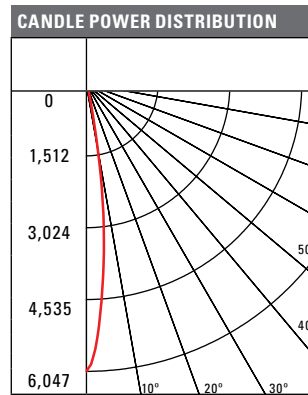
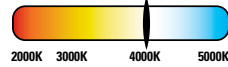

CONE OF LIGHT				
Horizontal Illuminance on Floor				
MH	FC	L	W	
2'	1511.8	0.4	0.4	
4'	377.9	0.8	0.8	
6'	168	1.4	1.4	
8'	94.5	1.8	1.8	
10'	60.5	2.4	2.4	
15'	26.9	3.6	3.6	
20'	15.1	4.8	4.8	
30'	6.7	7.2	7.2	
40'	3.8	9.6	9.6	

CANDELA TABLE		
Angle	0-deg	
0	6047	
5	4064	
10	1430	
15	292	
20	137	
30	21	
40	7	
50	3	
60	2	
70	1	
80	0	
90	0	

Test Number	P29422
Lumcat	1002-[A1, P1, S1, SU1, W1]-X-FL-LED4080-M-BK-L1-UNV
Lumens	985 Lm
Watts	10 W
LPW	98.5 Lm/W
CCT	4000K
SC (0/90/45)	0.4 / 0.4 / 0.36
Beam Angle	23.1°

COLOR METRIC SUMMARY	
TM-30-15	Rf = 82.6 Rg = 93.8
CRI/CIE	Ra = 84.2 R9 = 15.1

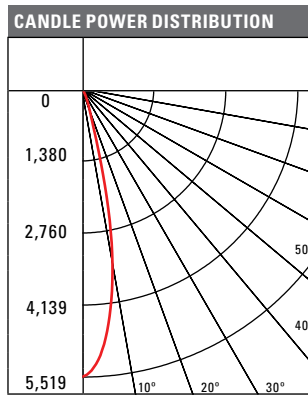
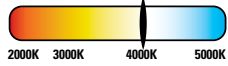

CONE OF LIGHT				
Horizontal Illuminance on Floor				
MH	FC	L	W	
2'	1379.8	0.6	0.6	
4'	344.9	1.4	1.4	
6'	153.3	2.2	2.2	
8'	86.2	3	3	
10'	55.2	3.8	3.8	
15'	24.5	5.8	5.8	
20'	13.8	7.8	7.8	
30'	6.1	11.8	11.8	
40'	3.4	15.8	15.8	

CANDELA TABLE		
Angle	0-deg	
0	5519	
5	4909	
10	3391	
15	1302	
20	457	
30	133	
40	22	
50	6	
60	2	
70	1	
80	0	
90	0	

Test Number	P29423
Lumcat	1002-[A1, P1, S1, SU1, W1]-X-FL-LED4080-F-BK-L1-UNV
Lumens	1015 Lm
Watts	10W
LPW	101.5 Lm/W
CCT	4000K
SC (0/90/45)	0.66 / 0.66 / 0.63
Beam Angle	40.3°

COLOR METRIC SUMMARY	
TM-30-15	Rf = 82.6 Rg = 93.8
CRI/CIE	Ra = 84.2 R9 = 15.1

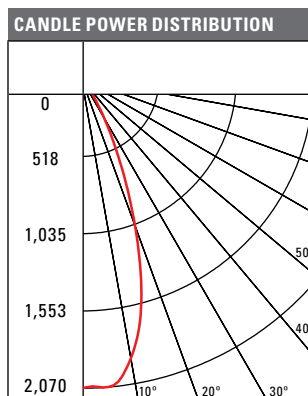
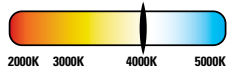

CONE OF LIGHT				
Horizontal Illuminance on Floor				
MH	FC	L	W	
2'	517.5	1.2	1.2	
4'	129.4	2.6	2.6	
6'	57.5	3.8	3.8	
8'	32.3	5.2	5.2	
10'	20.7	6.6	6.6	
15'	9.2	9.8	9.8	
20'	5.2	13.2	13.2	
30'	2.3	19.8	19.8	
40'	1.3	26.4	26.4	

CANDELA TABLE		
Angle	0-deg	
0	2070	
5	2070	
10	1900	
15	1547	
20	1048	
30	306	
40	60	
50	11	
60	3	
70	2	
80	0	
90	0	

Test Number	P29424
Lumcat	1002-[A1, P1, S1, SU1, W1]-X-FL-LED4080-W-BK-L1-UNV
Lumens	947 Lm
Watts	10 W
LPW	94.7 Lm/W
CCT	4000K
SC (0/90/45)	0.87 / 0.87 / 0.88
Beam Angle	57.1°

COLOR METRIC SUMMARY	
TM-30-15	Rf = 82.6 Rg = 93.8
CRI/CIE	Ra = 84.2 R9 = 15.1

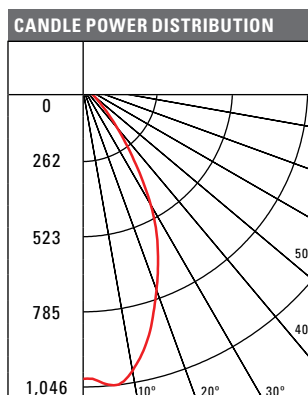
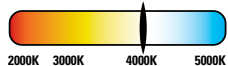

CONE OF LIGHT				
Horizontal Illuminance on Floor				
MH	FC	L	W	
2'	257.5	1.6	1.6	
4'	64.4	3.4	3.4	
6'	28.6	5	5	
8'	16.1	6.8	6.8	
10'	10.3	8.6	8.6	
15'	4.6	12.8	12.8	
20'	2.6	17.2	17.2	
30'	1.1	25.8	25.8	
40'	0.6	34.4	34.4	

CANDELA TABLE		
Angle	0-deg	
0	1018	
5	1042	
10	1005	
15	896	
20	754	
30	477	
40	189	
50	56	
60	13	
70	2	
80	0	
90	0	

CCT/CRI	LED2790	LED3090	LED3590	LED4080	LED5080	LED2797	LED3097	LED3597	LED4097
FC Multiplier	0.757	0.802	0.869	1.000	1.092	0.722	0.773	0.813	0.833

PHOTOMETRICS (PREMIUM COLOR TUNING)

Test Number	P29548
Lumcat	1002-[A1, P1, S1, SU1, W1]-X-FL-[LEDCB, LEDCR]-F-BK-LC-UNV
Lumens	467 Lm
Watts	13.5 W
LPW	34.6 Lm/W
CCT	3500K
SC (0/90/45)	0.68 / 0.68 / 0.62
Beam Angle	40.6°
Module set to 3500K CCT, 100% output	

COLOR METRIC SUMMARY	
TM-30-15	Rf = 90.4 Rg = 98.7
CRI/CIE	Ra = 92.5 R9 = 65.5

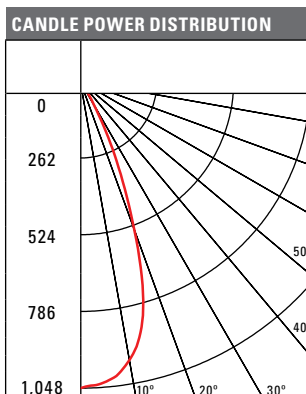
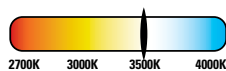

CONE OF LIGHT			
Horizontal Illuminance on Floor			
MH	FC	L	W
2'	262	1.2	1.2
4'	65.5	2.6	2.6
6'	29.1	4	4
8'	16.4	5.4	5.4
10'	10.5	6.8	6.8
15'	4.7	10.2	10.2
20'	2.6	13.6	13.6
30'	1.2	20.4	20.4
40'	0.7	27.2	27.2

CANDELA TABLE	
Angle	0-deg
0	1048
5	1029
10	967
15	828
20	541
30	99
40	2
50	1
60	1
70	0
80	0
90	0

Test Number	P29549
Lumcat	1002-[A1, P1, S1, SU1, W1]-X-FL-[LEDCB, LEDCR]-W-BK-LC-UNV
Lumens	434 Lm
Watts	13.5 W
LPW	32.1 Lm/W
CCT	3500K
SC (0/90/45)	0.77 / 0.77 / 0.76
Beam Angle	48.5°
Module set to 3500K CCT, 100% output	

COLOR METRIC SUMMARY	
TM-30-15	Rf = 90.4 Rg = 98.7
CRI/CIE	Ra = 92.5 R9 = 65.5

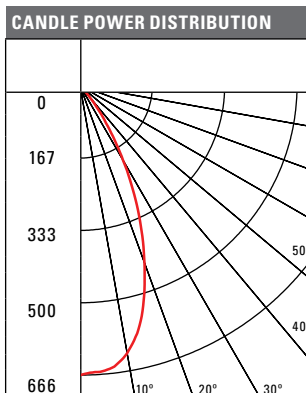
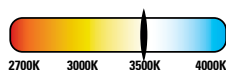

CONE OF LIGHT			
Horizontal Illuminance on Floor			
MH	FC	L	W
2'	166.5	1.4	1.4
4'	41.6	3	3
6'	18.5	4.6	4.6
8'	10.4	6	6
10'	6.7	7.6	7.6
15'	3	11.4	11.4
20'	1.7	15.2	15.2
30'	0.7	23	23
40'	0.4	30.6	30.6

CANDELA TABLE	
Angle	0-deg
0	666
5	658
10	625
15	549
20	434
30	199
40	39
50	3
60	1
70	1
80	0
90	0

		1002-[P1] Regressed Hood - Black L1 - 10W		
		CBCP	Lumens	LPW
S Spot 15°	LED2790	4566	358	35.8
	LED3090	4837	379	37.9
	LED3590	5236	411	41.1
	LED4080	6028	473	47.3
	LED5080	6581	516	51.6
	LED2797	4350	341	34.1
	LED3097	4657	365	36.5
	LED3597	4898	384	38.4
	LED4097	5022	394	39.4
	LED2790	4252	724	72.4
M Medium Flood 25°	LED3090	4505	767	76.7
	LED3590	4877	831	83.1
	LED4080	5614	956	95.6
	LED5080	6129	1044	104.4
	LED2797	4051	690	69.0
	LED3097	4337	739	73.9
	LED3597	4562	777	77.7
	LED4097	4677	797	79.7
	LED2790	1604	746	74.6
	LED3090	1699	791	79.1
F Flood 40°	LED3590	1840	856	85.6
	LED4080	2118	985	98.5
	LED5080	2312	1076	107.6
	LED2797	1528	711	71.1
	LED3097	1636	761	76.1
	LED3597	1721	801	80.1
	LED4097	1764	821	82.1
	LED2790	798	685	68.5
	LED3090	846	726	72.6
	LED3590	916	785	78.5
W Wide Flood 55°	LED4080	1054	904	90.4
	LED5080	1151	987	98.7
	LED2797	761	653	35
	LED3097	814	699	69.9
	LED3597	856	735	73.5
	LED4097	878	753	75.3

TM30 DATA

1002	CCT/CRI	Rf	Rg	Ra	R9
	2790	91.8	100	93.8	66.3
	3090	91.3	99.1	92.1	62.6
	3590	90.4	98.7	92.5	65.5
	4080	82.6	93.8	84.2	15.1
	5080	81.4	93.3	83.8	14
	2797	94.7	100.3	98.2	92.7
	3097	94	100.1	98.6	94.2
	3597	93	99.6	98.2	95.3
	4097	91.1	97.8	95.9	87.7

LUMEN MAINTENANCE

Ambient Temperature	TM-21 Lumen Maintenance (60,000 Hours)	Theoretical L70 (Hours)
25°C, 40°C, 50°C	> 86%	> 90,000

POWER TABLE

Number of Heads	Light Level	Input Current (A) at 120 VAC	Input Current (A) at 277 VAC	Input Power (W)
P1	L1	0.08	0.03	10
	LC1	0.1	0.085	11.4
P2	L1	0.16	0.06	20
	LC1	0.2	0.17	22.8