



**Domus'** timeless design has proven to be one of the most adaptable shapes we offer and with the **Domus 55** you will get even more versatility. Designed with a higher profile than it's counterparts, the **Domus 55** offers flexible mounting options such as the side arm mount.

Project: \_\_\_\_\_

Location: \_\_\_\_\_

Cat.No: \_\_\_\_\_

Type: \_\_\_\_\_

Lamps: \_\_\_\_\_ Qty: \_\_\_\_\_

Notes: \_\_\_\_\_

#### Ordering guide:

**Example: DMS55-C-140L1675NW-G1-3-UNV-DMG-SMD-PH8-RCD-BKTX**

Series	LED module		Generation	Optical system	Ballast	Driver options <sup>3</sup>
<b>DMS55-C</b>			<b>G1</b>			
<b>DMS55-C</b>	<b>4000K</b>	<b>3000K</b>	<b>G1</b>	<b>1</b> Type 1 (ASYM) <b>2</b> Type 2 (ASYM) <b>3</b> Type 3 (ASYM) <b>4</b> Type 4 (ASYM) <b>5</b> Type 5 (SYMM)	<b>UNV</b> 120-277VAC <b>347</b> 347VAC <b>480</b> 480VAC	<b>CDMGE25</b> <sup>1</sup> Economy 8 hrs. 25% reduction <b>CDMGE50</b> <sup>1</sup> Economy 8 hrs. 50% reduction <b>CDMGE75</b> <sup>1</sup> Economy 8 hrs. 75% reduction <b>CDMGM25</b> <sup>1</sup> Median 6 hrs. 25% reduction <b>CDMGM50</b> <sup>1</sup> Median 6 hrs. 50% reduction <b>CDMGM75</b> <sup>1</sup> Median 6 hrs. 75% reduction <b>CDMGS25</b> <sup>1</sup> Safety 4 hrs. 25% reduction <b>CDMGS50</b> <sup>1</sup> Safety 4 hrs. 50% reduction <b>CDMGS75</b> <sup>1</sup> Safety 4 hrs. 75% reduction <b>DMG</b> 0 - 10V <b>DALI</b> <sup>1,4</sup> DALI compatible
	140L450NW <sup>4</sup>	140L450WW <sup>4</sup>				
	140L650NW <sup>4</sup>	140L650WW <sup>4</sup>				
	140L1150NW	140L1150WW				
	140L1675NW	140L1675WW				
	140L2100NW	140L2100WW				

#### Ordering guide (continued)

Adaptors	Luminaire options		Poles & Brackets	Finish
<b>MA1</b> 1 1/4" NPT threaded hole adapter accepting threaded tube.	<b>PH8</b> <sup>4</sup>	Twist-lock Photoelectric Cell	Consult <a href="http://signify.com/outdoorluminaires">signify.com/outdoorluminaires</a> for details and the complete line of Signify poles and brackets.	<b>BE2TX</b> Textured midnight blue
<b>MA2</b> 1 1/2" NPT threaded hole adapter accepting threaded tube	<b>PHXL</b> <sup>1,4</sup>	Twist-lock Photoelectric Cell, extended life, UNV (120-277VAC)		<b>BE6TX</b> Textured ocean blue
<b>SMA</b> Decorative retro side-mounted cast-aluminum, accepts tubes from 1 5/8" to 2 3/8"	<b>PH9</b> <sup>4</sup>	Shorting cap		<b>BE8TX</b> Textured royal blue
<b>SMB</b> Decorative contemporary side-mounted cast-aluminum, accepts tubes from 1 5/8" to 2 3/8"	<b>RCD</b> <sup>2</sup>	Receptacle for twist-lock photocell or shorting cap, 5-pin		<b>BG2TX</b> Textured Sandstone
<b>SMD</b> Side-mounted cast-aluminum, accepts tubes from 1 5/8" to 2 3/8"	<b>RCD7</b> <sup>2</sup>	Receptacle for twist-lock photocell or shorting cap, 7-pin		<b>BKTX</b> Textured black
	<b>SP2</b>	20kV / 10kA Surge Protector (optional)		<b>BRTX</b> Textured bronze
			<b>GN4TX</b> Textured blue green	
			<b>GN6TX</b> Textured forest green	
			<b>GN8TX</b> Textured Dk forest green	
			<b>GNTX</b> Textured green	
			<b>GR</b> Gray sandtex	
			<b>GY3TX</b> Textured medium grey	
			<b>NP</b> Natural aluminum	
			<b>RD2TX</b> Textured burgundy	
			<b>RD4TX</b> Textured scarlet	
			<b>TG</b> Hammertone gold	
			<b>WHTX</b> Textured white	

#### Footnotes

- Not available with 347V and 480V.
- Use of photoelectric cell or shorting cap is required to ensure proper illumination.
- Select either CDMG or DMG or DALI mandatory option.
- RCD or RCD7 must be selected for this option.
- For 240 or 277 volt with DALI or CDMG options consult factory.



# DMS55-C Domus LED Pendant

## Urban Luminaire with comfort optics

### Dimensions

EPA: 1.64 ft<sup>2</sup> max.

Weight: 42.5lbs

EPA and weight are calculated without adaptor.

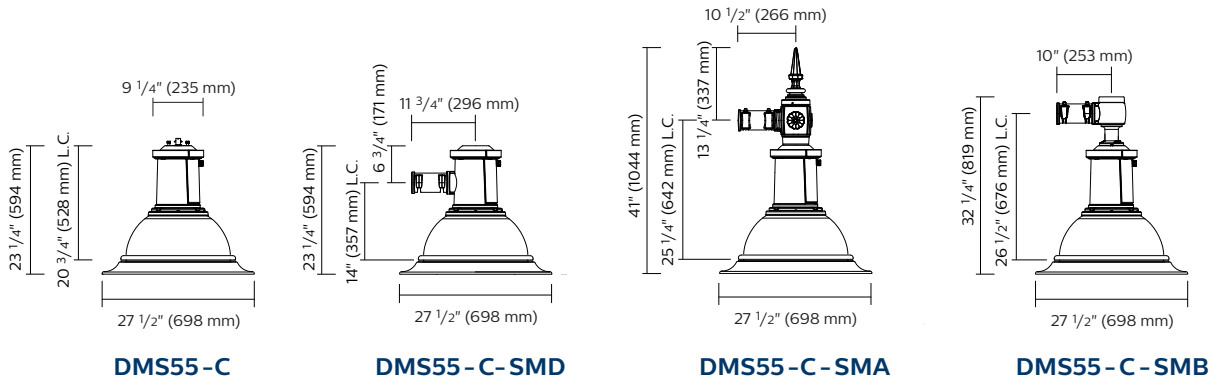

### Predicted Lumen Depreciation Data

Predicted performance derived from LED manufacturer's data and engineering design estimates, based on IESNA LM-80 methodology. Actual experience may vary due to field application conditions. L<sub>70</sub> is the predicted time when LED performance depreciates to 70% of initial lumen output. Calculated per IESNA TM21-11. Published L<sub>70</sub> hours limited to 6 times actual LED test hours.

Ambient Temperature °C	Driver mA	Calculated L <sub>70</sub> Hours	L <sub>70</sub> per TM-21	Lumen Maintenance % at 60,000 hrs
25°C	up to 2100 mA	>100,000 hours	>60,000 hours	>83%

### LED Wattage and Lumen Values: 4000K Domus luminaire

#### 4000K

Ordering Code	Total LEDs	LED Current (mA)	Average System Watts	Color Temp.	Type 1			Type 2		
					Delivered Lumens	Efficacy (LPW)	BUG Rating	Delivered Lumens	Efficacy (LPW)	BUG Rating
140L450NW-G1	140	450	21	4000K	2230	106	B1-U0-G1	2226	106	B1-U0-G1
140L650NW-G1	140	650	30	4000K	3120	104	B2-U0-G2	2906	97	B1-U0-G1
140L1150NW-G1	140	1150	52	4000K	5309	102	B2-U0-G2	4946	95	B2-U0-G2
140L1675NW-G1	140	1675	75	4000K	7292	97	B3-U0-G3	6792	91	B3-U0-G3
140L2100NW-G1	140	2100	94	4000K	8847	94	B3-U0-G3	8242	88	B3-U0-G3

#### 4000K (Continued)

Ordering Code	Total LEDs	LED Current (mA)	Average System Watts	Color Temp.	Type 3			Type 4			Type 5		
					Delivered Lumens	Efficacy (LPW)	BUG Rating	Delivered Lumens	Efficacy (LPW)	BUG Rating	Delivered Lumens	Efficacy (LPW)	BUG Rating
140L450NW-G1	140	450	21	4000K	2285	109	B1-U0-G1	2467	117	B1-U0-G1	2243	107	B1-U0-G1
140L650NW-G1	140	650	30	4000K	2983	99	B1-U0-G1	3221	107	B1-U0-G1	3138	105	B2-U0-G1
140L1150NW-G1	140	1150	52	4000K	5077	98	B2-U0-G2	5481	105	B2-U0-G2	5340	103	B3-U0-G2
140L1675NW-G1	140	1675	75	4000K	6972	93	B2-U0-G2	7528	100	B2-U0-G2	7334	98	B3-U0-G2
140L2100NW-G1	140	2100	94	4000K	8460	90	B3-U0-G3	9134	97	B3-U0-G3	8899	95	B3-U0-G2

# DMS55-C Domus LED Pendant

## Urban Luminaire with comfort optics

### LED Wattage and Lumen Values: 3000K Domus luminaire

**3000K**

Ordering Code	Total LEDs	LED Current (mA)	Average System Watts	Color Temp.	Type 1			Type 2		
					Delivered Lumens	Efficacy (LPW)	BUG Rating	Delivered Lumens	Efficacy (LPW)	BUG Rating
140L450NW-G1	140	450	21	3000K	2230	106	B1-U0-G1	2226	106	B1-U0-G1
140L650NW-G1	140	650	30	3000K	3120	104	B2-U0-G2	2906	97	B1-U0-G1
140L1150NW-G1	140	1150	52	3000K	5309	102	B2-U0-G2	4946	95	B2-U0-G2
140L1675NW-G1	140	1675	75	3000K	7292	97	B3-U0-G3	6792	91	B3-U0-G3
140L2100NW-G1	140	2100	96	3000K	8847	94	B3-U0-G3	8242	88	B3-U0-G3

**3000K (continued)**

Ordering Code	Total LEDs	LED Current (mA)	Average System Watts	Color Temp.	Type 3			Type 4			Type 5		
					Delivered Lumens	Efficacy (LPW)	BUG Rating	Delivered Lumens	Efficacy (LPW)	BUG Rating	Delivered Lumens	Efficacy (LPW)	BUG Rating
140L450WW-G1	140	450	21	3000K	2285	109	B1-U0-G1	2467	117	B1-U0-G1	2243	107	B1-U0-G1
140L650WW-G1	140	650	30	3000K	2983	99	B1-U0-G1	3221	107	B1-U0-G1	3138	105	B2-U0-G1
140L1150WW-G1	140	1150	52	3000K	5077	98	B2-U0-G2	5481	105	B2-U0-G2	5340	103	B3-U0-G2
140L1675WW-G1	140	1675	75	3000K	6972	93	B2-U0-G2	7528	100	B2-U0-G2	7334	98	B3-U0-G2
140L2100WW-G1	140	2100	94	3000K	8460	90	B3-U0-G3	9134	97	B3-U0-G3	8899	95	B3-U0-G2

Actual performance may vary due to installation variables including optics, mounting/ceiling height, dirt depreciation, light loss factor, etc.; highly recommended to confirm performance with a layout - contact Applications at [outdoorlighting.applications@signify.com](mailto:outdoorlighting.applications@signify.com).

Note: Some data may be scaled based on tests of similar but not identical luminaires.

# DMS55-C Domus LED Pendant

## Urban Luminaire with comfort optics

### Specifications:

#### Housing

In a round shape, this housing is made of die cast A380 aluminum, c/w a watertight grommet, mechanically assembled to the bracket with four bolts 5/16 18 UNC. This suspension system permits for a full rotation of the luminaire in 90° increments.

#### Access-mechanism

A die cast A360 aluminum technical ring with latch, hinge and a cast in decorative skirt. The mechanism shall offer tool free access to the inside of the luminaire. An embedded memory retentive gasket shall ensure weatherproofing.

#### Light engine

Light guide technology provides low-glare, uniform illumination. Composed of 140 LEDs strategically positioned on the edge of the optical plate. Light engine luminous opening size optimized to best achieve a balance between lumen output and optical performance with the need to provide visual comfort. Light engine frame ensures contact with housing to provide heat conduction and sealing against the elements. Light engine is RoHS compliant. Maximum ambient operating temperature up to 40°C(104°F). Standard color temperatures: 3000K +/- 130K, 4000K +/- 130K, Minimum CRI of 70. Also available in 2700K, 3500K, 5000K and Amber (>590nm) with extended lead times. Contact factory for details.

#### Optical System

The advanced LED comfort optical system provides Types 1, 2, 3, 4 and 5. Composed of high performance UV-stabilized optical grade lens with molded micro-optics to achieve desired distribution optimized to get an exceptional lighting uniformity. Performance tested per LM-79 and TM-15 (IESNA) certifying its photometric performance. Street side indicated luminaire designed with 0% uplight (UO per IESNA TM-15).

#### Driver

High power factor of 95%. Electronic driver, operating range 50/60 Hz. Auto adjusting universal voltage input from 120 to 277 and 347 to 480 VAC rated for both application line to line or line to neutral, Class 2, THD of 20% max. Maximum ambient operating temperature from 40°F (40°C) to 130°F (50°C). Certified in compliance to UL1310 cULus requirement. Dry and damp location. Assembled on a unitized removable tray with Tyco quick disconnect plug resisting to 221°F (105°C). Dimmable driver 0-10V. The current supplying the LEDs will be reduced by the driver if the driver experiences internal overheating as a protection to the LEDs and the electrical components. Output is protected from short circuits, voltage overload and current overload. Automatic recovery after correction. Standard built in driver surge protection of 2.5kV (min) with DALI or CDMG, driver is class 1..

#### Surge Protection

Surge protector tested in accordance with ANSI/IEEE C62.45 per ANSI/IEEE C62.41.2 Scenario I Category C High Exposure 10kV/10kA waveforms for Line Ground, Line Neutral and Neutral Ground, and in accordance with U.S. DOE (Department of Energy) MSSLC (Municipal Solid State Street Lighting Consortium) model specification for LED roadway luminaires electrical immunity requirements for High Test Level 10kV / 10kA. **SP2** 20kV/10kA optional.

#### Driver options

**DALI:** Pre-set driver compatible with the DALI control system.

**DMG:** Dimmable driver 0-10V.

**CDMG:** Dynadimmer standard dimming functionalities including pre-programmed scenarios to suit many applications and needs from safety to maximum energy savings.

Ordering Code	Scenario	Dimming Time	Dimming Level
CDMG525	Safety	4 hours	25% power dimming
CDMG550	Safety	4 hours	50% power dimming
CDMG575	Safety	4 hours	75% power dimming
CDMG25	Median	6 hours	25% power dimming
CDMG50	Median	6 hours	50% power dimming
CDMG75	Median	6 hours	75% power dimming
CDMG25	Economy	8 hours	25% power dimming
CDMG50	Economy	8 hours	50% power dimming
CDMG75	Economy	8 hours	75% power dimming

#### Luminaire adaptor

**MA1:** The luminaire is suspended by means of a mounting adaptor with a 1/4" (32mm) NPT threaded hole accepting a threaded tube from the mounting. Retrofit adaptor for existing mounting

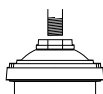

**MA2:** 1/2" (38mm) NPT threaded hole accepting threaded tube from the mounting. Retrofit adaptor for existing mounting.

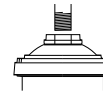

**SMA:** The luminaire is suspended by means of a decorative side-mounted cast aluminum adaptor. This adaptor accepts tubes from 1<sup>5/8</sup>" to 2<sup>3/8</sup>" (41 to 60 mm) and is adjustable to more or less 5°. The adaptor features a cast aluminum decorative cover and finial.

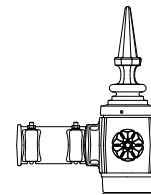

**SMB:** The luminaire is suspended by means of a decorative side-mounted cast aluminum adaptor. This adaptor accepts tubes from 1<sup>5/8</sup>" to 2<sup>3/8</sup>" (41 to 60 mm) and is adjustable to more or less 5°.

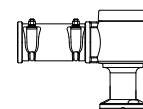

**SMD:** The luminaire is suspended by means of a decorative side-mounted cast aluminum adaptor. This adaptor accepts tubes from 1<sup>5/8</sup>" to 2<sup>3/8</sup>" (41 to 60 mm) and is adjustable to more or less 5°.

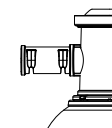

# DMS55-C Domus LED Pendant

## Urban Luminaire with comfort optics

### Specifications (continued):

#### Luminaire options

**BO:** Bridge and Overpass

**PH8:** Photoelectric Cell, Twist-lock Type. Allows a 90 degree rotation.

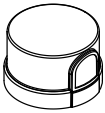

**PHXL:** Extended life photoelectric cell, Twist-lock Type. Allows a 90 degree rotation.

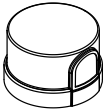

**PH9:** Shorting cap, Twist-lock Type

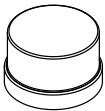

**RCD:** Receptacle 5 pins



**RCD7:** Receptacle 7 pins



**SP2:** Integral surge protector

#### Finish

In accordance with the AAMA 2603 standard. Application of polyester powder coat paint (4 mils/100 microns) with +/- 1 mils/24 microns of tolerance. The Thermosetting resins provides a discoloration resistant finish in accordance with the ASTM D2244 standard, as well as luster retention in keeping with the ASTM D523 standard and humidity proof in accordance with the ASTM D2247 standard. The surface treatment achieves a minimum of 2000 hours for salt spray resistant finish in accordance with testing performed and per ASTM B117 standard.

#### Finish Options Include:

**BE2TX:** Textured Midnight Blue

**BE6TX:** Textured Ocean Blue

**BE8TX:** Textured Royal Blue

**BG2TX:** Textured Sandstone

**BKTX:** Textured Black

**BRTX:** Textured Bronze

**GN4TX:** Textured Blue Green

**GN6TX:** Textured Forest Green

**GN8TX:** Textured Dark Forest Green

**GNTX:** Textured Green

**GR:** Gray Sandtex

**GY3TX:** Textured Medium Grey

**NP:** Natural Aluminum

**RD2TX:** Textured Burgundy

**RD4TX:** Textured Scarlet

**TG:** Hammer-tone Gold

**WHTX:** Textured White

#### Wiring

Gauge (#14) TEW/AWM 1015 or 1230 wires, 6" (152mm) minimum exceeding from luminaire.

#### Hardware

All exposed screws shall be complete with Ceramic primer-seal base coat to reduce seizing of the parts and offers a high resistance to corrosion. All seals and sealing devices are made and/or lined with EPDM and/or silicone and/or rubber.

#### LED products (manufacturing standard)

The electronic components sensitive to electrostatic discharge (ESD) such as light emitting diodes (LEDs) are assembled in compliance

with IEC61340 5 1 and ANSI/ESD S20.20 standards so as to eliminate ESD events that could decrease the useful life of the product.

#### Quality control

Manufactured to ISO 9001 2008 standards and ISO 14001-2004 International Quality Standards Certification.

#### Vibration resistance

Meets the ANSI C136.31, 2010 American National Standard for Roadway Luminaire Vibration specifications for Bridge/overpass applications. (Tested for 3G over 100 000 cycles)

#### Certifications and Compliance

CSA, cULus Listed for Canada and USA. Domus LED luminaires are DesignLights Consortium qualified.

# DMS55-C Domus LED Pendant

Urban Luminaire with comfort optics

## Specifications (continued):

### Poles & Brackets Sample configurations.

