

Project		Catalog #		Type	
Prepared by		Notes		Date	



Lumark

Axcent

Wall Mount Luminaire

Product Features



Product Certifications



Interactive Menu

- Ordering Information [page 2](#)
- Mounting Details [page 3](#)
- Product Specifications [page 4](#)
- Energy and Performance Data [page 4](#)
- Control Options [page 6](#)

Quick Facts

- Available in 14W - 123W (1,800 - 17,000 lumens) models
- Full cutoff and refractive lens models available
- Energy and maintenance savings up to 95% compared to HID
- Energy efficient illumination results in up to 144 LPW
- Replaces 70W up to 450W HID equivalents

Connected Systems

- WaveLinX Lite
- Enlighted

Dimensional Details

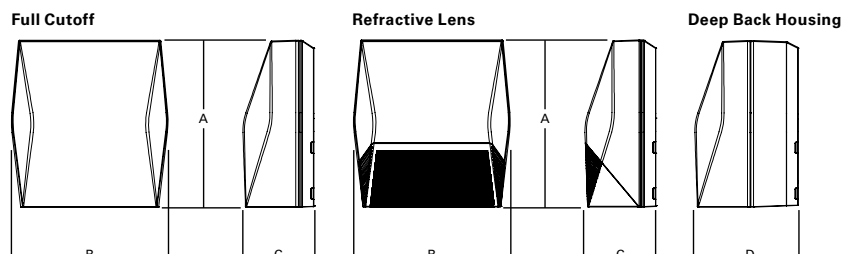

Dimensional Data

	AXCS Small	AXCL Large
A	8" [202mm]	11-1/2" [292mm]
B	7-1/2" [190mm]	10-3/4" [273mm]
C	3-5/8" [94mm]	4-7/8" [124mm]
D	6-1/8" [155mm]	7-1/8" [181mm]

Ordering Information

SAMPLE NUMBER: AXCS1A-AP-347V

Domestic Preferences ²⁸	Model Series ¹	LED Color Temperature	Color	Options (Add as Suffix)
[Blank] =Standard BAA =Buy American Act TAA =Trade Agreements Act	Full Cutoff AXCS1A=14W AXCS2A=21W AXCS3A=27W AXCS4A=44W AXCS5A=52W AXCL6A=56W AXCL8A=72W AXCL10A=102W AXCL12A=123W Refractive Lens AXCS1ARL=14W AXCS2ARL=21W AXCS3ARL=27W AXCS4ARL=44W AXCS5ARL=52W AXCL6ARL=56W AXCL8ARL=72W AXCL10ARL=102W AXCL12ARL=123W	[Blank] =4000K, Neutral C=5000K, Cool W=3000K, Warm	[Blank] =Carbon Bronze (Standard) WT=Summit White BK=Black AP=Grey GM=Graphite Metallic DP=Dark Platinum	347V=347V ² 480V=480V ² PC1=Photocontrol 120V ^{3,4,5} PC2=Photocontrol 208-277V, 347V, 480V ^{4,5,6} PC=Photocontrol 120-277V, 347V, 480V ^{4,7,8} KKIT=Knuckle Floodlight Mount ⁷ TRNKIT=Trunnion Floodlight Mount SFKIT=Slipfitter Floodlight Mount PMAKIT=Pole Mount Arm ZW=WaveLinx-enabled 4-PIN Twistlock Receptacle ^{4,9} ZW-SWPD4XX=WaveLinx Wireless Sensor, 7' - 15' Mounting Height ^{4,9,10,11} ZW-SWPD5XX=WaveLinx Wireless Sensor, 15' - 40' Mounting Height ^{4,9,10,11} LWR-LW=Enlighted Wireless Sensor, Wide Lens for 8' - 16' Mounting Height ^{4,9,12} LWR-LN=Enlighted Wireless Sensor, Narrow Lens for 16' - 40' Mounting Height ^{4,9,12} MSP/DIM-L12=Integrated Sensor for Dimming Operation, 8' - 12' Mounting Height ^{4,9,13} MSP/DIM-L30=Integrated Sensor for Dimming Operation, 12' - 30' Mounting Height ^{4,9,13} MSP-L12=Integrated Sensor for ON/OFF Operation, 8' - 12' Mounting Height ^{4,9,13} MSP-L30=Integrated Sensor for ON/OFF Operation, 12' - 30' Mounting Height ^{4,9,13} CBP=Cold Weather Battery Pack ^{3,14,15,16,17,18} CBP-CEC=Cold Weather Battery Pack, CEC compliant ^{3,14,15,16,17,18} 10K=10kV/10kA Surge Protection HA=50°C High Ambient ^{15,19} GRF=Glare Reducing Lens ²⁰ AHD145=After Hours Dim, 5 Hours ^{5,21} AHD245=After Hours Dim, 6 Hours ^{5,21} AHD255=After Hours Dim, 7 Hours ^{5,21} AHD355=After Hours Dim, 8 Hours ^{5,21}
Accessories (Order Separately) ^{22,29}				
VS/AXCS-XX=Vandal Shield Axcent Small ^{7,23} VS/AXCS-MS=Vandal Shield Axcent Small (With Motion Sensor) ^{7,23} WG/AXCS=Wire Guard Axcent Small ⁷ WG/AXCS-MS=Wire Guard Axcent Small (With Motion Sensor) ⁷ VS/AXCL-XX=Vandal Shield Axcent Large ^{5,23} VS/AXCL-MS=Vandal Shield Axcent (With Motion Sensor) ^{5,23} WG/AXCL=Wire Guard Axcent Large ⁵ WG/AXCL-MS=Wire Guard Axcent (With Motion Sensor) ⁵ BB/AXC=Axcent Lumen Select Back Box, Carbon Bronze ²⁴ BB/AXC-PC=Axcent Lumen Select Back Box with PC, Carbon Bronze ^{24,25} BB/AXC-WT=Axcent Lumen Select Back Box, Summit White ²⁴ BB/AXC-WT-PC=Axcent Lumen Select Back Box with PC, Summit White ^{24,25}		KKIT/AXCS-XX=Knuckle and Visor Floodlight Kit (For Axcent Small) ⁷ SFKIT/AXCS-XX=Slipfitter Floodlight Kit (For Axcent Small) ⁷ TRNKIT/AXCS-XX=Trunnion and Visor Floodlight Kit (For Axcent Small) ⁷ TRNKIT-XX=Trunnion Floodlight Kit (For Axcent Large) ⁵ SFKIT-XX=Slipfitter Floodlight Kit (For Axcent Large) ⁵ PMAKIT-XX=Pole Mount Kit ISHH-01=Integrated Sensor Programming Remote ²⁶ MA1010-XX=Single Tenon Adapter for 3-1/2" O.D. Tenon MA1011-XX=2@180° Tenon Adapter for 3-1/2" O.D. Tenon MA1017-XX=Single Tenon Adapter for 2-3/8" O.D. Tenon MA1018-XX=2@180° Tenon Adapter for 2-3/8" O.D. Tenon SWPD4-XX=WaveLinx Wireless Sensor, 7' - 15' Mounting Height ^{10,11,27} SWPD5-XX=WaveLinx Wireless Sensor, 15' - 40' Mounting Height ^{10,11,27}		
NOTES: 1. DesignLights Consortium® Qualified. Refer to www.designlights.org Qualified Products List under Family Models for details. 2. Transformer used only when ordered with motion sensor or AXCS1 through AXCS5 or AXCL6 fixture wattages. 3. Not available in 347 or 480 VAC. 4. Button photocontrol and any motion sensor (MSP, ZW, or LWR) not offered together. 5. Only available on AXCL6-AXCL12 models. 6. Used with 277, 347, and 480 VAC options. 7. Only available on AXCS1-AXCS5 models. 8. This configuration may contain materials that are not RoHS compliant. Contact your lighting representative for more information. 9. Uses deep back housing. 10. Sensor passive infrared (PIR) may be overly sensitive when operating below -20°C (-4°F). For the device to be field-configurable, requires WAC Gateway components WAC-PoE and WPOE-120 in appropriate quantities. Only compatible with WaveLinx system and software and requires system components to be installed for operation. See website for more WaveLinx application information. 11. Replace XX with sensor color (WH, BZ, or BK). 12. Enlighted wireless sensors are factory installed and require network components LWP-EM-1, LWP-GW-1, and LWP-PoE8 in appropriate quantities. See website for application information. 13. The ISHH-01 accessory is required to adjust parameters. 14. Ambient operating temperature -20°C to 25°C for AXCL6 through AXCL10. Ambient operating temperature -20°C to 30°C on AXCS4 models. Ambient operating temperature -20°C to 40°C on AXCS1 through AXCS3 models. 15. Not available with AXCS5 or AXCL12 models. 16. Uses deep back housing for AXCS1, AXCL2, AXCS3, and AXCS4 models. 17. Not to be mounted in upwards / inverted orientation. Downlight wall mount only for AXCS1 through AXCS4. 18. CBP cannot be used with PC and motion sensor (MSP, ZW, or LWR). CBP can be used with PC or motion sensor (MSP, ZW, or LWR). 19. Can not be ordered with CBP or PC options. 20. Use dedicated IES files on product website for lumen values and distributions. 21. Requires the use of PC1 or PC2 button photocontrol. See After Hours Dim supplemental guide for additional information. 22. Replace XX with color designation. 23. For use with full cutoff lens configurations only. 24. Lumen Select functionality not available in conjunction with any motion sensor option (MSP, ZW, or LWR). Photocontrol back box not available with any photocontrol or motion sensor options (PC, MSP, ZW, or LWR). 25. Photocell only operates at 120-277V input voltages. Not for use with 347 or 480V systems. 26. This tool enables adjustment to parameters including high and low modes, sensitivity, time delay, cutoff and more. Consult your lighting representative for more information. 27. Requires 4-PIN twistlock receptacle (ZW) option. 28. Only product configurations with these designated prefixes are built to be compliant with the Buy American Act of 1933 (BAA) or Trade Agreements Act of 1979 (TAA), respectively. Please refer to DOMESTIC PREFERENCES website for more information. Components shipped separately may be separately analyzed under domestic preference requirements. 29. Accessories sold separately will be separately analyzed under domestic preference requirements. Consult factory for further information.				

Stock Ordering Information

Model Series ¹			
Full Cutoff		Refractive Lens	
AXCS1A=14W	AXCL10A=102W	AXCS1ARL=14W	AXCL10ARL=102W
AXCS2A=21W	AXCL12A=123W	AXCS2ARL=21W	AXCL12ARL=123W
AXCS3A=27W	AXCL6A-347V=56W	AXCS3ARL=27W	AXCL6ARL-347V=56W
AXCS4A=44W	AXCL8A-347V=72W	AXCS4ARL=44W	AXCL8ARL-347V=72W
AXCS5A=52W	AXCL10A-347V=102W	AXCS5ARL=52W	AXCL10ARL-347V=102W
AXCL6A=56W	AXCL12A-347V=123W	AXCL6ARL=56W	AXCL12ARL-347V=123W
AXCL8A=72W		AXCL8ARL=72W	

Note: All stock configurations are 4000K color temperatures, standard Carbon Bronze finish, and wall mount configuration.

Mounting Details

Slipfitter Mount (Small)
Tenon OD: 2-3/8" | EPA: 0.60

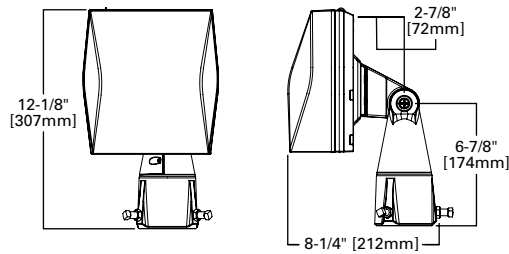

Knuckle Mount (Small)

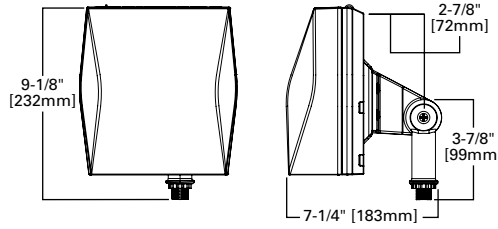

Trunnion Mount Detail

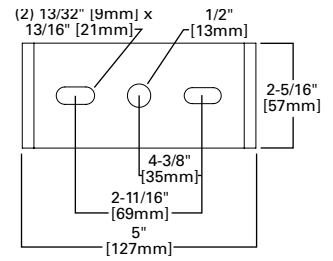

Trunnion Mount (Small)

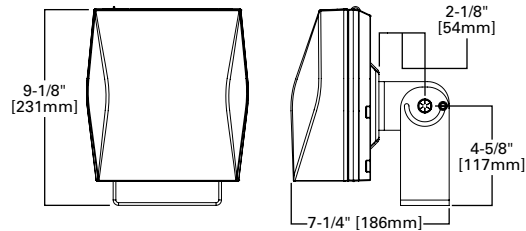

Slipfitter Mount (Large)
Tenon OD: 2-3/8" to 2-7/8" | EPA: 1.10

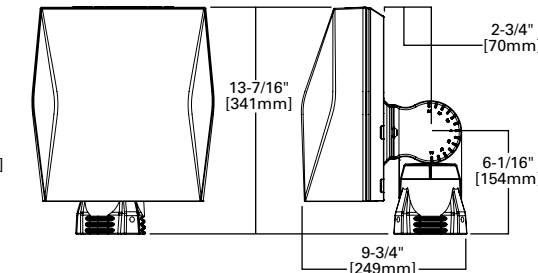

Pole Mount Arm Drill Pattern

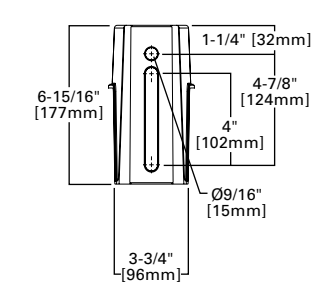

Trunnion Mount (Large)

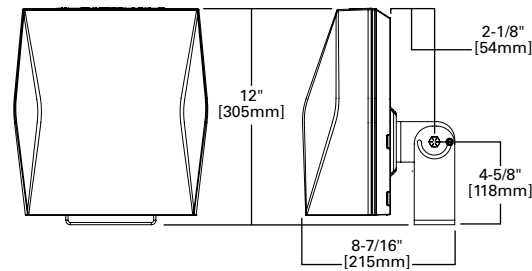

Pole Mount Arm (Large)
EPA: 1.10

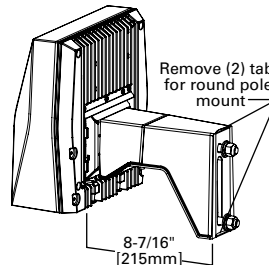

Lumen Select Back Box

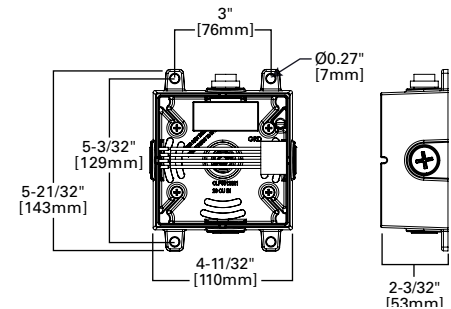

Wall Mount Plate Detail (Large)

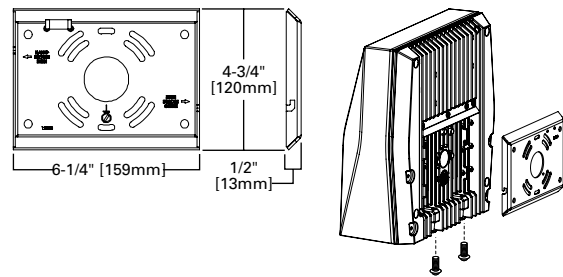

Wall Mount Plate Detail (Small)

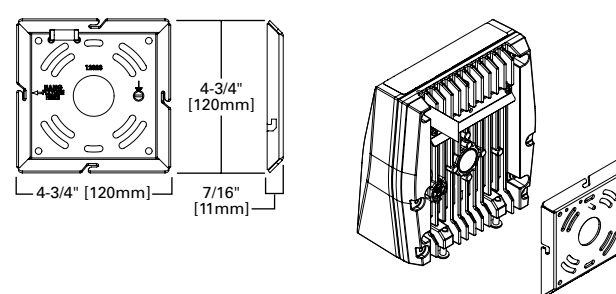

Enlighted Sensor

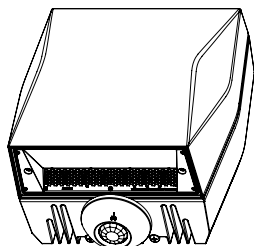

Occupancy Sensor

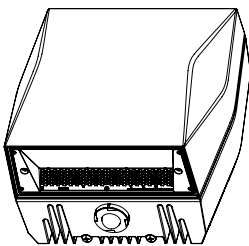

Button Photocontrol

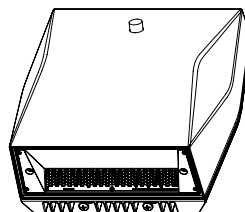

Vandal Shield

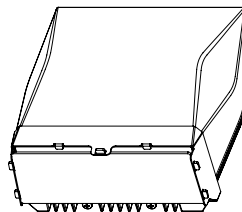

Wire Guard

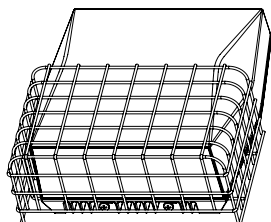

Product Specifications

Construction

- Die-cast aluminum housing
- External back fin design extracts heat from the surface to thermally optimize design for longer luminaire life

Optics

- Dark Sky Approved (Fixed mount, Full cutoff, and 3000K CCT only)
- Silicone-sealed optical LED chamber
- Acrylic refractive or full cutoff lens options for Type IV distributions

Electrical

- Standard universal voltage (120-277V, 50/60Hz)
- Driver incorporates 6kV surge protection
- -40°C minimum operating temperature
- 40°C maximum operating temperature
- <20% total harmonic distortion

- 0-10V dimming driver is standard with leads external to the fixture

Mounting

- Steel wedge mounting plate fits directly to 4" standard j-box or directly to wall with the "Hook-N-Lock" mechanism
- Stainless steel set screws
- Lumen Select Back Box accessory offers four 1/2" NPT conduit entry wire ways. Resistor Pack combinations allow field-dimming of 75% or 50% when connected to luminaire dimming leads
- Not suitable for indoor use when installed in inverted/uplight orientation

Emergency Egress

- Optional integral cold weather battery emergency egress includes emergency operation test switch, an AC-ON indicator light and a premium, maintenance-free battery pack

- The separate emergency lighting LEDs are wired to provide redundant emergency lighting. Listed to UL Standard 924, Emergency Lighting

Finish

- Five-stage super TGIC polyester powder coat paint, 2.5 mil nominal thickness

Shipping Data

- Small fixture=5 lbs. [2.36 kgs.]
- Small with sensor or CBP=10 lbs. [4.40 kgs.]
- Large fixture=12 lbs. [5.45 kgs.]
- Large with sensor or CBP=17 lbs. [7.73 kgs.]
- Large with sensor & CBP=21 lbs. [9.54 kgs.]

Energy and Performance Data

Power and Lumens (Axcent Small)

Light Engine		AXCS1A	AXCS2A	AXCS3A	AXCS4A	AXCS5A
Power (Watts)		14	21	27	44	52
Input Current @ 120V (A)		0.12	0.18	0.23	0.37	0.43
Input Current @ 240V (A)		0.06	0.09	0.11	0.18	0.22
Input Current @ 277V (A)		0.05	0.08	0.10	0.16	0.19
Input Current @ 347V (A)		0.04	0.06	0.08	0.13	0.15
Input Current @ 480V (A)		0.03	0.04	0.06	0.09	0.11
Configuration						
Full Cutoff	4000K/5000K Lumens	1,806	2,561	3,537	5,520	6,300
	3000K Lumens	1,526	2,164	2,989	4,665	5,324
	BUG Rating	B1-U0-G0	B1-U0-G0	B1-U0-G0	B2-U0-G1	B2-U0-G1
Refractive Lens	4000K/5000K Lumens	1,915	2,716	3,704	5,858	6,699
	3000K Lumens	1,618	2,295	3,130	4,950	5,661
	BUG Rating	B1-U3-G2	B1-U3-G2	B1-U3-G2	B1-U4-G3	B1-U4-G3

Power and Lumens (Axcent Large)

Light Engine		AXCL6A	AXCL8A	AXCL10A	AXCL12A
Power (Watts)		49.4	65.3	89.1	115.3
Input Current @ 120V (A)		0.41	0.54	0.74	0.96
Input Current @ 240V (A)		0.21	0.27	0.37	0.48
Input Current @ 277V (A)		0.18	0.24	0.32	0.42
Input Current @ 347V (A)		0.14	0.19	0.26	0.33
Input Current @ 480V (A)		0.10	0.14	0.19	0.24
Configuration					
Full Cutoff	4000K Lumens	7,594	9,716	12,719	16,302
	5000K Rating	7,501	9,598	12,564	16,103
	3000K Lumens	6,502	8,319	10,890	13,958
	BUG Rating	B2-U0-G1	B2-U0-G2	B3-U0-G2	B3-U0-G2
Refractive Lens	4000K Lumens	7,809	10,331	13,665	16,637
	5000K Rating	7,714	10,205	13,498	16,434
	3000K Lumens	6,686	8,845	11,700	14,244
	BUG Rating	B1-U4-G4	B2-U5-G5	B2-U5-G5	B2-U5-G5

Energy and Performance Data

Power and Lumens (Small + CBP)

Light Engine		AXCS1A	AXCS2A	AXCS3A	AXCS4A
Power (Watts)		18	25	31	48
Input Current @ 120V (A)		0.15	0.21	0.26	0.40
Input Current @ 240V (A)		0.08	0.11	0.13	0.20
Input Current @ 277V (A)		0.07	0.09	0.11	0.18
Configuration					
Full Cutoff	4000K/5000K Lumens	629	587	647	570
	3000K Lumens	531	496	547	482
Refractive Lens	4000K/5000K Lumens	667	623	686	605
	3000K Lumens	563	526	580	511

Note: Power and current based on full power consumption while CBP is charging. Lumen outputs are while operating in emergency mode only.

Power and Lumens (Large + CBP)

Light Engine		AXCL6A	AXCL8A	AXCL10A
Power (Watts)		60	76	106
Input Current @ 120V (A)		0.50	0.63	0.88
Input Current @ 240V (A)		0.25	0.32	0.44
Input Current @ 277V (A)		0.22	0.27	0.38
Configuration				
Full Cutoff	4000K/5000K Lumens	1,070		
	3000K Lumens	945		
Refractive Lens	4000K/5000K Lumens	1,098		
	3000K Lumens	973		

Note: Power and current based on full power consumption while CBP is charging. Lumen outputs are while operating in emergency mode only.

Power and Lumens Multipliers
(Lumen Select Back Box + Axcent Small)

Configuration		~75% Nominal Output	~50% Nominal Output
Catalog Number	Material Number	Connect per Installation Instructions	
AXCS1A*	13109741 or 13109939 or Other	74%	50%
AXCS2A*	13109698 or 13109938 or Other	74%	50%
AXCS3A*	13109697 or 13109937 or Other	74%	50%
AXCS4A*	13109695 or 13109936	75%	40%
AXCS4A*	13495299 or 13495470 or Other	72%	50%
AXCS5A*	13109652 or 13109935	75%	40%
AXCS5A*	13495471 or 13495472 or Other	72%	50%

Power and Lumens Multipliers
(Lumen Select Back Box + Axcent Large)

Configuration		~75% Nominal Output	~50% Nominal Output
Catalog Number	Material Number	Connect per Installation Instructions	
AXCL6A*	12963843 or 12964235	75%	40%
AXCL6A*	13495473 or 13495474 or Other	69%	47%
AXCL8A*	12963842 or 12964234	84%	48%
AXCL8A*	13495475 or 13495476 or Other	69%	47%
AXCL10A*	12963840 or 12964233	84%	48%
AXCL10A*	13495477 or 13495478 or Other	69%	47%
AXCL12A*	12902056 or 12902057	85%	50%
AXCL12A*	13495479 or 13495480 or Other	72%	49%

Lumen Maintenance (Axcent Small)

Ambient Temperature	TM-21 Lumen Maintenance (72,000 Hours)	Theoretical L70 (72,000 Hours)
Up to 3A		
25°C	90%	246,000
40°C	90%	225,000
50°C	89%	195,000
Up to 5A		
25°C	89%	240,000
40°C	88%	223,000
50°C	87%	186,000

Lumen Maintenance (Axcent Large)

Ambient Temperature	TM-21 Lumen Maintenance (72,000 Hours)	Theoretical L70 (72,000 Hours)
Up to 8A		
25°C	94%	556,000
40°C	94%	556,000
50°C	92%	340,000
Up to 10A		
25°C	94%	556,000
40°C	94%	478,000
50°C	87%	207,000
Up to 12A		
25°C	94%	151,000
40°C	81%	125,000

Lumen Multiplier

Ambient Temperature	Lumen Multiplier
10°C	1.02
15°C	1.01
25°C	1.00
40°C	0.97

Control Options

0-10V This fixture is offered standard with 0-10V dimming driver(s) for use with a lighting control panel or other control method.

Photocontrol (PC1, PC2 and PC) Optional button-type photocontrol provides a flexible solution to enable “dusk-to-dawn” lighting by sensing light levels.

After Hours Dim (AHD) This feature allows photocontrol-enabled luminaires to achieve additional energy savings by dimming during scheduled portions of the night. The dimming profile will automatically take effect after a “dusk-to-dawn” period has been calculated from the photocontrol input. Specify the desired dimming profile for a simple, factory-shipped dimming solution requiring no external control wiring. Reference the After Hours Dim supplemental guide for additional information.

Dimming Occupancy Sensor (MSP/DIM-LXX and MSP-LXX) These sensors are factory installed in the luminaire housing. When the MSP/DIM-LXX sensor option is selected, the occupancy sensor is connected to a dimming driver and the entire luminaire dims when there is no activity detected. When activity is detected, the luminaire returns to full light output. The MSP/DIM sensor is factory preset to dim down to approximately 50 percent power with a time delay of ten minutes. The MSP-LXX sensor is factory preset to turn the luminaire off after five minutes of no activity.

These occupancy sensors includes an integrated photocell that can be activated with the ISHH-01 accessory for “dusk-to-dawn” control or daylight harvesting - the factory preset is ON. The ISHH-01 is a wireless tool utilized for changing the dimming level, time delay, sensitivity and other parameters.

A variety of sensor lens are available to optimize the coverage pattern for mounting heights from 8'-30'.

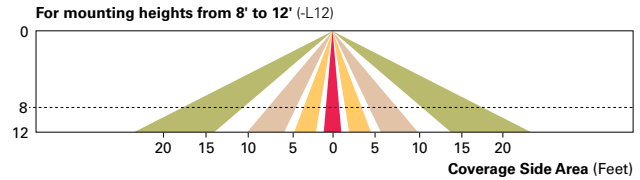
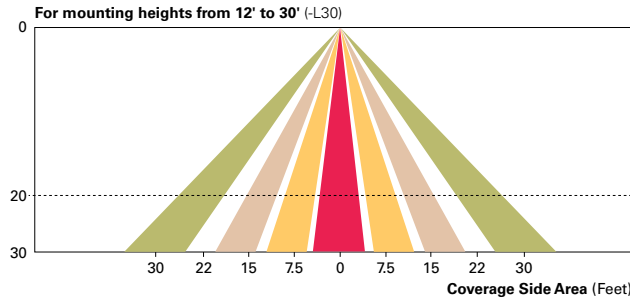

WaveLinX Wireless Control and Monitoring System The WaveLinX Outdoor control platform operates on a wireless mesh network based on IEEE 802.15.4 standards enabling wireless control of outdoor lighting. Use the WaveLinX Mobile application for set-up and configuration. At least one Wireless Area Controller (WAC) is required for full functionality and remote communication (including adjustment of any factory pre-sets).

WaveLinX Wireless Sensor (SWPD4 and SWPD5) These outdoor sensors offer passive infrared (PIR) occupancy and a photocell for closed loop daylight sensing. These sensors can be factory installed or field-installed via simple, tool-less integration into luminaires equipped with the Zhaga Book 18 compliant 4-PIN receptacle (ZW). These sensors are factory preset to dim down to approximately 50 percent power after 15 minutes of no activity detected. These occupancy sensors include an integral photocell for “dusk-to-dawn” control or daylight harvesting that is factory-enabled. A variety of sensor lenses are available to optimize the coverage pattern for mounting heights from 7'-40'.

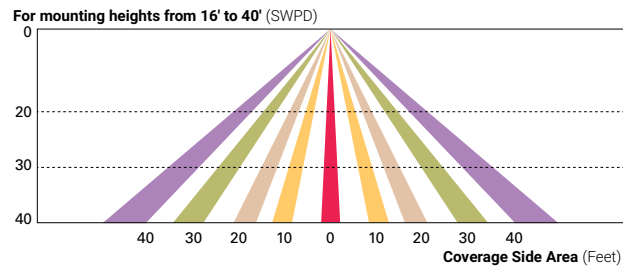

Enlighted Wireless Control and Monitoring System (LWR-LW and LWR-LN) The Enlighted System is a connected lighting solution that combines LED luminaires with an integrated wireless sensor system. The sensor controls the lighting system in compliance with the latest energy codes and collects valuable data about building performance and use. Software applications turn the granular data into information through energy dashboards and specialized apps that make it simple and help optimize the use of other resources beyond lighting.

