



LSI POLES

Built For Your Application



AMERICAN MADE

Experience complete versatility,
fast availability, and unmatched
durability



COMPLETE VERSATILITY

Endless Options, Made to Order

Completely configurable: choose from a wide variety of materials, finishes, sizes and styles to best suit your application and budget.

- Steel, Aluminum or Fiberglass
- Pole heights up to 39'
- Round, Square, Straight, Tapered, Hinged or Decorative

FAST AVAILABILITY

*Industry-Leading
Lead Times*

LSI Poles ship as soon as 5 days from the point of ordering. Our customer service representatives will walk you through the pole configuration process to ensure accuracy and quick order submission



*LSI Poles are certified to
UL and CSA standards.*



POLE TYPES

Square, Round and Round Tapered

Standard, Universal Replacement and Direct Burial options

Standard Square
4", 5", 6"



Standard Round
4", 5"



Standard Round
Tapered



Universal Square
4", 5", 6"



Universal Round
4", 5"



Universal Round
Tapered



Direct Burial Square
4", 5"



Direct Burial Round
4", 5"





UNMATCHED DURABILITY

Stands Up to Harsh Environments

Designed and engineered for durability and provided as standard with our oven-baked DuraGrip Protection System. Also available with LSI's proprietary DuraGrip+ Protection System for unmatched corrosion protection and extended warranty.

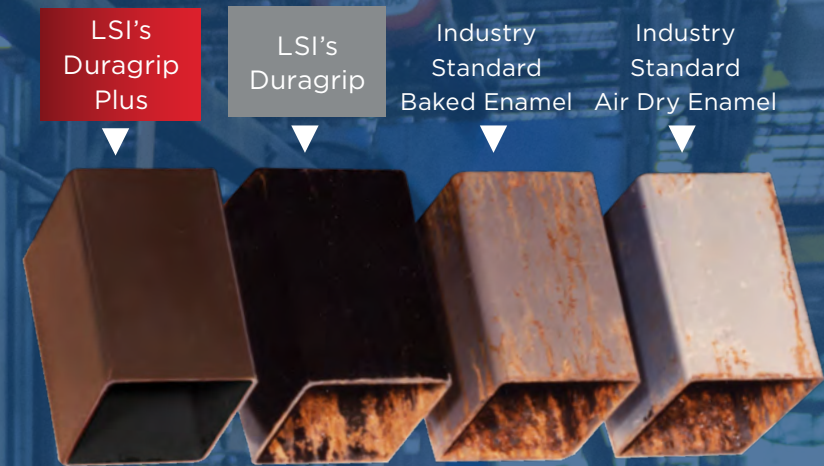

Poles After 1000hrs of Salt Spray Test

5-year standard warranty with available upgrade to 7-year

UNIVERSAL REPLACEMENT POLES

Offering a wide range of standard slotted base plates to accommodate existing anchor bolt circles in retrofit applications. Custom base plate capability for specific anchor bolt requirements.

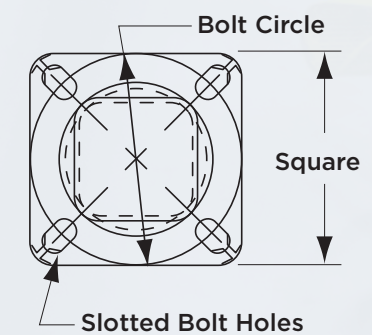

BRACKETS

Full line of brackets, including universal mounting types, for a wide number of applications.



The Universal Mounting Bracket allows for seamless integration of LSI Luminaires onto existing or new construction poles. The UMB bracket was designed specifically for square or round (tapered/ straight) poles with (2) mounting hole spaces between 3.5" to 5".

ANCHOR BOLTS

Available in Zinc and Galvanized options. Anchor bolts can be shipped prior to the pole for installation.

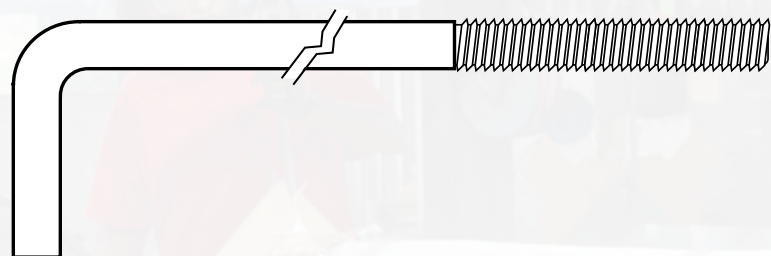

Available Sizes:
 3/8" X 10" Galvanized Steel
 3/4" X 30" Steel / 3/4" X 30" Galvanized (Partially)
 1" X 36" Steel / 1" X 36" Galvanized (Partially)
 1-1/4" X 42" Galvanized (Partially)

DRILLING PATTERNS

Poles are pre-drilled with standard LSI fixture drill patterns. Custom drill patterns to accommodate competitor fixtures available.

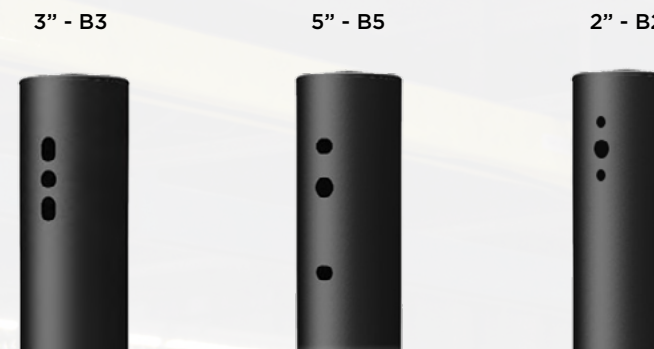

FIXTURE CONFIGURATIONS

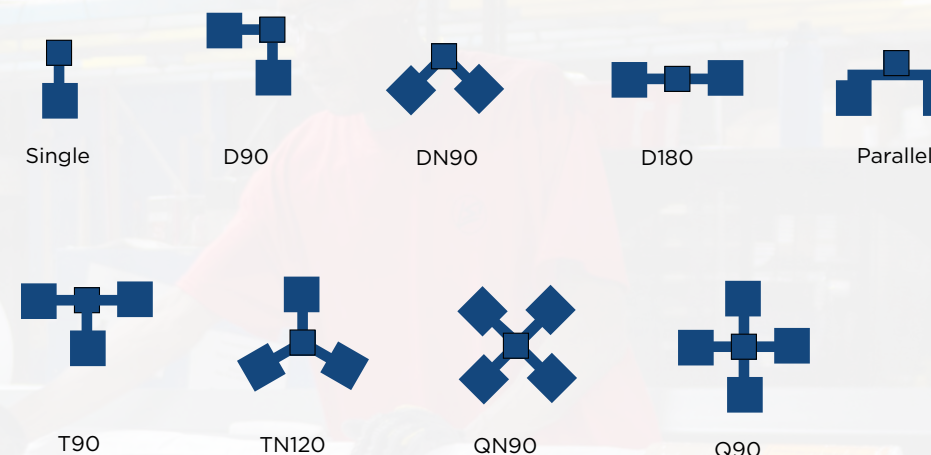

CONDUIT RACEWAY

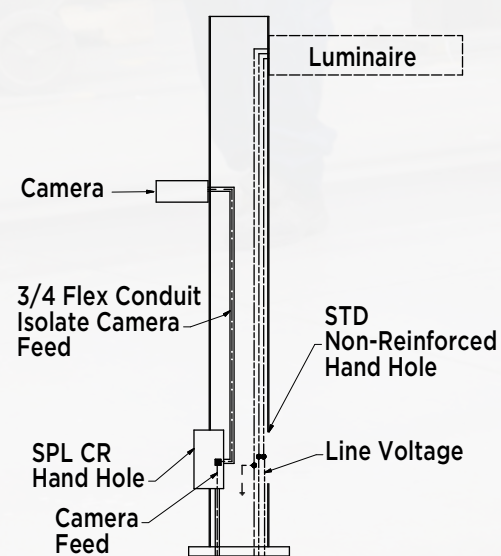

Easy to customize pole for low power accessories to avoid electronic interference.

Available on Standard and Universal Square Poles

Single and Dual (D180) Mounting Configurations

Internal 3/4" flex conduit for easy wire pulls.

Isolated Raceway - Separates Low and High Voltage

Example Applications:

- Surveillance
- Campus Call Boxes
- Wi-fi Extenders

EPA

LSI utilizes the ASCE 7-10 wind speed map for EPA values. All LSI Poles and Fixtures have calculated EPA values for ease of application verification to ensure the combination of pole, bracket, and fixture are suitable for the wind speed location.

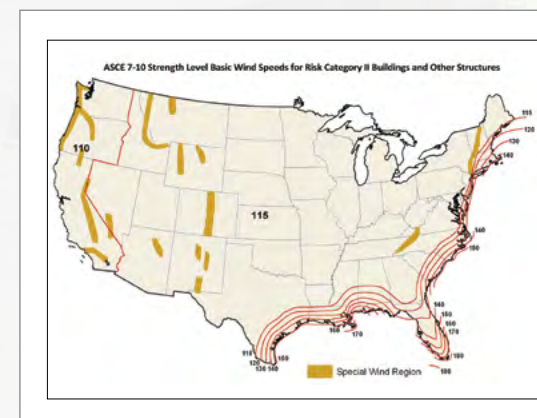

Pole Vibration

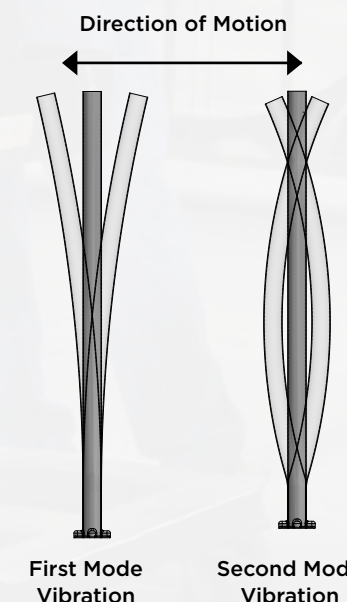

LSI is a leading manufacturer of poles for lighting applications, and we are committed to helping customers avoid issues from wind induced pole vibration. In areas with low speed, constant wind or light loaded poles greater than 25', a pole damper is recommended to minimize the risk of wind induced pole vibration.

Visit us online at www.lsicorp.com



MANUFACTURED
IN THE USA



LSI Industries Inc. 10000 Alliance Rd. Cincinnati, OH 45242 • www.lsicorp.com
(513) 72-3200 • ©2020 LSI Industries Inc. All Rights Reserved.

09/10/2021

MKVT.0527.B.721