



Calculite LED 1.75" downlights are available with optional Micro Vetro acrylic element accessories. Light levels from the original aperture provide 900 lm with input wattages up to 14W. Add detail and style to any space while maintaining architectural output at approximately 80%.

Project: _____
 Location: _____
 Cat.No: _____
 Type: _____
 Lamps: _____ Qty: _____
 Notes: _____

Complete luminaire = Frame + Trim or Micro Vetro (optional) + Installation Accessories (if required)

Frame / Light Engine (Needs approximately 7" of plenum depth for installation)

example: C2L09DL927RE1

Series	Lumen	Style	CCT / CRI	Installation	Input voltage
C2L	09	DL			
C2L Calculite LED 1.75"	09 900lm	DL Downlight	927 90CRI/2700K 930 90CRI/3000K 935 90CRI/3500K 940 90CRI/4000K	R Install from below	E1 120V Z10U Universal with 0-10V dimming

Wall washer and Linear spread trim

For wall washer & linear spread options, lenses are factory-assembled into specified reflector.

Trim (25°, 30°, 40° and 50° beam optics included with frame)

example: C2LDLBKP

Series	Style	Finish	Flange
C2L			
C2L Calculite LED 1.75" round	DL Downlight (50° cutoff) DLLS Downlight (75° cutoff) with linear spread lens LW Lensed wall washer ¹	BK Black (painted) CCZ Comfort clear diffuse CCZ Champagne bronze WH White (painted)	P Aperture-matching FT Flush mount ² (except for white finish) W White (painted)
C2X2L Calculite LED 1.75" square	DL Downlight (50° cutoff) LW Lensed wall washer ¹	BK Black (painted) WH White (painted)	FT Flush mount ² W White (painted)

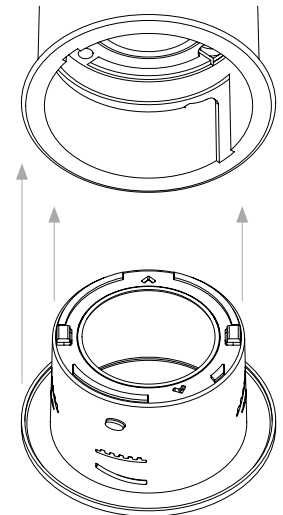

Reflector can be rotated 90° to ensure proper alignment. Friction-fit design maintains installation integrity.

Micro Vetro decorative elements (Trim above not required when ordered)

example: D2LR01

Series	Aperture	
D2L		
D2L Decorative LED 1.75" Micro Vetro elements	R01 Round acrylic w/aluminum insert R02 Round acrylic R03 Round glass S01 Square acrylic S02 Square glass	Installs into standard C2L frame. Comfort clear diffuse reflector is standard. Other finishes are available. Please contact factory.

Installation accessories³

C2LIC	IC frame (new construction)
C2LMP	New construction mounting pan
CA2FMR	Round aperture flush-mount mud-in ring
CA2X2FMR	Square aperture flush-mount mud-in ring

Beams Included

25°, 30°, 45° & 50° - For field installation.

- The 25° beam spread is recommended (A).
- Requires flush-mount mud-in ring (CA2FMR or CA2X2FMR).
- Recommended for specific applications, see page 2 for details.



C2L09 Calculite LED 1.75"

Downlight, 900lm

New Construction (N)

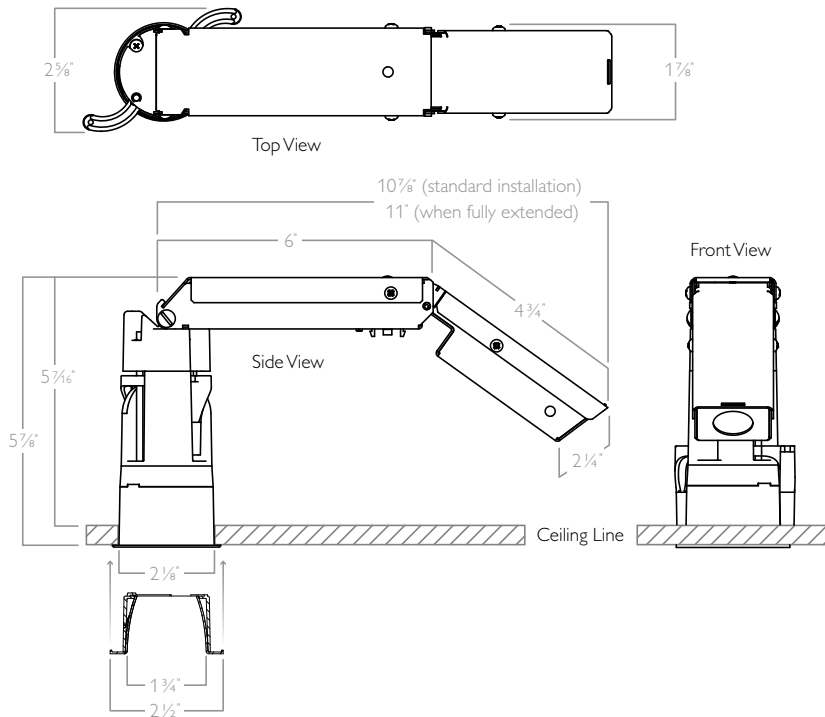

Flangeless mud-in ring (CA2FMR) accessory

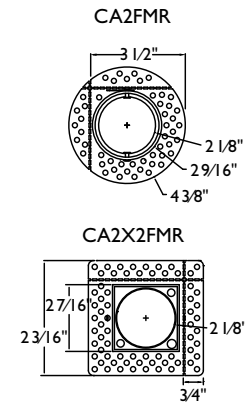

Flush-mount mud-in rings are required for gypsum applications.

Optional installation accessories

The standard C2L product offering is Non-IC, wet location listed* with no additional "frame-in kit" required. Listed below are additional frame options.

C2LIC

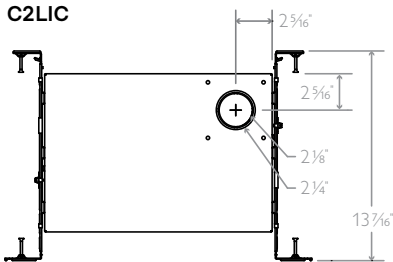

IC frame (new construction). Certified for use in Chicago Plenum applications. Includes bar hangers with preset screws which accommodate 12"-24" joist spacing. Bars also attach to T-bar ceilings.

- Width (min): 13 7/16"
- Length: 14 9/16"
- Depth: 9 5/16"

C2LMP

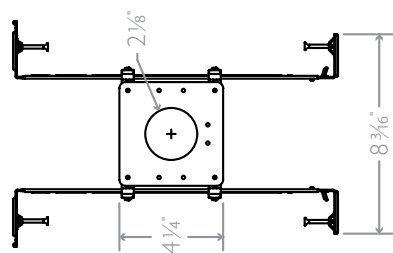

New construction mounting pan provides ability to pre-locate wiring for easy below-ceiling access. Includes bar hangers with preset screws which accommodate 12"-24" joist spacing. Bars also attach to T-bar ceilings. Width: 5.5", Length (min): 13.12"

CA2FMR

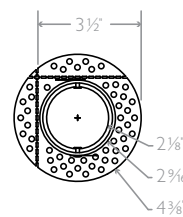

Round aperture flush-mount mud-in ring. Recommended for gypsum applications. Perforated flange allows installation only 1.4" from vertical structure, including corners.

CA2X2FMR

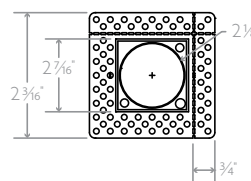

Square aperture flush-mount mud-in ring. Recommended for gypsum applications. Perforated flange allows installation only 1.4" from vertical structure, including corners. Square plate secures magnetically to mud-in ring. Tether included.

C2L09 Calculite LED 1.75"

Downlight, 900lm

Features

Aperture: 1.75" (44 mm) I.D., 2.50" (63mm) O.D.
Input power: 13.9W
Fixture output: Aluminum. Self-flanged.
 Provides 50° cutoff to source and source image.

Beam Spread options

Beam spread	Spacing criterion	Delivered lumens	Efficacy	CBCP
25°	0.4	1186 lm	85.3 lm/W	5537
30°	0.5	955 lm	68.7 lm/W	3451
45°	0.7	964 lm	69.4 lm/W	1848
50°	0.8	935 lm	67.3 lm/W	1268

Field replaceable optics: 4 TIR optics included for field installation and replacement (25°, 30°, 45° and 50° beams included).
Reflector cone: Aluminum. Provides 50° cutoff to source and source image. Twist and lock installation within frame ensures snug fit to ceiling.
Reflector flange: Thickness is 0.09" (2.4 mm). Width is (flanged) 0.37" (9.5 mm) and is (flush-mounted) 0.19" (4.8 mm).
Required depth: 6" (150 mm) plenum depth required for Non-IC installs.
Ceiling cutout: 2.13" (54mm).
Thick ceiling capability: 0.38" – 2" (9.7 mm – 51 mm).
Fixture weight: 1.8 lbs.
Installation: Hinged design allows fixture installation from below ceiling. Two screws actuate pivoting installation arms. Vertical installation only (as shown in above drawings).
Field accessibility: Driver is field interchangeable/replaceable.

Electrical

Power connection: Integral connection between driver and LED array
Junction box: UL listed for 6 No 12 AWG, 90°C through branch circuit connectors. Allows inspection from below. Compatible with 2-1 conduit connector for daisy chaining.
Minimum starting temperature: -20°C
Maximum operating temperature: 60°C
Input voltage: 120/277V 0-10V; 120V ELV
Input frequency: 60Hz
Input current: ELV – 0.117A, 0-10V – 0.124A (120V), 0.06A (277V)
LED drive current: 1A
Power Factor: >0.9 THD: <20%
FCC rating: Part 15 / Class B driver

ENERGY STAR®

C2L09DL930E1 / C2LDLCCD*	C2LIC / C2L09DL930E1 / C2LDLCCD*
C2L09DL930E1 / C2LDLWH*	C2LIC / C2L09DL930E1 / C2LDLWH*
C2L09DL935E1 / C2LDLCCD*	C2LIC / C2L09DL935E1 / C2LDLCCD*
C2L09DL935E1 / C2LDLWH*	C2LIC / C2L09DL935E1 / C2LDLWH*
C2L09DL940E1 / C2LDLCCD*	C2LIC / C2L09DL940E1 / C2LDLCCD*
C2L09DL940E1 / C2LDLWH*	C2LIC / C2L09DL940E1 / C2LDLWH*
C2L09DL930RZ10U / C2LDLCCD*	C2LIC / C2L09DL930RZ10U / C2LDLCCD*
C2L09DL930RZ10U / C2LDLWH*	C2LIC / C2L09DL930RZ10U / C2LDLWH*
C2L09DL935RZ10U / C2LDLCCD*	C2LIC / C2L09DL935RZ10U / C2LDLCCD*
C2L09DL935RZ10U / C2LDLWH*	C2LIC / C2L09DL935RZ10U / C2LDLWH*
C2L09DL940RZ10U / C2LDLCCD*	C2LIC / C2L09DL940RZ10U / C2LDLCCD*
C2L09DL940RZ10U / C2LDLWH*	C2LIC / C2L09DL940RZ10U / C2LDLWH*

Technology

LES Array: Cree CoB
Photometric performance: Tested in accordance to IESNA LM-79-2008
Color consistency: 2 SDCM (max.)

Spectral power distribution

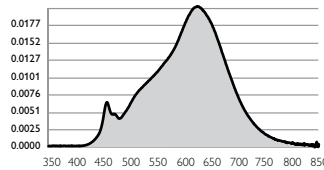

Chromaticity Diagram

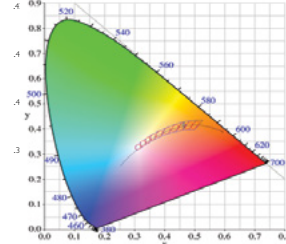

Color Rendering Index: 90 min, 92 typical

R1	R2	R3	R4	R5	R6	R7	R8	R9	R10	R11	R12	R13	R14
95.2	98.4	99.0	95.1	95.3	98.0	91.9	82.6	62.7	95.7	97.5	88.1	96.3	99.4

Dimming capability: ELV: Lightolier SR400RPC120 – Dims to 1%
 Lutron DVELV-300P-WH – Dims to 1%, 0-10V – Dims to 5%

Rated life

LES (Light Emitting Source): L90 at 90,700 hours (90% lumen maintenance). Based on IESNA LM-80-2008.
Driver: 50,000 hours

Labels and Listings

cULus, AirSeal, suitable for wet location.
 ENERGY STAR® certified and Title 24 rated.

Quick-ship: Lightolier is committed to providing customers with the products they need when they need them.

Warranty

5 year warranty on complete system.

Complete warranty available at: http://images.philips.com/is/content/PhilipsConsumer/PDFDownloads/United%20States/ODLI20150930_003-UPD-en_US-Philips-warranty-indoor-PLS-us.pdf



Title 24 JA8

C2LIC / C2L09DL9**E1 / C2LDLCCD*	C2LIC / C2L09DL9**RZ10U / C2LDLCCD*
C2LIC / C2L09DL9**E1 / C2LDLWH*	C2LIC / C2L09DL9**RZ10U / C2LDLWH*
C2LIC / C2L09DL9**E1 / C2LDCCZ*	C2LIC / C2L09DL9**RZ10U / C2LDCCZ*

C2L09 Calculite LED 1.75"

Downlight, 900lm

Narrow Spot beam, 900lm Engine, 85lm/W at 14 W

Candela Curve

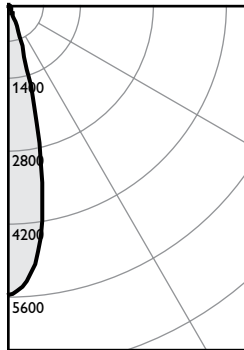

Frame: C2L09DL935RE1
Trim: C2LDLCCDP

Output lumens: 1186 lms
Input watts: 13.9 W
CRI: 90 min
CCT¹: 3500K
Spacing Crit.: 0.4
Beam Angle: 26°

Zonal summary

Zone	Lumens	%Luminaire
0-30	1119	94.4%
0-40	1172	98.8%
0-60	1184	99.8%
0-90	1186	100.0%

Angle	Mean CP	Lumens
0	5537	450
5	5144	
10	3827	
15	1945	
20	678	
25	256	137
30	148	
35	84	
40	37	53
45	9	
50	4	
55	2	
60	2	
65	1	1
70	1	
75	1	
80	0	
85	0	
90	0	0
	0	

Single unit data

Height to lighted plane	Initial center beam foot-candles	Beam diameter (ft)*
5'	221	2.0'
6'	154	2.4'
7'	113	2.8'
8'	87	3.2'
9'	68	3.6'

* Beam diameter is where foot-candles drop to 50% of maximum.

Multiple unit data - RCR 2

Spacing on center	Initial center beam foot-candles	Watts per sq. ft.
5'	a	0.62
6'		0.40
7'		0.29
8'		0.24
9'		0.19

38' x 38' x 10' Room, Workplane 2.5' above floor, 80/50/20% Reflectances

Efficacy: 85.3lm/w
Report#: 1445GFR

Adjustment factors

Finish	CCT
CCD = 100%	90CRI 4000K = 100%
CCZ = 88%	90CRI 3500K = 100%
WH = 95%	90CRI 3000K = 93%
BK = 00%	90CRI 2700K = 87%

Coefficients of utilization

Ceiling	80%				70%				50%				30%				0%
	70	50	30	10	50	10	50	10	50	10	50	10	50	10	50	10	0
RCR	Zonal cavity method - Effective floor reflectance = 20%																
Room Cavity Ratio	0	119	119	119	119	116	116	111	111	106	106	100	100	100	100	100	100
	1	115	113	111	109	111	108	107	104	103	104	103	101	97	94	91	88
	2	111	108	105	103	106	101	103	99	100	95	97	93	91	88	85	83
	3	108	103	100	97	102	96	100	95	97	91	95	90	88	85	83	81
	4	105	100	96	93	99	92	97	91	95	88	85	83	81	79	77	75
	5	102	96	92	89	95	89	94	88	92	87	85	83	81	79	77	75
	6	99	93	89	86	92	86	91	85	90	85	83	81	79	77	75	73
	7	96	90	86	83	89	83	88	83	87	82	81	79	77	75	73	71
	8	94	87	83	81	87	81	86	80	85	80	79	77	75	73	71	69
	9	91	85	81	78	85	78	84	78	83	78	77	75	73	71	69	67
	10	89	83	79	76	82	76	82	76	81	76	75	73	71	69	67	65

Spot beam, 900lm Engine, 69lm/W at 14 W

Candela Curve

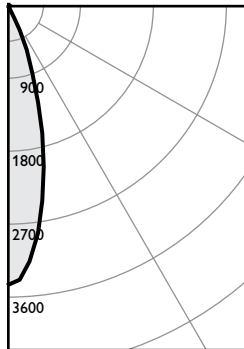

Frame: C2L09DL935RE1
Trim: C2LDLCCDP

Output lumens: 955 lms
Input watts: 13.9 W
CRI: 90 min
CCT¹: 3500K
Spacing Crit.: 0.5
Beam Angle: 29°

Zonal summary

Zone	Lumens	%Luminaire
0-30	903	94.5%
0-40	936	98.0%
0-60	952	99.6%
0-90	955	100.0%

Angle	Mean CP	Lumens
0	3451	278
5	3155	
10	2451	
15	1628	
20	912	
25	347	179
30	106	
35	47	
40	27	33
45	15	
50	6	
55	4	
60	3	
65	2	2
70	2	
75	1	
80	1	
85	0	
90	0	0
	0	

Single unit data

Height to lighted plane	Initial center beam foot-candles	Beam diameter (ft)*
5'	138	2.5'
6'	96	3.0'
7'	70	3.5'
8'	54	4.0'
9'	43	4.5'

* Beam diameter is where foot-candles drop to 50% of maximum.

Multiple unit data - RCR 2

Spacing on center	Initial center beam foot-candles	Watts per sq. ft.
5'	45.2	0.62
6'	29.7	0.40
7'	21.2	0.29
8'	17.7	0.24
9'	14.1	0.19

38' x 38' x 10' Room, Workplane 2.5' above floor, 80/50/20% Reflectances

Efficacy: 68.7lm/w
Report#: 1446GFR

Adjustment factors

Finish	CCT
CCD = 100%	90CRI 4000K = 100%
CCZ = 88%	90CRI 3500K = 100%
WH = 95%	90CRI 3000K = 93%
BK = 00%	90CRI 2700K = 87%

Coefficients of utilization

Ceiling	80%				70%				50%				30%				0%
	70	50	30	10	50	10	50	10	50	10	50	10	50	10	50	10	0
RCR	Zonal cavity method - Effective floor reflectance = 20%																
Room Cavity Ratio	0	119	119	119	119	116	116	111	111	106	106	100	100	100	100	100	100
	1	115	113	111	109	110	107	106	104	103	104	103	101	96	92	89	86
	2	111	107	104	101	105	100	102	98	99	96	96	92	89	86	84	82
	3	107	102	98	95	101	94	98	93	96	92	92	88	86	84	82	80
	4	103	98	93	90	97	90	95	89	93	88	86	84	82	80	78	76
	5	100	94	89	86	93	86	91	85	90	84	82	80	78	76	74	72
	6	97	90	86	83	89	82	88	82	87	81	80	78	76	74	72	70
	7	94	87	82	79	86	79	85	79	84	78	77	75	73	71	69	67
	8	91	84	80	77	83	76	82	76	82	76	74	72	70	68	66	64
	9	88	81	77	74	81	74	80	74	79	73	72	70	68	66	64	62
	10	86	79	74	72	78	71	78	71	77	71	70	68	66	64	62	60

1. Correlated Color Temperature within specs as defined in ANSI/NEMA/ANSI C78.377-2008: Specifications for the Chromaticity of Solid State Lighting Products.
2. Tested using absolute photometry as specified in LM79: IESNA Approved Method for the Electrical and Photometric Measurements of Solid-State Lighting Products.

C2L09 Calculite LED 1.75"

Downlight, 900lm

Narrow Flood beam, 900lm Engine, 69lm/W at 14W

Candela Curve

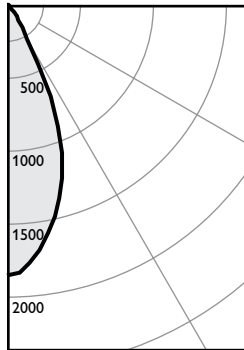

Frame: C2L09DL935RE1
Trim: C2LDLCCDP

Output lumens: 964 lms
Input watts: 13.9 W
CRI: 90 min
CCT¹: 3500K
Spacing Crit.: 0.7
Beam Angle: 44°

Zonal summary

Zone	Lumens	%Luminaire
0-30	842	87.4%
0-40	932	96.7%
0-60	958	99.4%
0-90	964	100.0%

Angle	Mean CP	Lumens
0	1848	
5	1769	163
10	1583	
15	1366	376
20	1078	
25	692	303
30	271	
35	135	90
40	68	
45	18	20
50	9	
55	7	6
60	5	
65	3	4
70	2	
75	2	2
80	1	
85	0	0
90	0	

Single unit data

Height to lighted plane	Initial center beam foot-candles	Beam diameter (ft)*
5'	74	3.5'
6'	51	4.2'
7'	38	4.9'
8'	29	5.6'
9'	23	6.3'

* Beam diameter is where foot-candles drop to 50% of maximum.

Multiple unit data - RCR 2

Spacing on center	Initial center beam foot-candles	Watts per sq. ft.
5'	44.8	0.62
6'	29.4	0.40
7'	21.0	0.29
8'	17.5	0.24
9'	14.0	0.19

38' x 38' x 10' Room, Workplane 2.5' above floor, 80/50/20% Reflectances

Efficacy: 69.3lm/w
Report#: 1447GFR

Adjustment factors

Finish	CCT
CCD = 100%	90CRI 4000K = 100%
CCZ = 88%	90CRI 3500K = 100%
WH = 95%	90CRI 3000K = 93%
BK = 00%	90CRI 2700K = 87%

Coefficients of utilization

Ceiling	80%				70%		50%		30%		0%	
	70	50	30	10	50	10	50	10	50	10	0	
RCR	Zonal cavity method - Effective floor reflectance = 20%											
Room Cavity Ratio	0	119	119	119	119	116	116	111	111	106	106	100
1	114	112	109	107	110	106	105	102	102	99	95	95
2	109	105	101	98	103	97	100	95	97	93	90	90
3	105	99	95	91	98	91	95	89	93	88	85	85
4	100	94	89	85	93	85	91	84	89	83	81	81
5	96	89	84	80	88	80	86	79	85	79	77	77
6	92	85	80	76	84	76	83	75	81	75	73	73
7	89	81	75	72	80	72	79	71	78	71	69	69
8	85	77	72	68	76	68	75	68	74	68	66	66
9	82	74	69	65	73	65	72	65	71	65	63	63
10	79	70	65	62	70	62	69	62	69	62	60	60

Flood beam, 900lm Engine, 69lm/W at 14W

Candela Curve

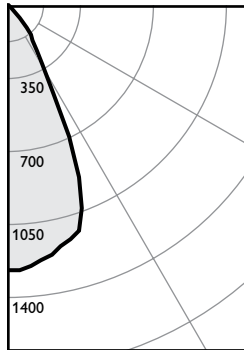

Frame: C2L09DL935RE1
Trim: C2LDLCCDP

Output lumens: 935 lms
Input watts: 13.9 W
CRI: 90 min
CCT¹: 3500K
Spacing Crit.: 0.8
Beam Angle: 51°

Zonal summary

Zone	Lumens	%Luminaire
0-30	747	80.0%
0-40	884	94.6%
0-60	928	99.3%
0-90	935	100.0%

Angle	Mean CP	Lumens
0	1268	
5	1250	118
10	1207	
15	1155	323
20	1032	
25	693	306
30	326	
35	212	136
40	143	
45	25	37
50	11	
55	8	7
60	6	
65	4	4
70	3	
75	2	2
80	1	
85	0	0
90	0	

Single unit data

Height to lighted plane	Initial center beam foot-candles	Beam diameter (ft)*
5'	51	4.0'
6'	35	4.8'
7'	26	5.6'
8'	20	6.4'
9'	16	7.2'

* Beam diameter is where foot-candles drop to 50% of maximum.

Multiple unit data - RCR 2

Spacing on center	Initial center beam foot-candles	Watts per sq. ft.
5'	43.0	0.62
6'	28.2	0.40
7'	20.1	0.29
8'	16.8	0.24
9'	13.4	0.19

38' x 38' x 10' Room, Workplane 2.5' above floor, 80/50/20% Reflectances

Efficacy: 68.7lm/w
Report#: 1448GFR

Adjustment factors

Finish	CCT
CCD = 100%	90CRI 4000K = 100%
CCZ = 88%	90CRI 3500K = 100%
WH = 95%	90CRI 3000K = 93%
BK = 00%	90CRI 2700K = 87%

Coefficients of utilization

Ceiling	80%				70%		50%		30%		0%	
	70	50	30	10	50	10	50	10	50	10	0	
RCR	Zonal cavity method - Effective floor reflectance = 20%											
Room Cavity Ratio	0	119	119	119	119	116	116	111	111	106	106	100
1	114	111	109	107	109	105	105	102	101	99	94	94
2	109	104	100	97	102	96	99	94	96	92	88	88
3	104	97	93	89	96	88	94	87	91	86	83	83
4	99	92	86	83	91	82	88	81	86	80	78	78
5	94	86	81	77	85	77	84	76	82	75	73	73
6	90	82	76	72	81	72	79	71	78	71	69	69
7	86	77	72	68	77	67	75	67	74	67	65	65
8	82	73	68	64	73	64	72	63	71	63	62	62
9	79	70	64	60	69	60	68	60	67	60	58	58
10	75	66	61	57	66	57	65	57	64	57	55	55

1. Correlated Color Temperature within specs as defined in ANSI_NEMA_ANSI C78.377-2008: Specifications for the Chromaticity of Solid State Lighting Products.
2. Tested using absolute photometry as specified in LM79: IESNA Approved Method for the Electrical and Photometric Measurements of Solid-State Lighting Products.

The information presented in this document is not intended as any commercial offer and does not form part of any quotation or contract.

